



INSTRUCTION MANUAL

CLT-D5880
CLT-D5882
CLT-D5883

5.8-GHz Cordless Telephone
with Caller ID & Visual Call Waiting



IMPORTANT

Charge the handset battery pack for a full 15-20 hours before using your cordless handset for the first time.

SANYO Canada Inc.
www.sanyo.ca

Introduction

Congratulations on your purchase of the CLT-D5880/CLT-D5882/CLT-D5883 cordless telephone from SANYO.

This phone is designed for reliability, long life, and outstanding performance utilizing the latest in 5.8 GHz technology.

Note:

Some illustrations in this manual may differ from the actual unit for explanation purposes.

Features

- 5.8GHz Digital Expandable
- Hands-Free Duplex Speakerphone in the Handset
- Caller ID/Call Waiting Deluxe (subscribe through local telephone company)
- 100 programmable Memory Locations
- Trilingual Display Options (English, French and Spanish)
- Intercom/Call Transfer Between Handsets (for multi handsets)
- 20 Distinctive Ring Options (10 ringer tones and 10 melody ringers)
- Mute and Hold Features
- Walkie-Talkie Mode (for multi handsets)
- Room/Baby Monitoring (for multi handsets)
- Battery Level Indicator
- Clock Display
- Animation Displays

Your SANYO 5.8-GHz cordless telephone is a fine quality home communications product. It is carefully designed and produced by a world leader of consumer and industrial electronics equipment. With proper maintenance and care, it will provide you with years of enjoyment and convenience.

5.8-GHz Technology

The clearest channel is automatically selected for each transmission. The phone selects one of over 10,000,000 digital security codes for the handset and base.

These features enhance your phone's security and also prevent unauthorized calls as a result of your phone being activated by other equipment.

CONTENTS

Introductioninside front cover
 Featuresinside front cover
 Controls and FunctionsE2

GETTING STARTED

Checking the Package ContentsE4
 Setting Up the PhoneE4
 Mounting the Base Unit On a WallE9

USING THE INTERFACE

Display and IconsE11
 Soft Key FunctionE13
 Main Menu OptionsE14
 Setting Menu OptionsE15

BASICS

Making and Receiving CallsE24
 Call WaitingE26
 Placing a Call on HoldE26
 Redialing a CallE27
 Adjusting the Ringer, and
 Earpiece and Speaker VolumeE28
 Temporarily Muting the RingerE28
 Mute MicrophoneE28
 Tone Dialing Switch-overE29
 Traveling Out of RangeE29
 Privacy ModeE29
 Using One Touch
 Voice Mail AccessE30

DIRECTORY

Phonebook (Storing Phone Numbers,
 Names, Distinctive Rings and
 Speed Dial)E31
 Chain DialingE32
 Steps for Entering Names and
 Special CharactersE33
 Viewing the PhonebookE35
 Making Calls Using the Phonebook ...E36
 Speed DialingE36
 Editing or Erasing a Stored Name,
 Phone Number, Distinctive Ring and
 Speed DialE37
 Copying Phonebook Locations
 (CLT-D5882/CLT-D5883 only)E38

CALLER ID FEATURES

Caller ID and CIDCW
 (Caller ID on Call Waiting)E39
 Viewing the Caller ID ListE41
 Deleting a Caller ID MessageE42
 Using the Caller ID Message ListE43
 Call Waiting Deluxe FeaturesE45

MULTI-HANDESET FEATURES

Using the Walkie-Talkie Mode
 (CLT-D5882/CLT-D5883 only)E46
 3-Way ConferencingE47
 Intercom/Call Transfer FeatureE47

ADDITIONAL INFORMATION

Changing the Digital Security Code ...E49
 Find HandsetE49
 Installing the BeltclipE50
 Optional HeadsetE50
 Note on Power SourcesE51
 TroubleshootingE52
 Technical InformationE54

THE SANYO

COMFORT WARRANTYE55

MAIN MENU FLOW CHARTE57

Getting Started

Using the
Interface

Basics

Directory

Caller ID
Features

Multi-handset
Features

Additional
Information

Controls and Functions

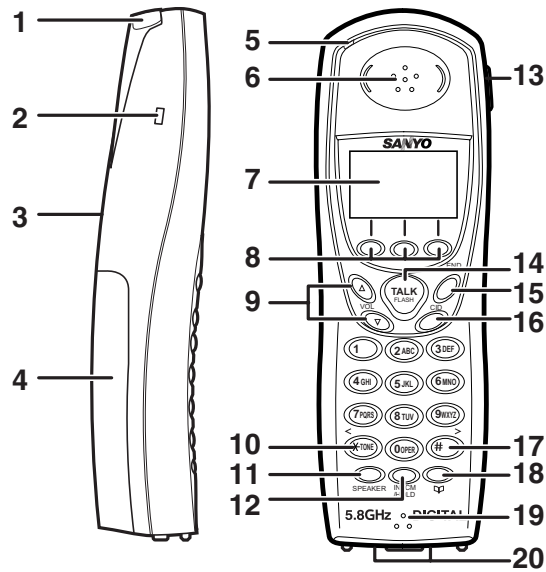

- | | |
|------------------------------------|-------------------------------|
| 1. Handset Antenna | 11. SPEAKER |
| 2. Beltclip Hole | 12. INTCM (intercom) /HOLD |
| 3. Speakerphone Speaker and Ringer | 13. Headset Jack Cover |
| 4. Handset Battery Compartment | 14. TALK/FLASH |
| 5. New Message LED | 15. END |
| 6. Handset Earpiece | 16. CID (Caller ID) |
| 7. LCD Display | 17. #/> (right cursor) |
| 8. Soft Keys | 18. ☞ (phonebook) |
| 9. VOL ▲ / ▼ (volume up/down) | 19. Handset Microphone |
| 10. * /TONE/ < (left cursor) | 20. Handset Charging Contacts |

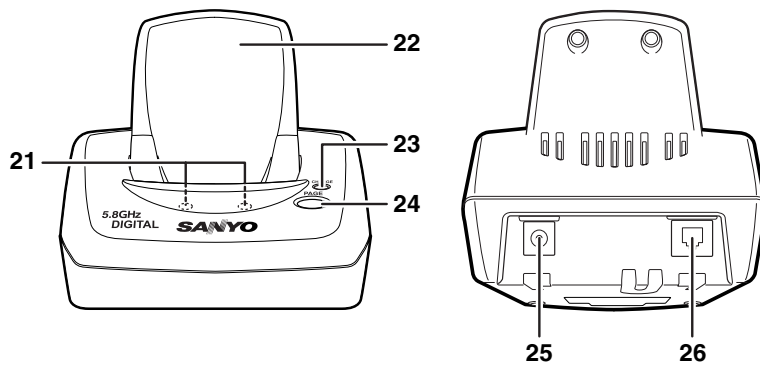

- 21. Base Charging Contacts
- 22. Base Antenna
- 23. Base CHARGE LED

- 24. PAGE
- 25. DC IN 9V Jack
- 26. TEL LINE Jack

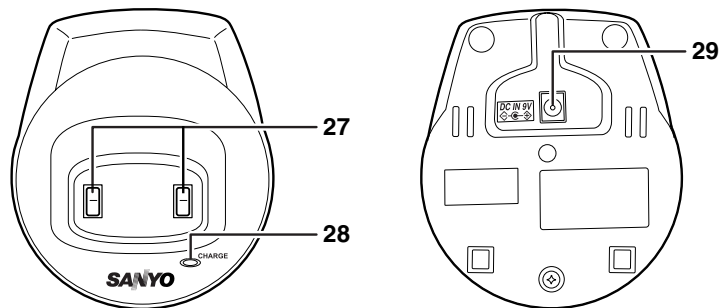

For multi-handset packs only

- 27. Charging Contacts
- 28. Charger CHARGE LED
- 29. DC IN 9V Jack

GETTING STARTED

Checking the Package Contents

Make sure you have received the following items in the package.

For CLT-D5880

- Base unit (1)
- AC adapter (1)
- Telephone cord (1)
- Handset (1)
- Rechargeable battery (1)
- This instruction manual (1)
- Belt clip (1)
- Wall mount bracket (1)
- Battery order sheet (1)

For CLT-D5882

- Base unit (1)
- AC adapters (2)
- Telephone cord (1)
- Handsets (2)
- Rechargeable batteries (2)
- This instruction manual (1)
- Belt clips (2)
- Charger (1)
- Wall mount bracket (1)
- Battery order sheet (1)

For CLT-D5883

- Base unit (1)
- AC adapters (3)
- Telephone cord (1)
- Handsets (3)
- Rechargeable batteries (3)
- This instruction manual (1)
- Belt clips (3)
- Chargers (2)
- Wall mount bracket (1)
- Battery order sheet (1)

Setting Up the Phone

Do the following steps:

- A. Choose the best location
- B. Install the rechargeable battery pack into the handset
- C. Connect the base unit and charge the handset

A. Choose the best location

Here are some important guidelines you should consider:

- The location should be close to both a phone jack and a continuous power outlet that is not switchable.
- Keep the base and handset away from sources of electrical noise such as motors, microwave ovens, and fluorescent lighting.
- The base should be placed in an open area for optimum range and reception.
- The base can be placed on a desk, tabletop, or mounted on a standard wall plate.

Note:

- If your home has specially wired alarm equipment connected to the telephone line, be sure that installing the system does not disable your alarm equipment. If you have questions about what will disable your alarm equipment, contact your telephone company or a qualified installer.

GETTING STARTED

B. Install the rechargeable battery pack into the handset

The handset is powered by a rechargeable battery pack.

The battery recharges automatically when the handset is placed in the base unit or charging cradle.

IMPORTANT

Use only the SANYO rechargeable battery pack supplied with your cordless telephone.

Charge the handset battery pack for at least 15-20 hours before using your new cordless telephone for the first time! To maximize the charge capacity of your battery pack, **DO NOT** plug the telephone cord into the base unit and wall jack until the battery is fully charged.

- 1** Press down on the handset battery case cover (use the finger indentation for a better grip) and slide the cover downward to remove.
- 2** Plug the battery pack connector (red & black wires) into the jack inside the battery compartment. (The connector notches fit into the grooves of the jack only one way.) Match the wire colors to the polarity label in the battery compartment, connect the battery and listen for a click to ensure connection.
- 3** Make sure you have a good connection by pulling slightly on the battery wires. If the connection is secure, the battery jack will remain in place.
- 4** Place the battery case cover back on the handset by sliding it upwards until it clicks into place.

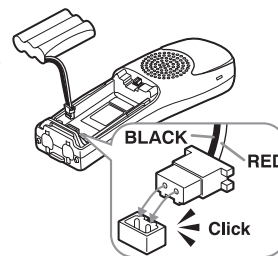
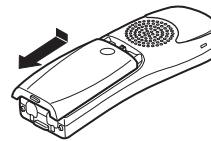

GETTING STARTED

Low Battery Alert

When the battery pack is very low and needs to be charged, the phone is programmed to eliminate functions in order to save power. If the phone is not in use, "Low Battery" appears on the LCD and none of the keys will operate.

If the phone is in use, "Low Battery" flashes and the handset beeps. Complete your conversation as quickly as possible and return the handset to the base unit for charging.

Note:

- Even when the battery pack is not being used, it will gradually discharge over a long period of time.

Cleaning the Battery Charging Contacts

To maintain a good charge, it is important to clean the charging contacts on both the handset and the base unit once a month. Use a clean pencil eraser or superfine steel wool. Avoid touching the cabinet area of the phone or scratches may occur.

Caution: Do not use paint thinner, benzene, alcohol, or other chemical products. Doing so may discolor the surface of the telephone and damage the finish.

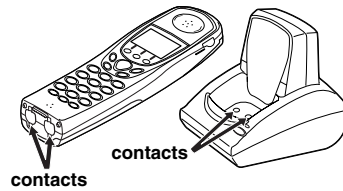

Terminology

- **Talk Mode -**
The handset is off the base and the **TALK/FLASH** key has been pressed, enabling a dial tone.
- **Standby Mode -**
The handset is not in use, off the base, and the **TALK/FLASH** key has not been pressed. A dial tone is not present.

GETTING STARTED

C. Connect the base unit and charge the handset

- 1 Connect the AC adapter to the **DC IN 9V** jack and to a standard 120V AC wall outlet.
- 2 Set the base on a desk or tabletop.
- 3 Place the handset in the base unit for 15-20 hours without interruption. The base unit's LED light (labeled **CHARGE**) illuminates once the handset is placed in the base. The LED light will illuminate whether the battery pack is connected or not.

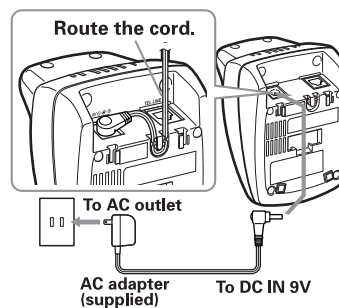

If the base **CHARGE** LED light does not illuminate:

- Check to see if the AC adapter is plugged into the base unit and the electrical wall outlet properly.
- Check to see if the handset is sitting correctly in the base and making good contact with the base unit's charging contacts.

Notes:

- Connect the AC adapter to a continuous power supply.
- Place the base unit close to the AC outlet so that you can unplug the AC adapter easily.
- It is normal for the handset and base to get warm, when the handset is charging in the base unit.

IMPORTANT

- Use only the supplied SANYO AC adapter. Do not use any other AC adapter.
- Do not place the power cord so that it creates a trip hazard or where it could become damaged and create a fire or electrical hazard.

GETTING STARTED

- 4** Once the handset battery pack is fully charged, connect the telephone line cord to the **TEL LINE** jack and to a telephone outlet.

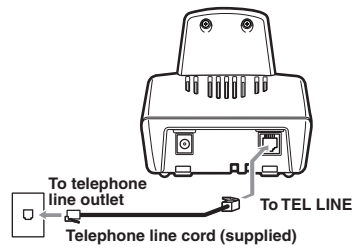

Tip:

If your telephone outlet isn't modular, contact your telephone company for assistance.



Modular

Connecting the Charger (for CLT-D5882/CLT-D5883)

- 1** Connect the AC adapter to the **DC IN 9V** jack and to a standard 120V AC wall outlet.
- 2** Set the charger on a desk or tabletop, and place the handset in the charger with the keypad facing forward. (See "B. Install the rechargeable battery pack into the handset" on page E5.)

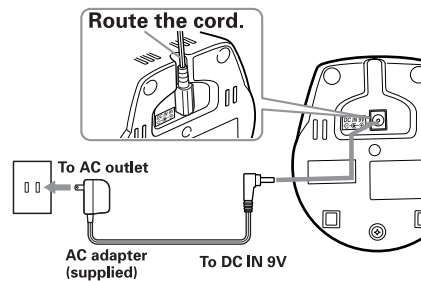

Note:

- Charge the handset battery pack for at least 15-20 hours before using your new cordless telephone for the first time.

Register the 2nd and 3rd units.

GETTING STARTED

Mounting the Base Unit On a Wall

Standard Wall Plate Mounting

This phone can be mounted on any standard wall plate.

- 1** Put the AC adapter and the telephone line cord through the hole on the wall mount adapter.
- 2** Plug the AC adapter into the **DC IN 9V** jack.
- 3** Plug the telephone line cord into the **TEL LINE** jack.
- 4** Slide the wall mount adapter into the notches on the base.
- 5** Plug the AC adapter into a standard 120V AC wall outlet. Hook the cord on the notch of the wall mount adapter.
- 6** Plug the telephone line cord into the telephone outlet. Hook the cord on the notch of the wall mount adapter.
- 7** Align the mounting slots on the base with the mounting posts on the wall. Then push in and down until the phone is firmly seated.

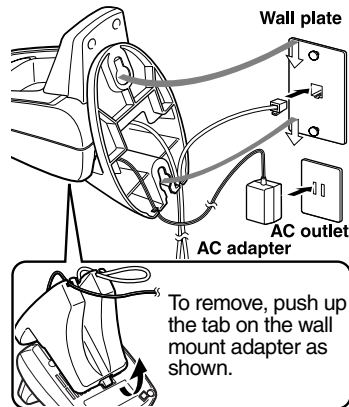
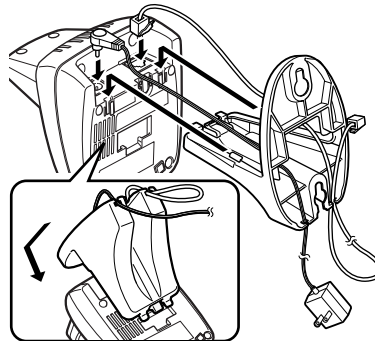

IMPORTANT

DO NOT use an AC outlet controlled by a wall switch.

GETTING STARTED

Direct Wall Mounting

If you don't have a standard wall plate, you can mount your phone directly to the wall. Before doing this, consider the following:

- Avoid electrical cables, pipes, or other items behind the mounting location that could cause a hazard when inserting screws into the wall.
- Try to mount your phone within 5 feet of a working phone jack to avoid excessive cable lengths.
- Make sure the wall material is capable of supporting the weight of the base and handset.
- Use #10 screws (minimum length of 1-3/8 inches) with anchoring devices suitable for the wall material where the base unit will be placed.

- 1** Insert two mounting screws into the wall, (with their appropriate anchoring device), 3-15/16 inches apart.

Allow about 1/8 of an inch between the wall and screw heads for mounting the phone.

- 2** Refer to steps 1 through 7 on page E9 to mount the telephone.

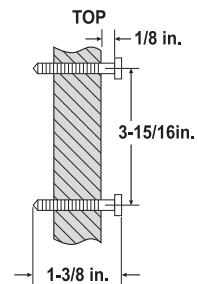

USING THE INTERFACE

Display and Icons

Example of the standby mode display

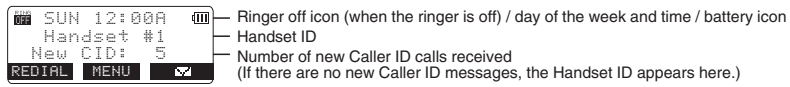

Icon	Appears During	Description
	Standby/Talk	Battery icons indicate the handset battery status. This icon changes depending on the battery status (empty, low, medium and full).
	Standby	The Ringer off icon indicates that ringer is turned off.
	Talk	The Mute icon appears when you mute the handset.
	Talk	The Speaker icon appears when the handset speaker phone is used.
	Talk	The Privacy icon appears when the Privacy Mode is turned on.

USING THE INTERFACE

Animation Displays

The handsets have a variety of animation displays. Below are examples of the animation screens and what they mean:

Turning on the phone

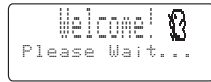

Hanging up the phone



Confirmation (Done!)



Deleting (Deleted!)

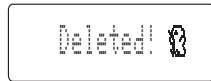

Making a call



Find Handset/
Paging the Handset



Also, the animation display changes depending on the ringer volume setting.



Out of Range



Unavailable



Low Battery



USING THE INTERFACE

Soft Key Function

"Soft" keys are keys that change function during the operation of the phone. There are three soft keys on each handset. Soft Keys allow you to:

- Access the main menu
- Access stored Caller ID messages
- Set up CIDCW options (Caller ID on Call Waiting)
- Redial one of the last three numbers dialed from the handset
- Store or edit phone numbers
- Access Voice mail waiting

Note: The soft keys will not appear while the handset is charging.

The function of each soft key is determined by the icon that appears directly above it. For example, when the handset is in standby mode, pressing soft key 1 will redial the last dialed number. When the handset is in talk mode, pressing soft key 1 will mute the microphone.

Complete information on the features controlled by the soft keys can be found under each feature.

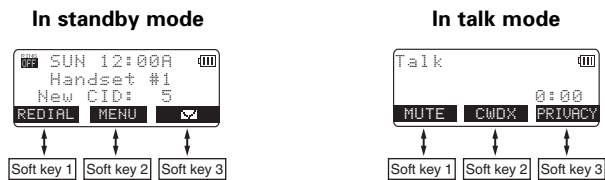

USING THE INTERFACE

Main Menu Options

Your phone has five main menu options: **Walkie-Talkie Mode, Room/Baby Monitor, Handset Setup, Global Setup** and **Deregister HS**.

Default Settings

The default settings set from the factory match the features that most people use. You may not need to change them. However, there are a number of options you must set and entries you must make in memory to take full advantage of all the phone features. The table below lists the default settings.

Function	Default Settings
Edit Voice Mail	None
Ringer Tone	Flicker
Distinctive Ring	On
Automatic Talk (Auto Talk)	Off
Anykey Answer	Off
Banner	" "
Language	English
Contrast	level 5
Key Touch Tone	On
Animation Screen	On
Day & Time	SUN 12:00 AM
CIDCW	CW on/CWDX off
Area Code	None
Dial Mode	Tone
Voice Mail Tone	On

Notes:

- For Global Setup and Deregister HS menu options, make sure the line is not in use and the handsets are within range of the base.
- Main menu flow chart is provided on page E57.

USING THE INTERFACE

Setting Menu Options

Below are some tips for using the software interface on your phone.

- Press the **MENU** soft key to access the main menu.
- Use **VOL/▲** and **VOL/▼** to scroll through options.
- Press the **OK** soft key to make a selection.
- Press the **BACK** soft key to return to the previous screen.
- Press **END** to exit the menu.



Walkie-Talkie Mode

In Walkie-Talkie mode, a pair of handsets can function as two-way radios. Walkie-Talkie mode allows two handsets to communicate with each other without the base unit or a telephone line. Use them at sporting events or while shopping to stay in contact with family members or friends. You must set both handsets to Walkie-Talkie mode to activate this feature.

Note:

- You must have at least two handsets to use Walkie-Talkie mode.

Using Walkie-Talkie Mode (for CLT-D5882/CLT-D5883)

- 1 Press the **MENU** soft key and select the DirectLink Mode menu. To enter DirectLink mode press [ENTER] appears.
 
- 2 Press the **ENTER** soft key to enter Walkie-Talkie mode. You will hear a confirmation tone, and DirectLink Mode Complete appears.
- 3 To return to normal mode, press the **CANCEL** soft key and then the **OK** soft key, or return the handset to the cradle.

USING THE INTERFACE

Room/Baby Monitor

This feature allows you to monitor sounds in another room. Place a handset in the room you wish to monitor; it will function as a microphone. A second handset can be set to function as a remote speaker, allowing you to monitor sounds in the room.

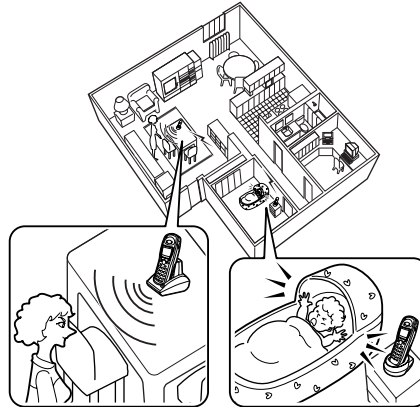

Using Room/Baby Monitor

- 1** Press the **MENU** soft key and select the Room Monitor menu. To Room Monitor appears.
- 2** Select the handset you want to monitor by using **VOL/▲** or **VOL/▼**.
- 3** Press the **OK** soft key.
RoomMonitor appears, and you hear sounds in the room where the handset is installed.
- 4** To turn off the Room Monitor, press the **END** soft key, or **END**.



Notes:

- This feature only works when the handset(s) is within the range of the base.
- You must have at least two handsets to use Room/Baby Monitor.

During room monitor, if you receive a call, you will hear beeps from the earpiece or speaker. Press **TALK/FLASH** to answer the call.

USING THE INTERFACE

Handset Setup

The following submenu options must be set separately for each handset.

Programming your Voice Mail Access Number

- 1 Press the **MENU** soft key. Select the Handset Setup menu, and then the Edit Voice Mail submenu. Edit V_mail No. appears.
 
- 2 Enter your personal access number using the number keypad (0-9), * /TONE/ <, # / >, the **DELETE** soft key, or the **PAUSE** soft key (up to 20 digits).
- 3 Press the **OK** soft key. You will hear the confirmation tone.

To delete the current Voice Mail Access Number, delete all numbers in step 2 using the **DELETE** soft key and the **OK** soft key.

Selecting a Ringer Tone

Ringer Tone lets you choose from 10 ringer tones or 10 melodies:

- Ringers (Flicker, Clatter, Soft Alert, Wake Up, Light Bug, Beep Boop, Tone Board, Chip Chop, Party Clap, Reminder)
- Melodies (Beethoven's Symphony #9 [Beethoven9], For Elise [Elise], We Wish You A Merry Christmas [Merry- Xmas], Home Sweet Home [Hm Swt Hm], Lorri Song #6 [Lorri Song], When Irish Eyes Are Smiling [Irish Eyes], Aura Lee, Let Me Call You Sweet Heart [Sweetheart], Star Spangled Banner [Star Spngl], Old MacDonald [Old MacDld])

You must set the separate ringer tone on each handset.

- 1 Press the **MENU** soft key. Select the Handset Setup menu, and then the Ringer Tone submenu.
- 2 Press **VOL/▲** or **VOL/▼** to move the pointer. You will hear the ringer or melody as you scroll through the options.
 
- 3 When you reach the ringer tone you want, press the **OK** soft key. You will hear a confirmation tone.

USING THE INTERFACE

Distinctive Ringer Setup

Distinctive Ringer allows you to assign a designated ring tone to a stored phonebook number (100 stored locations available). When a call is received and the Caller ID information matches the information in one of the phonebook memory locations, the phone uses the distinctive ring assigned to that particular caller. You can assign distinctive rings to multiple phonebook memory locations. Switching the setting to Distinctive Off disables distinctive ringing: all incoming calls will have a normal ring tone. Switching to Distinctive On activates all programmed distinctive ring memory locations.

1 Press the **MENU** soft key. Select the Handset Setup menu, and then the Distinctive Ring submenu.



2 Press **VOL/▲** or **VOL/▼** to select On or Off.

3 Press the **OK** soft key. You will hear a confirmation tone.

Setting the Automatic Talk (Auto Talk)

Automatic Talk (Auto Talk) allows you to answer the phone simply by removing the handset from the cradle. You do not have to press any buttons to answer the call.

1 Press the **MENU** soft key. Select the Handset Setup menu and then the Automatic Talk submenu.



2 Press **VOL/▲** or **VOL/▼** to select On or Off.

3 Press the **OK** soft key. You will hear a confirmation tone.

Setting the Anykey Answer

Anykey Answer allows you to answer the phone by pressing any number key, *** /TONE/ <**, or **# / >** on the handset.

1 Press the **MENU** soft key. Select the Handset Setup menu, and then the Anykey Answer submenu.



2 Press **VOL/▲** or **VOL/▼** to select On or Off.

3 Press the **OK** soft key. You will hear a confirmation tone.

USING THE INTERFACE

Setting the True Banner

True Banner lets you customize the name your handset displays.

The name will be displayed on the LCD screen during standby mode, Intercom, Intercom Hold, Room Monitor and Copy Phonebook operation. The banner name will be displayed on the receiving handset as well.

- 1 Press the **MENU** soft key. Select the Handset Setup menu, and then the Banner submenu.
- 2 Use the number keypad (0-9), ***** /TONE/ < , #/ > , or the **DELETE** soft key to enter or edit the name.
- 3 Press the **OK** soft key. You will hear a confirmation tone.



Selecting a Language

Language selects which language the menu display will use. Choose from English, French, or Spanish.

- 1 Press the **MENU** soft key. Select the Handset Setup menu, and then the Language submenu.
- 2 Press **VOL/▲** or **VOL/▼** to choose "English", "Français" (French), or "Español" (Spanish).
- 3 Press the **OK** soft key. You will hear a confirmation tone.

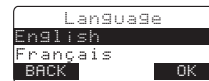

Adjusting the LCD Contrast

Contrast adjusts the handset LCD brightness. Choose one of the 10 levels for optimum viewing.

- 1 Press the **MENU** soft key. Select the Handset Setup menu and then the Contrast submenu.
- 2 Press **VOL/▲** or **VOL/▼** to adjust the contrast of the LCD (10 levels).
- 3 Press the **OK** soft key. You will hear a confirmation tone.



USING THE INTERFACE

Setting the Key Touch Tone

Key Touch Tone is the tone your keypad makes when keys are pressed. You can turn this tone on or off.

- 1 Press the **MENU** soft key. Select the Handset Setup menu and then the Key Touch Tone submenu.
- 2 Press **VOL/▲** or **VOL/▼** to select On or Off.
- 3 Press the **OK** soft key. You will hear a confirmation tone.



Setting the Animation Screen

The Animation screen displays animation on the handset LCD. The animations will be displayed on the LCD screen during a call, ringer volume setting, when you hang up, and so on.

- 1 Press the **MENU** soft key. Select the Handset Setup menu and then the Animation Screen submenu.
- 2 Press **VOL/▲** or **VOL/▼** to select On or Off.
- 3 Press the **OK** soft key. You will hear a confirmation tone.



See "Animation Displays" on page E12 for all the available screens.

USING THE INTERFACE

Global Setup

If you change one of the global settings, you change that setting for all registered handsets. Only one handset can change global settings at a time.

Setting Day and Time

Day & Time sets the day and time of your display.

- 1 Press the **MENU** soft key. Select the Global Setup menu, and then the Day & Time submenu option. 
- 2 Press **VOL/▲** or **VOL/▼** to select the day of the week, and then the **→** soft key.
- 3 Press **VOL/▲** or **VOL/▼** to set hour, and then press the **→** soft key.
- 4 Press **VOL/▲** or **VOL/▼** to set minute, and then press the **→** soft key.
- 5 Press **VOL/▲** or **VOL/▼** to choose **AM** or **PM**, and then press the **SAVE** soft key. You will hear a confirmation tone.

Note:

- For setting the Day and Time, the idle time-out is extended to 2 minutes.

Setting CIDCW (Caller ID on Call Waiting)

Caller ID on Call Waiting (CIDCW) displays the name and number of an incoming call while you are on the line. Call Waiting Deluxe (CWDX) allows you to handle call waiting calls in seven different ways.

- 1 Press the **MENU** soft key. Select the Global Setup menu, and then the CIDCW submenu. 
- 2 Press **VOL/▲** or **VOL/▼** to select **CW On/CWDX On**, **CW On/CWDX Off**, or **CW Off/CWDX Off**, and then press the **OK** soft key. You will hear a confirmation tone.

USING THE INTERFACE

Setting the Area Code

If you enter a 3-digit area code number in the "Area Code" option, your local area code does not appear in the Caller ID message. For calls received from outside your local area code, you will see a full 10-digit number.

- 1 Press the **MENU** soft key. Select the Global Setup menu, and then the Area Code submenu.
- 2 Press the number keypad (0-9) to enter a 3-digit area code.
- 3 Press the **OK** soft key. You will hear a confirmation tone.

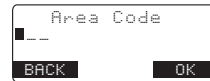

Notes:

- If your calling area requires 10-digit dialing, do not program this option.
- If the area code has already been stored in memory, the stored area code will be displayed. To change it, use the **DELETE** soft key and number keys to enter the new area code.

Setting the Dial Mode

Sets the dial mode to tone or pulse. Most phone systems use tone dialing; the default setting is tone dialing. Set the dialing mode to match the dialing system used by your local phone service.

- If you are not sure of your dialing system, set the unit to tone dialing. Make a trial call. If the call connects, leave the setting as is; otherwise set the unit to pulse dialing.
- If your phone system requires pulse dialing and you need to send DTMF tones in certain situations during a call, you can switch over to tone dialing (refer to "Tone Dialing Switch-over" on page E29).

- 1 Press the **MENU** soft key. Select the Global Setup menu, and then the Dial Mode submenu.
- 2 Press **VOL/▲** or **VOL/▼** to select Tone or Pulse (the initial setting is Tone).
- 3 Press the **OK** soft key. You will hear a confirmation tone.



USING THE INTERFACE

Setting Voice Mail Tone

Voice Mail Tone sets the voice mail tone. If your service does not support SDT message signal, set your VMWI (Visual Message Waiting Indicator) not to detect SDT message signal.

- 1 Press **MENU** soft key. Select the Global Setup menu, and then the Voice Mail Tone Submenu.
- 2 Press **VOL/▲** or **VOL/▼** to set the voice message indication (SDT message signal) to **On** or **Off**.
- 3 Press the **OK** soft key. You will hear a confirmation tone.



De-register the Handset

Deregister HS clears the handset's ID from the main base unit or the base ID from the handset. You will usually only deregister the handset if you are having a problem with your phone or if you need to change the digital security code. (see page E49).

- 1 In standby mode, select Deregister HS in the menu and press the **OK** soft key. Deregister HS? appears.
- 2 Press **VOL/▲** to select **Yes** and then the **OK** soft key.

When de-registration is complete you will hear a confirmation tone, and Deregistration Complete appears.
- 3 After de-registering the handset, place the handset to the base to register. You must re-register the handset before you can use it.

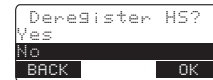

BASICS

Making and Receiving Calls

With the handset's duplex speakerphone, you can have hands-free conversations.

The  icon appears on the display screen during hands-free conversations.



You can easily switch a call from normal conversation to hands-free conversation. To switch a call, press **SPEAKER** during the call.



Note:

- For best performance talk alternately with the caller in a quiet room. You can decrease the speaker volume if you or the other party has difficulty hearing.

BASICS

	From the Handset	
	Normal Conversation	Hands-free Conversation
To answer a call	<p>Handset On the Cradle Pick up the handset (Automatic Talk is: on) or pick up the handset and press TALK/FLASH (Automatic Talk is: off).</p> <p>Handset Off the Cradle Press any number key, * /TONE/ < , or # /> (When Anykey Answer is on), or press TALK/FLASH.</p>	<p>Handset Off the Cradle Press SPEAKER.</p>
To make a call	<p>Handset Off the Cradle 1) Press TALK/FLASH. 2) Listen for the dial tone. 3) Dial the number.</p> <p>OR</p> <p>Dial the number, and then press TALK/FLASH.</p>	<p>Handset Off the Cradle 1) Press SPEAKER. 2) Listen for the dial tone. 3) Dial the number.</p> <p>OR</p> <p>Dial the number, and then press SPEAKER.</p>
To hang up	Press END or return the handset to the cradle.	
To enter a pause within the dialing sequence	When you dial the number in standby mode, press the PAUSE soft key. P appears in the display, which represents a pause.	

Notes:

- To set "Auto Talk", see page E18 or to set "Anykey Answer", see page E18.
- The handset microphone is located at the bottom of the handset (see "Controls and Functions" on page E2). Position yourself as near to the handset as possible and speak clearly.
- If the line is in use by another handset(s), "Line In Use" appears in the display of all registered handsets that are not in use.

BASICS

Call Waiting

If you have Call Waiting service and a call waiting tone sounds while you are on a call, press **TALK/FLASH** on the handset to accept the waiting call. There is a short pause, and then you will hear the new caller. To return to the original caller, press **TALK/FLASH** again.

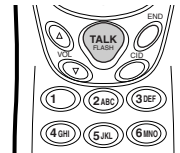

Note:

- You must subscribe through your local telephone company to receive Call Waiting or Caller ID on call waiting service.

Placing a Call on Hold

You can place a call on hold for 5 minutes. When 5 minutes has passed, the call is disconnected, and the phone returns to standby mode.

- During a call, press **INTCM/HOLD**. The call will be put on hold.

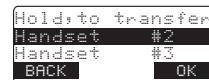

Tip:

- If you leave a call on hold for more than 10 seconds, the display screen will read, Line On Hold.

- To talk to the caller, press **TALK/FLASH** or **SPEAKER** on a handset. The phone will return back to the call.

Note:

- While a call is on hold, CIDCW can not be received.

BASICS

Redialing a Call

The last three phone numbers dialed can be quickly redialed from the handset. Redial numbers stored in the handset are independent from each other.

- 1 With the phone in standby mode, press the **REDIAL** soft key.
- 2 Press **VOL/▲** or **VOL/▼** to scroll through the last three dialed numbers.
- 3 Press **TALK/FLASH** or **SPEAKER** on the handset. The selected number is dialed.
- 4 To hang up, press **END**.



Deleting a Redial Record

- 1 With the phone in standby mode, press the **REDIAL** soft key.
- 2 Press **VOL/▲** or **VOL/▼** repeatedly to display the number to be deleted.
- 3 Press the **DELETE** soft key.
- 4 Press **VOL/▲** or **VOL/▼** to choose **Yes**.
- 5 Press the **OK** soft key. The redialed number is deleted.



Storing a Redial Record

- 1 With the phone in standby mode, press the **REDIAL** soft key.
- 2 Press **VOL/▲** or **VOL/▼** repeatedly to display the number to be stored.
- 3 Press the **STORE** key. **Store/Edit Name** appears.
- 4 To complete the setting, follow the steps 3-8 in "Phonebook (Storing Phone Numbers, Names, Distinctive Rings, and Speed dial)" on page E31.

Notes:

- If the number exceeds 32 digits, only the first 32 digits are retained in redial memory.
- If the redial memory is empty, you will hear a beep.

BASICS

Adjusting the Ringer, and Earpiece and Speaker Volume

Ringer Volume

In standby mode, press the volume up key or volume down key on the handset to select one of three ringer volumes (**Off**, **Low**, or **High**).

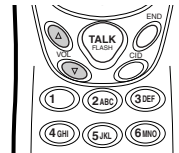

Earpiece and Speaker Volume

You can select from among six volume levels on the handset. Pressing the volume up key or volume down key during a call will change the earpiece or speaker volume. This setting will remain in effect after the telephone call has ended.

If you press the volume up key when the earpiece is at the maximum volume level, an error tone sounds.

The error tone also sounds if you press the volume down key at the lowest volume.

Temporarily Muting the Ringer

You can mute the ringer individually on a handset. When the phone is ringing, pressing the **MUTE** soft key on the handset you want to mute. This mute will last for the current incoming call only. The ringer tone will return to the previous setting on the next incoming call.

Note:

- While charging a handset, you cannot mute the ringer tone for the handset.

Mute Microphone

You can temporarily mute the microphone so that the caller cannot hear you. Press the **MUTE** soft key during talk mode (while the phone is in use) to mute the microphone. Mute On and  appear in the display.

To cancel muting, press the **MUTE** soft key again. Mute Off appears and  disappears from the display.

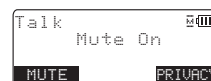

BASICS

Tone Dialing Switch-over

If your telephone company requires pulse dialing, you can switch-over to tone dialing after the call connects. This feature is useful when you need tone dialing to use any automated menu systems, such as telephone bank tellers, telephone prescription refills, customer support menus, etc.

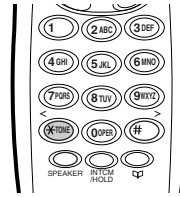

If your phone is set to pulse dialing mode, make your call normally. Once your call connects, press the ***TONE/ <** key. Any digits you enter from then on will be sent as tone digits. When this particular call ends, the phone automatically returns to pulse dialing mode.

Traveling Out of Range

During a call, as you begin to move your handset too far from your base unit, noise may increase. If you pass the range limits of the base unit, you will hear a beep and see **Out of Range** on the display, and then the handset returns to standby mode.

Privacy Mode

Privacy prevents interruption from other registered handsets. **This works only when the phone is in use.**

Press the **PRIVACY** soft key on the handset during talk mode.



Privacy Mode On and  appear in the display. To exit the Privacy Mode, press the **PRIVACY** soft key again when the Privacy Mode is on. Privacy Mode Off appears.

BASICS



Using One Touch Voice Mail Access

If you subscribe to voice mail service, you can use your phone to access your voice mailbox. The new message LED flashes whenever you have messages waiting in your voice mailbox.

Just program the handset with your access number, and you can get your messages at the touch of a button on the handset. (The voice mail service provider will supply you with the access number. This number may be simply a phone number. Refer to the provider's literature.)

To program or delete your Voice Mail Access Number, see page E17.

Dialing your Voice Mail Service

Once you've programmed your personal access number, you can dial your mailbox with the touch of a button. When you have messages, simply press the  soft key. If you have not entered the access number or it has been deleted, when you press the  soft key, No Number Stored To store number press [MENU] appears and you will hear a beep. The phone returns to standby mode.

Resetting the New Message LED

The LED flashes when you have new messages in the voice mail service. If the LED remains on after you've retrieved your messages, you may need to reset the indicators. With the phone in standby mode, press and hold **PAGE** on the base until the paging sound stops (about 5 seconds).

Note:

- You must subscribe to voice mail service from your telephone company in order to use this feature. The voice mail service company will provide you with the access number.

DIRECTORY

Phonebook (Storing Phone Numbers, Names, Distinctive Rings and Speed Dial)

You can store names and numbers in your phone's phonebook, search for names alphabetically, and dial phonebook entries with just a few key presses. You can store up to 100 numbers in each registered handset.

The phone uses the same memory locations to store phonebook entries and Caller ID messages. Empty phonebook locations are used to store Caller ID messages. For example, if you have stored 100 phonebook entries on your handset, the handset will not store Caller ID messages.

- 1 When the phone is in standby mode, press . The following items appear:

(1st line) The number of the phonebook locations used
 (2nd line) How to search (press the number keypad, **VOL/▲** or **VOL/▼**)
 (3rd line) How to store (press the **STORE** soft key)
 (4th line) The **BACK**, **COPY**, and **STORE** soft keys



- 2 Press the **STORE** soft key, Store/Edit Name appears.



- 3 Enter the name (up to 16 characters) by using the number keypad (see the "Steps for Entering Names and Special Characters" on page E33).

If a name is not required, go to step 4. <No Name> will be used as the name.

- 4 Press the **OK** soft key to store the name; Store/Edit No. appears.



- 5 Use the number keypad, ***/TONE/<**, or ***/>** to enter the phone number (up to 20 digits).

If you make an error, use the **DELETE** soft key to erase the incorrect digits. When you are finished, press the **OK** soft key to store the number.

DIRECTORY

- 6** Distinctive Ring appears. Press **VOL/▲** or **VOL/▼** to move the pointer to one of the Distinctive Ring options and then press the **OK** soft key.

```
Distinctive Ring
No Selectn
Flicker
BACK OK
```

- 7** Speed Dial appears. Press **VOL/▲** or **VOL/▼** to move the pointer to select the Speed dial location (10 locations: SPD1-SPD0).

```
Speed Dial
No Selectn
SPD1: <Empty>
BACK OK
```

- 8** Press the **OK** soft key. You will hear a confirmation tone, and Done! appears in the display.

```
Movies
800-730-3456
Beethoven9/SPD1
BACK DELETE EDIT
```

Notes:

- When the memory is full, you will hear a beep and Memory Full appears. You cannot store names and numbers.
- The pause key counts as one digit. Pressing the **PAUSE** soft key more than once increases the length of the pause between numbers. Each pause represents a 2 second delay.
- If you choose not to store a Distinctive Ring, simply select the "No Selectn" option.
- If you choose not to store the name/number as a Speed Dial, simply choose the "No Selectn" option.
- Selecting a speed dial location where a number is already stored releases the old number's speed dial setting. The new number will be stored in the speed dial location.

Chain Dialing

The memory locations in the handset are not limited to phone numbers. You can also store a group of numbers (up to 20 digits) that you need to enter once your call connects. This is referred to as Chain Dialing.

An example of this is a bank account number. Store the account number in one of the phonebook locations (refer to "Phonebook (Storing Phone Numbers, Names, Distinctive Rings and Speed Dial)" on page E31). When you call your bank and are prompted to enter the account number, scroll through your phonebook locations until you find your account number, and then press the **DIAL** soft key.

DIRECTORY

Steps for Entering Names and Special Characters

Refer to the letters on the number keys to select the desired characters. With each press of a number key (0-9), the displayed character appears in the following order: Upper case letters first, lower case letters next and finally the number corresponding to the key.

keys	Number of times key is pressed								
	1	2	3	4	5	6	7	8	9
1	1								
2 abc	A	B	C	a	b	c	2		
3 def	D	E	F	d	e	f	3		
4 ghi	G	H	I	g	h	i	4		
5 jkl	J	K	L	j	k	l	5		
6 mno	M	N	O	m	n	o	6		
7 pqrs	P	Q	R	S	p	q	r	s	7
8 tuv	T	U	V	t	u	v	8		
9 wxyz	W	X	Y	Z	w	x	y	z	9
0 oper	&	<	>	<	>	/	(blank)	-	_
	.	,	:	?	!	@	`	"	*
	#	0							

If you make a mistake while entering a name

Use ***/TONE/<** or ***/>** to move the cursor to the incorrect character. Press the **DELETE** soft key to erase the wrong character, and then enter the correct character. To delete all characters press and hold the **DELETE** soft key.

DIRECTORY

For example, to enter **Movies**:

- 1** When the phone is in standby mode, press  and the **STORE** soft key.
Store/Edit Name appears.
- 2** Press **6** once, and then press **#/>** to move the cursor to the right.
- 3** Press **6** six times.
- 4** Press **8** six times.
- 5** Press **4** six times.
- 6** Press **3** five times.
- 7** Press **7** eight times.
- 8** When finished, press the **OK** soft key.

To continue to store the telephone number, proceed to step 5 in "Phonebook (Storing Phone Numbers, Names, Distinctive Rings, and Speed dial)" on page E31.

Note:

- If the next character uses the same number key, you must press **#/>** to move the cursor over. Otherwise the next time you press the number key, it changes the character that was previously set.

DIRECTORY

Viewing the Phonebook

Your phone stores names/numbers in the phonebook memory locations, and you can search names in alphabetical order. You can view the phonebook even while the phone is in use.

- 1 Press . If you recall the phonebook during a call, the **COPY** and **STORE** soft key will not appear.

```
Phonebook :100
Search [A-Z/↑/↓]
Store [STORE]
BACK COPY STORE
```

- 2 Press **VOL/▲** or **VOL/▼**, or the number keypad to scroll through the phonebook locations. Phonebook locations appear in alphabetical order (from first to last when you press **VOL/▼**, from last to first when you press **VOL/▲**).

You can also use the letters on the number keys to select the first letter of the desired name. Press a number key (**2-9** and **0**) once for the first letter, twice for the second letter, and so on. The first location that begins with the letter you entered appears.

For example, to search for Dentist, press **3** once. Press **VOL/▲** or **VOL/▼**, until the phonebook location is displayed.

- 3 To finish the viewing operation, press **END** (or the **BACK** soft key or **TALK/FLASH** during a call).

Note:

- During a call, don't press **END** on the handset or the call will be disconnected.

DIRECTORY

Making Calls Using the Phonebook

From Standby Mode

- 1 When the phone is in standby mode, select the phonebook location to dial (see "Viewing the Phonebook" on page E35).
- 2 Press **TALK/FLASH** or **SPEAKER** on the handset. The displayed number is dialed.
- 3 To hang up press **END**.



```
Movies
800-730-3456
Beethoven9/SPD1
BACK DELETE EDIT
```

From Talk Mode

- 1 Press **TALK/FLASH** or **SPEAKER**.
- 2 View the phonebook location to dial (see "Viewing the Phonebook" on page E35).
- 3 Press the **DIAL** soft key. The number in the displayed phonebook location is dialed.
- 4 To hang up press **END**.

Speed Dialing

If you store a phone number in a speed dial memory location (10 locations: SPD1 - SPD0), you can use the speed dialing feature. When the phone is in standby mode, press and hold a number key (0-9) associated with the speed dial until the phone number appears, and then press **TALK/FLASH** or **SPEAKER**. The number stored in the speed dial (SPD1 - SPD0) is dialed.

DIRECTORY

Editing or Erasing a Stored Name, Phone Number, Distinctive Ring and Speed Dial

- 1 When the phone is in standby mode, press .
- 2 Press **VOL/▲**, **VOL/▼**, or the number keypad to select the phonebook locations (see "Viewing the Phonebook" on page E35).



Phonebook : 100
 Search [A-Z/↑/↓]
 Store [STORE]
 BACK COPY STORE

a. Editing the Stored Data

- 1 When the phonebook location to be edited appears, press the **EDIT** soft key. Store/Edit Name appears.
 
- 2 Follow the steps 3 to 7 under "Phonebook (Storing Phone Numbers, Names, Distinctive Rings, and Speed Dial)" on page E31 to complete the editing operation.
- 3 Press the **OK** soft key. You will hear a confirmation tone.

b. Deleting the Stored Data

- 1 When the phonebook location to be deleted appears, press the **DELETE** soft key. Delete Memory? appears.
 
- 2 Press **VOL/▲** to move the pointer to Yes.
- 3 Press the **OK** soft key. You hear a confirmation tone. Deleted! appears in the display.

DIRECTORY

Copying Phonebook Locations (CLT-D5882/CLT-D5883)

If you have two handsets, Copy Phonebook allows you to transfer stored phonebook locations from handset to handset so you don't have to manually re-enter names and numbers. You can transfer one memory (phonebook location) at a time, or all memory locations at once.

1 When the phone is in standby mode, press .

2 Press the **COPY** soft key.

3 Press **VOL/▲** or **VOL/▼**, to select the handset you want transfer the phonebook locations and then press the **OK** soft key.



To which unit?
Handset #2
Handset #3
BACK OK

4 Press **VOL/▲** or **VOL/▼** to select One Memory or All Memories: and then press the **OK** soft key.



Copy Phonebook
One Memory
All Memories:xxx
BACK OK

If you select All Memories, Are you sure? appears on the display screen.

Press **VOL/▲** to select Yes, and then press the **OK** soft key.

If you select One Memory, press **VOL/▲** or **VOL/▼**, or the number key (2-9 and 0) to select the phonebook location you want to export and then press the **COPY** soft key.



To select
phonebook
Press [A-Z/↑/↓]
BACK

5 The phonebook locations will be transferred to the handset. Copying and the receiving handset name appear. When the transfer is completed Done! appears on the handset.

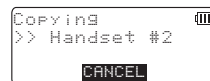

Copying 
>> Handset #2
CANCEL

Notes:

- If the memory location on the receiving handset is full, and cannot store the phonebook locations, you will hear a beep.
- If an error occurs, the phonebook locations transferred before the error were stored in the receiving handset.

CALLER ID FEATURES

Caller ID and CIDCW (Caller ID on Call Waiting)

You must subscribe to Caller ID services through your local telephone provider to use these features.

When the telephone rings, the Caller ID feature allows you to view the caller's name, phone number, date and time of call. With CIDCW (Caller ID on Call Waiting), you will hear a call waiting tone while you are on a call, and the Caller ID data is displayed. To accept the waiting call, press **TALK/FLASH** on the handset. Additionally, you can dial a number stored in the Caller ID list or save data to your Phonebook locations.

Important:

Memory locations for Caller ID messages and Phonebook locations (including Speed Dials) are common; you can store up to 100 locations for each handset. A Caller ID message is not stored when you have stored 100 of the phonebook locations. When you have stored 100 of the phonebook locations and Caller ID messages in total, the earliest Caller ID message is overwritten.

The date and time received	12/21 12:30PM
Caller's name	Jane Smith
Caller's phone number	214-555-1234
	BACK DELETE STORE

- 1 When the Caller ID message is received, the display shows the caller's phone number along with the date and time. The incoming call information is stored in the Caller ID record. If the Caller ID service includes the caller's name, the name will appear in the display (up to 15 characters).

You may receive any one of the following messages:

When invalid data is received;	Incomplete Data
When a private name is received;	Private Name
When a private number is received;	Private Number
When an unknown name is received;	Unknown Name
When an unknown number is received;	Unknown Number

- 2 When you pick up the phone, the display changes to Talk. (Automatic Talk feature is set to on).

CALLER ID FEATURES

Notes:

- If you answer a call before the Caller ID message is received (for example, before the second ring), the Caller ID message will not appear.
- When the call is received via a telephone company that does not offer Caller ID service, the caller's phone number and name does not appear. (This includes some international calls.)
- When the call is via a private branch exchange (PBX), the caller's phone number and name may not appear.
- The number of calls from the same Caller ID appears next to the received time. Once you view the new message, the number will be cleared and disappear.
- Data errors appear as "■."

CALLER ID FEATURES

Viewing the Caller ID List

You can view the Caller ID list through the handset during a call or when the phone is in standby mode.

1 Press **CID**.

The summary screen appears. The screen shows the number of new messages and total messages.

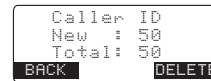

2 To view the Caller ID messages in historical order (from new to old or from old to new), repeatedly press **VOL/▼** to scroll through the messages from the latest to the earliest, or **VOL/▲** to scroll back through the messages.

To view the Caller ID messages with alphabetical search, press the number key pad (**2-9** and **0**) with the letter associated with the first letter of the desired message.

3 To finish the viewing operation, press **END** (or the **BACK** soft key or **TALK/FLASH** during a call).

Notes:

- Once you view the Caller ID list with alphabetical search, you cannot switch back to historical order (from new to old or from old to new) unless you exit and re-enter the operation.
- During a call, do not press **END** on the handset or the call will be disconnected.

CALLER ID FEATURES

Deleting a Caller ID Message

Deleting Information from the Caller ID List

- 1 When the phone is in standby mode, view the Caller ID information to be deleted (see "Viewing the Caller ID List" on page E41).
- 2 Press the **DELETE** soft key. Delete Caller ID appears.
- 3 Press **VOL/▲** or **VOL/▼** to choose Yes.
- 4 Press the **OK** soft key. You will hear a confirmation tone.

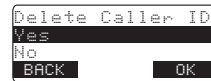

Deleting all Caller ID names/numbers

- 1 When the phone is in standby mode, press **CID**.
Press the **DELETE** soft key. Delete All? appears.
- 2 Press **VOL/▲** to choose Yes.
- 3 Press the **OK** soft key. You will hear a confirmation tone.

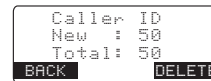

Note:

- Once the Caller ID data has been deleted, the information cannot be retrieved.

CALLER ID FEATURES

Using the Caller ID Message List

Calling a party from the Caller ID list

Standby Mode

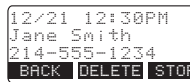
- 1 When the phone is in standby mode, select the Caller ID message (see "Viewing the Caller ID List" on page E41).
- 2 To have the phone dial a "1" before the displayed Caller ID number, press *** /TONE/ <**. To have the phone dial the stored area code before the displayed Caller ID number, press **# / >**.
- 3 Press **TALK/FLASH** or **SPEAKER**. The displayed phone number dials automatically.

Talk Mode

- 1 When the phone is in talk mode, select the Caller ID message you want to dial (see "Viewing the Caller ID List" on page E41).
- 2 Press the **DIAL** soft key, and the number will be dialed.

Storing Caller ID messages in the Phonebook

Messages shown in the Caller ID list can be stored in the phonebook. The phone number and name of the party on the Caller ID list can be stored in memory.

- 1 When the phone is in standby mode, select the Caller ID message to be stored.

Then press the **STORE** soft key. **Store/Edit Name** appears. If the Caller ID message is already stored in memory, you will hear a beep and **This data is already stored!!** appears. The number will not be stored.
- 2 To complete the setting, follow the steps 3-8 in "Phonebook (Storing Phone Numbers, Names, Distinctive Rings, and Speed dial)" on page E31.

CALLER ID FEATURES

Notes:

- When a long distance call has been set, "1" appears in the display.
- If the Caller ID message was received as a private/unknown number, or the message does not have the number, you cannot store the message in the Phonebook. If it was received as private/unknown name, the message will be stored as <No Name>.
- Even if the 100 memory locations are full, the message will be stored in the Phonebook. However, the message will be erased from the Caller ID list.

CALLER ID FEATURES

Call Waiting Deluxe Features

Your phone gives you new options for call waiting. At the touch of a button, you can place the caller on hold, send them to your voice mail service, or conference them into your current call. You must subscribe to Call Waiting and Call Waiting Deluxe to use these features. Not all features are available in all areas. Check with your local telephone company for details.

- 1 When you receive a Call Waiting call, press the **CWDX** soft key for a list of options.
- 2 Press **VOL/▲** or **VOL/▼** or the number keypad (1-7) to select an option.

For example:

press **VOL/▼** 4 times

press **VOL/▼** 2 times

```

1: Ask to Hold
2: Tell Busy
3: Forward Call
BACK      OK
    
```

```

3: Forward Call
4: Answer/Drop 1
5: Conference
BACK      OK
    
```

```

5: Conference
6: Drop First
7: Drop Last
BACK      OK
    
```

- 3 Press the **OK** soft key. A confirmation screen will appear, and the phone returns to the call.

Your phone is pre-programmed with seven call waiting options. You can select to ask the calling party to hold, send them a busy message, forward them to your voice mail, or answer and drop the first caller. You can also select to conference them into the current call or, at any time, choose to drop the first or drop the last caller. Check with your local telephone company for a full list of options.

Notes:

- To activate features and display the **CWDX** soft key, select **CW On/CWDX On** in the **CIDCW** option. See page E21.
- You can also answer a waiting call immediately by pressing **TALK/FLASH**, the first caller will be placed on hold. To return to the original caller, press **TALK/FLASH** again.
- If you don't press a key within 30 seconds while in the operation, the phone returns to the call.
- To return to the call, press the **BACK** soft key.

MULTI-HANDSET FEATURES

The features in this section require a minimum of two handsets to operate.

Using the Walkie-Talkie Mode

To use this feature, you must enter the handsets into Walkie-Talkie mode first. To enter Walkie-Talkie mode, see page E15.

Walkie-Talkie call

- 1** When the phone is in the Walkie-Talkie standby mode, press the *DirectLink* soft key (example of Walkie-Talkie from handset #1).

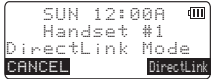

SUN 12:00A
Handset #1
DirectLink Mode
CANCEL DirectLink
- 2** Select the handset to which you wish to Walkie-Talkie with by pressing the number keys (0-9). Your handset will then page the other handset.

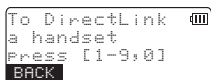

To DirectLink
a handset
Press [1-9,0]
BACK
- 3** On the receiving handset, press **TALK/FLASH**, the **ANSWER** soft key, or if Anykey Answer is on, press any number key, ***/TONE/<**, or **#/>**.



DirectLink
↔ Handset #2
END
- 4** When you finish your conversation, press **END** or the **END** soft key on either handset. Return the handset to the cradle, or press the **CANCEL** soft key and then the **OK** soft key to return to normal standby mode (cancelling Walkie-Talkie mode).

Notes:

- Handsets can be in Walkie-Talkie mode while other handsets are in use.
- While a handset is in a Walkie-talkie mode, it cannot be used to make or receive a call. Other handsets can still make or receive a call.

MULTI-HANDESET FEATURES

3-Way Conferencing

The phone permits 3-way conversations between 2 handsets and an outside line.

- 1** Initiate the call normally. Once the call is in progress, other people can join the call.
- 2** To join a conference call, press **TALK/FLASH** or **SPEAKER** on the other handset.
- 3** To leave a conference call, simply hang up as you normally would. All other parties will remain connected.
- 4** To end a conference call completely, all local parties must hang up. The conference call will also end when the calling party hang up.

Note:

- If the initial handset is in privacy mode, other handsets cannot join the call.

Intercom/Call Transfer Feature

If you have two or more handsets, you can use them as an intercom. Also, you can place an outside call on hold and transfer the call to another handset.

Intercom

- 1** In standby mode, press **INTCM/HOLD**.
- 2** Select the handset you want to talk with within 30 seconds. To select the handset, press **VOL/▲** or **VOL/▼**, and then press the **OK** soft key. If you select All, all other handsets will be paged. An intercom tone sounds. To cancel intercom, press the **CANCEL** soft key on the initiating handset.

To intercom
 Handset #2
 Handset #3
 BACK OK
- 3** To answer the page, press **TALK/FLASH**, **INTCM/HOLD**, or the **ANSWER** soft key. If Anykey Answer is enabled, pressing a number key, ***/TONE/<**, or ***/>** will answer the page. If Automatic Talk is enabled, you can answer the page by simply picking up the handset.

Intercom
 ↔ Handset #1
 ANSWER
- 4** To hang up the intercom call, press **END** or the **END** soft key on either handset.

MULTI-HANDBSET FEATURES

Call Transfer Feature

- 1** During a call, press **INTCM/HOLD** on the handset.
- 2** Select a handset to transfer the call to within 10 seconds.
To select the handset, press **VOL/▲** or **VOL/▼**, and then press the **OK** soft key. If you select **All**, all other handsets will be paged.
The call will automatically be placed on hold, and an intercom tone sounds.
To cancel the transfer, press the **CANCEL** soft key, and then **TALK/FLASH** or **SPEAKER** on the initiating handset.
- 3** To answer the page on a receiving handset, press **TALK/FLASH**, **INTCM/HOLD**, or the **ANSWER** soft key. If Anykey Answer is enabled, pressing a number key, *** /TONE/ <**, or **#/ >** will answer the page. If Automatic Talk is enabled, you can answer the page by simply picking up the handset.
- 4** To speak to the caller, press **TALK/FLASH** on the receiving handset.

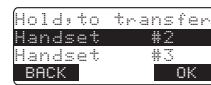

Notes:

- If the party is busy or out of range, the handset returns to standby mode.
- If you receive an outside/intercom call or page while selecting the other handset, the operation will be cancelled.
- If the party does not answer within one minute, the operation is cancelled. Press **TALK/FLASH** or **SPEAKER** to return to the caller.
- During an intercom call, if you receive a call, you will hear a ringer tone from the earpiece. Press **TALK/FLASH** on either handset to answer the call.

ADDITIONAL INFORMATION

Changing the Digital Security Code

The digital security code is an identification code used to connect the handset and the base unit. Normally, setting the code is not necessary. In the rare situation that you suspect another cordless telephone is using the same security code, you can change the code. To change the digital security code:

- 1** In standby mode, select **Deregister HS** in the menu and press the **OK** soft key. **Deregister HS?** appears.
- 2** Press **VOL/▲** to select **Yes** and then the **OK** soft key.

When de-registration is complete you will hear a confirmation tone, and **Deregistration Complete** appears.
- 3** After de-registering the handset, place the handset to the base to register. You must re-register the handset before you can use it.

Find Handset

To locate the handset, press **PAGE** on the base when the phone is in standby mode. All registered handsets beep for 60 seconds, and **Paging** appears on the handset display. To cancel paging, press any key on the handset or **PAGE** on the base.

Note:

- If the battery pack is completely drained, the handset will not beep when paging.

ADDITIONAL INFORMATION

Installing the Beltclip

To attach the beltclip

Insert the beltclip into the holes on each side of the handset. Press down until it clicks.

To remove the beltclip

Pull either side of the beltclip to release the tabs from the holes.

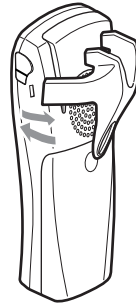

Optional Headset

Your phone can be used with an optional headset. To use this feature, insert the headset plug into the headset jack. Your phone is ready for hands-free conversations.

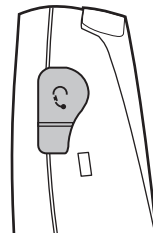

ADDITIONAL INFORMATION

Note on Power Sources

Battery Replacement and Handling

When the operating time becomes short even after a battery is recharged, please replace the battery.

With normal usage, your battery should last about one year.

Warning: To avoid the risk of personal injury or property damage from fire or electrical shock, only use the SANYO battery model and SANYO adapter model specifically designated for this product.

RECYCLING NICKEL-METAL-HYDRIDE BATTERIES



NICKEL-METAL-HYDRIDE BATTERIES MUST BE DISPOSED OF PROPERLY.

Nickel-metal-hydride cells are used in the battery pack. Please take your used nickel-metal-hydride battery packs to a store that recycles nickel-metal-hydride batteries.

Power Failure

During the period that the power is off, you will not be able to make or receive calls with the telephone.

Caution

- Use only the specified SANYO battery pack.
- Do not remove the battery from the handset to charge it.
- Never throw the battery into a fire, disassemble it, or heat it.
- Do not remove or damage the battery casing.

ADDITIONAL INFORMATION

Troubleshooting

If your phone is not performing to your expectations, please try these simple steps first.

Symptom	Suggestion
The CHARGE LED won't illuminate when the handset is placed in the cradle.	<ul style="list-style-type: none"> • Make sure the AC adapter is plugged into the base or the charger (if you have more than one handset) and wall outlet. • Make sure the handset is properly seated in the cradle. • Make sure the charging contacts on the handset are clean.
The audio sounds weak.	<ul style="list-style-type: none"> • Move the handset and/or base away from metal objects or appliances and try again. • Make sure that you are not too far from the base.
Can't make or receive calls.	<ul style="list-style-type: none"> • Check both ends of the base telephone line cord. • Make sure the AC adapter is plugged into the base and wall outlet. • Disconnect the AC adapter for a few minutes, and then reconnect it. • De-register the handset (see "De-register the Handset" on page E23). • Change the digital security code (see "Changing the Digital Security Code" on page E49). • Make sure that you are not too far from the base. • Make sure the line is not in use. • If an outside call is already established, you cannot make another outside call.
The handset doesn't ring or receive a page.	<ul style="list-style-type: none"> • Charge the batteries in the handset for 15-20 hours by placing the handset on the base or charging cradle. • Make sure that you are not too far from the base. • De-register the handset (see "De-register the Handset" on page E23). • Change the digital security code (see "Changing the Digital Security Code" on page E49).
Unavailable appears in the display.	<ul style="list-style-type: none"> • Make sure that another handset(s) is not in use, and try the phone again. • Make sure that you are not too far from the base.

ADDITIONAL INFORMATION

Symptom	Suggestion
Severe noise interference.	<ul style="list-style-type: none"> • Keep the handset away from microwave ovens, computers, remote control toys, wireless microphones, alarm systems, intercoms, room monitors, fluorescent lights, and electrical appliances. • Move to another location or turn off the source of interference.
The Caller ID does not display.	<ul style="list-style-type: none"> • The handset was picked up before the second ring. • The call was placed through a switchboard. • Call your local telephone company to verify your Caller ID service is current. There can be a problem with your Caller ID service.
You cannot register the handset to the base.	<ul style="list-style-type: none"> • Charge the battery pack for 15-20 hours. • De-register the handset (see "De-register the Handset" on page E23). • Change the digital security code (see "Changing the Digital Security Code" on page E49).
The handset doesn't communicate with other handsets.	<ul style="list-style-type: none"> • De-register the handset (see "De-register the Handset" on page E23). • Change the digital security code (see "Changing the Digital Security Code" on page E49). • Make sure that you have registered all handsets.
The handset can't join the conversation.	<ul style="list-style-type: none"> • Make sure there are not 2 handsets already using the 3-way conference feature. • Make sure that another handset is not in privacy mode.
Room Monitor feature does not work.	<ul style="list-style-type: none"> • Make sure to place the handset(s) within the range of the base.

ADDITIONAL INFORMATION

Technical Information

IMPORTANT SAFETY INSTRUCTIONS

When using your telephone equipment, basic safety precautions should always be followed to reduce the risk of fire, electric shock and injury to persons, including the following:

- 1** Do not use this product near water, for example, near a bath tub, wash bowl, kitchen sink or laundry tub, in a wet basement or near a swimming pool.
- 2** Avoid using a telephone (other than a cordless type) during an electrical storm. There may be a remote risk of electric shock from lightning.
- 3** Do not use the telephone to report a gas leak in the vicinity of the leak.
- 4** Use only the power cord and batteries indicated in this manual. Do not dispose of batteries in a fire. They may explode. Check with local codes for possible special disposal instructions.

SAVE THESE INSTRUCTIONS

Caution: Risk of explosion if battery is replaced by an incorrect type. Dispose of used batteries according to the instructions.

I.C. Notice

TERMINAL EQUIPMENT

NOTICE:

This equipment meets the applicable Industry Canada Terminal Equipment Technical Specifications. This is confirmed by the registration number. The abbreviation, IC, before the registration number signifies that registration was performed based on a Declaration of Conformity indicating that Industry Canada technical specifications were met. It does not imply that Industry Canada approved the equipment.

NOTICE:

The Ringer Equivalence Number (REN) for this terminal equipment is marked on the equipment itself. The REN assigned to each terminal equipment provides an indication of the maximum number of terminals allowed to be connected to a telephone interface. The termination on an interface may consist of any combination of devices subject only to the requirement that the sum of the Ringer Equivalence Numbers of all the devices does not exceed five.

RADIO EQUIPMENT

The term "IC:" before the radio certification number only signifies that Industry Canada technical specifications were met.

Operation is subject to the following two conditions: (1) this device may not cause interference, and (2) this device must accept any interference, including interference that may cause undesired operation of the device. "Privacy of communications may not be ensured when using this telephone".

THE SANYO COMFORT WARRANTY

WARRANTY APPLICATION

SANYO Communications products purchased new, unused in Canada through a SANYO Authorized Dealer are warranted against manufacturing defects in materials and workmanship for **ONE YEAR** covering parts and labour, from the date of purchase by the original retail purchaser. This warranty only applies in favour of the original retail purchaser of the warranted product.

SANYO CANADA INC.'S RESPONSIBILITY

During the warranty period, SANYO Canada Inc. will repair, or at our option, replace a Communications product which shows evidence of a manufacturing defect in materials or workmanship. Replacement PARTS are warranted for the remaining portion of the warranty period.

WHAT IS NOT COVERED

- (a) Communications products purchased outside Canada.
- (b) Communications products purchased in a used condition.
- (c) Communications products purchased from non SANYO-authorized dealer.
- (d) Communications products not intended for Canadian usage or products without appropriate Canadian regulatory approvals.
- (e) Problems due to product set-up and installation.
- (f) Adjustments that are outlined in the Operating Manual.
- (g) Accessory items including antenna, and batteries,
- (h) Damage in or due to transportation.
- (i) Damage due to improper maintenance, accident, abuse, misuse or negligence.
- (j) Damage caused by lightning and power surges.

ORIGINAL RETAIL PURCHASER'S RESPONSIBILITY

You, the original retail purchaser, must present your original, dated bill-of-sale together with this warranty to SANYO Canada Inc. or to an authorized SANYO Service Depot when you make a claim under this warranty.

You, the original retail purchaser, are responsible for any costs of TRANSPORTING the product to and from SANYO Canada Inc. or an authorized SANYO Service Depot. You also are responsible for the cost of any

MAINTENANCE necessary in respect of the product.

WARRANTY BECOMES VOID

This warranty becomes void if the product's serial numbers are altered or removed or if any repair to the product is made other than by SANYO Canada Inc. or by an authorized SANYO Service Depot.

LIMITATIONS

- (a) SANYO Canada Inc. reserves the right to change or improve the design of the model of the product warranted hereunder without incurring any obligation to make any modifications to or to install any improvement in or on the product.
- (b) In no event shall SANYO Canada Inc. or any of its Authorized Dealers be liable for special or consequential damage arising from the use of this product.

STATUTORY WARRANTIES

The above provisions do not preclude the operation of any applicable provincial statute which in certain circumstances may not allow some of the limitations and exclusions described in this Warranty. Where any terms of this Warranty are prohibited by such a statute, they shall be deemed null and void but the remainder of this warranty shall remain in effect.

HOW TO OBTAIN WARRANTY SERVICE

Please contact the SANYO Authorized Dealer from whom the product was purchased, or contact us directly at:

SANYO Canada Inc.
1-300 Applewood Cres.
Concord, Ont. L4K 5C7
(905) 760-9944
1-800-263-2244

SOS HELP LINE

At SANYO, fulfilling the needs of our customers is a priority. That's why we created our SOS customer service program that guarantees satisfaction.

NATIONWIDE CUSTOMER SUPPORT

SOS is there to help you. Our friendly and knowledgeable product specialists will quickly answer your questions about setup and use of SANYO telephone products. Simply call toll free from anywhere in Canada to connect to our no-charge, SOS support and service network:

1-800-263-2244

Or visit our website at www.sanyoservice.com, and click the **Customer Relations** button to get access to our FAQ's (Frequently Asked Questions) and other helpful features.

STAY-AT-HOME CONVENIENCE

It's a nuisance making another trip to the store when you're stuck. Now with SOS, all that's necessary is a quick call from your home for product assistance.

HASSLE-FREE EXCHANGE

Should your SANYO telephone require servicing due to a manufacturing defect during the warranty period, SANYO Canada will ship prepaid a replacement unit* within two business days after receiving your defective unit. **Consumers are responsible for the shipping costs of the unit back to SANYO.**

- For older, non-current models, replacement units may not be available, in which case our regular warranty conditions will apply.

GUARANTEED QUALITY

All SOS replacement sets are checked and serviced by factory-authorized technicians before being sent out.

SOS means you never have to worry.

C.O.D. and/or Collect shipments will not be accepted.

Unit must be returned to SANYO in its original box with all accessories, i.e.: owner's manual, battery, adaptor, telephone cord, etc.

Main Menu Flow Chart

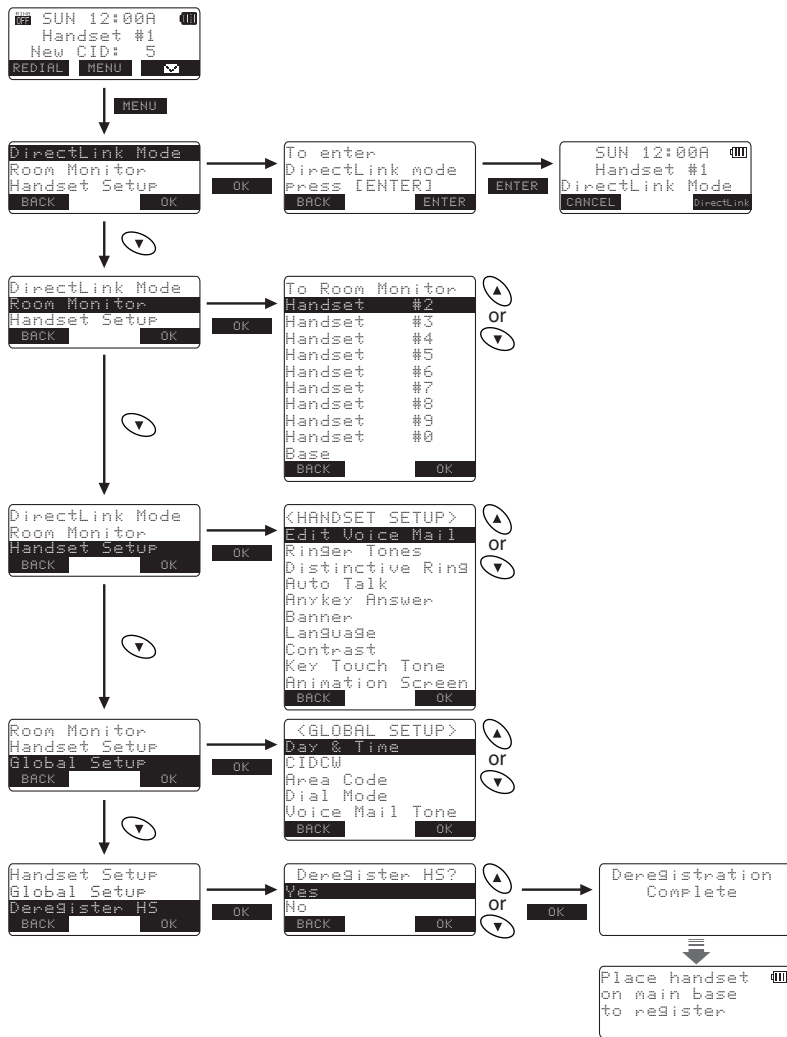

May be covered under one or more of the following U.S. patents:

4,797,916	5,381,460	5,426,690	5,434,905	5,491,745	5,493,605
5,533,010	5,574,727	5,581,598	5,650,790	5,660,269	5,661,780
5,663,981	5,671,248	5,696,471	5,717,312	5,732,355	5,754,407
5,758,289	5,768,345	5,787,356	5,794,152	5,801,466	5,825,161
5,864,619	5,893,034	5,912,968	5,915,227	5,929,598	5,930,720
5,960,358	5,987,330	6,044,281	6,070,082	6,125,277	6,253,088
6,314,278	6,418,209	6,618,015	6,671,315	6,714,630	6,782,098
6,788,920	6,788,953	6,839,550	6,889,184	6,901,271	6,907,094
6,914,940					



SANYO Canada Inc.
Printed in China

UPZZ01800DZ(0)