

DELPHI SERIES



FEATURES

- ◆ High Efficiency: 87.5%@1.5V/15A, 3.3V/15A
- ◆ Standard footprint: 57.9mmx36.8mmx8.5mm (2.28"×1.45"×0.33")
- ◆ Industry standard pin out
- ◆ 2:1 input voltage range
- ◆ Fixed frequency operation
- ◆ Fully protected: OTP, OCP, OVP, UVLO
- ◆ No minimum load required
- ◆ 1500 V isolation and Basic insulation
- ◆ Two independent power train and separate trim for each output
- ◆ ISO 9001, TL 9000, ISO 14001, QS 9000, OHSAS 18001 certified manufacturing facility
- ◆ UL/cUL 60950 (US & Canada) Recognized, and TUV (EN60950) Certified
- ◆ CE mark meets 73/23/EEC and 93/68/EEC directives

Delphi Series Q48DR, 87W-100W, Quarter Brick Dual Output, DC/DC Power Modules: 48V in, 1.5V and 3.3V, 15A out each channel

The Delphi Series Q48DR Quarter Brick Dual, 48V input, dual output, isolated DC/DC converters are the latest offering from a world leader in power system and technology and manufacturing -- Delta Electronics, Inc. This product family provides up to 100 watts of power or 15A of output current (each channel simultaneously) in an industry standard footprint. Both output channels can be used independently of each other with option to trim each channel either in the same direction or in reversion direction. With creative design technology and optimized circuit, these converters possess outstanding electrical and thermal performance, as well as extremely high reliability under highly stressful operating conditions. All the models are fully protected from abnormal input/output voltage, current, and temperature conditions. The Delphi Series converters meet all safety requirements with basic insulation.

OPTIONS

- ◆ Optional second trim pin for independent trim of the two outputs.
- ◆ Positive On/Off logic
- ◆ Short pin lengths available

APPLICATIONS

- ◆ Telecom/DataCom
- ◆ Wireless Networks
- ◆ Optical Network Equipment
- ◆ Server and Data Storage
- ◆ Industrial/Test Equipment

TECHNICAL SPECIFICATIONS (T_A=25°C, airflow rate=300 LFM, V_{in}=48Vdc, nominal V_{out} unless otherwise noted.)

PARAMETER	NOTES and CONDITIONS	Q48DR1R533NRFA				
		Min.	Typ.	Max.	Units	
ABSOLUTE MAXIMUM RATINGS						
Input Voltage						
Continuous				80	Vdc	
Transient (100ms)	<100ms			100	Vdc	
Operating Temperature	Please refer to figure 27 for measuring point	-40		120	°C	
Storage Temperature		-55		125	°C	
Input/Output Isolation Voltage		1500			Vdc	
INPUT CHARACTERISTICS						
Operating Input Voltage		36	48	75	Vdc	
Input Under-Voltage Lockout						
Turn-On Voltage Threshold		33	34	35	Vdc	
Turn-Off Voltage Threshold		31	32	33	Vdc	
Lockout Hysteresis Voltage		1	2	3	Vdc	
Maximum Input Current	100%load, 36Vin			2.7	A	
No-Load Input Current			100	150	mA	
Off Converter Input Current			5	10	mA	
Inrush Current(I ² t)			0.015		A ² s	
Input Reflected-Ripple Current	P-P thru 12µH inductor, 5Hz to 20MHz		10		mA	
Input Voltage Ripple Rejection	120Hz		50		dB	
OUTPUT CHARACTERISTICS						
Output Voltage Set Point	Vin=48V, Io=Io,max, Tc=25°C	Vout 1 Vout 2	1.476 3.247	1.500 3.300	1.524 3.353	Vdc
Output Voltage Regulation						
Over Load	Io1=Io, min to Io, max, Io2=0A Io2=Io, min to Io, max, Io1=0A	Vout 1 Vout 2		±5	±10	mV
Over Line	Vin=36V to 75V, Io1=Io2=full load	Vout 1 Vout 2		±3	±10	V
Cross Regulation	Worse Case			±5	±10	mV
Over Temperature	Tc=-40 °C to 85 °C			±15	±50	
Total Output Voltage Range	Over sample load, line and temperature	Vout 1 Vout 2	1.455 3.201		1.545 3.399	V
Output Voltage Ripple and Noise	5Hz to 20MHz bandwidth					
Peak-to-Peak	Io1, Io2 Full Load, 1µF ceramic, 10µF tantalum	Vout 1 Vout 2		40 40	80 80	mV
RMS	Io1, Io2 Full Load, 1µF ceramic, 10µF tantalum	Vout 1 Vout 2		10 10	30 30	mV
Operating Output Current Range		Vout 1 Vout 2	0 0		15 15	A
Output DC Current-Limit Inception		Vout 1 Vout 2	100% 100%		150% 150%	
DYNAMIC CHARACTERISTICS						
Output Voltage Current Transient	48V, 10µF Tan & 1µF Ceramic load cap, 0.1A/µs					
Positive Step Change in Output Current	Iout1 from 50% Io, max to 75% Io, max	Vout 1 Vout 2		100 100		mV
Negative Step Change in Output Current	Iout2 from 75% Io, max to 50% Io, max	Vout 1 Vout 2		100 100		mV
Cross dynamic	Each channel independence				20	mV
Settling Time (within 1% Vout nominal)				150		US
Turn-On Transient						
Start-up Time, From On/Off Control				10	15	MS
Start-up Time, From Input				10	15	mS
Maximum Output Capacitance	Full load; 5% overshoot of Vout at startup	Vout 1 Vout 2			10000 10000	µF
EFFICIENCY						
100% Load	Iout1, Iout2 full load, 48vdc Vin			87.5		%
60% Load	Iout1, Iout2 60% of full load, 48vdc Vin			88		%
ISOLATION CHARACTERISTICS						
Input to Output			1500			Vdc
Isolation Resistance			10			MQ
Isolation Capacitance				3000		pF
FEATURE CHARACTERISTICS						
Switching Frequency				350		kHz
ON/OFF Control, (Logic Low-Module ON)						
Logic Low	Von/off at Ion/off=1.0mA		0		0.8	V
Logic High	Von/off at Ion/off=0.0 µA				18	V
ON/OFF Current	Ion/off at Von/off=0.0V				1	mA
Leakage Current	Logic High, Von/off=15V				50	µA
Output Voltage Trim Range	Pout ≤ max rated power		-10		+10	%
Output Over-Voltage Protection	Over full temp range; %of nominal Vout		115	122	130	%
GENERAL SPECIFICATIONS						
MTBF	Io=80% of Io, max; Ta=25°C 300LFM			2.5		Mhours
Weight				26.5		grams
Over-Temperature Shutdown	Please refer to figure 27 for measuring point			128		°C



ELECTRICAL CHARACTERISTICS CURVES

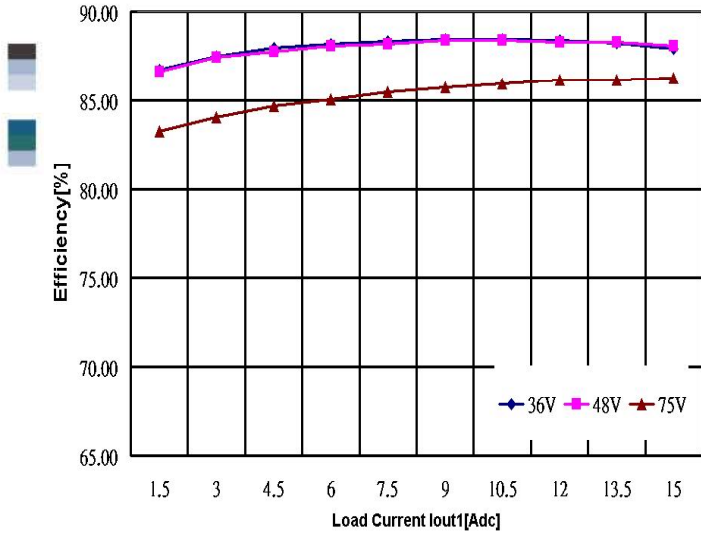

Figure 1: Efficiency vs. load current Iout1 for minimum, nominal, and maximum input voltage at 25°C, for Iout2=7.5A.

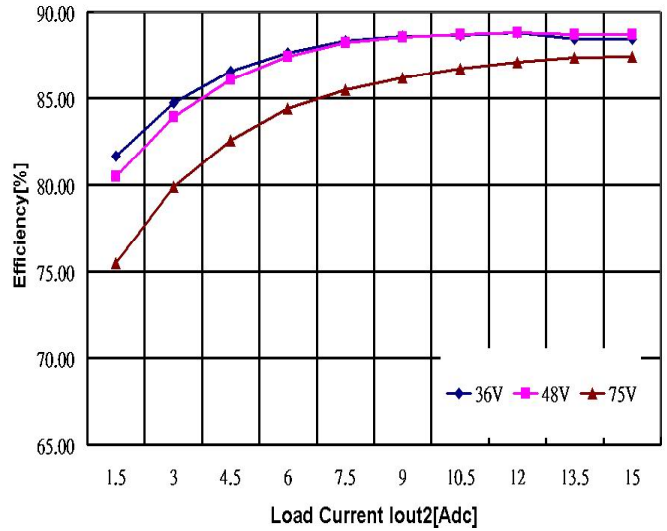

Figure 2: Efficiency vs. load current Iout2 for minimum, nominal, and maximum input voltage at 25°C, for Iout1=7.5A.

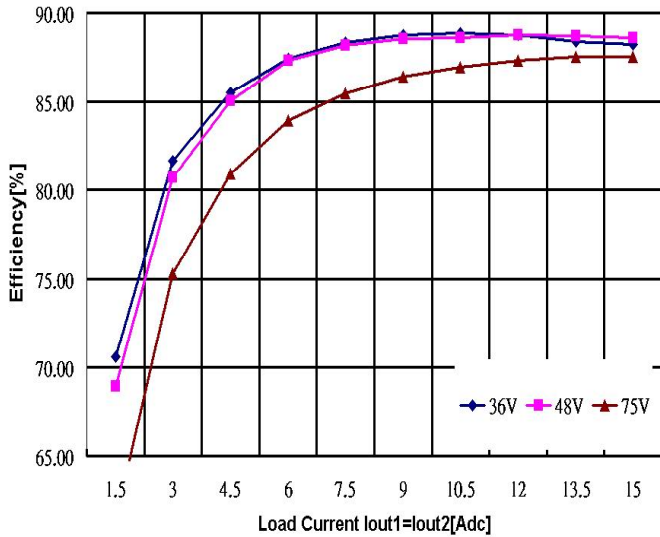

Figure 3: Efficiency vs. load current Iout1 and Iout2 for minimum, nominal, and maximum input voltage at 25°C, for Iout1=Iout2

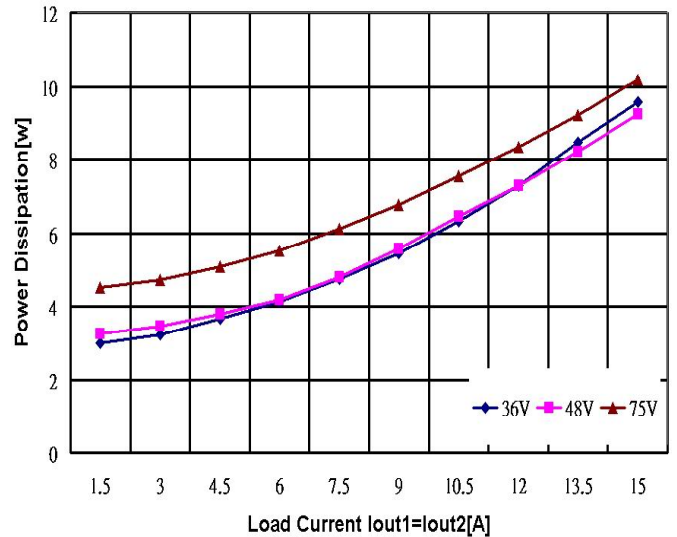

Figure 4: Power dissipation vs. load current for minimum, nominal, and maximum input voltage at 25°C, for Iout1=Iout2



ELECTRICAL CHARACTERISTICS CURVES

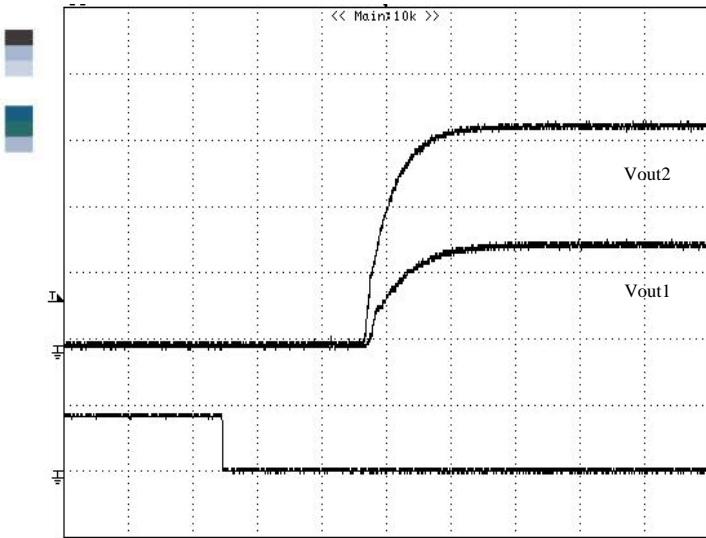

Figure 5: Turn-on transient at zero load current(2ms/div). $V_{in}=48V$. Negative logic turn on. Top Trace: Vout; 1V/div; Bottom Trace: ON/OFF input: 5V/div

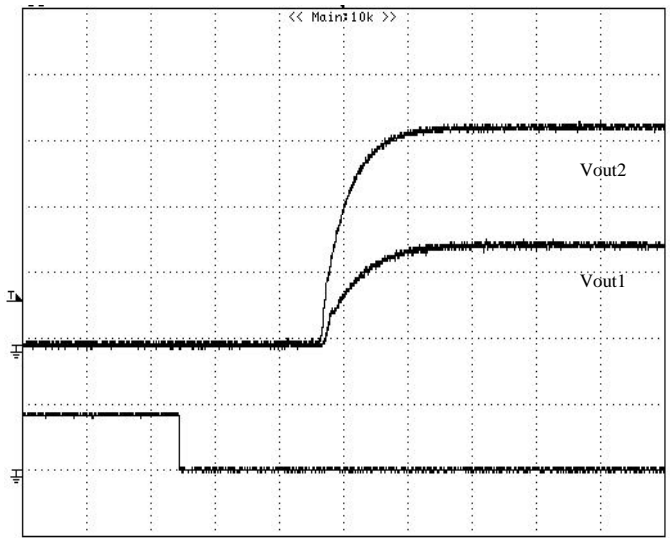

Figure 6: Turn-on transient at full rated load current (resistive load) (2 ms/div). $V_{in}=48V$. Negative logic turn on. Top Trace: Vout; 1V/div; Bottom Trace: ON/OFF input: 5V/div

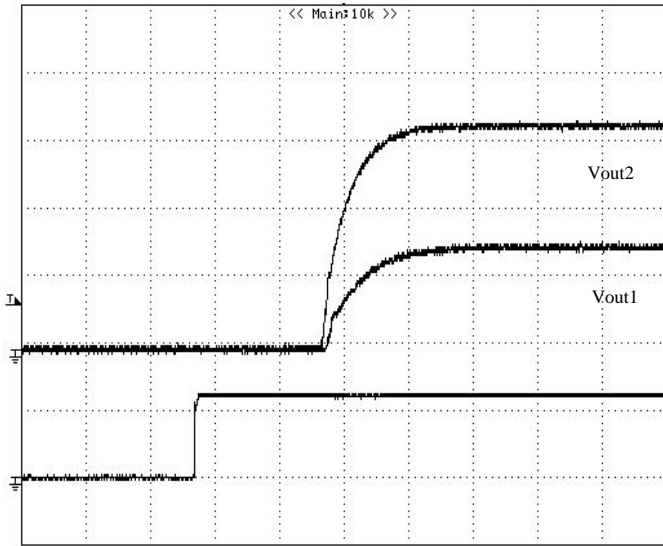

Figure 7: Turn-on transient at zero load current (2ms/div). $V_{in}=48V$. Positive logic turns on. Top Trace: Vout; 1V/div; Bottom Trace: ON/OFF input: 5V/div

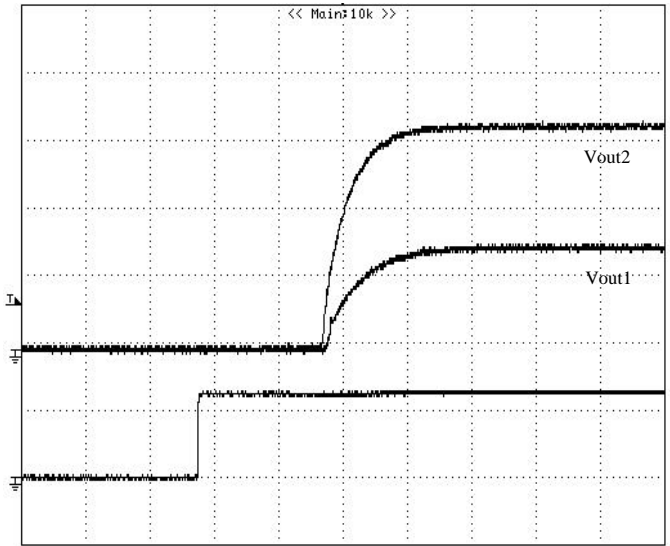

Figure 8: Turn-on transient at full load current (2ms/div). $V_{in}=48V$. Positive logic turns on. Top Trace: Vout; 1V/div; Bottom Trace: ON/OFF input: 5V/div



ELECTRICAL CHARACTERISTICS CURVES

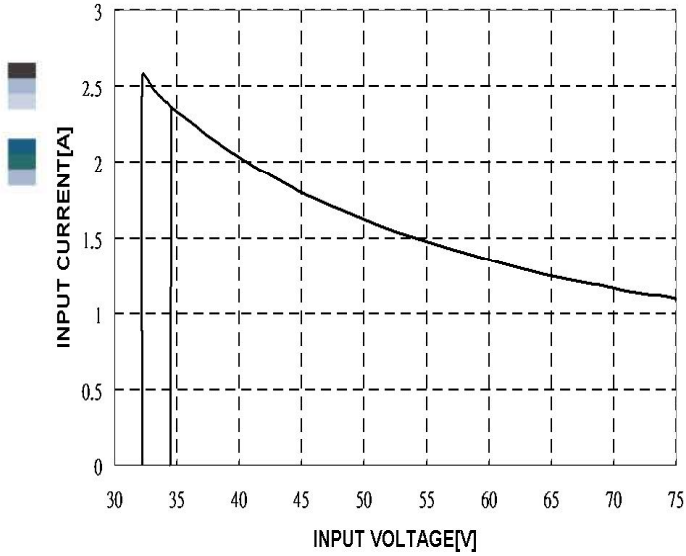

Figure 9: Typical full load input characteristics at room temperature

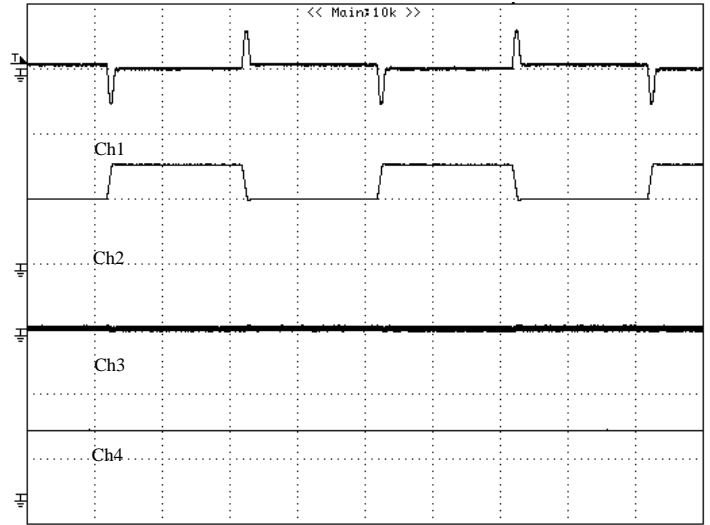

Figure 10: Output voltage response to step-change in load current I_{out2} (75%-50%-75% of I_o , max; $di/dt = 0.1A/\mu s$) at $I_{out1}=7.5A$. Load cap: $10\mu F$, tantalum capacitor and $1\mu F$ ceramic capacitor. Ch1= V_{out2} (100mV/div), Ch2= I_{out2} (7.5A/div), Ch3= V_{out1} (100mV/div), Ch4= I_{out1} (7.5A/div) Scope measurement should be made using a BNC cable (length shorter than 20 inches). Position the load between 51 mm to 76 mm (2 inches to 3 inches) from the module.

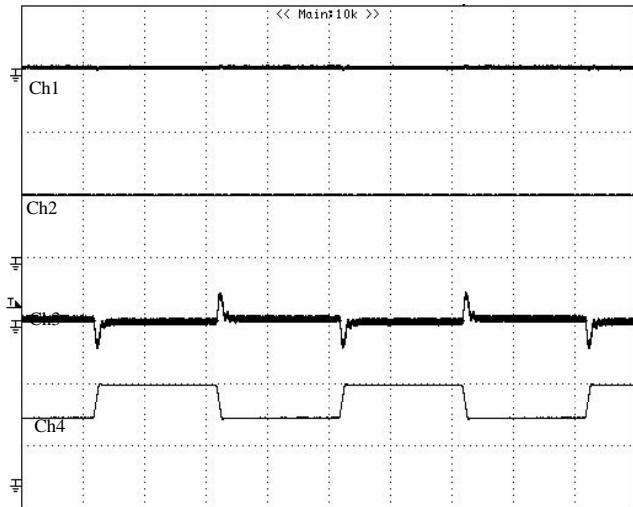

Figure 11: Output voltage response to step-change in load current I_{out1} (75%-50%-75% of I_o , max; $di/dt = 0.1A/\mu s$) at $I_{out2}=7.5A$. Load cap: $10\mu F$, tantalum capacitor and $1\mu F$ ceramic capacitor. Ch1= V_{out2} (100mV/div), Ch2= I_{out2} (7.5A/div), Ch3= V_{out1} (100mV/div), Ch4= I_{out1} (7.5A/div) Scope measurement should be made using a BNC cable (length shorter than 20 inches). Position the load between 51 mm to 76 mm (2 inches to 3 inches) from the module.



Figure 12: Output voltage response to step-change in load current I_{out2} and I_{out1} (75%-50%-75% of I_o , max; $di/dt = 0.1A/\mu s$). Load cap: $10\mu F$, tantalum capacitor and $1\mu F$ ceramic capacitor. Ch1= V_{out2} (100mV/div), Ch2= I_{out2} (7.5A/div), Ch3= V_{out1} (100mV/div), Ch4= I_{out1} (7.5A/div) Scope measurement should be made using a BNC cable (length shorter than 20 inches). Position the load between 51 mm to 76 mm (2 inches to 3 inches) from the module.

ELECTRICAL CHARACTERISTICS CURVES

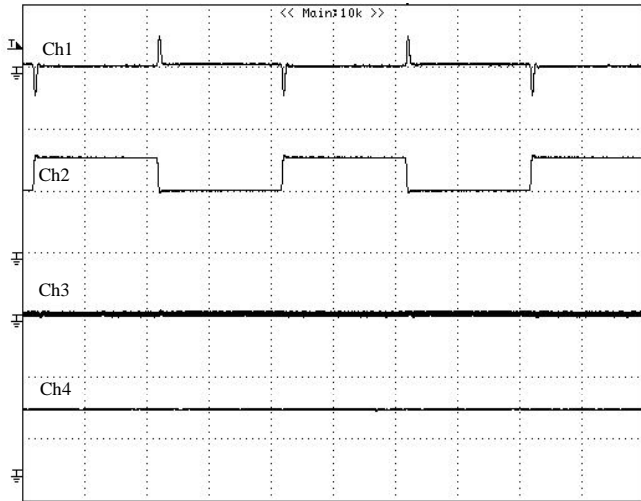

Figure 13: Output voltage response to step-change in load current I_{out2} (75%-50%-75% of $I_{o, max}$; $di/dt = 2.5A/\mu s$) at $I_{out1}=7.5A$. Load cap: $470\mu F$, $35m\Omega$ ESR solid electrolytic capacitor and $1\mu F$ ceramic capacitor. $Ch1=V_{out2}$ (200mV/div), $Ch2=I_{out2}$ (7.5A/div), $Ch3=V_{out1}$ (200mV/div), $Ch4=I_{out1}$ (7.5A/div) Scope measurement should be made using a BNC cable (length shorter than 20 inches). Position the load between 51 mm to 76 mm (2 inches to 3 inches) from the module.

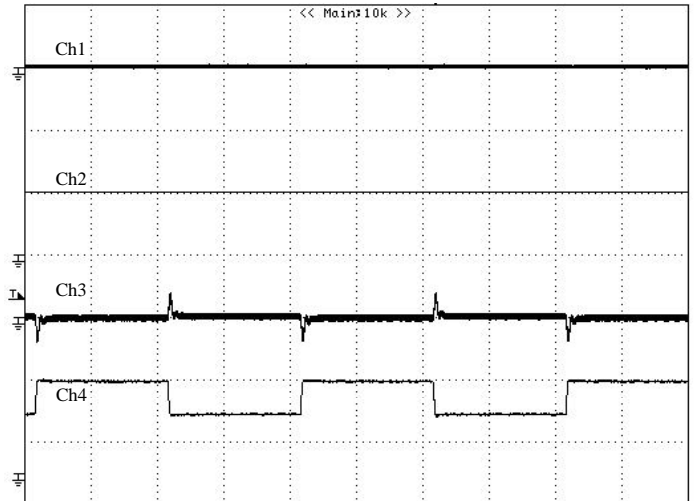

Figure 14: Output voltage response to step-change in load current I_{out1} (75%-50%-75% of $I_{o, max}$; $di/dt = 2.5A/\mu s$) at $I_{out2}=7.5A$. Load cap: $470\mu F$, $35m\Omega$ ESR solid electrolytic capacitor and $1\mu F$ ceramic capacitor. $Ch1=V_{out2}$ (200mV/div), $Ch2=I_{out2}$ (7.5A/div), $Ch3=V_{out1}$ (200mV/div), $Ch4=I_{out1}$ (7.5A/div) Scope measurement should be made using a BNC cable (length shorter than 20 inches). Position the load between 51 mm to 76 mm (2 inches to 3 inches) from the module.

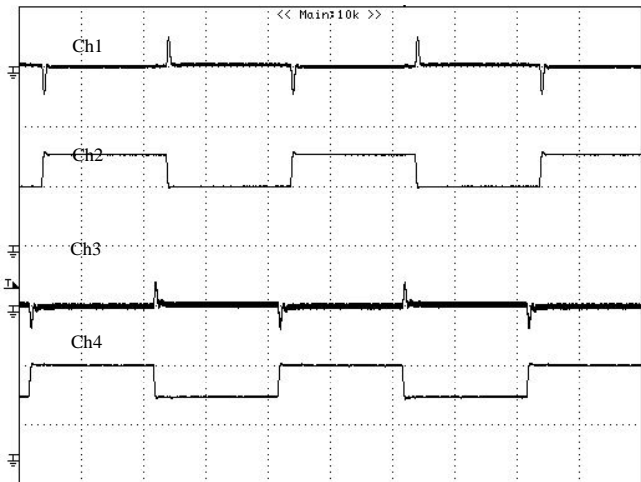

Figure 15: Output voltage response to step-change in load current I_{out2} and I_{out1} (75%-50%-75% of $I_{o, max}$; $di/dt = 2.5A/\mu s$). Load cap: $470\mu F$, $35m\Omega$ ESR solid electrolytic capacitor and $1\mu F$ ceramic capacitor. $Ch1=V_{out2}$ (200mV/div), $Ch2=I_{out2}$ (7.5A/div), $Ch3=V_{out1}$ (200mV/div), $Ch4=I_{out1}$ (7.5A/div) Scope measurement should be made using a BNC cable (length shorter than 20 inches). Position the load between 51 mm to 76 mm (2 inches to 3 inches) from the module.

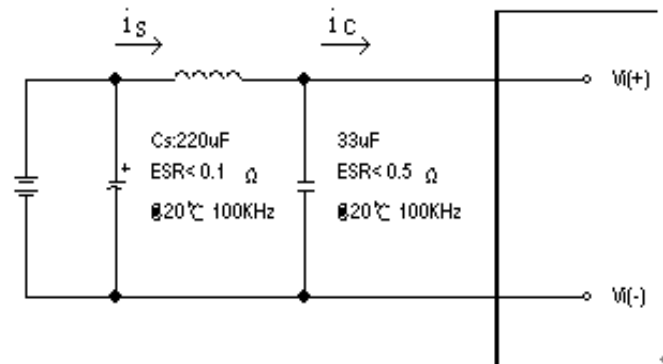

Figure 16: Test set-up diagram showing measurement points for Input Terminal Ripple Current and Input Reflected Ripple Current.

Note: Measured input reflected-ripple current with a simulated source Inductance (L_{TEST}) of $12\mu H$. Capacitor C_s offset possible battery impedance. Measure current as shown above



ELECTRICAL CHARACTERISTICS CURVES

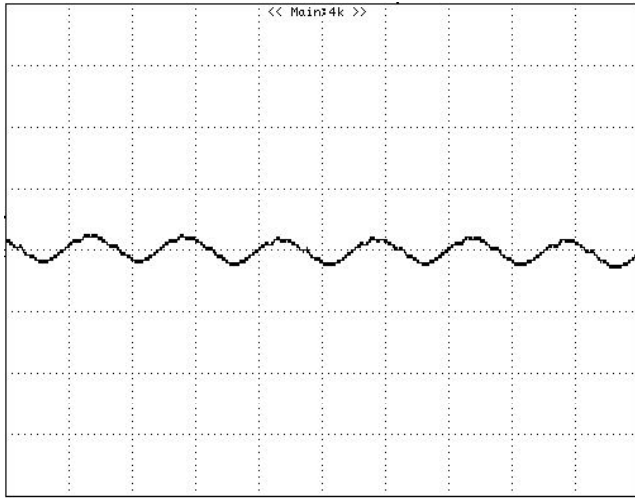

Figure 17: Input Terminal Ripple Current- i_c , at full rated output current and nominal input voltage with $12\mu\text{H}$ source impedance and $33\mu\text{F}$ electrolytic capacitor (500 mA/div, 2us/div).

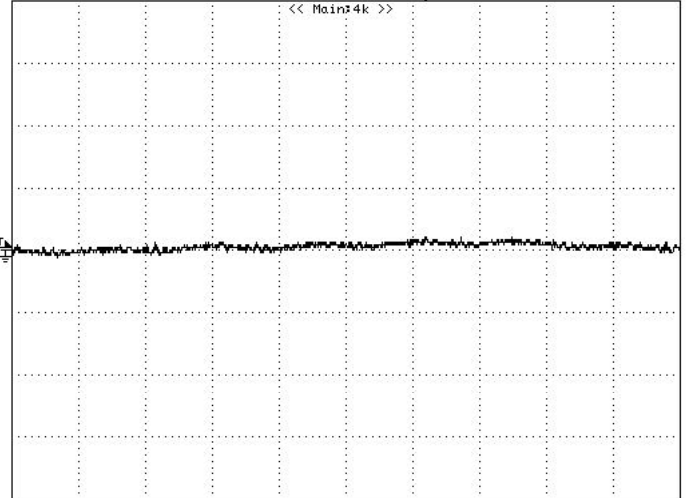

Figure 18: Input reflected ripple current- i_s , through a $12\mu\text{H}$ source inductor at nominal input voltage and rated load current (20 mA/div, 2us/div).

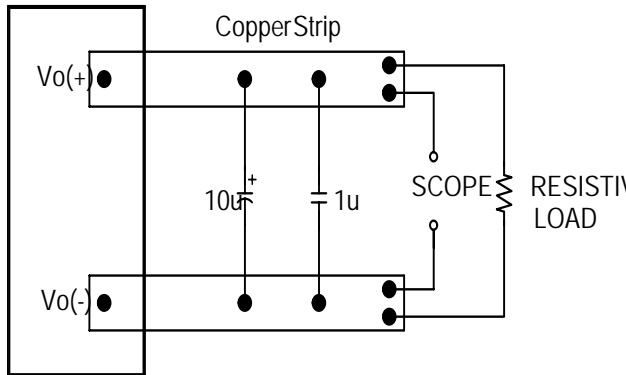

Figure 19: Output voltage noise and ripple measurement test setup

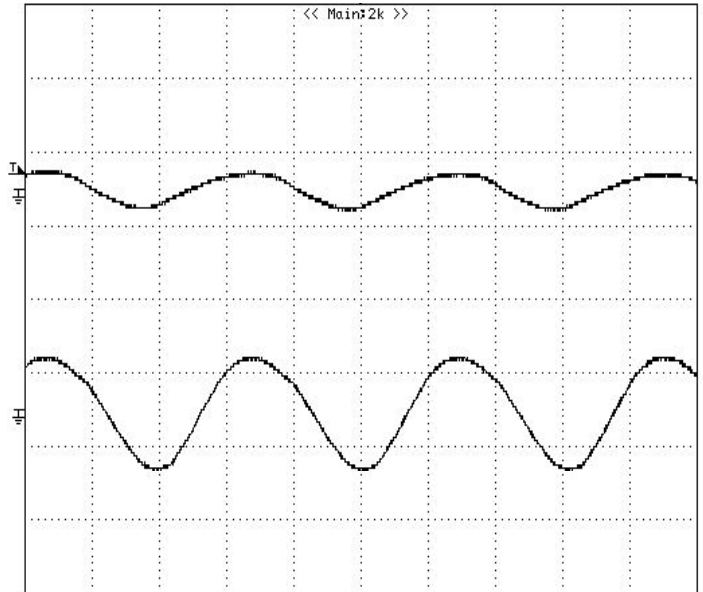

Figure 20: Output voltage ripple at nominal input voltage and rated load current ($I_{out1}=I_{out2}=15\text{A}$)(20 mV/div, 1us/div). Top trace: V_{out2} (20mV/div), Bottom trace(20mV/div) Load capacitance: $1\mu\text{F}$ ceramic capacitor and $10\mu\text{F}$ tantalum capacitor. Bandwidth: 20 MHz. Scope measurements should be made using a BNC cable (length shorter than 20 inches). Position the load between 51 mm to 76 mm (2 inches to 3 inches) from the module.



ELECTRICAL CHARACTERISTICS CURVES

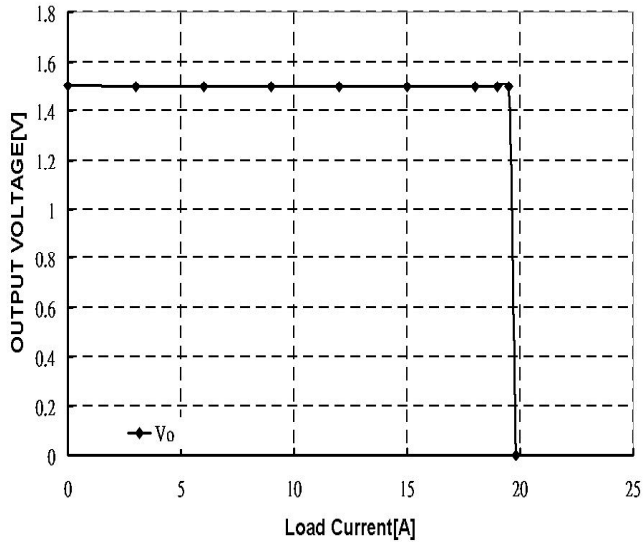

Figure 21: Output voltage vs. load current lout1 showing typical current limit curves and converter shutdown points.

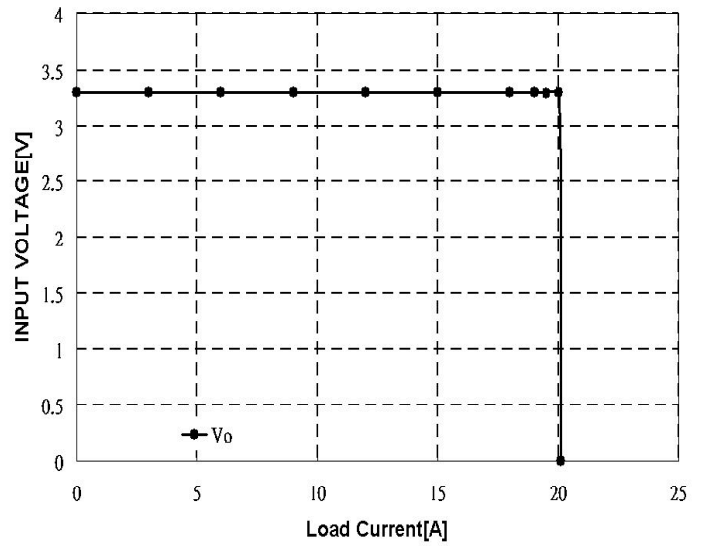

Figure 22: Output voltage vs. load current lout2 showing typical current limit curves and converter shutdown points.

DESIGN CONSIDERATIONS

Input Source Impedance

The impedance of the input source connecting to the DC/DC power modules will interact with the modules and affect the stability. A low ac-impedance input source is recommended. If the source inductance is more than a few μH , we advise adding a 10 to 100 μF electrolytic capacitor ($\text{ESR} < 0.7 \Omega$ at 100 kHz) mounted close to the input of the module to improve the stability.

Layout and EMC Considerations

Delta's DC/DC power modules are designed to operate in a wide variety of systems and applications. For design assistance with EMC compliance and related PWB layout issues, please contact Delta's technical support team. An external input filter module is available for easier EMC compliance design. Application notes to assist designers in addressing these issues are pending release.

Safety Considerations

The power module must be installed in compliance with the spacing and separation requirements of the end-user's safety agency standard, i.e., UL60950, CAN/CSA-C22.2 No. 60950-00 and EN60950: 2000 and IEC60950-1999, if the system in which the power module is to be used must meet safety agency requirements.

When the input source is 60 Vdc or below, the power module meets SELV (safety extra-low voltage) requirements. If the input source is a hazardous voltage which is greater than 60 Vdc and less than or equal to 75 Vdc, for the module's output to meet SELV requirements, all of the following must be met:

- The input source must be insulated from any hazardous voltages, including the ac mains, with reinforced insulation.
- One V_i pin and one V_o pin are grounded, or all the input and output pins are kept floating.
- The input terminals of the module are not operator accessible.
- If the metal baseplate is grounded the output must be also grounded.
- A SELV reliability test is conducted on the system where the module is used to ensure that under a single fault, hazardous voltage does not appear at the module's output.

Do not ground one of the input pins without grounding one of the output pins. This connection may allow a non-SELV voltage to appear between the output pin and ground.

The power module has extra-low voltage (ELV) outputs when all inputs are ELV.

This power module is not internally fused. To achieve optimum safety and system protection, an input line fuse is highly recommended. The safety agencies require a normal-blow fuse with 7A maximum rating to be installed in the ungrounded lead. A lower rated fuse can be used based on the maximum inrush transient energy and maximum input current.

Soldering and Cleaning Considerations

Post solder cleaning is usually the final board assembly process before the board or system undergoes electrical testing. Inadequate cleaning and/or drying may lower the reliability of a power module and severely affect the finished circuit board assembly test. Adequate cleaning and/or drying is especially important for un-encapsulated and/or open frame type power modules. For assistance on appropriate soldering and cleaning procedures, please contact Delta's technical support team.



FEATURES DESCRIPTIONS

Over-Current Protection

The modules include an internal output over-current protection circuit, which will endure current limiting for an unlimited duration during output overload. If the output current exceeds the OCP set point, the modules will automatically shut down (hiccup mode).

The modules will try to restart after shutdown. If the overload condition still exists, the module will shut down again. This restart trial will continue until the overload condition is corrected.

Over-Voltage Protection

The modules include an internal output over-voltage protection circuit, which monitors the voltage on the output terminals. If this voltage exceeds the over-voltage set point, the module will shut down.

The module will try to restart after shutdown. If the over-voltage condition still exists during restart, the module will shut down again. This restart trial will continue until the output voltage is within specification.

Over-Temperature Protection

The over-temperature protection consists of circuitry that provides protection from thermal damage. If the temperature exceeds the over-temperature threshold the module will shut down.

The module will try to restart after shutdown. If the over-temperature condition still exists during restart, the module will shut down again. This restart trial will continue until the temperature is within specification.

Remote On/Off

The remote on/off feature on the module can be either negative or positive logic. Negative logic turns the module on during a logic low and off during a logic high. Positive logic turns the modules on during a logic high and off during a logic low.

Remote on/off can be controlled by an external switch between the on/off terminal and the Vi(-) terminal. The switch can be an open collector or open drain.

For negative logic if the remote on/off feature is not used, please short the on/off pin to Vi(-). For positive logic if the remote on/off feature is not used, please leave the on/off pin to floating.

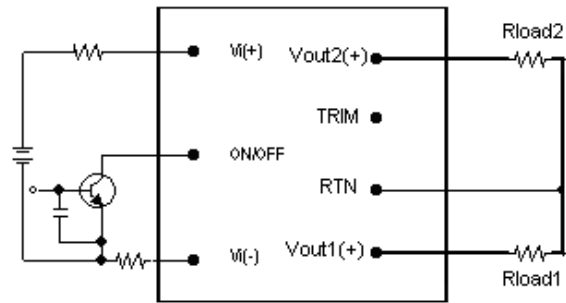

Figure 23: Remote on/off implementation

Output Voltage Adjustment (TRIM)

To increase or decrease the output voltage set point, the modules may be connected with an external resistor between the TRIM pin and either Vout1(+) or RTN. The TRIM pin should be left open if this feature is not used.

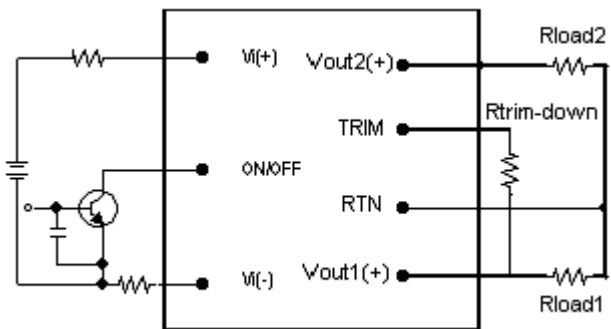

Figure 24: Circuit configuration for trim-down (decrease output voltage)

If the external resistor is connected between the TRIM and Vout1(+) pin, the output voltage set point decreases (Fig. 24). The external resistor value is from the table below.

FEATURES DESCRIPTIONS (CON.)

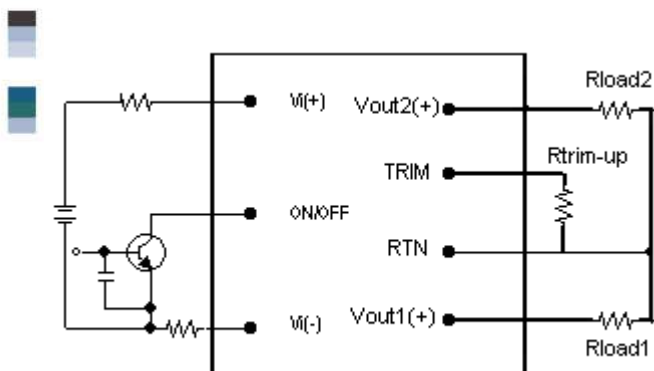

Figure 25: Circuit configuration for trim-up (increase output voltage)

If the external resistor is connected between the TRIM and RTN, the output voltage set point increases (Fig. 25). The external resistor value is from table below.

Trim Resistor (Vout Increase)	
Δ [%]	Rtrim-up [K Ω]
1	57.4
2	25.5
3	14.9
4	9.57
5	6.38
6	4.26
7	2.47
8	1.60
9	709
10	0

Trim Resistor (Vout Decrease)	
Δ [%]	Rtrim-down [K Ω]
1	70.2
2	31.2
3	18.2
4	11.7
5	7.80
6	5.20
7	3.34
8	1.95
9	867
10	0

The output voltage can be increased by the trim pin, When using trim; the output voltage of the module is usually increased, which increases the power output of the module with the same output current. Care should be taken to ensure that the maximum output power of the module remains at or below the maximum rated power.



THERMAL CONSIDERATIONS

Thermal management is an important part of the system design. To ensure proper, reliable operation, sufficient cooling of the power module is needed over the entire temperature range of the module. Convection cooling is usually the dominant mode of heat transfer.

Hence, the choice of equipment to characterize the thermal performance of the power module is a wind tunnel.

Thermal Testing Setup

Delta's DC/DC power modules are characterized in heated vertical wind tunnels that simulate the thermal environments encountered in most electronics equipment. This type of equipment commonly uses vertically mounted circuit cards in cabinet racks in which the power modules are mounted.

The following figure shows the wind tunnel characterization setup. The power module is mounted on a test PWB and is vertically positioned within the wind tunnel. The space between the neighboring PWB and the top of the power module is constantly kept at 6.35mm (0.25").

Thermal Derating

Heat can be removed by increasing airflow over the module. The module's hottest spot is less than + 120°C. To enhance system reliability, the power module should always be operated below the maximum operating temperature. If the temperature exceeds the maximum module temperature, reliability of the unit may be affected.

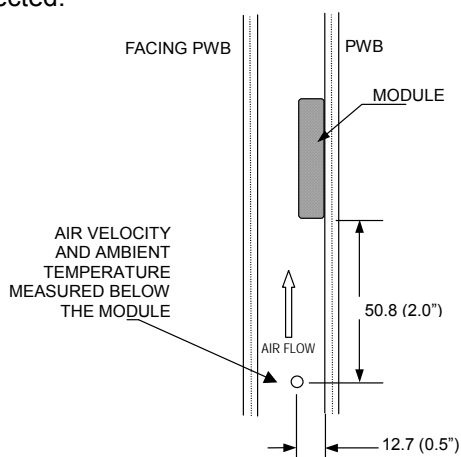

Note: Wind Tunnel Test Setup Figure Dimensions are in millimeters and (Inches)

Figure 26: Wind tunnel test setup

THERMAL CURVES

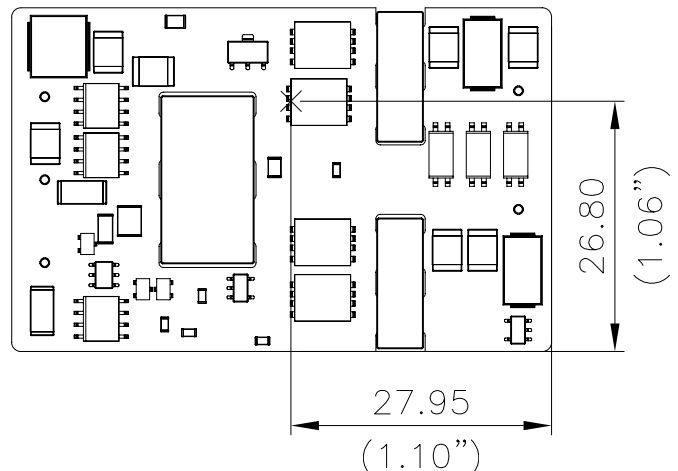

Figure 27: Hot spot temperature measured point
*The allowed maximum hot spot temperature is defined at 120°C

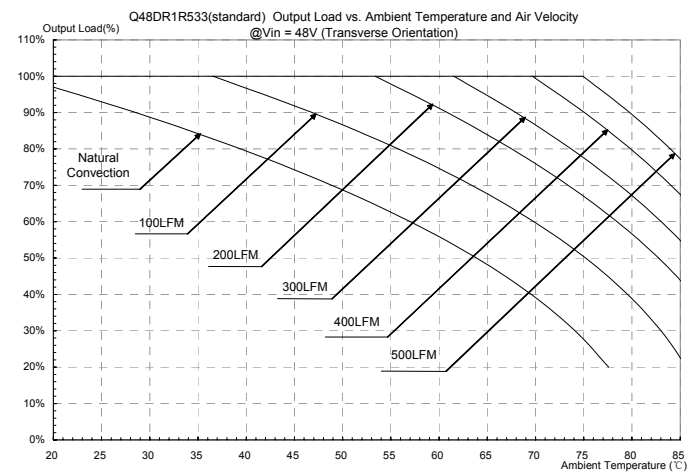
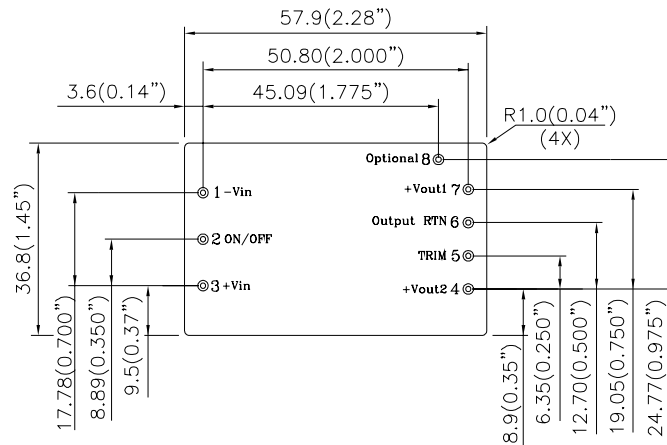
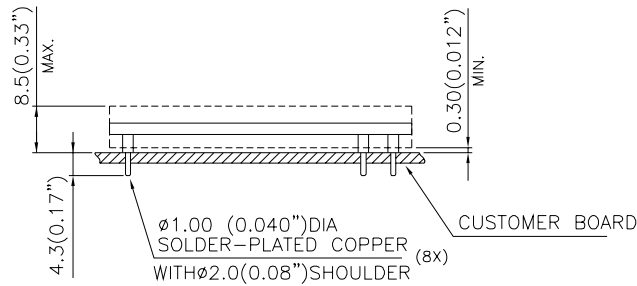

Figure 28: Output load vs. ambient temperature and air velocity
@ $V_{in}=48V$ (Transverse Orientation)

MECHANICAL DRAWING



BOTTOM VIEW



SIDE VIEW

NOTES:
 DIMENSIONS ARE IN MILLIMETERS AND (INCHES)
 TOLERANCES: X.Xmm±0.5mm(X.XX in.±0.02 in.)
 X.XXmm±0.25mm(X.XXX in.±0.010 in.)
 OPTIONAL: Vout2 Trim (Optional: Omit for Single Trim Pin Option)

Pin No.	Name	Function
1	-Vin	Negative input voltage
2	ON/OFF	Remote ON/OFF
3	+Vin	Positive input voltage
4	+Vout2	Positive output voltage2
5	TRIM	Output voltage trim
6	Output RTN	
7	+Vout1	Positive output voltage1
8	Optional	Trim 2

Notes:

- 1 Pins 1-8 are 1.00mm (0.040") diameter
- 2 All pins are copper with Tin plating.

PART NUMBERING SYSTEM

Q	48	D	R	1R5	33	N	R	F	A
Form Factor	Input Voltage	Number of Outputs	Product Series	Output Voltage 1	Output Voltage 2	ON/OFF Logic	Pin Length		Option Code
Q – Quarter Brick	36V~75V	D- Dual Output	R-Open frame	1R5-1.5V 1R8-1.8V 2R5-2.5V 3R3-3.3V	33-3.3V 50-5.0V	N-Negative (Default) P-Positive	R-0.170" (Default) N-0.145" K-0.110"	F- RoHS 6/6 (Lead Free)	A - Standard Functions (Default) B - with second trim pin

MODEL LIST

MODEL NAME	INPUT		OUTPUT		EFF @ Full Load
Q48DR1R533NRFA	36V~75V	2.8A	1.5V/15A	3.3V/15A	87.5%
Q48DR1R833NRFA	36V~75V	2.9A	1.8V/15A	3.3V/15A	88.0%
Q48DR2R533NRFA	36V~75V	3.3A	2.5V/15A	3.3V/15A	88.0%
Q48DR3R350NRFA	36V~75V	3.8A	3.3V/15A	5.0V/10A	88.5%

CONTACT: www.delta.com.tw/dcdc

USA:

Telephone:
East Coast: (888) 335 8201
West Coast: (888) 335 8208
Fax: (978) 656 3964
Email: DCDC@delta-corp.com

Europe:

Phone: +41 31 998 53 11
Fax: +41 31 998 53 53
Email: DCDC@delta-es.com

Asia & the rest of world:

Telephone: +886 3 4526107 ext 6220
Fax: +886 3 4513485
Email: DCDC@delta.com.tw

WARRANTY

Delta offers a two (2) year limited warranty. Complete warranty information is listed on our web site or is available upon request from Delta.

Information furnished by Delta is believed to be accurate and reliable. However, no responsibility is assumed by Delta for its use, nor for any infringements of patents or other rights of third parties, which may result from its use. No license is granted by implication or otherwise under any patent or patent rights of Delta. Delta reserves the right to revise these specifications at any time, without notice.