

DENON

AM-FM STEREO TUNER

TU-1510AE

Owner's Manual

Bedienungsanleitung

Manuel de l'Utilisateur

Manuale delle istruzioni

Manual del usuario

Gebruiksaanwijzing

Bruksanvisning

SAFETY PRECAUTIONS



CAUTION
RISK OF ELECTRIC SHOCK
DO NOT OPEN



CAUTION:
TO REDUCE THE RISK OF ELECTRIC SHOCK, DO NOT REMOVE COVER (OR BACK). NO USER-SERVICEABLE PARTS INSIDE. REFER SERVICING TO QUALIFIED SERVICE PERSONNEL.

The lightning flash with arrowhead symbol, within an equilateral triangle, is intended to alert the user to the presence of uninsulated "dangerous voltage" within the product's enclosure that may be of sufficient magnitude to constitute a risk of electric shock to persons.

The exclamation point within an equilateral triangle is intended to alert the user to the presence of important operating and maintenance (servicing) instructions in the literature accompanying the appliance.

WARNING:
TO REDUCE THE RISK OF FIRE OR ELECTRIC SHOCK, DO NOT EXPOSE THIS APPLIANCE TO RAIN OR MOISTURE.

IMPORTANT SAFETY INSTRUCTIONS

1. Read these instructions.
2. Keep these instructions.
3. Heed all warnings.
4. Follow all instructions.
5. Do not use this apparatus near water.
6. Clean only with dry cloth.
7. Do not block any ventilation openings. Install in accordance with the manufacturer's instructions.
8. Do not install near any heat sources such as radiators, heat registers, stoves, or other apparatus (including amplifiers) that produce heat.
9. Protect the power cord from being walked on or pinched particularly at plugs, convenience receptacles, and the point where they exit from the apparatus.
10. Only use attachments/accessories specified by the manufacturer.
11. Use only with the cart, stand, tripod, bracket, or table specified by the manufacturer, or sold with the apparatus. When a cart is used, use caution when moving the cart/apparatus combination to avoid injury from tip-over.
12. Unplug this apparatus during lightning storms or when unused for long periods of time.
13. Refer all servicing to qualified service personnel. Servicing is required when the apparatus has been damaged in any way, such as power-supply cord or plug is damaged, liquid has been spilled or objects have fallen into the apparatus, the apparatus has been exposed to rain or moisture, does not operate normally, or has been dropped.
14. Batteries shall not be exposed to excessive heat such as sunshine, fire or the like.



CAUTION:

To completely disconnect this product from the mains, disconnect the plug from the wall socket outlet.

The mains plug is used to completely interrupt the power supply to the unit and must be within easy access by the user.

VORSICHT:

Um dieses Gerät vollständig von der Stromversorgung abzutrennen, ziehen Sie bitte den Stecker aus der Wandsteckdose.

Der Netzstecker wird verwendet, um die Stromversorgung zum Gerät völlig zu unterbrechen; er muss für den Benutzer gut und einfach zu erreichen sein.

PRECAUTION:

Pour déconnecter complètement ce produit du courant secteur, débranchez la prise de la prise murale.

La prise secteur est utilisée pour couper complètement l'alimentation de l'appareil et l'utilisateur doit pouvoir y accéder facilement.

ATTENZIONE:

Per scollegare completamente questo prodotto dalla rete di alimentazione elettrica, scollegare la spina dalla relativa presa a muro.

La spina di rete viene utilizzata per interrompere completamente l'alimentazione all'unità e deve essere facilmente accessibile all'utente.

PRECAUCIÓN:

Para desconectar completamente este producto de la alimentación eléctrica, desconecte el enchufe de la pared.

El enchufe de la alimentación eléctrica se utiliza para interrumpir por completo el suministro de alimentación eléctrica a la unidad y debe de encontrarse en un lugar al que el usuario tenga fácil acceso.

WAARSCHUWING:

Om de voeding van dit product volledig te onderbreken moet de stekker uit het stopcontact worden getrokken.

De netstekker wordt gebruikt om de stroomtoevoer naar het toestel volledig te onderbreken en moet voor de gebruiker gemakkelijk bereikbaar zijn.

FÖRSIKTIHETSMÅTT:

Koppla loss stickproppen från eluttaget för att helt skilja produkten från nätet.

Stickproppen används för att helt bryta strömförsörjningen till apparaten, och den måste vara lättillgänglig för användaren.

□ **NOTE ON USE / HINWEIS ZUM GEBRAUCH / OBSERVATIONS RELATIVES A L'UTILISATION / NOTE SULL'USO / NOTAS SOBRE EL USO / ALVORENSTE GEBRUIKEN / OBSERVERA ANGÅENDE ANVÄNDNINGEN**

WARNINGS	WARNHINWEISE	AVERTISSEMENTS	AVVERTENZE	ADVERTENCIAS	WAARSCHUWINGEN	VARNINGAR
<ul style="list-style-type: none"> • Avoid high temperatures. Allow for sufficient heat dispersion when installed in a rack. • Handle the power cord carefully. Hold the plug when unplugging the cord. • Keep the unit free from moisture, water, and dust. • Unplug the power cord when not using the unit for long periods of time. • Do not obstruct the ventilation holes. • Do not let foreign objects into the unit. • Do not let insecticides, benzene, and thinner come in contact with the unit. • Never disassemble or modify the unit in any way. • Ventilation should not be impeded by covering the ventilation openings with items, such as newspapers, tablecloths or curtains. • Naked flame sources such as lighted candles should not be placed on the unit. • Observe and follow local regulations regarding battery disposal. • Do not expose the unit to dripping or splashing fluids. • Do not place objects filled with liquids, such as vases, on the unit. • Do not handle the mains cord with wet hands. • When the switch is in the OFF position, the equipment is not completely switched off from MAINS. • The equipment shall be installed near the power supply so that the power supply is easily accessible. 	<ul style="list-style-type: none"> • Vermeiden Sie hohe Temperaturen. Beachten Sie, dass eine ausreichende Belüftung gewährleistet wird, wenn das Gerät auf ein Regal gestellt wird. • Gehen Sie vorsichtig mit dem Netzkabel um. Halten Sie das Kabel am Stecker, wenn Sie den Stecker herausziehen. • Halten Sie das Gerät von Feuchtigkeit, Wasser und Staub fern. • Wenn das Gerät längere Zeit nicht verwendet werden soll, trennen Sie das Netzkabel vom Netzstecker. • Decken Sie den Lüftungsbereich nicht ab. • Lassen Sie keine fremden Gegenstände in das Gerät kommen. • Lassen Sie das Gerät nicht mit Insektiziden, Benzin oder Verdünnungsmitteln in Berührung kommen. • Versuchen Sie niemals das Gerät auseinander zu nehmen oder zu verändern. • Die Belüftung sollte auf keinen Fall durch das Abdecken der Belüftungsöffnungen durch Gegenstände wie beispielsweise Zeitungen, Tischtücher, Vorhänge o. Ä. behindert werden. • Auf dem Gerät sollten keinerlei direkte Feuerquellen wie beispielsweise angezündete Kerzen aufgestellt werden. • Bitte beachten Sie bei der Entsorgung der Batterien die örtlich geltenden Umweltbestimmungen. • Das Gerät sollte keiner tropfenden oder spritzenden Flüssigkeit ausgesetzt werden. • Auf dem Gerät sollten keine mit Flüssigkeit gefüllten Behälter wie beispielsweise Vasen aufgestellt werden. • Das Netzkabel nicht mit feuchten oder nassen Händen anfassen. • Wenn der Schalter ausgeschaltet ist (OFF-Position), ist das Gerät nicht vollständig vom Stromnetz (MAINS) abgetrennt. • Das Gerät sollte in der Nähe einer Netzsteckdose aufgestellt werden, damit es leicht an das Stromnetz angeschlossen werden kann. 	<ul style="list-style-type: none"> • Eviter des températures élevées. Tenir compte d'une dispersion de chaleur suffisante lors de l'installation sur une étagère. • Manipuler le cordon d'alimentation avec précaution. Tenir la prise lors du débranchement du cordon. • Protéger l'appareil contre l'humidité, l'eau et la poussière. • Débrancher le cordon d'alimentation lorsque l'appareil n'est pas utilisé pendant de longues périodes. • Ne pas obstruer les trous d'aération. • Ne pas laisser des objets étrangers dans l'appareil. • Ne pas mettre en contact des insecticides, du benzène et un diluant avec l'appareil. • Ne jamais démonter ou modifier l'appareil d'une manière ou d'une autre. • Ne pas recouvrir les orifices de ventilation avec des objets tels que des journaux, nappes ou rideaux. Cela entraverait la ventilation. • Ne jamais placer de flamme nue sur l'appareil, notamment des bougies allumées. • Veillez à respecter les lois en vigueur lorsque vous jetez les piles usagées. • L'appareil ne doit pas être exposé à l'eau ou à l'humidité. • Ne pas poser d'objet contenant du liquide, par exemple un vase, sur l'appareil. • Ne pas manipuler le cordon d'alimentation avec les mains mouillées. • Lorsque l'interrupteur est sur la position OFF, l'appareil n'est pas complètement déconnecté du SECTEUR (MAINS). • L'appareil sera installé près de la source d'alimentation, de sorte que cette dernière soit facilement accessible. 	<ul style="list-style-type: none"> • Evitate di esporre l'unità a temperature elevate. Assicuratevi che vi sia un'adeguata dispersione del calore quando installate l'unità in un mobile per componenti audio. • Maneggiate il cavo di alimentazione con attenzione. Tenete ferma la spina quando scollegate il cavo dalla presa. • Tenete l'unità lontana dall'umidità, dall'acqua e dalla polvere. • Scollegate il cavo di alimentazione quando prevedete di non utilizzare l'unità per un lungo periodo di tempo. • Non coprite i fori di ventilazione. • Non inserite corpi estranei all'interno dell'unità. • Assicuratevi che l'unità non entri in contatto con insetticidi, benzolo o solventi. • Non smontate né modificate l'unità in alcun modo. • Le aperture di ventilazione non devono essere ostruite coprendole con oggetti, quali giornali, tovaglie, tende e così via. • Non posizionate sull'unità fi amme libere, come ad esempio candele accese. • Prestate attenzione agli aspetti legati alla tutela dell'ambiente nello smaltimento delle batterie. • L'apparecchiatura non deve essere esposta a goccioli o spruzzi. • Non posizionate sull'unità alcun oggetto contenente liquidi, come ad esempio i vasi. • Non toccare il cavo di alimentazione con le mani bagnate. • Quando l'interruttore è nella posizione OFF, l'apparecchiatura non è completamente scollegata da MAINS. • L'apparecchio va installato in prossimità della fonte di alimentazione, in modo che quest'ultima sia facilmente accessibile. 	<ul style="list-style-type: none"> • Evite altas temperaturas. Permita la suficiente dispersión del calor cuando está instalado en la consola. • Maneje el cordón de energía con cuidado. Sostenga el enchufe cuando desconecte el cordón de energía. • Mantenga el equipo libre de humedad, agua y polvo. • Desconecte el cordón de energía cuando no utilice el equipo por mucho tiempo. • No obstruya los orificios de ventilación. • No deje objetos extraños dentro del equipo. • No permita el contacto de insecticidas, gasolina y diluyentes con el equipo. • Nunca desarme o modifique el equipo de ninguna manera. • La ventilación no debe quedar obstruida por haberse cubierto las aperturas con objetos como periódicos, manteles o cortinas. • No deberán colocarse sobre el aparato fuentes inflamables sin protección, como velas encendidas. • A la hora de deshacerse de las pilas, respete la normativa para el cuidado del medio ambiente. • No exponer el aparato al goteo o salpicaduras cuando se utilice. • No colocar sobre el aparato objetos llenos de líquido, como jarras. • No maneje el cable de alimentación con las manos mojadas. • Cuando el interruptor está en la posición OFF, el equipo no está completamente desconectado de la alimentación MAINS. • El equipo se instalará cerca de la fuente de alimentación de manera que resulte fácil acceder a ella. 	<ul style="list-style-type: none"> • Vermijd hoge temperaturen. Zorg er bij installatie in een audiorack voor, dat de door het toestel geproduceerde warmte goed kan worden afgevoerd. • Hanteer het netsnoer voorzichtig. Houd het snoer bij de stekker vast wanneer deze moet worden aan- of losgekoppeld. • Laat geen vochtigheid, water of stof in het apparaat binnendringen. • Neem altijd het netsnoer uit het stopcontact wanneer het apparaat gedurende een lange periode niet wordt gebruikt. • De ventilatieopeningen mogen niet worden geblokkeerd. • Laat geen vreemde voorwerpen in dit apparaat vallen. • Voorkom dat insecticiden, benzene of verfvendunners met dit toestel in contact komen. • Dit toestel mag niet gedemonteerd of aangepast worden. • De ventilatie mag niet worden belemmerd door de ventilatieopeningen af te dekken met bijvoorbeeld kranten, een tafelkleed of gordijnen. • Plaats geen open vlammen, bijvoorbeeld een brandende kaars, op het apparaat. • Houd u steeds aan de milieuvoorschriften wanneer u gebruikte batterijen wegdoet. • Stel het apparaat niet bloot aan druppels of spatten. • Plaats geen voorwerpen gevuld met water, bijvoorbeeld een vaas, op het apparaat. • Raak het netsnoer niet met natte handen aan. • Als de schakelaar op OFF staat, is het apparaat niet volledig losgekoppeld van de netspanning (MAINS). • De apparatuur wordt in de buurt van het stopcontact geïnstalleerd, zodat dit altijd gemakkelijk toegankelijk is. 	<ul style="list-style-type: none"> • Undvik höga temperaturer. Se till att det finns möjlighet till god värmeavledning vid montering i ett rack. • Hantera nätkabeln varsamt. Håll i kabeln när den kopplas från el-uttaget. • Utsätt inte apparaten för fukt, vatten och damm. • Koppla loss nätkabeln om apparaten inte kommer att användas i lång tid. • Täpp inte till ventilationsöppningarna. • Se till att främmande föremål inte tränger in i apparaten. • Se till att inte insektsmedel på spraybruk, bensen och thinner kommer i kontakt med apparatens hölje. • Ta inte isär apparaten och försök inte bygga om den. • Ventilationen bör inte förhindras genom att täcka för ventilationsöppningarna med föremål såsom tidningar, bordsdukar eller gardiner. • Placera inte öppen eld, t.ex. tända ljus, på apparaten. • Tänk på miljöaspekterna när du bortskaffar batterier. • Apparaten får inte utsättas för vätska. • Placera inte föremål fyllda med vätska, t.ex. vaser, på apparaten. • Hantera inte nätsladden med våta händer. • Även om strömbrytaren står i det avstängda läget OFF, så är utrustningen inte helt bortkopplad från det elektriska nätet (MAINS). • Utrustningen ska vara installerad nära strömuttaget så att strömförsörjningen är lätt att tillgå.

• DECLARATION OF CONFORMITY

We declare under our sole responsibility that this product, to which this declaration relates, is in conformity with the following standards: EN60065, EN55013, EN55020, EN61000-3-2 and EN61000-3-3. Following the provisions of Low Voltage Directive 2006/95/EC and EMC Directive 2004/108/EC, the EC regulation 1275/2008 and its frame work Directive 2009/125/EC for Energy-related Products (ErP).

• ÜBEREINSTIMMUNGSERKLÄRUNG

Wir erklären unter unserer Verantwortung, daß dieses Produkt, auf das sich diese Erklärung bezieht, den folgenden Standards entspricht: EN60065, EN55013, EN55020, EN61000-3-2 und EN61000-3-3. Following the provisions of low voltage directive 2006/95/EC and EMC directive 2004/108/EC, the EC regulation 1275/2008 and its frame work directive 2009/125/EC for energy-related products (ErP).

• DECLARATION DE CONFORMITE

Nous déclarons sous notre seule responsabilité que l'appareil, auquel se réfère cette déclaration, est conforme aux standards suivants: EN60065, EN55013, EN55020, EN61000-3-2 et EN61000-3-3. Selon la directive 2006/95/EC concernant la basse tension et la directive CEM 2004/108/EC, la réglementation européenne 1275/2008 et la directive 2009/125/EC établissant un cadre de travail applicable aux produits liés à l'énergie (ErP).

• DICHIARAZIONE DI CONFORMITÀ

Dichiariamo con piena responsabilità che questo prodotto, al quale la nostra dichiarazione si riferisce, è conforme alle seguenti normative: EN60065, EN55013, EN55020, EN61000-3-2 e EN61000-3-3. Facendo seguito alle disposizioni della direttiva sul basso voltaggio 2006/95/EC alla direttiva EMC 2004/108/EC, alla norma EC 1275/2008 e alla relativa legge quadro 2009/125/EC in materia di prodotti alimentati ad energia (ErP).

QUESTO PRODOTTO E' CONFORME AL D.M. 28/08/95 N. 548

• DECLARACIÓN DE CONFORMIDAD

Declaramos bajo nuestra exclusiva responsabilidad que este producto al que hace referencia esta declaración, está conforme con los siguientes estándares: EN60065, EN55013, EN55020, EN61000-3-2 y EN61000-3-3. De acuerdo con la directiva sobre baja tensión 2006/95/CE y la directiva sobre CEM 2004/108/CE, la normativa CE 1275/2008 y su directiva marco 2009/125/EC para productos relacionados con la energía (ErP).

• EENVORMIGHEIDSVERKLARING

Wij verklaren uitsluitend op onze verantwoordelijkheid dat dit product, waarop deze verklaring betrekking heeft, in overeenstemming is met de volgende normen: EN60065, EN55013, EN55020, EN61000-3-2 en EN61000-3-3. Volgens de voorzieningen van lage spanningsrichtlijn 2006/95/EC en EMC-richtlijn 2004/108/EC, de EU-richtlijn 1275/2008 en de kaderrichtlijn 2009/125/EC voor energieverbruikende producten (ErP).

• ÖVERENSSTÄMMELSESINTYG

Härmed intygats helt på eget ansvar att denna produkt, vilken detta intyg avser, uppfyller följande standarder: EN60065, EN55013, EN55020, EN61000-3-2 och EN61000-3-3. Uppfyller reglerna i lågspanningsdirektivet 2006/95/EC och EMC-direktivet 2004/108/EC, EU-förordningen 1275/2008 och ramverksdirektivet 2009/125/EC för energirelaterade produkter (ErP).

DENON EUROPE
Division of D&M Germany GmbH
An der Kleinbahn 18, Nettetal,
D-41334 Germany

A NOTE ABOUT RECYCLING:

This product's packaging materials are recyclable and can be reused. Please dispose of any materials in accordance with the local recycling regulations.

When discarding the unit, comply with local rules or regulations. Batteries should never be thrown away or incinerated but disposed of in accordance with the local regulations concerning battery disposal.

This product and the supplied accessories, excluding the batteries, constitute the applicable product according to the WEEE directive.

HINWEISE ZUM RECYCLING:

Das Verpackungsmaterial dieses Produktes ist zum Recyceln geeignet und kann wieder verwendet werden. Bitte entsorgen Sie alle Materialien entsprechend der örtlichen Recycling-Vorschriften. Beachten Sie bei der Entsorgung des Gerätes die örtlichen Vorschriften und Bestimmungen.

Die Batterien dürfen nicht in den Hausmüll geworfen oder verbrannt werden; bitte entsorgen Sie die Batterien gemäß der örtlichen Vorschriften.

Dieses Produkt und das im Lieferumfang enthaltene Zubehör (mit Ausnahme der Batterien!) entsprechen der WEEE-Direktive.

REMARQUES CONCERNANT LE RECYCLAGE:

Les matériaux d'emballage de ce produit sont recyclables et peuvent être réutilisés. Veuillez disposer des matériaux conformément aux lois sur le recyclage en vigueur.

Lorsque vous mettez cet appareil au rebut, respectez les lois ou réglementations en vigueur. Les piles ne doivent jamais être jetées ou incinérées, mais mises au rebut conformément aux lois en vigueur sur la mise au rebut des piles.

Ce produit et les accessoires inclus, à l'exception des piles, sont des produits conformes à la directive DEEE.

NOTE RELATIVA AL RICICLAGGIO:

I materiali di imballaggio di questo prodotto sono riutilizzabili e riciclabili. Smaltire i materiali conformemente alle normative locali sul riciclaggio.

Per lo smaltimento dell'unità, osservare le normative o le leggi locali in vigore. Non gettare le batterie, né incenerirle, ma smaltirle conformemente alla normativa locale sui rifiuti chimici.

Questo prodotto e gli accessori inclusi nell'imballaggio sono applicabili alla direttiva RAEE, ad eccezione delle batterie.

NOTAS ACERCA DEL RECICLAJE:

Los materiales de embalaje de este producto son reciclables y se pueden volver a utilizar. Disponga de estos materiales siguiendo los reglamentos de reciclaje de su localidad.

Cuando se deshaga de la unidad, cumpla con las reglas o reglamentos locales. Las pilas nunca deberán tirarse ni incinerarse. Deberá disponer de ellas siguiendo los reglamentos de su localidad relacionados con los desperdicios químicos.

Este producto junto con los accesorios empaquetados es el producto aplicable a la directiva RAEE excepto pilas.

OPMERKINGEN OVER RECYCLING:

Het inpakmateriaal van dit product is recycleerbaar en kan opnieuw gebruikt worden. Er wordt verzocht om zich van elk afvalmateriaal te ontdoen volgens de plaatselijke voorschriften.

Volg voor het wegdoen van de speler de voorschriften voor de verwijdering van wit- en bruingoed op.

Batterijen mogen nooit worden weggegooid of verbrand, maar moeten volgens de plaatselijke voorschriften betreffende chemisch afval worden verwijderd.

Op dit product en de meegeleverde accessoires, m.u.v. de batterijen is de richtlijn voor afgedankte elektrische en elektronische apparaten (WEEE) van toepassing.

OBSERVERA ANGÅENDE ÅTERVINNING:

Produktens emballage är återvinningsbart och kan återanvändas. Kassera det enligt lokala återvinningsbestämmelser.

När du kasserar enheten ska du göra det i överensstämmelse med lokala regler och bestämmelser.

Batterier får absolut inte kastas i soporna eller brännas. Kassera dem enligt lokala bestämmelser för kemiskt avfall.

Denna apparat och de tillbehör som levereras med den uppfyller gällande WEEE-direktiv, med undantag av batterierna.

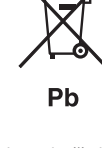

Pb

□ CAUTIONS ON INSTALLATION

**VORSICHTSHINWEISE ZUR AUFSTELLUNG
PRÉCAUTIONS D'INSTALLATION
PRECAUZIONI SULL'INSTALLAZIONE
EMPLAZAMIENTO DE LA INSTALACIÓN
VOORZORGSMAATREGELEN BIJ DE INSTALLATIE
FÖRSIKTIGHET VID INSTALLATIONEN**

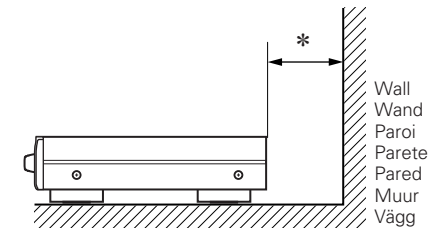
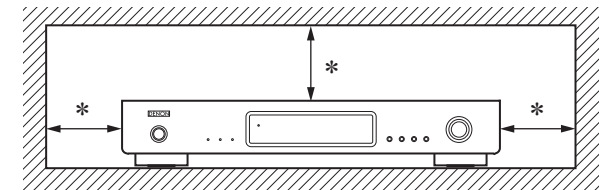

* For proper heat dispersal, do not install this unit in a confined space, such as a bookcase or similar enclosure.

- More than 0.1 m is recommended.
- Do not place any other equipment on this unit.

* Stellen Sie das Gerät nicht an einem geschlossenen Ort, wie in einem Bücherregal oder einer ähnlichen Einrichtung auf, da dies eine ausreichende Belüftung des Geräts behindern könnte.

- Empfohlen wird über 0,1 m.
- Keine anderen Gegenstände auf das Gerät stellen.

* Pour permettre la dissipation de chaleur requise, n'installez pas cette unité dans un espace confiné tel qu'une bibliothèque ou un endroit similaire.

- Une distance de plus de 0,1 m est recommandée.
- Ne placez aucun matériel sur cet appareil.

* Per una dispersione adeguata del calore, non installare questa apparecchiatura in uno spazio ristretto, come ad esempio una libreria o simili.

- Si raccomanda una distanza superiore ai 0,1 m.
- Non posizionare alcun altro oggetto o dispositivo su questo dispositivo.

* Para la dispersión del calor adecuadamente, no instale este equipo en un lugar confinado tal como una librería o unidad similar.

- Se recomienda dejar más de 0,1 m alrededor.
- No coloque ningún otro equipo sobre la unidad.

* Plaats dit toestel niet in een kleine afgesloten ruimte, zoals een boekenkast e.d., omdat anders de warmte niet op gepaste wijze kan worden afgevoerd.

- Meer dan 0,1 m is aanbevolen.
- Plaats geen andere apparatuur op het toestel.

* För att tillförsäkra god värmeavledning får utrustningen inte installeras i instängda utrymmen, som t.ex. en bokhylla eller liknande.

- Mer än 0,1 m rekommenderas.
- Placera ingen annan utrustning ovanpå den här enheten.

Contents

Getting started	1
Accessories	1
Main features	1
Cautions on handling	2
Cautions on installation	2
About the remote control	2
Inserting the batteries	2
Operating range of the remote control	2
Part names and functions	3
Front panel	3
Rear panel	3
Remote control	3
Connections	4
Analog connections	4
Connecting an antenna	4
Connecting the power cord	4
Operations	5
Tuning in radio stations	5
Turning the power on	5
Listening to FM/AM broadcasts	5
Presetting radio stations	6
RDS (Radio Data System)	8
Last function memory	10
Initialization of the microprocessor	10
Troubleshooting	11
Specifications	12
Index	12

Getting started

Thank you for purchasing this DENON product. To ensure proper operation, please read this owner's manual carefully before using the product.

After reading the manual, be sure to keep it for future reference.

Accessories

Check that the following parts are supplied with the product.

- ① Owner's manual 1
- ② Service network list 1
- ③ Power cord (Cord length: Approx. 1.8 m) 1
- ④ Remote control (RC-1144) 1
- ⑤ R03/AAA battery 2
- ⑥ Audio cable (Cord length: Approx. 1.2 m) 1
- ⑦ AM loop antenna 1
- ⑧ FM indoor antenna 1

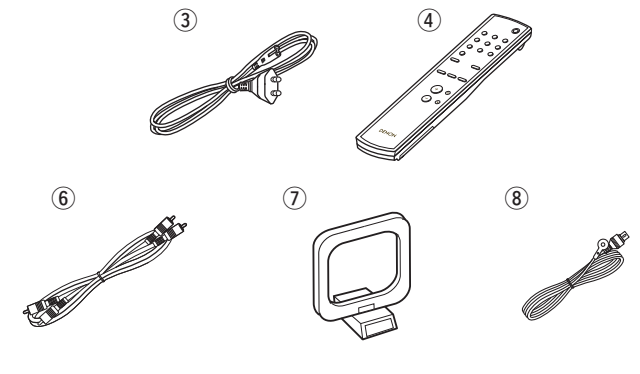

• Note that for explanatory purposes the illustrations in these instructions may differ from the actual unit.

Main features

Large-sized 2-line dot matrix display

FM & AM Tuner with 100 Radio-Stations preset memory capacity

RDS functions

Rotary knob for increased comfortable control

Cautions on handling

• Before turning the power operation switch on

Check once again that all connections are correct and that there are no problems with the connection cables.

- When leaving home for long periods of time, be sure to unplug the power cord from the power outlet.

• About condensation

If there is a major difference in temperature between the inside of the unit and the surroundings, condensation may form on parts inside the unit, causing the unit to fail to operate properly.

If this happens, let the unit sit for an hour or two with the power off and wait until there is little difference in temperature before using the unit.

• Cautions on using mobile phones

Using a mobile phone near this unit may result in noise. If that occurs, move the mobile phone away from the unit when it is in use.

• Moving the unit

Turn off the power and unplug the power cord from the power outlet. Next, disconnect the cables connected to other system units before moving the unit.

• Store these instructions in a safe place

After reading, store these instructions along in a safe place.

Cautions on installation

Noise or disturbance of the picture may be generated if this unit or any other electronic equipment using microprocessors is used near a tuner or TV.

If this happens, take the following steps:

- Install this unit as far away as possible from the tuner or TV.
- Run the antenna wires from the tuner or TV away from this unit's power supply cord and input/output connection cables.
- Noise or disturbance tends to occur particularly when using indoor antennas or 300 Ω feeder wires.

We recommend using outdoor antennas and 75 Ω coaxial cables.

About the remote control

Inserting the batteries

- ① Remove the rear cover of the remote control.
- ② Set two R03/AAA batteries in the battery compartment in the indicated direction.

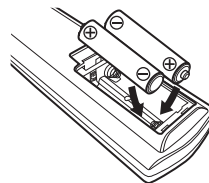
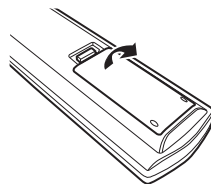

- ③ Put the rear cover back on.

NOTE

- Replace the batteries with new ones if the unit does not operate even when the remote control is operated close to the unit.
- The supplied batteries are only for verifying operation.
- Insert the batteries in the proper direction, following the “⊕” and “⊖” marks in the battery compartment.
- To prevent damage or leakage of battery fluid:
 - Do not use a new battery with an old one.
 - Do not use two different types of batteries.
 - Do not attempt to charge dry batteries.
 - Do not short-circuit, disassemble, heat or dispose of batteries in a fire.
- If the battery fluid leaks, carefully wipe the fluid off the inside of the battery compartment and insert new batteries.
- Remove the batteries from the remote control if it will not be used for a long time.
- Dispose of batteries in accordance with local regulations on battery disposal.

Operating range of the remote control

Operate the remote control while pointing it at the remote sensor.

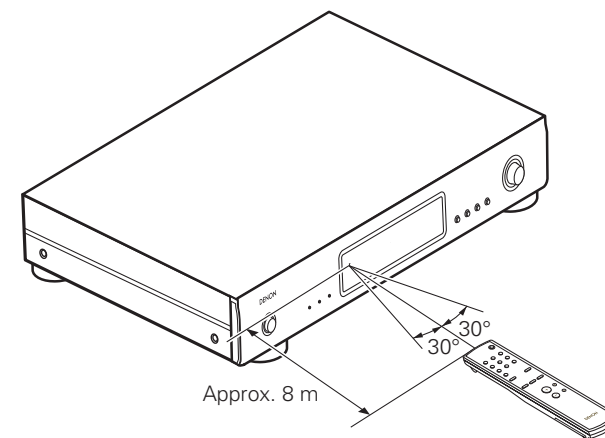

NOTE

The unit may function improperly or the remote control may not operate if the remote control sensor is exposed to direct sunlight or strong artificial light from a fluorescent or infrared light.

Part names and functions

For buttons not explained here, see the page indicated in parentheses ().

Front panel

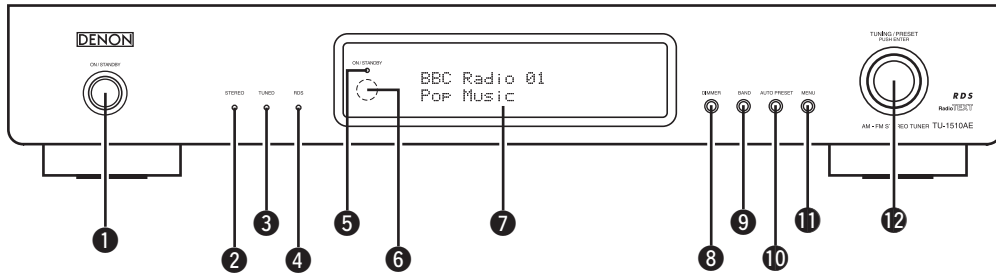

- ① Power operation switch (ON/STANDBY) .. (5)
- ② STEREO indicator (5)
- ③ TUNED indicator (5)
- ④ RDS indicator (8)
- ⑤ ON/STANDBY indicator
This lights when the unit's power is in the "on" or "standby" mode.
- ⑥ Remote control sensor (2)
- ⑦ Display
- ⑧ DIMMER button
The display's brightness can be adjusted in three steps. Press this button to switch the brightness between high, medium and low, in that order.
- ⑨ BAND button (6)
- ⑩ AUTO PRESET button (6)
- ⑪ MENU button (6 – 9)
- ⑫ TUNING/PRESET knob (6 – 9)



The unit is also equipped with a back-up memory. This function provides memory storage when the power switch is off and with the power supply cord disconnected.

Rear panel

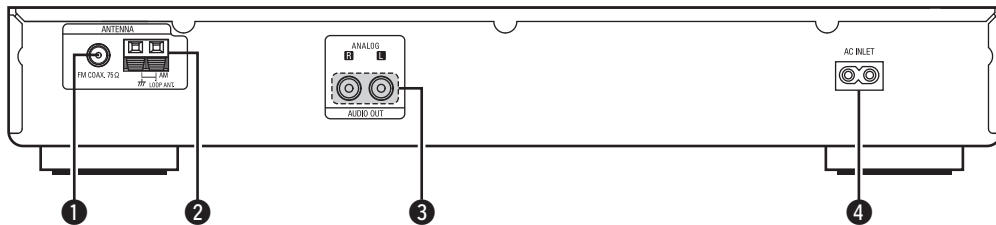

- ① FM antenna terminal (ANTENNA TERMINAL FM) (4)
- ② AM antenna terminals (ANTENNA TERMINAL AM) (4)
- ③ Analog output jacks (4)
- ④ AC Inlet (4)

Remote control

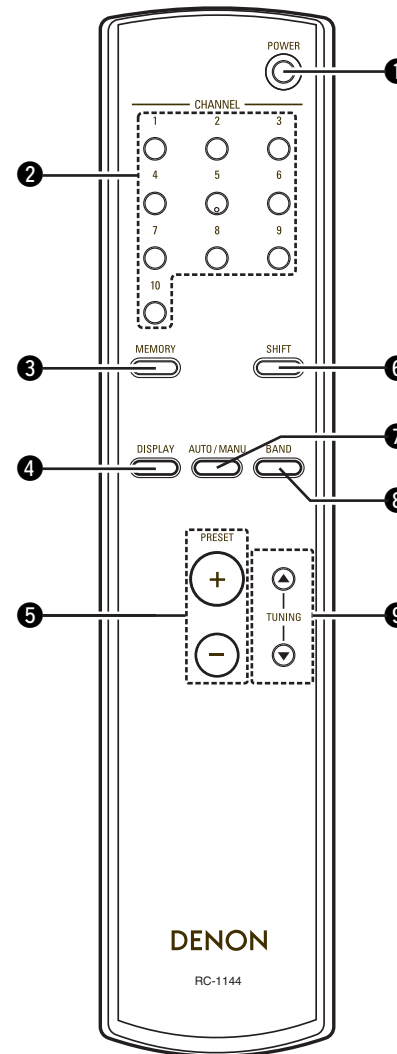

- ① POWER button (5)
- ② CHANNEL buttons (1 – 10) (6, 7)
- ③ MEMORY button (6, 7)
- ④ DISPLAY button (10)
- ⑤ PRESET buttons (6, 7)
- ⑥ SHIFT button (6, 7)
- ⑦ AUTO/MANU button (5)
- ⑧ BAND button (5, 6, 10)
- ⑨ TUNING buttons (5)

Connections

NOTE

- Do not plug in the power cord until all connections have been completed.
- When making connections, also refer to the owner's manual of the other components.
- Be sure to connect the left and right channels properly (left with left, right with right).
- Do not bundle power cords together with connection cables. Doing so can result in humming or noise.
- Do not connect the unit to the PHONO input connectors on the amplifier.

Analog connections

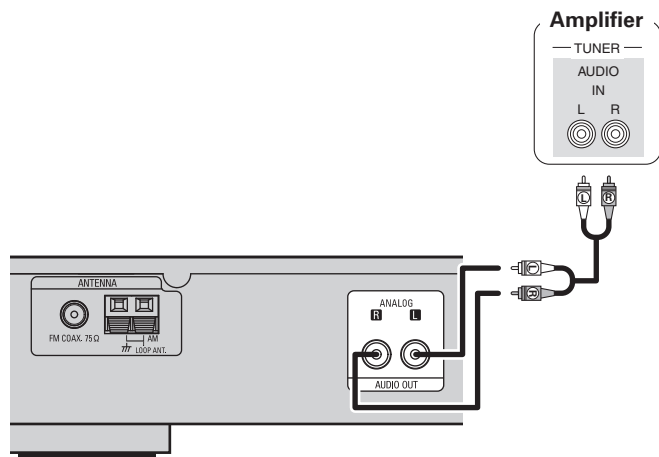
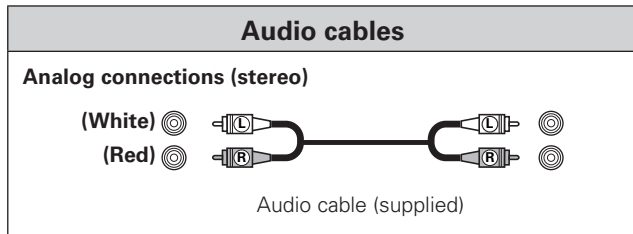

Connecting an antenna

- Connect the FM antenna or AM loop antenna included with the unit to enjoy listening to radio broadcasts.
- After connecting the antenna and receiving a broadcast signal (see page 5 "Listening to FM/AM Broadcasts"), use tape to fix the antenna in a position where noise is the lowest.

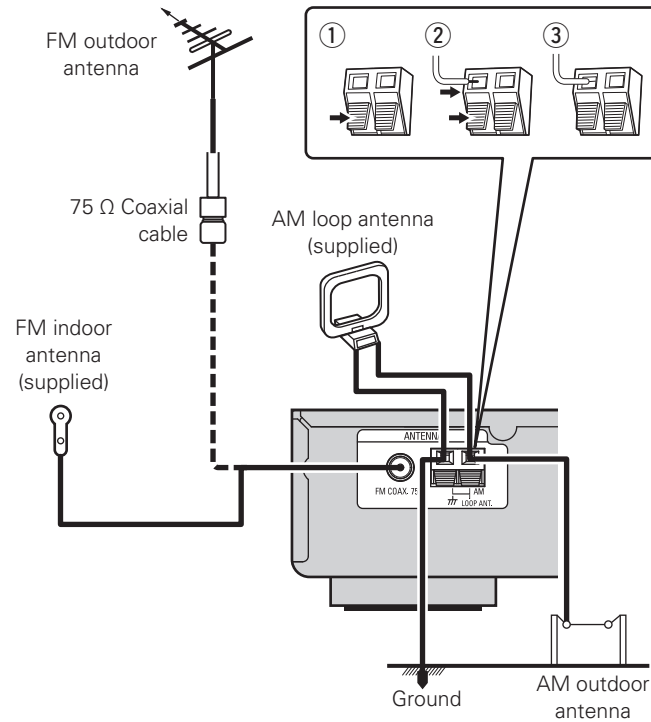

AM loop antenna assembly

1 Put the stand section through the bottom of the loop antenna from the rear and bend it forward.

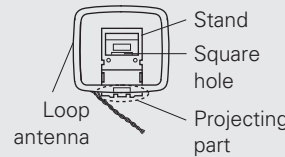

2 Insert the projecting part into the square hole in the stand.

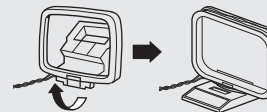

NOTE

- Do not connect two FM antennas simultaneously.
- Even if an external AM antenna is used, do not disconnect the AM loop antenna.
- Make sure the AM loop antenna lead terminals do not touch metal parts of the panel.
- If the signal has noise interference, connect the ground terminal (GND) to reduce noise.
- If you are unable to receive a good broadcast signal, we recommend installing an outdoor antenna. Inquire at the retail store where you purchased the unit for details.

Using the AM loop antenna

To use suspended on a wall

Suspend directly on the wall without assembling.

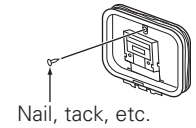

To use standing alone

Use the procedure below to assemble.

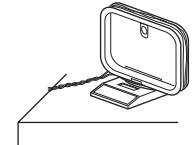

Connecting the power cord

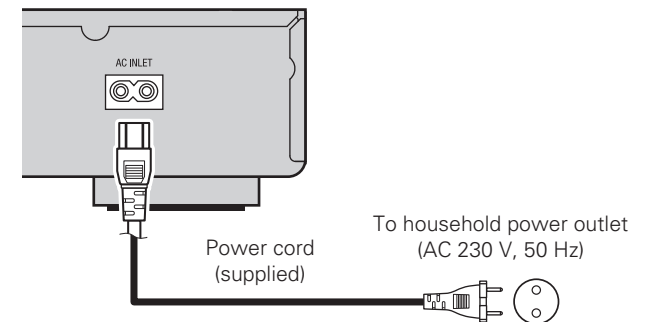

NOTE

- Insert the plugs securely. Loose connections will result in the generation of noise.
- Do not unplug the power cord while the unit is operating.

Operations

Symbols used to indicate buttons in this manual

- Button located on both the main unit and the remote control → **BUTTON**
- Button only on the main → **<BUTTON>**
- Button only on the remote control → **[BUTTON]**

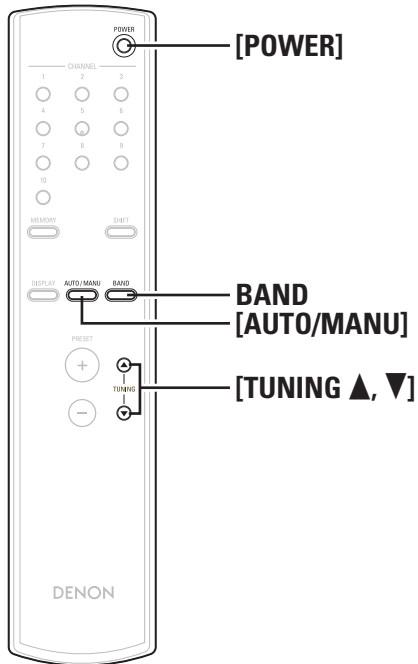
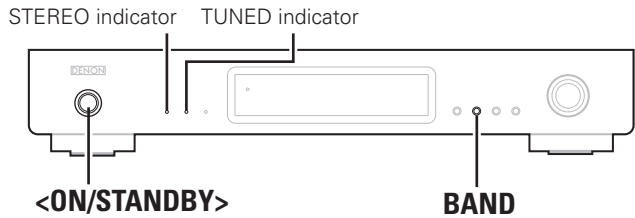

Tuning in radio stations

Turning the power on

❑ Setting the power to the “on” mode

Press **<ON/STANDBY>** or **[POWER]**.

- The display lights and the unit becomes operable.

❑ Setting the power to the “standby” mode

When the power is in the “on” mode, press **<ON/STANDBY>** or **[POWER]**.

- The power is set to the “standby” mode.



The unit is also equipped with a back-up memory. This function provides memory storage when the power switch is off and with the power supply cord disconnected.

NOTE

Power continues to be supplied to some of the circuitry even when the power is in the standby mode. When leaving home for long periods of time or when going on vacation, unplug the power cord from the power outlet.

Listening to FM/AM broadcasts

1 Press **BAND** to select “FM” or “AM”.

- FM** When listening to an FM broadcast.
- AM** When listening to an AM broadcast.

2 Tune in the desired broadcast station.

Auto tuning (FM/AM)

- Press **[AUTO/MANU]** to set “AUTO”.
 - When the auto tuning mode is set, “AUTO” appears to the right of the frequency on the display.



- Press **[TUNING ▲, ▼]**.
 - Auto tuning starts.
 - Press the **[TUNING ▲]** to automatically switch to higher frequencies, the **[TUNING ▼]** to automatically switch to lower frequencies.



- TUNED indicator lights and tuning stops when a frequency whose strength is at or above a specific level is tuned in.
- STEREO indicator lights when a stereo broadcast is received on the FM band.

Manual tuning (FM/AM)

- Press **[AUTO/MANU]** to set the manual tuning mode.
 - When the manual tuning mode is set, the word “AUTO” shown to the right of the frequency on the display turns off.

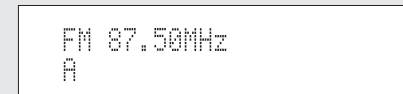

- Press **[TUNING ▲, ▼]**.
 - Press and hold in **[TUNING ▲]** to move to higher frequencies, **[TUNING ▼]** to move to lower frequencies.



- Use the manual tuning mode to tune in stations whose signal is too weak to tune in using the auto tuning mode.
- In the manual tuning mode, the signals are forcibly set to monaural, and STEREO indicator does not light even when receiving stereo broadcasts on the FM band.

Tuning in radio stations

Symbols used to indicate buttons in this manual

- Button located on both the main unit and the remote control → **BUTTON**
- Button only on the main → **<BUTTON>**
- Button only on the remote control → **[BUTTON]**

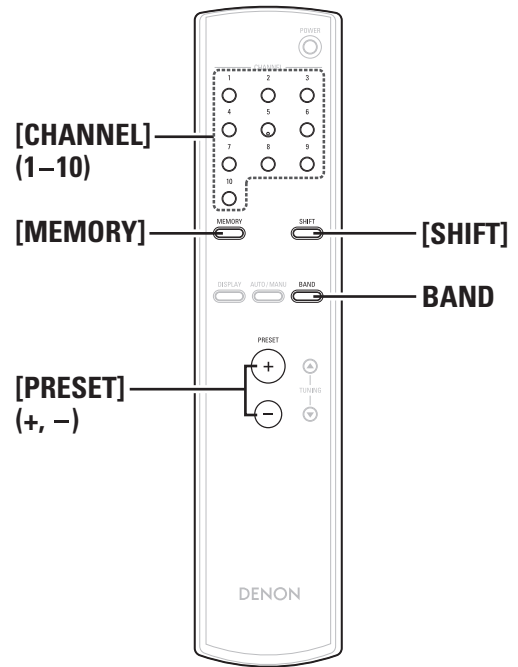
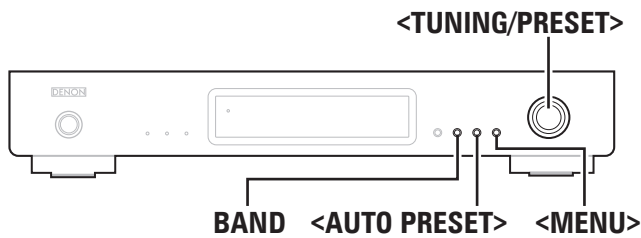

Presetting radio stations

FM auto preset

1 Press **BAND** to select “FM” band.

2 Press **<AUTO PRESET>**.

- The auto preset mode is set and the “AUTO PRESET” indicator on the display flashes.
- FM broadcast stations are automatically searched for and stored in order at the preset channels, starting from “A1”.
- When the first FM broadcast station is found, that station is stored in the preset memory at channel “A1”. Subsequent stations are automatically stored in order at preset channels A1 to A10, B1 to B10, C1 to C10, D1 to D10, E1 to E10, F1 to F10, G1 to G10, H1 to H10, I1 to I10 and J1 to J10 for a maximum of 100 stations.
- Channel “A1” is tuned in after the auto preset memory operation is completed.

If a station’s signal is too weak to tune in using auto preset mode, preset it manually (page 6).

Default value

Auto tuner presets	
A1 – A10	87.5 / 89.1 / 98.1 / 108 / 90.1 / 90.1 / 90.1 / 90.1 / 90.1 / 90.1 MHz
B1 – B10	522 / 603 / 999 / 1404 / 1611 kHz, 90.1 / 90.1 / 90.1 / 90.1 / 90.1 MHz
C1 – C10	90.1 MHz
D1 – D10	90.1 MHz
E1 – E10	90.1 MHz
F1 – F10	90.1 MHz
G1 – G10	90.1 MHz
H1 – H10	90.1 MHz
I1 – I10	90.1 MHz
J1 – J10	90.1 MHz

Manual preset

- Before starting, tune in the station you want to preset.

Operations on the main unit

- 1** Press **<MENU>**.
 - The menu is displayed for 5 seconds.
- 2** While the menu is displayed, turn **<TUNING/PRESET>** to select “Memory”, then press **<TUNING/PRESET>**.
 - The preset mode is set and the preset channel number flashes for about 15 seconds.

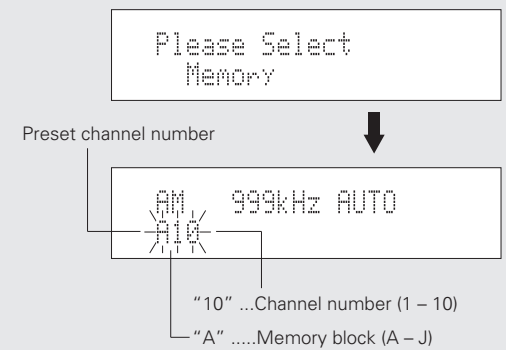

- 3** While the preset channel number is flashing, turn **<TUNING/PRESET>** and select the desired preset channel number.

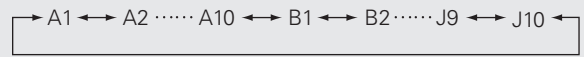

- 4** Press **<TUNING/PRESET>**.
 - The station currently tuned in is stored at the selected preset channel number.
 - To preset other stations, repeat steps 1 to 4.
 - A total of 100 stations, FM and AM included, can be preset.

If a station is preset at a channel number at which a different station is already preset, the previously stored station is cleared and the new station is preset in its place.

Operations on the remote control unit

- 1** Press [MEMORY].
 - The preset mode is set.
- 2** Select the preset channel number.
 - Press [SHIFT] to select the memory block and use [CHANNEL] (1-10) to select the channel number.
 - The preset channel number can also be selected using [PRESET] (+, -).
- 3** Press [MEMORY].
 - The station is preset.

Specify a name for the preset broadcast station

- 1** Select the station whose name you want to set.
 - Example:** To register "DENON" as the FM station name at preset channel "A2".
- 2** Press <MENU>.
- 3** Turn <TUNING/PRESET> to select "Station name".

Please Select
Station Name
- 4** Press <TUNING/PRESET>.
 - The station name input mode is set.

FM 87.50MHz AUTO
A2 _ _ _ _
- 5** Either turn <TUNING/PRESET> or press [PRESET] (+, -) and select "D".
- 6** Press <TUNING/PRESET> to set "D".
 - The cursor "_" starts flashing in the next place.
 - Repeat steps 5 and 6 to input "E", "N", "O" and "N", in that order. (Up to 8 characters can be input.)

FM 87.50MHz AUTO
A2 DENON
- 7** Press <TUNING/PRESET> for at least 2 seconds or press [MEMORY] to make preset channel "A2" flash.
 - When "_" is flashing, preset channel "A2" can also be made to flash by pressing <TUNING/PRESET> for at least 2 seconds or by pressing [MEMORY].
- 8** With channel "A2" flashing, press <TUNING/PRESET> or [MEMORY].
 - The station name you have input is stored in the memory.
 - This procedure can be used to registered station names with up to 8 digits for up to 100 AM/FM stations at random.
 - The 63 characters below can be selected.
 - Overwrite a "_" (Space) to erase an inputted character.

ABCDEFGHIJKLMNOPQRSTUVWXYZO
123456789[\]^_!#" \$ % & ' () * + , - . / : ; < = >
? (space)

Listening to preset stations

Operations on the main unit

- 1** Press <MENU>.
- 2** Turn <TUNING/PRESET> to select "Search Mode", then press the <TUNING/PRESET>.

Please Select
Search Mode
- 3** Turn <TUNING/PRESET> to select "Preset", then press the <TUNING/PRESET>.
 - The preset search mode is set.

Search Mode
Preset
- 4** Turn <TUNING/PRESET> to select the preset channel number.

FM107.95MHz AUTO
A1

Operations on the remote control

- Select the preset channel number.**
- Press [SHIFT] to select the memory block and use [CHANNEL] (1-10) to select the channel number.
 - The preset channel number can also be selected using [PRESET] (+, -).

Tuning in radio stations

Symbols used to indicate buttons in this manual

- Button located on both the main unit and the remote control → **BUTTON**
- Button only on the main → **<BUTTON>**
- Button only on the remote control → **[BUTTON]**



RDS (Radio Data System)

RDS (works only on the FM band) is a broadcasting service which allows a station to send additional information along with the regular radio program signal.

RDS search

Use this function to automatically tune to FM stations that provide the RDS service.

- 1 Press <MENU> to select menu.**
- 2 Turn <TUNING/PRESET> to display “RDS”.**

Please Select
RDS
- 3 Press the <TUNING/PRESET>.**
- 4 Turn <TUNING/PRESET> to display “RDS Search”.**

RDS Search
- 5 Press <TUNING/PRESET> to set the RDS search standby mode.**

<Search Start>
- 6 Turn <TUNING/PRESET> clockwise or counterclockwise just one step.**

RDS Search

 - To automatically begin the RDS search operation.
 - The RDS indicator flashes.
 - If no RDS station are found with the above operation, all the reception bands are searched.
 - When a broadcast station is found, that station’s name appears on the display.

- If no other RDS station is found when all the frequencies are searched, “NO RDS” is displayed.

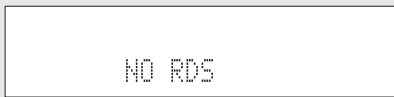

Program type (PTY)

PTY identifies the type of RDS program.

The program types and their displays are as follows:

NEWS	News	WEATHER	Weather
AFFAIRS	Current Affairs	FINANCE	Finance
INFO	Information	CHILDREN	Children’s program
SPORT	Sports	SOCIAL	Social Affairs
EDUCATE	Education	RELIGION	Religion
DRAMA	Drama	PHONE IN	Phone In
CULTURE	Culture	TRAVEL	Travel
SCIENCE	Science	LEISURE	Leisure
VARIED	Varied	JAZZ	Jazz Music
POP M	Pop Music	COUNTRY	Country Music
ROCK M	Rock Music	NATION M	National Music
EASY M	Easy Listening Music	OLDIES	Oldies Music
LIGHT M	Light Classical	FOLK M	Folk Music
CLASSICS	Serious Classical	DOCUMENT	Documentary
OTHER M	Other Music		

PTY search

Use this function to find RDS stations broadcasting a designated program type (PTY).

- 1 Press <MENU> to select menu.**
- 2 Turn <TUNING/PRESET> to display “RDS”.**
- 3 Press <TUNING/PRESET> to set the RDS search selection mode.**

4 Turn <TUNING/PRESET> to display “PTY Search”.

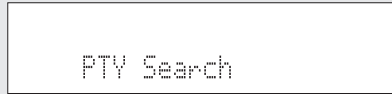

5 Press <TUNING/PRESET> to set the PTY search selection mode.

6 Watching the display, turn <TUNING/PRESET> to call out the desired programme type.

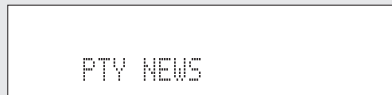

- When receiving an RDS station, its programme type is displayed first.
- When not receiving an RDS station, “PTY” flashes.

7 Press <TUNING/PRESET> to set the PTY search standby mode.

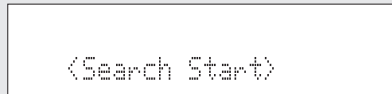

8 Turn <TUNING/PRESET> clockwise or counterclockwise just one step.



- To automatically begin the PTY search operation.
- The RDS indicator flashes.
- If there is no station broadcasting the designated programme type with the above operation, all the reception bands are searched.
- The station name is displayed on the display after searching stops.

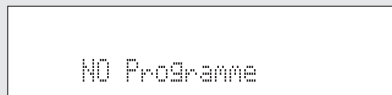

- If no other station broadcasting the designated programme type is found when all the frequencies are searched, “NO Programme” is displayed.

Traffic program (TP)

TP identifies programs that carry traffic announcements. This allows you to easily find out the latest traffic conditions in your area before leaving home.

TP search

Use this function to find RDS stations broadcasting traffic programs (TP stations).

1 Press <MENU> to select menu.

2 Turn <TUNING/PRESET> to display “RDS”.

3 Press <TUNING/PRESET> to set the RDS search selection mode.

4 Turn <TUNING/PRESET> to display “TP Search”.



5 Press <TUNING/PRESET> to set the TP search standby mode.

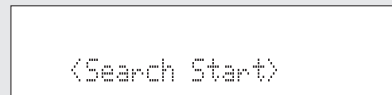

6 Turn <TUNING/PRESET> clockwise or counterclockwise just one step.

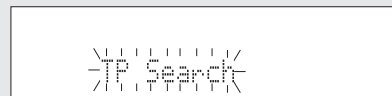

- To automatically begin the TP search operation.
- If no TP station is found with the above operation, all the reception bands are searched.
- The station name is displayed on the display after searching stops.
- If no other TP station is found when all the frequencies are searched, “NO Programme” is displayed.



Radio text (RT)

RT allows RDS stations to send text messages that appear on the display. “RT” appears on the display when radio text data is received.

1 Press <MENU> to select menu.

2 Turn <TUNING/PRESET> to display “RDS”.

3 Press <TUNING/PRESET> to set the RDS search selection mode.

4 Turn <TUNING/PRESET> to display “RT ON/OFF”.



5 Press <TUNING/PRESET> to set the RT ON/OFF selection mode.

6 Turn <TUNING/PRESET> to choose the “RT ON” or “RT OFF”.



7 Press <TUNING/PRESET> to set whether to enable or stop the RADIO TEXT function.

- If no text data is being broadcasted, “NO TEXT DATA” is displayed.

Tuning in radio stations

Symbols used to indicate buttons in this manual

- Button located on both the main unit and the remote control → **BUTTON**
- Button only on the main → **<BUTTON>**
- Button only on the remote control → **[BUTTON]**

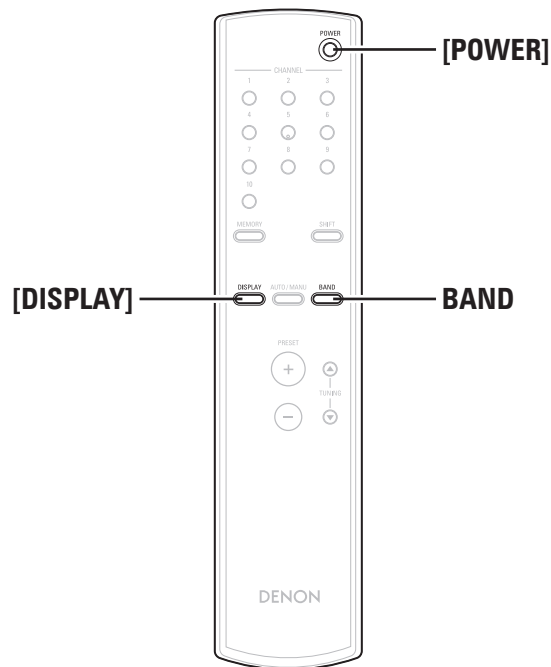
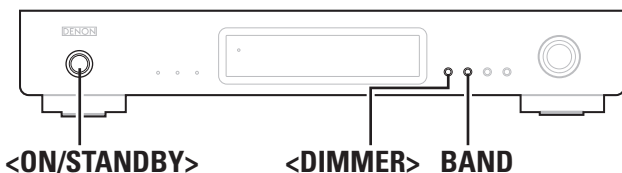

Switching RDS information display

1 Use the procedure described at “Auto tuning”, “Listening to preset stations” or “RDS search” to tune in a frequency with an RDS station.

2 Press **[DISPLAY]** to switch the RDS reception information.

- The display switches as shown below each time **[DISPLAY]** is pressed.

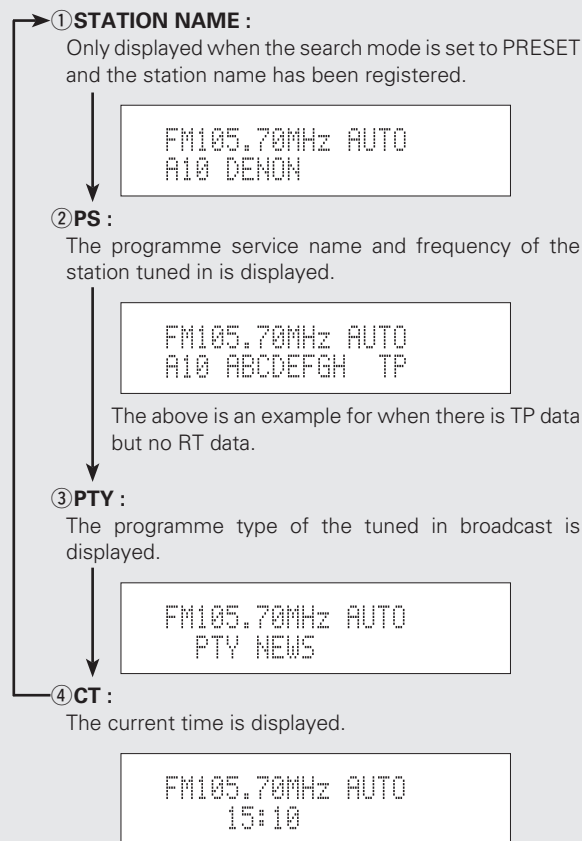

Last function memory

- The next time the power is set to the “on” mode, the unit is set to the same status (band, frequency, preset channel number, mode setting, etc.) as when the power was formerly set to the “standby” mode.
- The unit is also equipped with a back-up memory. This function provides memory storage when the power operation switch is off and with the power supply cord disconnected.

Initialization of the microprocessor

If the display or operation is abnormal, use the procedure described below to reset the microprocessor.

- Press **<ON/STANDBY>** or **[POWER]** to set the power to the “standby” mode, then unplug the unit’s power supply cord from the power outlet.
- While pressing both **<DIMMER>** and **BAND**, plug the unit’s power supply cord into a power outlet.
- Check that the entire display is flashing with an interval of about 1 second, and release your fingers from the 2 buttons.
 - The microprocessor will be initialized.



- If step 3 does not work, start over from step 1.
- When the microprocessor is reset, all the settings are restored to the factory default values.

Troubleshooting

If a problem occurs, first check the following:

1. Are the connections correct?

2. Is the unit being operated as described in the owner's manual?

If this unit does not operate properly, check the items listed in the table below. If the problem persists there may be a malfunction.

In this case, disconnect the power immediately and contact the retail outlet.

Symptom	Cause	Measures	Page
Power does not turn on when ON/STANDBY switch is pressed.	<ul style="list-style-type: none"> Power supply cord's plug is not plugged in to wall outlet. 	<ul style="list-style-type: none"> Plug the power supply cord in properly. 	4
Hissing noise is heard on FM broadcasts.	<ul style="list-style-type: none"> Antenna cable is not properly connected. Antenna is not pointing in the right direction. Radio waves are weak. 	<ul style="list-style-type: none"> Connect the leads properly. Point the antenna in the right direction. Install an outdoor antenna. 	4 4 4
Hissing or buzzing sound is heard on AM broadcasts.	<ul style="list-style-type: none"> Noise from a TV or interference in the signals sent from the broadcast station. 	<ul style="list-style-type: none"> Turn off the TV. Change the position of the loop antenna. Install an outdoor antenna. 	– 4 4
Booming sound (humming) is heard in AM broadcasts.	<ul style="list-style-type: none"> Signals transmitted over the power supply cord are modulated by the power source frequency. 	<ul style="list-style-type: none"> Insert the plug in the opposite direction. Install an outdoor antenna. 	– 4
Nothing happens when remote control buttons are pressed.	<ul style="list-style-type: none"> Are the batteries dead? Is the remote control unit too far away? Is there an obstacle between the remote control unit and the main unit? You have pressed the wrong button. Batteries are not set in their proper direction (⊕ and ⊖). 	<ul style="list-style-type: none"> Replace the batteries with new ones. Operate from closer to the main unit. Remove the obstacle. Press the desired button. Set the batteries in the proper direction. 	2 2 2 3 2
I can not get any sound.	<ul style="list-style-type: none"> Power connected amplifier not turned on. Connection leads to amplifier not made correctly. 	<ul style="list-style-type: none"> Turn on the amplifier properly. Connection leads to amplifier properly. 	– 4

Specifications

FM tuner section (Note: μV at 75 Ω , 0 dBf= 1×10^{-15} W)

- **Receiving range:** 87.5 MHz – 108.0 MHz
- **Antenna terminals:** 75 Ω Unbalanced
- **Usable sensitivity:** 1.0 μV (11.2 dBf)
1.2 μV (IHF)
- **S/N 50 dB sensitivity**
 - Monaural:** 1.6 μV (15.3 dBf)
 - Stereo:** 23 μV (38.5 dBf)
- **Image interference ratio:** 80 dB
- **IF interference ratio:** 100 dB
- **AM suppression ratio:** 50 dB
- **Effective selectivity:** 50 dB (± 400 kHz)
- **Capture ratio:** 2.0 dB
- **Frequency characteristics:** 20 Hz – 15 kHz: +0.5, –1.0 dB
- **Signal-to-noise ratio**
 - Monaural:** 77 dB (IHF), 73 dB (DIN)
 - Stereo:** 72 dB (IHF), 68 dB (DIN)
- **Total harmonic distortion**
 - Mono 1 kHz (at 75 kHz dev.):** 0.15 %
 - Stereo 1 kHz (at 67.5 kHz dev.):** 0.3 %
- **Stereo separation 1 kHz (WIDE):** 43 dB

AM tuner section

- **Receiving range:** 522 kHz – 1611 kHz
- **Antenna terminals:** Terminal type with loop antenna
- **Usable sensitivity:** 18 μV
- **Signal-to-noise ratio:** 53 dB

Others

- Power supply:** AC 230 V, 50 Hz
- Power consumption:** 10 W
1 W or less (Standby)
- Maximum external dimensions:** 434 (W) x 73 (H) x 286 (D) mm
- Mass:** 3.6 kg

Remote control (RC-1144)

- Batteries:** 3 V DC, R03/AAA Type (two batteries)
- External dimensions:** 48 (W) x 219 (H) x 22 (D) mm
- Mass:** 105 g (including batteries)

* For purposes of improvement, specifications and design are subject to change without notice.

Index

A

- AM loop antenna 4
- Auto preset 6
- Audio cable 4

D

- Dimmer 3

P

- Power cord 4
- Presetting radio stations 6
- Program Type (PTY) 8

R

- RDS (Radio Data System) 8 – 10
- Radio Text (RT) 9

T

- Traffic Program (TP) 9







DENON

www.denon.com

D&M Holdings Inc.
Printed in China 5411 10395 007D