

179450 USA/GRB A



Displays your heart rate as bpm and % of HR_{max}, average heart rate and exercise duration.



Allows you to set 7 exercise profiles™ for multi-phase exercise sessions with HR target zones and recovery calculation. Records complete files of the exercises.



Predicts your maximal oxygen uptake.



Reduces possible interference from other heart rate monitors.



Sports watch features.



Beat to beat measurement, relaxation rate (indicates the state of your physical recovery), online measurement with optional Polar IR Interface™.



Infra red communication allows two-way exchange of settings and exercise data with a PC.

S810i™
HEART RATE MONITOR **POLAR**®



Quick Guide



How to Start Measuring Your Heart Rate (BasicUse)

1. Place the transmitter around your chest and wet the electrodes. Place the receiver on your wrist.
2. Press and hold the OK button to start the measurement. The stopwatch and the exercise recording start. Your heart rate will appear in about 15 seconds.

How to Stop Measuring Your Heart Rate

1. Press the stop button. The stopwatch and other calculations stop. Heart rate measurement continues but exercise data is not recorded into a file anymore.
2. Press the stop button again. The receiver returns to Time of Day display.

Road Map

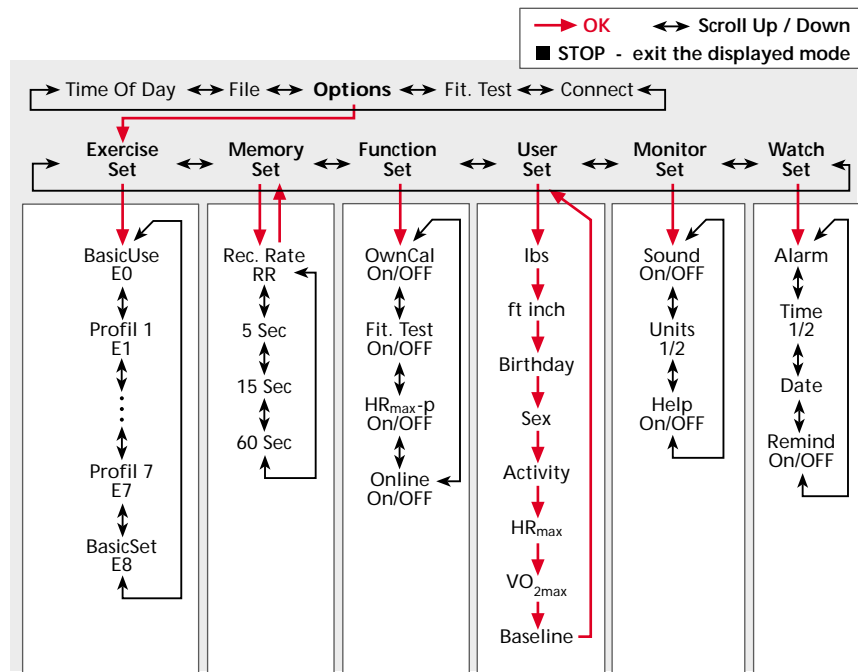

Dear Customer

Congratulations on purchasing a Polar Heart Rate Monitor! We are proud to assist you in achieving personal fitness and performance goals.

If you want to get even more out of your Polar Heart Rate Monitor during training, check our web sites for the best product and training tips, software updates and other value added services:

USA and Canada:
www.polarusa.com
Other countries:
www.polar.fi



Manufactured by:
 Polar Electro Oy
 Professorintie 5
 FIN-90440 KEMPELE
 Tel. +358-8-520 2100
 Fax +358-8-520 2300
www.polar.fi

Distributed in the USA by Polar Electro Inc.
 370 Crossways Park Drive
 Woodbury NY 11797-2050
 U.S.A.
 1-800-227-1314
www.polarusa.com

Distributed in Canada by Polar Electro Canada
 c/o Lanco Logistics Inc.
 4330 Joseph Dubreuil
 Lachine, Quebec
 CANADA, H8T 3C4
 1-888-918-5043



The Polar S810i and Polar Precision Performance™ software offer you various ways to customize your exercise sessions so they meet your personal needs.

For example, you can build up exercise profiles to guide you through various training sessions. Choose the functions that suit you best: OwnCal® calorie calculation, timers or recovery calculation, etc. Monitor your fitness level, and any long-term changes in it, by performing the quick and easy Polar Fitness Test™.

After training, you can review your exercise file and transfer it to your computer for analysis with the software. Or, you can transfer your heart rate to the computer in real time through an optional Polar IR Interface™. In addition, you can perform an over training test, included in the software, for thorough information about your body's recovery.

Please read this manual carefully to familiarize yourself with the Polar heart rate monitor. Here is where you can find the information you need to use and maintain your equipment. The function road map on the front cover is a quick guide to the versatile features of the Polar heart rate monitor; Please tear it off and save it for your reference.

Please refer to the glossary for special terms, display symbols and text explanations. The alphabetical index will help you quickly find answers to any questions that you might encounter while using your Polar heart rate monitor.

Thank you for choosing Polar!





CONTENTS

A. Getting Going 5

Heart Rate Monitor Parts	5
Buttons and Their Functions	6
Easy Start	8
How to Prepare the Wrist Receiver ...	8
How to Put the Transmitter On	9
How to Start Measuring	9
Your Heart Rate	9
How to Stop Measuring	9
Your Heart Rate	10
After Exercising	10
Modes and Their Functions	11

B. How to Enter Settings 14

User Information Settings	16
Exercise Settings	20
Selecting Exercise Type	22
Setting BasicSet exercise	22
Setting Timers	23
Setting Heart Rate Limits	23
Turning Heart Rate Limits on/off ...	23
Setting Recovery Calculation	24

Setting Profile Exercise	25
Setting Phases on/off	25
Setting Interval Calculation	26
Setting Interval Type	26
Setting Number of Intervals and Recoveries	28
Turning Heart Rate Limits on/off ..	28
Setting Heart Rate Limits	28
Setting Recovery Calculation	29
Naming Profiles	30
Setting Recording Rate	31
Turning Functions on/off	32
OwnCal Calorie Counter on/off	32
Fitness Test on/off	32
Predicted Maximum Heart Rate on/off	33
Online Recording to Computer on/off	33
Monitor Settings	34
Turning Activity/Button Sound on/off	34
Selecting Measuring Units	34
Turning Help on/off	35

Watch Settings	36
Setting Alarm	36
Setting Time of Day	36
Setting Date	37
Turning Reminders on/off	37
Setting Tips	38
Swap Time 1 or Time 2	38
Shortcut to Watch Settings	38
Swap Measuring Units	38
Swap Date, User ID Number, User Name and Logo	38
C. Exercise 39	
Heart Rate Measure Mode	39
Exercise Recording Mode	41
Turning Heart Rate Zone Alarm on/off	41
Illuminating the Display	42
Storing Lap and Split Time	42
Pausing the Exercise	43
Swapping the Displayed Exercise Information	43
Resetting the Stopwatch to Zero	45

Starting an Exercise Profile	46
Exercise Phase	47
Interval Period	47
Recovery Period	48
Interrupting an Exercise Profile	49
Exercising with BasicSet	49
Starting the Timers	49
Swapping the Heart Rate Limits	49
Starting the Recovery Calculation ...	50
Stopping the Exercise	50
Tips During Exercise	50
Swapping the Exercise Type	50
Swapping the Recording Rate of the Exercise	50
Resetting the Interval or Recovery Calculation of an Exercise Profile	50
Interrupting an Interval or Recovery Calculation of an Exercise Profile ...	51
Interrupting a Phase of an Exercise Profile	51
Heart Touch Function	51



A. GETTING GOING

D. How to Recall Training Information 52

Exercise Time	54
Recovery Information of BasicSet Exercise	55
Heart Rate Limits	55
Exercise Time within, above and below the Heart Rate Zones	55
Calorie Expenditure	55
Cumulative Calorie Count	55
Cumulative Exercise Time Count	56
Profile Exercise Information	56
Lap Information	58
Recorded Heart Rate Samples	59
Records File	59
Updating the Cumulative Counts to Zero	59
Deleting a File	60
Deleting all Files	60

E. Connection to Computer 61

Downloading Training Data to Computer	61
Uploading Settings from Computer	62

F. Polar Fitness Test 65

OwnIndex	65
Predicted Maximum Heart Rate	67
Fitness Test Settings	68
Carrying out the Test	68
Update OwnIndex and HR _{max} -p	70
Fitness Classes	71

G. Care and Maintenance 73

H. Precautions 75

I. Frequently Asked Questions 79

J. Technical Specifications 83

K. Limited Polar international guarantee 86

L. Disclaimer 87

M. Polar Glossary 88

Display Symbols	90
Display Texts	91
Index	95

Heart Rate Monitor Parts and Their Functions

The elastic strap holds the transmitter comfortably, yet firmly, in the correct position.

The transmitter detects your heart rate and transmits it to the wrist receiver.

The wrist receiver displays your heart rate and other data during exercise. Enter your personal settings into the receiver and analyze the exercise files after you're done.

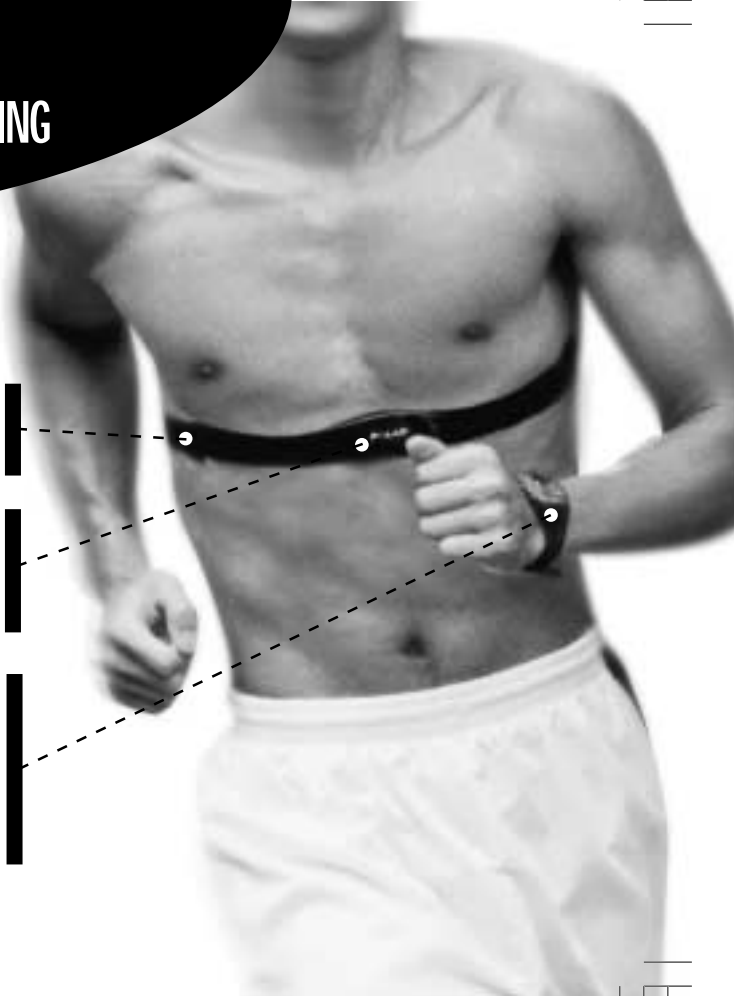



Buttons and Their Functions

- Signal/ Light** Turns the beep on or off.
Turns the backlight on.
- Reset** Resets the heart rate monitor.
- Stop Return** - Stops measuring the heart rate.
Exits the displayed mode and returns to the previous mode level.
Returns to the Time of Day display from any mode by pressing and holding the stop button.
- OK Accept** - Starts measuring the heart rate (start).
Enters the displayed mode shown on the lower level (start). Locks in your selection (ok). Records lap information (lap). The Help text (start, ok or lap) that appears on the display above the button indicates its use.

 SIGNAL/
LIGHT

RESET

 STOP

OK



 **Up**

Moves to the following mode. Increases the selected value.

 **Down**

Returns to the previous mode. Decreases the selected value.



Useful Tips

- Briefly pressing a button (approximately 1 second) will do different things than pressing and holding the button for a longer period of time (approximately 2 to 5 seconds). If you press the button for a longer period of time, you can use shortcuts.
- The buttons are slightly stiffer than those of an ordinary watch to prevent them from being pressed accidentally.
- You can always return to the Time of Day display from the Options setting or File recalling loops by pressing and holding the stop button.
- See the glossary for display symbols and text interpretation.

A 6

A 7





Easy Start

How to Prepare the Wrist Receiver

1. Since the display is blank when the receiver leaves the factory, you have to activate the wrist receiver by pressing the OK button twice, after which the Time of Day display appears. This is a one-off procedure; once you have turned on your receiver you can not turn it off anymore.
2. You may start measuring your heart rate right away using the default settings. However, the following settings are ones that it would be useful to change as soon as possible: Time of Day (see section "Watch settings") and personal user settings (see section "User information settings").
3. The receiver has various functions that you can use according to your personal training needs. For more information, see section "Modes and their functions". You can either manually enter the settings by pressing the receiver buttons or you can define your settings using Polar Precision Performance software, after which the data should be transferred from your computer to the wrist receiver.
4. Wear the wrist receiver as you would wear an ordinary watch. If you go biking, we recommend attaching the wrist receiver to a Polar Bike Mount™.

A 8



How to Put the Transmitter On

1. Attach the transmitter to the elastic strap.
2. Adjust the strap length to fit snugly and comfortably. Secure the strap around your chest, just below the chest muscles, and buckle it.
3. Lift the transmitter off your chest and **moisten the grooved electrode areas** on the back.
4. Check that the wet electrode areas are firmly against your skin and the Polar logo is in a central, upright position.

How to Start Measuring Your Heart Rate

1. Begin with the display that shows the time of day.
2. Keep the wrist receiver within 3 feet/ 1 meter of your transmitter.
3. Check that you are not near people that have heart rate monitors, high voltage power lines, televisions, mobile phones or other sources of electromagnetic disturbance.

A 9





4. Press the OK button to start measuring your heart rate. A heart symbol will start flashing and your heart rate (beats per minute) will appear in a maximum of 15 seconds.
5. Press OK again. The stopwatch starts running and you can start exercising. The exercise data will only be stored in a file if you have turned the stopwatch on.

How to Stop Measuring Your Heart Rate

1. Press the stop button. The stopwatch and other calculations stop. The heart rate measuring continues, although exercise data is no longer recorded.
2. Press the stop button again. The heart rate measuring stops. The receiver shows the Time of Day display again.

After Exercising

1. Carefully wash the transmitter with a mild soap and water solution.
2. Rinse it with pure water.
3. Dry the transmitter carefully with a soft towel.
4. Store the transmitter in a clean and dry place. Dirt impairs the conductivity and functioning of the transmitter. Sweat and moisture can keep the electrodes wet and the transmitter activated, which shortens battery life.

A 10



Modes and Their Functions

Your receiver has six main modes: Time of Day, Exercise, File, Options, Fitness test and Connection. The modes offer you the following features:

1. TIME OF DAY

- 12 h or 24 h time, alarm, date and weekday
- two time options
- backlight

In addition, the following functions can be uploaded from a computer and utilized:

- 7 alarm sound reminders
- your personal logo, user number or user name

2. EXERCISE

There are three optional exercise modes:

- simple BasicUse function without settings or exercise guiding functions
- Programmable Exercise Profile function with six exercise phases
- programmable BasicSet function with three adjustable target heart rate limits, timers and a recovery period

The following are in use during all three different exercise modes:

- three adjustable display options
- current exercise time (stopwatch)
- time of day
- lap and split time as well as the lap number

A 11





- current heart rate, average heart rate or a reading of your maximum heart rate in percentages
- calorie count for an exercise session
- graphic and numeric display options of relaxation rate

3. FILE

- up to 99 exercise files and one re-settable records file, which keeps track of cumulative calories and exercise time
- date and starting time of the exercise
- total exercise time
- average, maximum and minimum heart rate readings for the exercise session
- recovery information of BasicSet exercise
- heart rate limits used during exercise
- time spent in, above and below your target zones during exercise
- OwnCal calorie expenditure
- cumulative calorie expenditure
- cumulative exercise time
- profile information on the exercise phases
- lap information: best lap time; up to 99 lap and split times; current, average and maximum heart rate for each lap
- heart rate samples recorded in the preset recording rate

4. OPTIONS

- BasicUse with no settings, BasicSet with three heart rate limits, timers and a recovery period or seven programmable exercise profiles with



exercise phases. Each phase may include heart rate limits, intervals and recovery periods.

- heart rate for 1 minute, 15 seconds, 5 seconds or each heart beat is recorded.
- OwnCal calorie counter, fitness test, predicted maximum heart rate and online measurement*
- user-specific information: weight, height, date of birth, gender, activity level, maximum heart rate, maximal oxygen uptake and baseline for relaxation rate
- activity/button sound, measurement units and Help function
- alarm, time of day, date and reminders

5. FITNESS TEST

In this mode you can:

- perform the Polar Fitness Test
- recall your latest test results; OwnIndex and HR_{max-p} values
- update your user information to reflect your most recent OwnIndex and HR_{max-p} values

6. CONNECTION

In this mode you can:

- download recorded exercise information to your computer for detailed analysis with Polar Precision Performance software version 3 or later
- upload your receiver settings from your computer to receiver with Polar Precision Performance software version 3 or later

* An optional Polar IR Interface is required.

A 12

A 13





B. HOW TO ENTER SETTINGS



This section describes how to manually enter settings by pressing the receiver buttons. However, The receiver offers you a faster way as well: prepare your settings with Polar Precision Performance software and upload them to your receiver from your computer. See chapter “Uploading settings from computer”.

B 14



1. In the Time of Day display, scroll up or down until OPTIONS is displayed.
2. Press OK to enter the Options mode. EXERCISE SET is displayed.
3. Scroll up or down until the desired setting mode is displayed.
4. Press OK to start the settings.

- Move forward and backward by using the up or down buttons.
- Press OK to start adjusting the value.
- Scroll up or down to adjust the value.
- Press OK to lock in your selection.
- Move backward to the previous setting level by pressing the stop button.
- To return to the Time of Day display, wherever you are in the Options settings: Press and hold the stop button.
- The digits run faster if you press and hold the up or down button as you adjust the value. Release the button when approaching the desired value.
- On the display each function is presented by an abbreviated text. A flashing block on the display indicates how far you are in the setting mode.

B 15





User Information Settings



! In the User Set loop you can move forward only by pressing OK.

Measuring units depend on the settings in Options/ Monitor Set/ Unit 1 or Unit 2.

	Units 1	Units 2
Weight	kg	lbs
Height	cm	ft/ inch
Date of Birth setting order	day - month - year	month - day - year

1. In the Time of Day display scroll up or down until OPTIONS is displayed.
2. Press OK to enter the Options mode. EXERCISE SET is displayed.
3. Scroll up or down until USER SET is displayed.
4. Press OK to start the user information settings.

Weight (lbs or kg)

5. Scroll up or down to adjust your weight. Press OK.

Height (ft/ inch or cm)

6. Scroll up or down to adjust your height. Press OK.

Press and hold signal/ light button to change the units for weight or height.

B 16

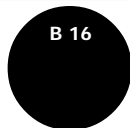

Date of Birth (Birthday)

7. Scroll up or down to select your month / day of birth. Press OK.
8. Day / Month appears. Scroll up or down to select the day / month. Press OK.
9. Year appears. Scroll up or down to adjust the year of birth. Press OK.

Units 1: setting order is day - month - year.
Units 2: setting order is month - day - year.

Sex

10. Scroll up or down to select your gender. Press OK.

Activity Level (Activity)

11. Scroll up or down to select your activity level for Polar Fitness Test. Press OK.

Assess your long-term physical activity level. Do not change your activity level description if your regular exercise habits have changed during the last six months.

Low You do not participate regularly in programmed recreational sport or heavy physical activity. Ex. you walk only for pleasure or occasionally exercise sufficiently to cause heavy breathing or perspiration.

Middle You participate regularly in recreational sports. Ex. you run 3-6 miles / 5-10 km per week or spend 1/2-2 hours per week in comparable physical activity or, your work requires modest physical activity.

B 17

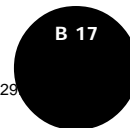



- High You participate regularly, at least 3 times a week, in heavy physical exercise. Ex. you run 6-12 miles / 10-20 km per week or spend 2-3 hours per week in comparable physical activity.
- Top You participate regularly in heavy physical exercise at least 5 times a week. Ex. you exercise to improve performance for competitive purposes.

Maximum Heart Rate Value (HR_{max})

12. Your age-predicted maximum heart rate value is displayed as a default setting when you set this value for the first time. **If you know your exact clinically tested current maximum heart rate value**, set the value by scrolling up or down.
13. Press OK.

If you do not know this value, update it in the Fitness Test mode after having carried out the Polar Fitness Test.

Maximal Oxygen Uptake Value (VO_{2max})

14. The wrist receiver suggests value 35 for females and value 45 for males as a default setting when you set this value for the first time. **If you know your exact clinically tested current maximal oxygen uptake value**, set the value by scrolling up or down.
15. Press OK.

If you do not know this value, update it in the Fitness Test mode after having carried out the Polar Fitness Test.



Baseline for relaxation rate

16. Scroll up or down to select your relaxation rate baseline. Press OK. USER SET appears.

The degree of relaxation rate is highly individual, therefore compare the value to your own baseline. To find out your personal baseline relaxation rate, you need to measure your relaxation rate in a recovered state. Follow the instructions below or refer to Polar Precision Performance software to easily determine your relaxation rate baseline. See also "Display Texts" / "RLX, Relaxation rate" section.

Relaxation Rate			
	Time	Example	Your Value
1	0:15	32	_____
2	0:30	33	_____
3	0:45	35	_____
4	1:00	34	_____
5	1:15	33	_____
6	1:30	35	_____
7	1:45	36	_____
8	2:00	33	_____
		271	_____
		/ 8	/ 8
Baseline		34	_____

1. Before the measurement, relax for 2-3 minutes.
2. Start measuring your heart rate by pressing and holding the OK button.
3. Press the up button until relaxation rate value (RLX) in milliseconds is displayed in the upper row. Or, if INT is displayed in the upper row press the down button first and then up button until relaxation rate value (RLX) is displayed.
4. Write down your relaxation rate each 15 seconds for 2 minutes.
5. Sum up the eight relaxation values and divide them by eight to obtain the average value. This is your baseline relaxation rate.

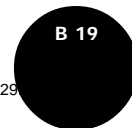



For getting the most of your relaxation rate measure your baseline relaxation rate:

- in the environment which best represents the time you will be using the relaxation rate.
- always in the same way (Ex., laying down), place and time.

Update the baseline value once a month or whenever you want to refer to your value in different situations.

To continue your settings, press the stop button. To return to the Time of Day display, press and hold the stop button.

Exercise Settings

When you start setting exercise preferences, you first select whether you want to pre-program an exercise profile or a BasicSet or exercise with the BasicUse option.

BasicUse (E0)

BasicUse is a simple mode for exercising. You do not have to do any settings before exercising with this Exercise mode. There are no heart rate limits in use in this mode. While exercising, you can see the following optional values on the display:

- current heart rate or average heart rate of the exercise
- stopwatch
- time of day

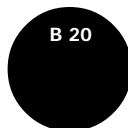

- split and lap times
 - relaxation rate
- Additionally, you can follow calories of your exercise session and percentage of your maximum heart rate, if you have set all the user information and turned the OwnCal calculator on.

Exercise Profile (E1-E7)

Exercise profile will guide you through the exercise with up to six pre-programmable phases. You can name the exercise profiles, Ex., by the exercise type. Profiles can be used for versatile exercises where different phases are successive, Ex., in interval training.

During exercise, you can see the same optional values as in the BasicUse mode. Heart rate limits and up to 30 interval and recovery periods can be set for each phase.

BasicSet (E8)

BasicSet is a pre-programmable exercise set, but simpler than an exercise profile. There are no phases available although three timers and a recovery period help you split up the exercise session. The three adjustable heart rate limits allow you to monitor your workouts, securing the correct intensity. During exercise, you can see the same optional values as in the BasicUse mode.





Selecting Exercise Type

1. In the Time of Day display scroll up or down until OPTIONS is displayed.
2. Press OK to enter the Options mode. EXERCISE SET is displayed.
3. Press OK to start the exercise settings. BasicUse E0, Profil E1-E7 or BasicSet E8 is displayed.
4. Scroll up or down until the desired exercise type is displayed. Press OK.

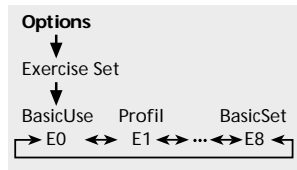

If you chose BasicUse (E0): to return to the Time of Day display, press and hold the stop button and skip the rest of the exercise settings.

If you chose Profil (E1-E7): continue to the step 5 of the chapter "Setting profile exercise/ Setting phases on/off".

If you chose BasicSet (E8): continue setting the functions for the BasicSet.

Setting BasicSet Exercise

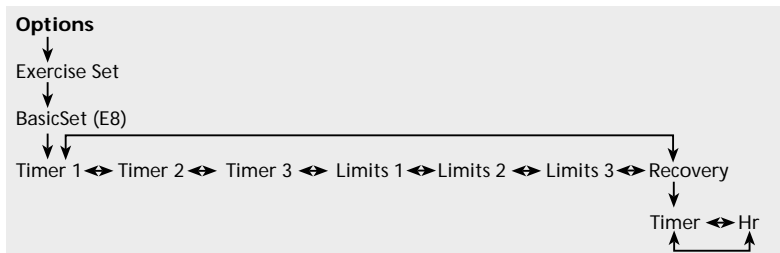

B 22



Setting Timers

If you start from the Time of Day display, repeat steps 1-4.

5. Scroll up or down until desired Timer is displayed. Press OK to start setting the timer.
 6. Scroll up or down to turn the timer on or off. Press OK. OFF: skip steps 7-8.
 7. Scroll up or down to adjust minutes. Press OK.
 8. Scroll up or down to adjust seconds. Press OK.
- Repeat until you have set all timers you want to use.

! You should select the timers on sequentially. Ex. you cannot set timer 2 on if timer 1 is off.

Setting Heart Rate Limits for the BasicSet

If you start from the Time of Day display, repeat steps 1-4.

5. Scroll up or down until desired Limits is displayed.
 6. Press OK to start setting the heart rate limits.
 7. Lim High appears. Scroll up or down to adjust your upper limit. Press OK.
 8. Lim Low appears. Scroll up or down to adjust your lower limit. Press OK.
- Repeat until you have set all heart rate limits you want to use.

Turning Heart Rate Limits for the BasicSet on/off

If you start from the Time of Day display, repeat steps 1-4.

5. Scroll up or down until desired Limits is displayed.
6. Press and hold the signal/light button to turn limits on or off. Release.

B 23





Setting Recovery Calculation for BasicSet

- A.** Time-based recovery Ends your recovery as you reach the preset time.
- B.** Heart-rate-based recovery Ends your recovery as you reach the preset heart rate.

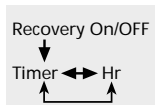

If you start from the Time of Day display, repeat steps 1-4.

5. Scroll up or down until Recovery is displayed.
6. Press OK to start setting the recovery on or off. On/OFF starts to flash.
7. Scroll up or down to set the recovery on or off. Press OK. OFF: Skip steps 8-10. On: TIMER or Hr starts to flash.
8. Scroll up or down to select the time-based or heart-rate-based recovery. Press OK.

- A.** RecoTime is displayed.
 9. Scroll up or down to adjust minutes. Press OK.
 10. Scroll up or down to adjust seconds. Press OK. Recovery TIMER appears.
- Or**
- B.** RecoHr is displayed.
 9. Scroll up or down to adjust the heart rate. Press OK. Recovery Hr appears.

To continue your settings, press the stop button. To return to the Time of Day display, press and hold the stop button.



Setting Profile Exercise

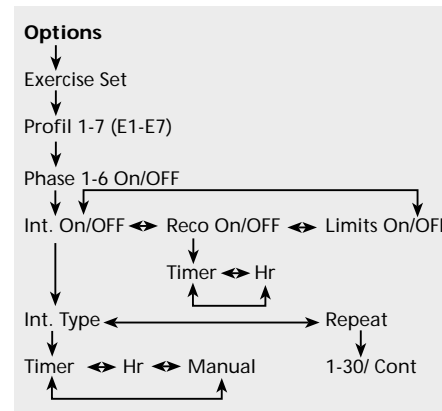

1. In the Time of Day display scroll up or down until OPTIONS is displayed.
2. Press OK to enter the Options mode. EXERCISE SET is displayed.
3. Press OK to start the exercise settings. BasicUse E0, Profil E1-E7 or BasicSet E8 is displayed.
4. Scroll up or down until the desired Profil E1-E7 is displayed. Press OK.

See an example of an exercise profile from chapter "Starting an exercise profile".





Setting Phases on/off

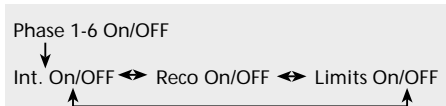

If you start from the Time of Day display, repeat steps 1-4.

5. Scroll up or down until the desired phase number is displayed.
6. Press OK to start setting the phase. On/OFF starts to flash.
7. Scroll up or down to set the phase on or off. Press OK. On: Int. and the phase number (P1) are displayed. OFF: continue setting the other phases from step 5. To continue your settings, press the stop button. To return to the Time of Day display, press and hold the stop button.

! You can not set the phase on, if you have not set the interval or recovery calculation on.

Setting Interval Calculation (Int.)

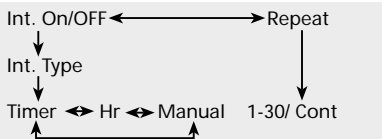

If you start from the Time of Day display, repeat steps 1-7.

8. Start with the display showing Int. (= interval).
9. Press OK to start setting the interval. On/OFF starts to flash.
10. Scroll up or down to set the interval on or off. Press OK.
On: Int. Type is displayed.
OFF: continue setting the recovery or heart rate limits for the phase. To continue your settings, press the stop button. To return to the Time of Day display, press and hold the stop button.



Setting Interval Type (Int. Type)

Select the interval type that will be used to end the interval calculation from three optional types:

- A. Time-based interval** Ends your interval when you have used the selected time.
- B. Heart-rate-based interval** Ends your interval as you reach the selected heart rate.
! When selecting heart-rate-based interval, recovery calculation must be set on.
- C. Manual interval** End the interval by pressing and holding OK.

If you start from the Time of Day display, repeat steps 1-10.

11. Start with the display showing Int. Type.
12. Press OK to start setting the interval type. TIMER, Hr or MANUAL starts to flash.
13. Scroll up or down to select the interval type that will be used to end the interval. Press OK.

If you chose manual interval type (MANUAL) skip steps 14 - 15.

- A. Time-based interval**
 14. Scroll up or down to adjust minutes. Press OK.
 15. Scroll up or down to adjust seconds. Press OK. TIMER appears.
- Or**
- B. Heart-rate-based interval**
 14. Scroll up or down to adjust the heart rate that will end your interval. Press OK. Hr appears.

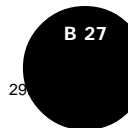



Setting the Number of Intervals and Recoveries (Repeat)

If you start from the Time of Day display, repeat steps 1-10.

You can set up to 30 intervals and recoveries (if set on) for each phase.

11. Scroll up or down until Repeat is displayed.
12. Press OK to start setting the number.
13. Scroll up or down to adjust the number. If you do not know in advance the precise number of the intervals select continuous interval by pressing and holding the up or down button until Cont is displayed. If you choose Cont, the intervals and recoveries will succeed until you manually stop the exercise or until 30 intervals and recoveries have been made. Press OK.

Continue setting the recovery or heart rate limits by pressing the stop button. Int is displayed. To return to the Time of Day display, press and hold the stop button and skip the rest of the exercise settings.

Turning Heart Rate Limits for Profile on/off

If you start from the Time of Day display, repeat steps 1-7.

8. Scroll up or down until Limits is displayed.
9. Press and hold the signal/light button to turn limits on or off. Release.

Setting Heart Rate Limits for Profile

If you start from the Time of Day display, repeat steps 1-7.

8. Scroll up or down until Limits is displayed.
 9. Press OK to start setting the limits.
 10. Lim High appears. Scroll up or down to adjust your upper limit. Press OK.
 11. Lim Low appears. Scroll up or down to adjust your lower limit. Press OK.
- Heart rate limits are used in the interval and recovery calculations.



Setting Recovery Calculation for Profile (Reco)

- A. Time-based recovery Ends your recovery as you reach the preset time.
- B. Heart-rate-based recovery Ends your recovery as you reach the preset heart rate.

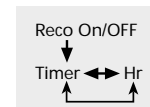

If you start from the Time of Day display, repeat steps 1-7.

8. Scroll up or down until Reco and the number of the phase (P1) are displayed.
 9. Press OK to start setting recovery on or off. On/OFF starts to flash.
 10. Scroll up or down to turn the recovery on or off. Press OK.
On: TIMER/ Hr is flashing.
OFF: continue setting the interval calculation or heart rate limits for the phase. To continue your settings, press the stop button. To return to the Time of Day display, press and hold the stop button.
 11. Scroll up or down to select time-based or heart-rate-based recovery. Press OK.
- A. RecoTime is displayed.
 - 12. Scroll up or down to adjust minutes. Press OK.
 - 13. Scroll up or down to adjust seconds. Press OK.
- Reco appears.

Or





B. RecoHr is displayed.

12. Scroll up or down to adjust the value. Press OK.
Reco appears.

! If you set both heart-rate-based interval and recovery, adjust your recovery heart rate to be smaller than the interval heart rate.

To continue your settings, press the stop button. To return to the Time of Day display, press and hold the stop button.

Naming Profiles

You can name the profiles, with seven letters, numbers or punctual marks. The available digits are: 0-9, space, A-Z, a-z, - % / () * + : ?.

1. In the Time of Day display scroll up or down until OPTIONS is displayed.
2. Press OK to enter the Options mode. EXERCISE SET is displayed.
3. Press OK. E0 - E8 is displayed.
4. Scroll up or down until desired profile (E1 - E7) is displayed.
5. Press and hold signal/light button. Adjustable letter is flashing.
6. Scroll up or down to select the desired mark. Press OK.
7. Repeat previous step until you have chosen all 7 letters.

To continue your settings, press the stop button. To return to the Time of Day display, press and hold the stop button.



Setting Recording Rate

You can program your receiver to record data in each heart beat, 5, 15 or 60 seconds intervals.

1. In the Time of Day display scroll up or down until OPTIONS is displayed.
2. Press OK to enter the Options mode. EXERCISE SET is displayed.
3. Scroll up or down until MEMORY SET is displayed.
4. Press OK to start the memory settings. Rec. Rate is displayed.
5. Scroll up or down to select the desired recording rate. As you change the recording rate you can see the memory left in the lower row. Press OK.

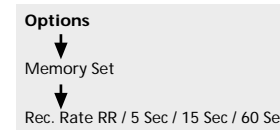

The recording time depends on the selected recording rate. The use of lap recording and profile function reduces the maximum exercise times. When the memory becomes full, you can continue exercising but the exercise is no longer recorded.

Recording rate	Maximum exercise time
RR (Each heart beat is recorded)	100 % is approx. 30 000 heart beats. The memory left is displayed in percentages
5 s	44 h 13 min
15 s	99 h 59 min in one file and total 120 h is approx. 5 days
60 s	99 h 59 min in one file and total 500 h is approx. 20 days

To continue your settings, press the stop button. To return to the Time of Day display, press and hold the stop button.

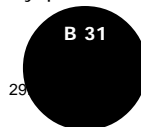



Turning Functions on/off

1. In the Time of Day display scroll up or down until OPTIONS is displayed.
2. Press OK to enter the Options mode. EXERCISE SET is displayed.
3. Scroll up or down until FUNCTION SET is displayed.
4. Press OK to start the function settings. OwnCal is displayed.

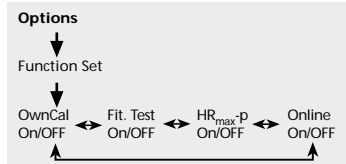

! To set the following functions on you have to set your user information. If lbs/kg are displayed as you start setting the function on, the wrist receiver points out that you have not set your all user information.

OwnCal Calorie Counter on/off

If you start from the Time of Day display, repeat steps 1-4.

5. Press OK to start setting the OwnCal function. On/OFF starts to flash.
6. Scroll up or down to set the OwnCal on or off. Press OK.

To get the most accurate OwnCal results, update the VO_{2max} setting and the HR_{max} setting with clinically measured values (if available). If you do not know your clinically measured values perform Polar Fitness Test and update the OwnIndex and HR_{max-p} settings in Fitness Test mode.

Fitness Test on/off

If you start from the Time of Day display, repeat steps 1-4.

5. Scroll up or down until Fit. Test is displayed.
6. Press OK to start setting the fitness test. On/OFF starts to flash.
7. Scroll up or down to set the fitness test on or off. Press OK.

B 32



Predicted Maximum Heart Rate on/off (HR_{max-p})

If you start from the Time of Day display, repeat steps 1-4.

5. Scroll up or down until HRmax-p is displayed.
6. Press OK to start setting the HR_{max-p} . On/OFF starts to flash.
7. Scroll up or down to set the HR_{max-p} on or off. Press OK.

HR_{max-p} can be turned on only if Polar Fitness Test is on.

Online Recording to Computer on/off

If you start from the Time of Day display, repeat steps 1-4.

5. Scroll up or down until Online is displayed.
6. Press OK to start setting the online recording. On/OFF starts to flash.
7. Scroll up or down to set the online recording on or off. Press OK.

To use this function you need an optional Polar IR Interface.

To continue your settings, press the stop button. To return to the Time of Day display, press and hold the stop button.

B 33





Monitor Settings

1. In the Time of Day display scroll up or down until OPTIONS is displayed.
2. Press OK to enter the Options mode. EXERCISE SET is displayed.
3. Scroll up or down until MONITOR SET is displayed.
4. Press OK to start the monitor settings. Sound is displayed.

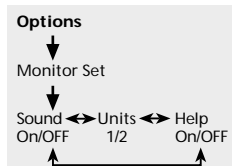

Turning the Activity/Button Sound on/off

If you start from the Time of Day display, repeat steps 1-4.

5. Press OK to start setting the sound. On/OFF starts to flash.
6. Scroll up or down to set sound on or off. Press OK.

Your receiver has two distinct sounds: activity/button sound and alarms. This setting includes only the activity/button sound settings.

- Certain Measure and Exercise mode settings will be audible: start, stop, heart touch function, phase start, phase end and recovery calculation end.
- Heart rate zone alarms, watch alarm or fitness test alarm will make a distinctly different sound.

Selecting Measuring Units

If you start from the Time of Day display, repeat steps 1-4.

5. Scroll up or down until Units is displayed.
6. Press OK to start setting the units. 1 or 2 starts to flash.

B 34



7. Scroll to the unit which best suits you. Press OK.

There are two different user information settings.

Units 1: kg, cm, day-month-year **Units 2:** lbs, feet, month-day-year

Turning Help on/off

If you start from the Time of Day display, repeat steps 1-4.

5. Scroll up or down until Help is displayed.
6. Press OK to start setting the Help function. On/OFF starts to flash.
7. Scroll up or down to set the Help on or off. Press OK.

If you turn Help on, the flashing arrows guide you to use the correct buttons in the Options and File modes. If you want to change the middle row information during exercise, the function name will appear for a few seconds.

To continue your settings, press the stop button. To return to the Time of Day display, press and hold the stop button.

B 35





Watch Settings

1. In the Time of Day display scroll up or down until OPTIONS is displayed.
2. Press OK to enter the Options mode. EXERCISE SET is displayed.
3. Scroll up or down until WATCH SET is displayed.
4. Press OK to start the watch settings. ALARM is displayed.



Setting Alarm

If you start from the Time of Day display, repeat steps 1-4.

5. Press OK to start alarm settings.
 -) On/OFF starts to flash.
6. Scroll up or down to set alarm on or off. Press OK.
 - 24 h: skip step 7.
7. 12 h: AM/ PM starts to flash. Scroll up or down to select AM or PM. Press OK.
8. The hours start to flash. Scroll up or down to adjust the hours. Press OK.
9. The minutes start to flash. Scroll up or down to adjust the minutes. Press OK.

OFF: skip steps 7 - 9.

When the alarm comes on, it will sound for one minute. You can turn it off by pressing any of the five buttons.

Setting Time of Day

If you start from the Time of Day display, repeat steps 1-4.

5. Scroll up or down until TIME1/ TIME 2 is displayed.
6. Press OK to start setting the time of day.

B 36



7. Time is flashing. Scroll up or down to select time 1 or time 2. Press OK.
8. 12 h/ 24 h starts to flash.
 - Scroll up or down to select 12 h or 24 h time mode. Press OK.
 - 24 h: skip step 9.
9. AM/ PM starts to flash. Scroll up or down to select AM or PM. Press OK.
10. The hours start to flash. Scroll up or down to adjust the hours. Press OK.
11. The minutes start to flash. Scroll up or down to adjust the minutes. Press OK.

Setting Date

If you start from the Time of Day display, repeat steps 1-4.

5. Scroll up or down until DATE is displayed.
6. Press OK to start adjusting the date.
7. Month / Day appears. Scroll up or down to select the desired value. Press OK.
8. Day / Month appears. Scroll up or down to select the desired value. Press OK.
9. Year digits start to flash. Scroll up or down to select the year. Press OK.

12 h Time mode:
month - day - year.
24 h time mode:
day - month - year.

Turning Reminders on/off

If you start from the Time of Day display, repeat steps 1-4.

5. Scroll up or down until REMIND is displayed.
6. Press OK to start setting the reminders.
7. Scroll up or down until desired reminder is displayed. The number of the reminder is displayed in the corner of the display.
8. Press OK. On/OFF starts to flash.
9. Scroll up or down to set the reminder on or off. Press OK.

B 37



You can upload 7 reminders, each including time and name, to your wrist receiver from Polar Precision Performance software.

The reminder sounds an alarm only when time of day is displayed. When the reminder alarm comes on, it will sound for 15 seconds. You can turn it off by pressing any of the buttons except the signal/light button.

Erase the reminder text by pressing any of the buttons except the signal/light button.

To continue your settings, press the stop button or to return to the Time of Day display, press and hold the stop button.

Setting Tips

Swap Time 1 or Time 2

In the Time of Day display press and hold the down button. Time 1 or Time 2 is displayed in the uppermost row for a couple of seconds. Displayed time will now be used in all watch and alarm functions. If you chose time 2, "2" is displayed in the Time of Day display.

Shortcut to Watch Setting Loop

Press and hold the signal/light button for a few seconds to enter into the watch setting loop. If you want to skip some parts and go directly to a watch function, scroll up or down button until the desired watch function is displayed. Set the function as in the "Watch settings" section.

Swap Measuring Units

As you set your user information for weight and height, press and hold the signal/light button until the units are swapped. Release the button.

Swap Date, User ID Number, User Name and Logo

You are able to set a user ID number, user name and logo with the Polar Precision Performance software. These settings are shown on the upper row of the Time of Day display. You can swap between the user ID, user name, logo and date by pressing and holding the up button.

B 38

C. EXERCISE

Time of Day



Heart rate measure mode



Exercise recording mode

You can use two modes while exercising: Measure or Exercise mode. In the Measure mode you can see your heart rate but exercise information will not be recorded. In the Exercise mode your exercise is recorded. Stopwatch and other calculations are also started.

Heart Rate Measure Mode

1. Wear the transmitter and the wrist receiver as described in "Easy start" section.
2. To ensure that the code search will find a signal:
 - Keep the wrist receiver within 3 feet/ 1 meter of your transmitter.
 - Check that you are not near: people with heart rate monitors, high voltage power lines, televisions, mobile phones, cars, motor driven exercise equipment or other electromagnetic disturbance.

C 39



- Start from the Time of Day display by pressing the OK to start measuring your heart rate. A heart symbol will start flashing and your heart rate in beats per minute will appear in max. 15 seconds. The frame around the heart symbol indicates that the heart rate reception is coded. The receiver returns automatically to the Time of Day display within 5 minutes if there is no heart rate reception.

The following displays start to alternate as you enter the Measure mode:

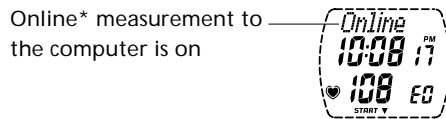
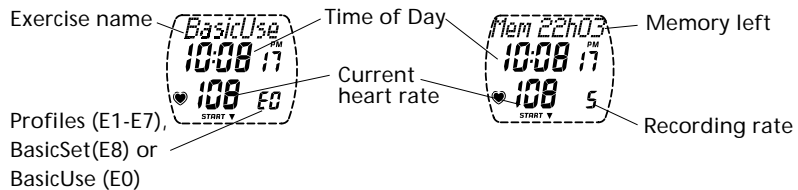

*To use this function you need an optional Polar IR Interface.

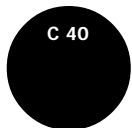

Exercise Recording Mode

If you are continuing from the Measure mode, press OK.

Or, if you are starting from the Time of Day display, press and hold OK.

- ! If BasicUse exercise starts, even if you have set an exercise profile on please check that you have set at least one of the exercise profile functions on.

Exercise information will be stored in an exercise file only when the stopwatch is running. The ongoing recording is indicated with a graphic bar that runs continuously on the display.

If there is 00 / - - reading on the display, there is no heart rate reception. Bring the wrist receiver up to your chest near the transmitter's Polar logo. The receiver will look for another heart rate signal.

- 💡 At the start of your workout, exercise time is displayed in minutes and seconds. When you have exercised more than 60 minutes, exercise time is displayed in hours and minutes.

Turning the heart rate zone alarm on/off

Press and hold the signal/light button. When appears on the display the zone alarm is on. A beeping noise will sound with each heart beat to alert you that your heart rate is outside the set limits. If you do not want to use the zone alarm the flashing heart rate reading indicates if your heart rate is outside the limits. This function can be used if you have turned on heart rate limits in Profile and BasicSet exercises.

In addition to the alarm you can see:

- ▲ if you are exercising above heart rate zone.
- ▼ if you are exercising below heart rate zone.

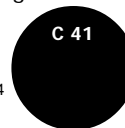



You have three optional Exercise modes depending on the selected exercise:

- BasicUse (E0)
- BasicSet (E8)
- Profiles (E1-E7)

The following functions can be used during all three optional Exercise modes.

Illuminating the Display

Press the signal/light button.

After you use backlight once in the Measure mode, the receiver automatically illuminates the display when you start /stop the exercise session, store lap information end an interval and recovery calculation.

Storing Lap and Split Time

Press OK to store lap and split time.

First

- Lap time
- Average heart rate of the lap
- Number of the lap



Then

- Split time

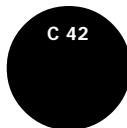

Receiver automatically stores a lap time when you stop recording an exercise. You can store 99 laps if you have not used the profile function. After storing 99 laps FULL appears for a few seconds every time you take a lap. You can continue taking laps but they will not be recorded. The wrist receiver continues recording all other information of the exercise, except lap and Profile information.

Pausing the Exercise

Press the stop button.

The exercise recording, stopwatch and other calculations are paused. To continue them, press OK. Or, to return to the Time of Day display, press and hold the stop button.



The receiver automatically returns to the Time of Day display within 5 minutes if you forget to quit the heart rate measuring after having stopped the stopwatch and taken the transmitter off your chest.

Swapping the Displayed Exercise Information

There are three display options, which you can swap between by pressing the down button. The receiver saves the upper and lower row settings for the three display options. If the Help function is on, the name of the selected function appears for a few seconds.

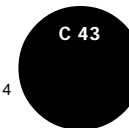
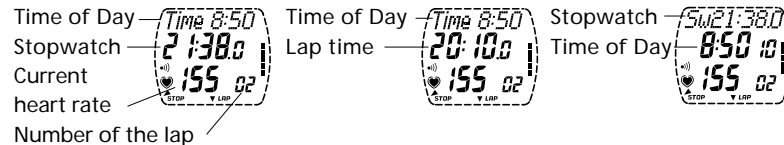



! When you have set a profile exercise on, you will have one extra display. You can change the lower row for this display. See the alternative phase displays from "Starting an exercise profile" / "Exercise phases" section.

Number of current interval.
Number of preset intervals.
Countdown timer.
Phase number.



You can configure the middle and upper rows during heart rate measurement.

Select the Middle Row Information

1. Press the down button to select the desired display alternative. When you swap the middle row information, the upper and lower rows change also. Continue selecting the upper and lower rows.

Select the Upper Row Information

2. Press the up button to select from the following: Time of Day (Time), stopwatch (Sw), lap time (Lp), relaxation rate (Rlx) or calorie expenditure (Cal), if OwnCal is set on.

Additionally you will have a graphical relaxation rate display in the upper row. Relaxation rate helps you recognize stressful situations. The degree of relaxation rate is highly individual, therefore compare the value to your own baseline. See also section "User Information Settings" and "Rlx, Relaxation rate" in "Display Texts" section.

C 44



The bar indicates the baseline of your relaxation rate.



Bar of dots indicates the current relaxation rate in relation to your baseline value. If you are in a more relaxed state than the baseline value, the bar of dots is on the right side of the baseline bar, and vice versa.

You cannot select the same displayed function to the upper and middle row i.e. the option on the middle row is no longer available for the upper row.

Select the Lower Heart Rate Information row

3. Press and hold the down button to select from the following: Current heart rate, average heart rate (AVG) or the reading in percentages of your maximum heart rate (% MAX) if you have set your user information.

You can only change the displayed function of the lower row if the stopwatch is on.

Resetting the Stopwatch to Zero

As a result of resetting your stopwatch the recorded file is deleted.

1. Pause your exercise by pressing the stop button.
2. Press and hold the down button until the stopwatch is reset. "Reset" stops flashing as the stopwatch is reset. Release. If you are resetting a profile exercise repeat step 2.
3. Press OK to restart the stopwatch and recording or to return to the Time of Day display, press and hold the stop button.

C 45





Starting an Exercise Profile (E1-E7)

1. Start from the Time of Day display. Press OK to enter the Measure mode.
2. If you want to swap the profile (E1-E7), press and hold the up button until the exercise is swapped. Release. Repeat until desired profile is displayed.
3. To start exercising and recording the exercise press OK.

Profile function automatically guides you through the exercise. In order to hear the activity sounds when the phase starts and stops make sure the activity/button sound is on. When the stopwatch starts running  indicates that profile function is on. As exercise ends the receiver automatically starts a BasicUse exercise, which is recorded in the same file as the exercise profile.

Example of a exercise profile structure:

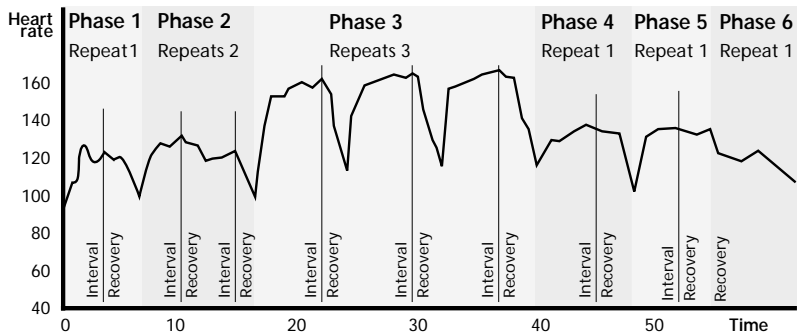

C 46



Exercise Phase (P1-P6)

Each exercise profile may include up to six pre-programmable exercise phases. Each phase may include up to 30 interval and recovery periods, which alternate continuously through the phase.

Interval Period

1. First Preset heart rate limits (if set on).
2. Then One of the following is displayed depending on your settings:
A. manual, **B.** time-based or **C.** heart-rate-based interval.



A. Manual interval



- Number of set intervals. (C means you have set continuous intervals)
- Current interval number.
- Stopwatch.
- Phase number.

If you selected manual interval, your interval will end as you press and hold OK.

Or

B. Time-based interval



- Countdown timer.
- If you selected time-based interval, your interval will end as you reach the preset time.

Or

C. Heart-rate-based interval



- The difference between the preset interval heart rate and current heart rate.
- If you selected heart-rate-based interval, your interval will end as you reach the preset heart rate reading.

C 47





- 3. At the end of interval
- Interval duration.
- Average heart rate of the interval.

When your intervals end, the wrist receiver automatically continues following the preset function, recovery calculation or the following exercise phase.

Recovery Period

One of the following is displayed depending on your settings:

A. time-based recovery or **B.** heart-rate-based recovery.

A. Time-based recovery



- Recovery countdown timer.
- Current heart rate.

Or

B. Heart-rate-based recovery



- The difference between the preset recovery heart rate and current heart rate.
- Current heart rate.

You will hear two beeps when the recovery calculation is done.



- At the end of recovery
- Recovery duration.
- Drop in your heart rate.

C 48



After the last phase has ended the receiver automatically continues exercise recording with BasicUse mode.

Interrupting an Exercise Profile

1. Press the stop button to pause the exercise.
2. Press and hold the stop button to return to the Time of Day display.

Or

Press the stop button. BasicUse appears. You can continue measuring your heart rate in this mode (Measure mode). To continue exercising with BasicUse and recording your exercise information press OK. Repeat steps 1 and 2 to return to the Time of Day display.

Exercising with BasicSet (E8)

In BasicSet, you can continue using the functions in the “Exercise recording mode” section.

Starting the Timers

If timers are set on, they automatically start running once you start the stopwatch. Timers alternate in the following order: timer 1, 2, 3, 1, 2, 3, etc. At the end of timer 1 you will hear 1 beep, at the end of timer 2 you will hear 2 beeps and at the end of timer 3 you will hear 3 beeps. Timers stop running when you stop the stopwatch.

Swapping the Heart Rate Limits

Press and hold the up button. Repeat until the desired limits are displayed.

C 49





Starting Recovery Calculation

To start the recovery calculation, press and hold the OK button. Depending on your setting RecoHr or RecoTime appears in the upper row of the display. See "Starting an exercise profile"/ "Recovery calculation" section for the displayed information during the recovery calculation. After the recovery calculation is done the exercise is paused. You can continue the exercise by pressing the OK button after the recovery calculation. If you do another recovery calculation, the previous recovery information will be deleted.

Stopping the Exercise

1. Press the stop button to pause the exercise.
2. Press and hold the stop button until time of day is displayed. Your lap and split time are automatically recorded, when you end the exercise.

Tips during the Exercise

Swapping the Exercise Type (E0-E8)

In the Measure mode press and hold the up button. Release. Repeat until desired exercise is displayed.

Swapping the Recording Rate of the Exercise (rr, 5 s, 15 s or 60 s)

In the Measure mode press and hold the down button. Release. Repeat until desired recording rate is displayed.

Resetting the Interval or Recovery Calculation of an Exercise Profile

Press the stop button to pause the exercise.

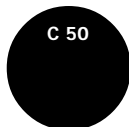

Reset the calculation by pressing and holding the down button. Reset Int? (=interval) or Reset Re? (=recovery) is displayed until the calculation is reset. To restart the same calculation press the OK button or to reset the exercise, press and hold the down button.

Interrupting an Interval or Recovery Calculation of an Exercise Profile

Press and hold the OK button during your profile exercise to interrupt the calculation. The following section automatically starts. Ex. if you interrupt an interval your recovery calculation (if set on) automatically starts.

Interrupting a Phase of an Exercise Profile

Press the stop button to pause the exercise. Press and hold the OK button. The following phase automatically starts. If you have done all the preset phases the BasicUse exercise starts.

Heart Touch Function

The heart touch function is activated as you bring the wrist receiver near the transmitter's Polar logo.

You have three display alternatives for the heart touch function. To select you heart touch display, use your Polar Precision Performance software:

- Checking the current heart rate limits
- Swapping the display options
- Storing lap time

During the heart touch, the backlight is on for a couple of seconds, if you have already used the backlight during the exercise.

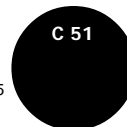



D. HOW TO RECALL TRAINING INFORMATION



The Polar heart rate monitor starts saving exercise information to a file as you start the stopwatch. You can recall the information in the File mode. In the File mode there are up to 99 exercise files and a record file, which keeps track of the cumulative values.



D 52



Your first file is F1, then F2 and so on, until you have recorded maximum 99 exercise files. The bigger the file number the more recent it is.

Some information alternates on the display automatically. You can make the information alternate faster by pressing the OK button, Ex., the target heart rate zone information.

Exercise File

1. In the Time of Day display scroll up or down until FILE is displayed.
2. Press OK to enter the File mode. The main information of your file is displayed.

Starting date and time alternate on the display.

Exercise name.

File number.

BasicUse E0,

Profil E1-E7 or

BasicSet E8.

3. Scroll up or down until the desired file is displayed.
4. Press OK to start recalling an exercise file. Exe. Time is displayed.

- Move forward and backward within file loops with up or down buttons.
- Press OK to enter a file or to enter a deeper level in the file loop.
- Press the stop button to move backward to the previous file level.
- To return the Time of Day display, press and hold the stop button.

D 53





Exercise File (F1-F99)

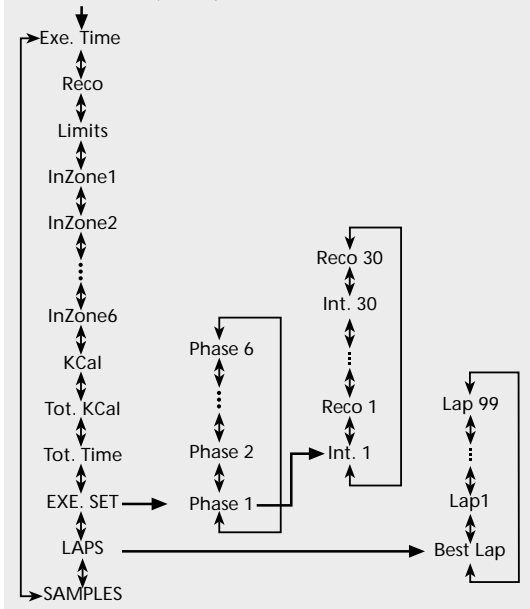

Exercise Time (Exe. Time)

The exercise time is the amount of time that you have exercised with the stopwatch running. Average, maximum and minimum heart rates of your exercise alternate on the display. To continue recalling the file, scroll up or down.

D 54



Recovery Information of BasicSet Exercise (Reco)

Time-based recovery
Recovery duration.
Drop in your heart rate.



Or

Heart-rate-based recovery
Time it took reach the preset heart rate reading.
Drop in your heart rate.

Heart Rate Limits (Limits)

Settings of the heart rate limits alternate on the display. Limits 1 are used for heart rate zone 1, limits 2 for zone 2, etc.

Exercise Time within, above and below the Heart Rate Zones

Indicates the exercise time, which you have spent within (InZone), above and below each heart rate limits during the entire exercise.

Calorie Expenditure (KCal)

You will see how many kilocalories you have expended during the exercise.

Cumulative Calorie Count (Tot. KCal)

Calculates the cumulative calories expended during several exercise sessions starting from the previous value stored in the records file. This function allows you to follow the calorie count as a gauge of effective exercise Ex. during one week.

D 55





Cumulative Exercise Time Count (Tot. Time)

This function counts cumulative exercise time expended during several exercise sessions starting from the previous value stored in the records file. It allows you to follow the exercise time count as a gauge of amount of exercise Ex. during one week.



Your cumulative total time is displayed in hours and minutes until 99 hours 59 minutes is reached. After this your cumulative exercise time is displayed in hours until 9999 hours is reached.

Profile Exercise Information (EXE. SET)

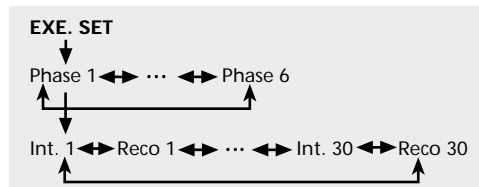

Start with the display showing EXE. SET.
Profile exercise time.
Profile number.

1. Press OK to start recalling the profile exercise information.
2. Scroll up or down to see the information on exercise phases.



Phase number.
Phase duration.
Average heart rate of intervals and recoveries.

D 56



3. Press the stop button to return to the previous file level and skip steps 4 and 5, or continue recalling more detailed information of the phase by pressing OK.
4. Scroll up or down between intervals (Int) and recoveries (Reco).

Interval Information

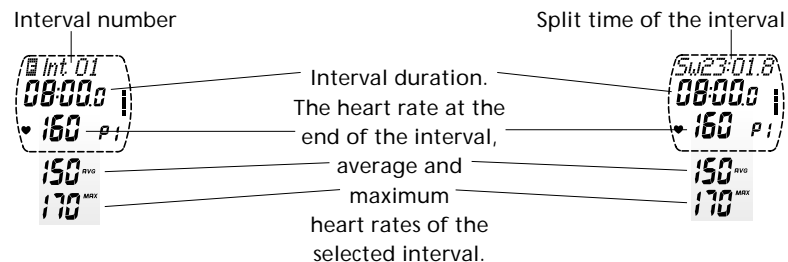

Recovery Information

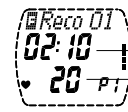

Time-based recovery
Recovery duration.
Drop in your heart rate.

Or



Heart-rate-based recovery
Time it took reach the preset heart rate reading.
Drop in your heart rate.

D 57





- To continue recalling information on the other phases, press the stop button. To continue recalling, Ex., lap information press the stop button twice. Scroll up or down until LAPS is displayed.

Lap Information (LAPS)

Start with the display showing LAPS and the number of recorded laps.

- Press OK to start recalling the lap information.
- Scroll up or down to see the following information:

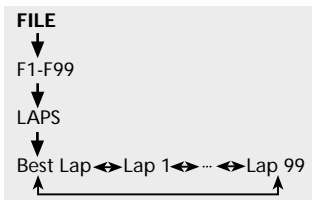

Best Lap

Shortest lap time.

The number of the best lap.

The best lap information is displayed if you have stored at least 3 laps. The best lap can not be the last lap.

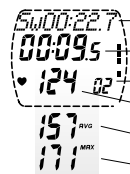

Laps

Split time.

Lap time.

Lap number.

The heart rate at the end of the lap,

average and

maximum heart rates of the lap.

Press the stop button to exit the LAPS display.

D 58



Recorded Heart Rate Samples

You can recall detailed heart rate information of an exercise from the sample file. Start with the display showing SAMPLES.

- Press OK to start recalling the recorded samples of your exercise information. The following information is displayed: The RR reading in milliseconds (ms), the sample number (S1 - If the RR recording rate is turned off), the time when the heart rate sample occurred and heart rate.
- Scroll up or down the samples.
Press and hold the stop button to return to the Time of Day display.



Records File

This file is updated each time your exercise is recorded to file.

- In the Time of Day display scroll up or down until FILE is displayed.
- Press OK to enter the File mode.
- Scroll up or down until Records is displayed.
- Press OK to enter the records file. Tot. KCal is displayed.

You will have a count for cumulative calories expended during several exercise sessions starting from the previous resetting.

- Scroll up or down to see the cumulative exercise time (Tot. Time) starting from the previous time resetting.

You can now return to the Time of Day display by pressing and holding the stop button or continue updating your cumulative counts.

Updating Your Cumulative Counts to Zero

- Once you have updated the cumulative count you cannot retrieve it. Start with the display showing Tot. KCal or Tot. Time in the records file.

D 59





1. Press OK to start updating the desired total count. Reset appears and the value starts to flash.
2. Press and hold the down button. Reset starts to flash. You can still cancel the previous setting by releasing the down button before the value is updated. If you are sure that you want to update the value keep holding the down button until value is updated. Release.
3. Press the stop button to exit the reset display. Press and hold the stop button to return to the Time of Day display.

Deleting a File

1. In the Time of Day display scroll up or down until FILE is displayed.
2. Press OK to enter the File mode.
3. Scroll up or down until desired exercise file is displayed. Press and hold the signal/light button. DELETE FILE and file number are displayed.
4. Press OK. The receiver confirms if you want to delete a file (Are you sure).
5. Press OK to delete the selected file.
6. Press stop to exit the file. Wait appears. The receiver reorganizes your file, which takes few seconds.
7. Press stop to return to the Time of Day display.

Deleting All Files

1. In the Time of Day display scroll up or down until FILE is displayed.
2. Press and hold the signal/light button. DELETE FILES is displayed.
3. Press OK. The receiver confirms if you want to delete all files (Are you sure).
4. Press OK to delete all exercise files.
5. Press stop to return to the Time of Day display.

D 60



E. CONNECTION TO COMPUTER



There is two-way communication between Polar and a computer. The Polar Precision Performance software offers an easy way to analyze training data. A training log makes it possible to plan future training. Wrist receiver settings can be uploaded from the software or manually entered. After preparing your settings you can upload options lock to ensure that your settings will not change. You must deactivate the options lock from the "user features" of your software.

Downloading Training Data to Computer

! For IR communication you need an IrDA port and Windows® 98 operating system or later in your computer.

If you do not have an IrDA port in your computer you need one of the following:

- A) an optional Polar IR Interface for RS-232 port and Windows® 95 operating system or later in your computer **or**

D 61





- B) an optional Polar IR Interface for USB port and Windows® 98 operating system or later in your computer.

Install the Polar Precision software (version 3 or later) first, then connect the optional Interface to the corresponding port of the computer before starting the software.

1. Start the Polar Precision Performance software.
2. Scroll up or down until CONNECT is displayed in the receiver display. Point the infrared window of the receiver towards the infrared window of the computer or an optional Interface. The maximum infrared transfer distance is 8" / 20 cm and the infrared transfer angle 15 degrees.
3. On the toolbar of the software, click on the heart rate monitor Connection icon  and hold the receiver steady. A new window "Infrared Connection" appears.
4. The receiver automatically starts to communicate with the software as Infrared appears. Follow the instructions on the computer screen to proceed with downloading exercise files or uploading heart rate monitor settings.

Uploading Settings from Computer

Your Polar heart rate monitor offers you the option of preparing your settings with Polar Precision Performance software. You are also able to set following functions with the software:

- a user ID, user name or logo for easier receiver recognition in multi-user situations
- the heart touch function to show the current heart rate limits, store a lap time or swap the display options during your exercise
- names and alarm times for 7 reminders
- options lock function on or off

You may upload settings from a computer to a wrist receiver either via IR communication or via audible Polar UpLink. For IR communication please see the previous chapter "Downloading Training Data to Computer". For the polar UpLink communication proceed as follows:

1. Start the software.
2. If the receiver is in the Time of Day display scroll up or down until CONNECT is displayed.
3. Place the receiver less than 4" / 10 cm from the loudspeaker.
4. Activate the upload function of the software. Do not move the receiver during the data transfer.
5. The receiver automatically starts to upload the information as UpLink appears. You will hear a chirping sound while information is transferred to the receiver. The receiver automatically returns to the Time of Day display after data transfer.

If the data transfer was unsuccessful bring the receiver closer to the loudspeakers or turn the volume level of the loudspeakers up.





! To be able to upload the settings from Polar Precision Performance software via Polar UpLink, you need a personal computer with a sound card (compatible with SoundBlaster™) and dynamic loudspeakers or headphones.

Online Recording

You can perform Online Recording with the Polar S810i heart rate monitor, Polar Precision Performance software (version 3 or later) and optional Polar IR Interface.

1. **To start recording:** See how to turn the Online measurement on in B: "Online Recording to Computer on/off" section. Select at the software Options - Preferences - Hardware tab. Select in the Advanced pane on the Online Recording field Polar S810i+IR Interface. Press OK. Place the wrist receiver within the reception range. Point the infrared window of the receiver towards the window of the Interface. Wear the transmitter. Start from the receiver's Time of Day display and press OK to activate the Heart rate monitor. If you like to store the recording press the OK button once more to start the stopwatch and recording. Select Tools - Online Recording at the software and press the Start button on the Online Recording panel.
2. **To stop recording:** In the software, press the Stop button and then press the Close button. Select the person to whom the file will be saved. The exercise will be added to the selected person's Diary data. Press the Stop button of the receiver.



F. POLAR FITNESS TEST



The Polar Fitness Test is an easy, safe and quick way to estimate individual maximal aerobic power and to get predicted maximum heart rate value. The Polar Fitness Test is targeted to healthy adults.

OwnIndex

OwnIndex is a value which is comparable to maximal oxygen uptake (VO_{2max}), a commonly used descriptor of aerobic fitness. Cardiovascular (aerobic) fitness relates to how well your cardiovascular system works to transport and utilize oxygen in your body. The stronger and more efficient your heart is, the better the cardiovascular fitness is. VO_{2max} is a good indicator of performance capability in endurance sports.





If you want to improve your cardiovascular fitness, it takes a minimum of 6 weeks on an average to see a noticeable change in OwnIndex. Less fit individuals see progress even more rapidly and for more fit individuals more time is needed. The better the cardiovascular fitness of an individual, the smaller the improvements in OwnIndex.

Cardiovascular fitness is best improved by exercise types which employ large muscle groups. Such activities include cycling, running, swimming, rowing, skating, cross-country skiing and walking.

To monitor your fitness progress start with measuring your OwnIndex a couple times during the first two weeks, to get a baseline value. Thereafter, repeat the test approximately once a month. OwnIndex is based on resting heart rate, heart rate variability at rest, age, gender, height, body weight and self-assessed physical activity.



Predicted Maximum Heart Rate (HR_{max-p})

The HR_{max-p} definition is carried out simultaneously with the Polar Fitness Test.

The HR_{max-p} score predicts your individual maximum heart rate value more accurately than the age-based formula ($220-age$). The age-based method provides a rough estimation and may not be very accurate, especially for people who have been fit for many years or for older people. The most accurate way of determining your individual maximum heart rate is to have it clinically measured (in maximal treadmill or bicycle stress test) by a cardiologist or an exercise physiologist.

Your maximum heart rate changes to some extent in relation to your fitness. Regular endurance exercise tends to decrease HR_{max} . There may also be some variation according to the sport you participate in. For example, running $HR_{max} >$ cycling $HR_{max} >$ swimming HR_{max} .

HR_{max-p} gives the possibility of defining training intensities as percentages of maximum heart rate and of following maximum heart rate changes due to training, without an exhaustive maximal stress test. HR_{max-p} is based on resting heart rate, heart rate variability at rest, age, gender, height, body weight and maximal oxygen uptake, VO_{2max} (measured or predicted). The most accurate HR_{max-p} is obtained by entering your clinically measured VO_{2max} into the wrist receiver.





Fitness Test Settings

To be able to carry out the Polar Fitness Test you need to input the following settings in the Options mode:

- Set your personal user information and long-term physical activity level.
- Set the Polar Fitness Test on.
- Set the HR_{max-p} on if you want to get a prediction of your maximum heart rate.

Carrying Out the Test

To get reliable test results, the following basic requirements apply:

- You should be relaxed and calm.
- The test can take place anywhere – home, office, health club – as long as the testing environment is peaceful. No disturbing noises (Ex. television, radio or telephone), no other people talking to you.
- Keep the testing place, time of day and environment the same every time the test is repeated.
- Avoid eating a heavy meal or smoking 2-3 hours prior to testing.
- Avoid heavy physical effort, alcoholic beverages or pharmacological stimulants on the test day and the day before.

F 68

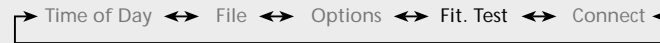

1. In the Time of Day display scroll up or down until FIT. TEST is displayed. If you cannot find Fitness Test mode check that you have turned the function on in the Options mode.
2. Press OK to enter the Fitness Test mode. Your latest OwnIndex and the testing date are displayed.
3. Scroll up or down to see your latest HR_{max-p} and the testing date.
4. **Lie down and relax** yourself for 1-3 minutes before the test.

Start the Test

It takes 3-5 minutes to carry out the test.

5. Press OK to start the test. The wrist receiver starts searching for your heart rate. TEST On and your heart rate are displayed. The test begins.
6. Lie relaxed. Keep your hands beside your body and avoid body movements. Don't communicate with other people.
7. Your current OwnIndex and the testing date are displayed.
8. If HR_{max-p} is on: Scroll up or down to see the HR_{max-p} result and the testing date.

Turn the Fitness Test Sound Signal on/off

The sound signal will alarm you at the end of the test. If the sound signal is on  appears on the display.

- To turn the sound signal on or off either before or during the test, press and hold the signal/light button.

F 69





Interrupt the Test

- You can stop the test any time during the test by pressing the stop button. Failed TEST is displayed for a few seconds. The latest OwnIndex and HR_{max-p} are not replaced.

If the wrist receiver does not succeed in receiving your heart rate at the beginning or during the test, the test will fail. Check that the transmitter electrodes are wet and the elastic strap is snug enough.

Update OwnIndex and HR_{max-p}

You can update your OwnIndex and HR_{max-p} values to the Options mode/ User information. When you update these values regularly, the reading in percentages of your maximum heart rate and calorie calculation give more accurate individual information.

- In the Time of Day display scroll up or down until FIT. TEST is displayed.
- Press OK to enter the Fitness Test mode.
- Scroll up or down until Update USER SET is displayed. This display appears if you have not updated your latest test results.
- Press OK to update the OwnIndex and HR_{max-p} values.
- To return to the Time of Day display, press and hold the stop button.

! Your maximum heart rate value is updated if the HR_{max-p} is on.

F 70



Fitness Classes

The Polar Fitness Test result, your OwnIndex, is most meaningful when comparing your individual values and changes in them. OwnIndex can also be interpreted according to your gender and age. Locate your OwnIndex on the table to find your current cardiovascular fitness classification, compared with those who are of the same age and gender.

	Age (years)	1 (very poor)	2 (poor)	3 (fair)	4 (average)	5 (good)	6 (very good)	7 (excellent)
MEN	20-24	< 32	32-37	38-43	44-50	51-56	57-62	>62
	25-29	< 31	31-35	36-42	43-48	49-53	54-59	>59
	30-34	< 29	29-34	35-40	41-45	46-51	52-56	>56
	35-39	< 28	28-32	33-38	39-43	44-48	49-54	>54
	40-44	< 26	26-31	32-35	36-41	42-46	47-51	>51
	45-49	< 25	25-29	30-34	35-39	40-43	44-48	>48
	50-54	< 24	24-27	28-32	33-36	37-41	42-46	>46
	55-59	< 22	22-26	27-30	31-34	35-39	40-43	>43
60-65	< 21	21-24	25-28	29-32	33-36	37-40	>40	
WOMEN	20-24	< 27	27-31	32-36	37-41	42-46	47-51	>51
	25-29	< 26	26-30	31-35	36-40	41-44	45-49	>49
	30-34	< 25	25-29	30-33	34-37	38-42	43-46	>46
	35-39	< 24	24-27	28-31	32-35	36-40	41-44	>44
	40-44	< 22	22-25	26-29	30-33	34-37	38-41	>41
	45-49	< 21	21-23	24-27	28-31	32-35	36-38	>38
	50-54	< 19	19-22	23-25	26-29	30-32	33-36	>36
	55-59	< 18	18-20	21-23	24-27	28-30	31-33	>33
60-65	< 16	16-18	19-21	22-24	25-27	28-30	>30	

The classification is based on literature review of 62 studies where VO_{2max} was measured directly in healthy adult subjects in the USA, Canada and 7 European countries. Reference: Shvartz E, Reibold RC. Aerobic fitness norms for males and females aged 6 to 75 years: a review. Aviat Space Environ Med; 61:3-11, 1990.

F 71





For various fitness classes we recommend the following:

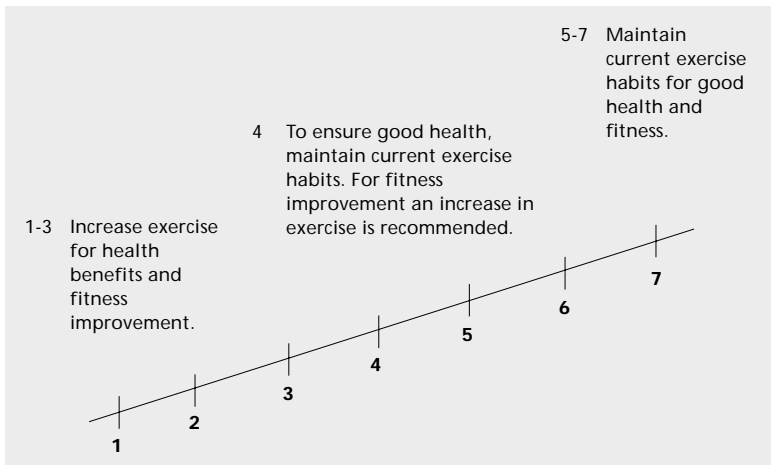

Top athletes typically score OwnIndex values above 70 (men) and 60 (women). Values as high as 95 can be reached by athletes of Olympic caliber. OwnIndex is highest in sports that involve large muscle groups such as cross-country skiing and cycling.



G. CARE AND MAINTENANCE



Your Polar heart rate monitor is a high-tech instrument of superior design and workmanship and should be treated with care. The suggestions below will help you fulfill the guarantee obligations and enjoy this product for many years to come.

Taking Care of Your Polar Heart Rate Monitor

- Wash the transmitter regularly after use with a mild soap and water solution. Dry it carefully after washing with soft towel.
- Never store the transmitter wet. Sweat and moisture can keep its electrodes wet and the transmitter activated, which shortens the battery life.
- Store your Polar heart rate monitor in a cool and dry place. Do not store it in any kind of non-breathing material, such as a plastic bag or a sports bag if it is wet.
- Do not bend or stretch the transmitter. This may damage the electrodes.
- Do not dry the transmitter in any other way than with a towel. Mishandling may damage the electrodes.
- Keep your Polar heart rate monitor out of extreme cold and heat. The operating temperature is 14 °F to 122 °F / -10 °C to 50 °C
- Do not expose the Polar heart rate monitor to direct sunlight for extended periods, such as by leaving it in a car.





Batteries

Transmitter

The estimated average battery life of the transmitter is 2500 hours of use. Contact your authorized Polar Service Center for a replacement transmitter. Polar recycles used transmitters. See your Customer Care Charter for detailed instructions.

Wrist Receiver

The estimated average battery life of the wrist receiver is 2 years in normal use (2h/ day, 7 days a week). Please note that excessive use of the backlight and the alarm signals will drain the battery more rapidly. Do not open the Polar wrist receiver yourself. To ensure the water resistance properties and the use of qualified components, the wrist receiver battery should be replaced by an authorized Polar Service Center only. At the same time a full periodic check of the Polar heart rate monitor will be done.

Service

Should your Polar heart rate monitor need service, see the Customer Care Charter to contact an authorized Polar Service Center.

! Water resistance cannot be guaranteed after unauthorized service.



74-75

H. PRECAUTIONS



Using the Polar Heart Rate Monitor in a Water Environment

Your Polar heart rate monitor is water resistant to 160 feet/ 50 meters.

Users measuring heart rate in a water environment may experience interference for the following reasons:

- Pool water with a high chlorine content and seawater are very conductive. The electrodes of a Polar transmitter may become short circuited which prevents EKG signals from detection by the transmitter unit.
- Jumping into the water or strenuous muscle movement during competitive swimming may cause water resistance that shifts the transmitter on the body to a location where it is not possible to pick up EKG signal.
- The EKG signal strength varies depending on the individual's tissue composition and the percentage of people who have problems in heart rate measuring is considerably higher in a water environment than in other use.

29.7.2002, 14:15

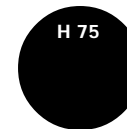



Polar Heart Rate Monitor and Interference

Electromagnetic Interference

Disturbances may occur near high voltage power lines, traffic lights, overhead lines of electric railways, electric bus lines/ trams, televisions, car motors, bike computers, some motor driven exercise equipment, cellular phones or when you walk through electric security gates.

Crosstalk

The Polar wrist receiver in non-coded mode (mode is indicated by heart symbol without frames) of operation picks up transmitter signals within 3 feet/ 1 meter. Non-coded signals, from more than one transmitter picked up simultaneously, can cause an incorrect readout.

Exercise Equipment

Several pieces of exercise equipment with electronic or electrical components such as LED displays, motors and electrical brakes may cause interfering stray signals. To try to tackle these problems, relocate the Polar wrist receiver as follows:

1. Remove the transmitter from your chest and use the exercise equipment as you would normally.
2. Move the wrist receiver around until you find an area in which it displays no stray reading or flashing of the heart symbol. Interference is often worst right in front of the display panel of the equipment, while the left or right side of the display is relatively free of disturbance.
3. Put the transmitter back on the chest and keep the wrist receiver in this interference-free area as far as it is possible.

H 76

S8

GBR A.pm6

76-77



4. If the Polar heart rate monitor still does not work with the exercise equipment, this piece of equipment may be electrically too noisy for wireless heart rate measurement.

Minimizing Possible Risks in Exercising with a Heart Rate Monitor

Exercise may include some risk, especially for those who have been sedentary. Before starting a regular exercise program an individual is recommended to answer to the following questions for health status checking. If the answer is yes to any of the questions, we recommend to consult a doctor before starting an exercise program.

- Have you not exercised for the past 5 years?
- Do you have high blood pressure?
- Do you have high blood cholesterol?
- Do you have symptoms of any disease?
- Are you taking any blood pressure or heart medication?
- Do you have a history of breathing problems?
- Are you recovering from a serious illness or medical treatment?
- Do you use a pacemaker or another implanted electronic device?
- Do you smoke?
- Are you pregnant?

Note that in addition to exercise intensity, medications for heart, blood pressure, psyche, asthma, breathing etc. as well as some energy drinks, alcohol and nicotine, can affect heart rate.

H 77

29.7.2002, 14:15





It is important to be sensitive to your body's reactions during the exercise. If you feel unexpected pain or tiredness regarding your exercise intensity level, it is recommended to stop the exercise or continue at a lighter intensity.

Notice to persons with pacemakers, defibrillator or other implanted electronic device. Persons who have a pacemaker use the Polar heart rate monitor at their own risk. Before starting use, we always recommend an exercise test under doctor's supervision. The test is to ensure the safety and reliability of the simultaneous use of the pacemaker and the heart rate monitor.

If you are allergic to any substance that comes into contact with the skin or if you suspect an allergic reaction due to using the product, check the listed materials in the "Technical Specifications" chapter. To avoid any skin reaction risk with the transmitter, wear it over a shirt. However, moisten the shirt well under the electrodes to ensure flawless operation.

! The combined impact of moisture and intense abrasion may cause a black color, which might stain light-colored clothes especially, to come off the transmitter's surface.

H 78

S8

GBR A_pm6

78-79



I. FREQUENTLY ASKED QUESTIONS



What should I do if...

...I don't know where I am in the Options or File cycle?

Press and hold the stop button until time of day is displayed.

...I cannot find the previous exercise's file?

You may have used the Measure mode during your exercise, which means that your exercise was not stored. To record the exercise you have to turn the stopwatch on by pressing the OK button in the Measure mode.

...I cannot find the expended calories from my exercise file?

Check that you have set your personal user information and turned the OwnCal function on. Check that your heart rate has reached over 90 bpm or above 60 % of your maximum heart rate during your exercise.

...I cannot turn my HR_{max}-p on?

Check that you have set your personal user information and turned the fitness test on before turning the HR_{max}-p on.

I 79

29.7.2002, 14:15





...there is no heart rate reading (- -)?

1. Check that the electrodes of the transmitter are moistened and that you are wearing it as instructed.
2. Check that you have kept the transmitter clean.
3. Check that you are not near other people that have heart rate monitors, high voltage power lines, televisions, mobile phones or other sources of electromagnetic disturbance.
4. Have you had a cardiac event which may have altered your EKG waveform? In this case consult your physician.

...the code search was not successful?

The frame around the heart symbol will disappear. Bring the receiver up to your chest near the transmitter's Polar logo. The receiver starts looking for a heart rate signal again. If you still do not succeed in code searching, but your heart rate is displayed and the heart symbol without a frame is flashing, you can start exercising. However, your wrist receiver may become disturbed by other heart rate monitors.

...heart symbol flashes irregularly?

1. Check that the wrist receiver is not further than 3 feet/ 1 meter from the transmitter.
2. Check that the elastic strap has not become loose during exercise.
3. Make sure that the electrodes of the transmitter are moistened.
4. Make sure that there is no other heart rate transmitter within 3 feet/ 1 meter.
5. Cardiac arrhythmia may cause irregular readings. In this case consult your physician.



...other person with heart rate monitor is causing interference?

Keep a distance from your training partner and continue your training session normally.

Or

1. Take the transmitter off your chest for 30 seconds. Keep a distance from your training partner.
2. Put the transmitter back and bring the receiver up to your chest near the transmitter's Polar logo. The receiver starts looking for a heart rate signal again. Continue your training session normally.

...heart rate reading becomes erratic or extremely high?

You may have come within range of strong electromagnetic signals which cause erratic readings. Check your surroundings and move further away from the source of disturbance.

...the display is blank or fading?

If the display is blank, activate the wrist receiver by pressing the OK button twice, after which the Time of Day display appears. The first sign of a discharged battery is the battery symbol on the display. Also the digits fade when the backlight is used. Have the batteries checked.

...there are no reactions to any buttons?

Reset the Polar heart rate monitor. Resetting clears watch settings which will return to the default settings. User information and measuring units settings will be saved.

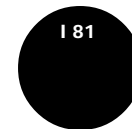
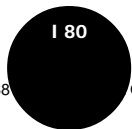



1. Press the RESET button with a pen tip. Display becomes full of digits. If you don't press any button after reset within one minute the wrist receiver goes to the Time of Day display.
2. Press any of the buttons once. The time of day is displayed.

...the battery of the wrist receiver must be replaced?

We recommend having all service done by an authorized Polar Service Center. This is especially necessary to ensure the guarantee remains valid and is not affected by incorrect repair procedures done by an unauthorized agent. Polar Service will test your wrist receiver for water resistance after battery replacement and make a full periodic check of the complete Polar heart rate monitor.

...the data transfer from receiver to computer was unsuccessful

1. Check the correct position of the wristwatch receiver with the infrared window of the computer or the optional Polar IR Interface.
2. Check that the surroundings are not too bright. This problem often occurs near windows.
3. Check that there is no obstruction between the infrared windows.



J. TECHNICAL SPECIFICATIONS

Polar heart rate monitor is designed to indicate the level of physiological strain and intensity in sports and exercise. No other use is intended or implied. Heart rate is displayed as number of heart beats per minute (bpm).

Transmitter

Battery type:	Built-in Lithium Cell
Battery life:	Average 2500 hours of use
Operating temperature:	14 °F to 122 °F/ -10 °C to +50 °C
Material:	Polyurethane
Waterproof	

Elastic Strap

Buckle material:	Polyurethane
Fabric material:	Nylon, polyester and natural rubber including a small amount of latex

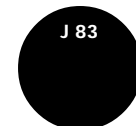

I 82

S8

GBR A.pm6

82-83

29.7.2002, 14:15





Wrist Receiver

Battery type: CR 2430
 Battery life: Average 2 years (2h/ day, 7 days/ week)
 Operating temperature: 14 °F to 122 °F/ -10 °C to +50 °C
 Water resistance: to 160 feet/ 50 meters
 Wrist strap material: Polyurethane
 Back cover and wrist strap buckle material: Stainless steel complying with EU Directive 94/27/EU and its amendment 1999/C 205/05 on the release of nickel from products intended to come into direct and prolonged contact with the skin.

Watch accuracy better than $\pm 0,5$ seconds/ day at 77 °F/ 25 °C temperature.
 Polar S810i is a Class 1 Laser Product.
 Accuracy of heart rate measurement: $\pm 1\%$ or ± 1 bpm, whichever larger, definition applies to steady state conditions.

Default Settings

In USA and Canada		Activity	Low
Time of Day	12 h	HR _{max}	220-age
In other countries		VO _{2max}	
Time of Day	24 h	male	45
Alarm	OFF	female	35
Date of Birth	0	Baseline	0
(adjustable range for year is 1921 - 2020)		Activity sound	On
Sex	Male	In USA and Canada	
Weight	0	Units	2
Height	0	In other countries	
		Units	1

J 84



Help	On
OwnCal	OFF
Fitness test	On
HR _{max} -p	OFF
Online	OFF
Exercise settings	
BasicUse	On
BasicSet function	OFF
Profile function	OFF
Heart touch function	Shows heart rate limits
Recording rate	5 s

Limit Values

Exercise time	99 h 59 min 59 s
Heart rate limits	30 - 240
Heart rate zone time	99 h 59 min 59 s
Recovery time	99 min 59 s
Calories	99 999 kcal
Cumulative calories	999 999 kcal
Cumulative exercise time	9 999 h
Laps recorded to memory	99
Files recorded to memory	99

J 85





K. LIMITED POLAR INTERNATIONAL GUARANTEE

- This limited Polar international guarantee is issued by Polar Electro Inc. for the consumers who have purchased this product in the USA or Canada. This limited Polar international guarantee is issued by Polar Electro Oy for the consumers who have purchased this product in other countries.
- Polar Electro Inc. / Polar Electro Oy guarantees to the original consumer/purchaser of this product that the product will be free from defects in material or workmanship for two years from the date of purchase.
- **Please keep the receipt or International Guarantee Card, which is your proof of purchase!**
- The guarantee does not cover the battery, damage due to misuse, abuse, accidents or non-compliance with the precautions; improper maintenance, commercial use, cracked or broken cases.
- Guarantee does not cover any damage/s, losses, costs or expenses, direct, indirect or incidental, consequential or special, arising out of, or related to the product. During the guarantee period the product will be either repaired or replaced at an authorized service center free of charge.
- This guarantee does not affect the consumer's statutory rights under applicable national or state laws in force, or the consumer's rights against the dealer arising from their sales/ purchase contract.

 This CE marking shows compliance of this product with Directive 93/42/EEC.

Copyright © 2000, 2002 Polar Electro Oy, FIN-90440 KEMPELE, Finland. All rights reserved.
No part of this manual may be used or reproduced in any form or by any means without prior written permission of Polar Electro Oy.
The names and logos marked with a TM symbol in this user's manual or in the package of this product are trademarks of Polar Electro Oy, except that Sound Blaster is a trademark of Creative Technology, Ltd. The names and logos marked with a ® symbol in this user's manual or in the package of this product are registered trademarks of Polar Electro Oy, except that Windows is a registered trademark of Microsoft Corporation.

K 86

S8

GBR A.pm6

86-87



L. DISCLAIMER

- The material in this manual is for informational purposes only. The products it describes are subject to change without prior notice, due to the manufacturer's continuous development program.
- Polar Electro Inc. / Polar Electro Oy makes no representations or warranties with respect to this manual or with respect to the products described herein. Polar Electro Inc. / Polar Electro Oy shall not be liable for any damages, losses, costs or expenses, direct, indirect or incidental, consequential or special, arising out of, or related to the use of this material or the products described herein.

This product is protected by one or several of the following patents:
FI 88223, DE 4215549, FR 92.06120, GB 2257523, HK 113/1996,
SG 9591671-4, US 5491474, FI 88972, DE 9219139.8, FR 92.09150,
GB 2258587, HK 306/1996, SG 9592117-7, US 5486818, FI 96380, US 5611346,
EP 665947, DE69414362, FI 68734, DE 3439238, GB 2149514, HK 812/1989,
US 4625733, FI 100924, FI 100452, US 5840039, FI 4150, DE 20008882.3,
FR 0006504, FI 4069, US 6272365, FR 9907823, GB 2339833, DE 29910633,
FI 104463, US 6183422, FI 4157, DE 20008883.1, FR 0006778, WO 97/33512,
GB 2326240.
Other patents pending.

L 87

29.7.2002, 14:15





M. POLAR GLOSSARY

Activity level: A personal assessment of your long term physical activity level that is used in the Polar Fitness Test.

Coded heart rate transmission: Polar coded transmitter automatically locks in a code to transmit your heart rate to the wrist receiver. In a coded transmission the receiver accepts heart rate data only from the Polar coded transmitter. Coding significantly reduces crosstalk caused by other users of heart rate monitors. However, it does not necessarily reduce all environmental interference.

Electrodes: The grooved areas of the transmitter that rest against the skin and pick up the EKG signal.

Exercise mode: The stopwatch is on and your exercise is recorded. You can select either the BasicUse, Profiles and BasicSet exercise modes.



Heart touch function: When you are in Exercise mode, bring your wrist receiver close to the Polar logo on your transmitter and the selected heart touch function is activated for a few seconds.

Maximal oxygen uptake: (maximal aerobic power, VO_{2max}) Is the maximal rate at which oxygen can be used by the body during maximal work. VO_{2max} is a good index of aerobic fitness.

Maximum heart rate: (HR_{max}) Is the highest number of heart beats per minute of a person.

Measure mode: Measuring your heart rate without recording the exercise.

Target heart rate zone: The area between the upper and lower target heart rate limits. Target zone selection is based on personal fitness goals.



M 88

S8

GBR A_pm6

88-89

29.7.2002, 14:15

M 89





Display Symbols

- ♥ Indicates an ongoing heart rate measurement and flashes to the beat of your heart. A heart without frames indicates a non-coded heart rate transmission.
- ♥ Frame around the heart indicates a coded transmission of heart rate.
- ∞∞ Indicates there has not been heart rate reception for at least 5 seconds.
- - Indicates there is no heart rate reception. Bring the wrist receiver up to your chest near the transmitter's Polar logo. The receiver starts looking for the heart rate signal again.
-)) In the Time of Day display the alarm is on.
Measure mode: beeps if you are exercising outside your target heart rate zone. Fitness Test mode: sounds an alarm at the end of the fitness test.
- ▮▮▮ Indicates profile exercise.
- ▮▮▮▮▮ Indicates continuous intervals and recoveries. See Cont in "display texts" chapter.
- ▲ Exercise mode: indicates the heart rate above the target zone.
- ▼ Exercise mode: indicates the heart rate below the target zone.
- ▮▮▮▮▮ The graphic bar consists of five blocks. A flashing block indicates in which level you are in the Options settings or File recalling loops.
- ▮▮▮▮▮ Continuously running bars indicate that the exercise is recorded.
- ⇨ Indicates low battery.

M 90



Display Texts

- ALARM:** Indicates the alarm in watch settings.
- AM or PM:** Are used in 12h time mode. Ex. in 24h time mode 13:00 means 1:00 PM.
- AVG:** Together with a reading indicates average heart rate.
- Baseline:** Set your personal relaxation rate baseline.
- BasicSet:** Pre-programmable exercise with three alternating timers and heart rate limits. Additionally you can set a time- or heart-rate-based recovery function that is turned on manually in the exercise situation.
- BasicUse:** Exercising without settings.
- BestLap:** Indicates the shortest lap time information.
- CONNECT:** Communication mode between wrist receiver and computer.
- Cont:** Up to 30 intervals and recoveries succeed one another unless the phase is manually stopped.
- E0:** Indicates BasicUse exercise.
- E1-E7:** Indicates the profile exercise.
- E8:** Indicates the BasicSet exercise.
- EXE. SET:** Indicates the recorded exercise profile information in the File mode.
- Exe. Time:** Indicates the time you exercised with running stopwatch.
- FILE:** Indicates the file mode.
- FIT. TEST:** Indicates fitness test mode.
- FULL:** After having stored 99 laps (the use of Profiles reduces the amount) FULL appears in the display. You can continue taking lap times or Profiles but they won't be recorded into the file.
- HR_{max}-p:** Predicted maximum heart rate value.
- Int.:** Indicates the work period of a profile exercise.
- InZone/ Above/ Below:** Indicate the time spent within, above and below the target zone.
- KCal:** Indicates the energy expenditure of your exercise.

M 91





LAPS: Indicates how many lap times have been stored.

Lap Time, Lp: Indicates the time the lap took.

Lim High: The higher heart rate limit of the target zone.

Lim Low: The lower heart rate limit of the target zone.

Limits: Heart rate limits for target zones.

MAX: Indicates the highest heart rate.

MAX %: Indicates what percentage your current heart rate is of your maximum heart rate.

Mem full: Appears on the display when the memory is full. You can continue your exercise and taking lap times but they won't be recorded into the file.

MIN: Indicates minimum heart rate of exercise in the File mode.

ms: Millisecond

Online*: Online recording allows you to transfer your heart rate to computer in real time. Place the

wrist receiver within the reception range, 8" / 20 cm, of the interface and within range of the transmitter, 3 feet / 1 meter.

OPTIONS: Indicates the Options mode.

OwnCal: Calculates energy expenditure during exercise in kilocalories. 1 kilocalorie (kcal) = 1000 calories (cal). You can follow how much energy you lose by exercising in one exercise session or in a day, week or even a year. The OwnCal can be used as a dose measure of exercise Ex. in nutrition planning. OwnCal calorie calculation starts when your heart rate reaches 90 bpm or is above 60 % of your maximum heart rate, whichever is smaller. These limits are set to count only exercise calories. The higher the heart rate, the faster the energy expenditure. OwnCal is individually calibrated by your preset weight, maximal oxygen uptake (VO_{2max}) and maximum heart rate (HR_{max}). The

most accurate OwnCal is received by entering your clinically measured (in maximal treadmill or bicycle stress test) VO_{2max} and HR_{max} into the wrist receiver. Energy expenditure measurement is most accurate in continuous activities such as cycling and running.

OwnINDEX: Result of Polar Fitness Test and comparable score with maximal oxygen uptake (VO_{2max} in ml/kg/min).

P1-P6, exercise phases: Indicates pre-programmable exercise phases of the profile exercise. Each phase includes adjustable number of interval periods and a recovery period.

Profil: Indicates a preprogrammable exercise profile with six optional phases.

RecoHr, heart-rate-based recovery: You set the heart rate, which will end your recovery calculation. In the File mode you will see the drop in your heart rate and the recovery duration.



RecoTime, time-based recovery: You set the recovery time in the Options mode. In the File mode you will see the drop in your heart rate and the recovery duration.

Rlx, Relaxation rate: Relaxation rate is most useful when measuring your heart rate at rest or during light daily activities, such as office work. After exercise, Ex., in the following morning, the value can also indicate the state of your physical recovery. A resting heart rate significantly higher or a relaxation rate smaller than normal may be an indication of an incomplete recovery. Mental stress typically increases heart rate and decreases relaxation rate. Relaxation rate measurement is based on the heart rate variability, which indicates your autonomic nervous system's state. The degree of heart rate variability is highly individual and tends to decrease over time.

RR: R-R recording rate measures heart beat intervals, i.e. the time

*An optional IR Interface is required.

M 92

S8

GBR A.pm6

92-93



29.7.2002, 14:15

M 93





between successive heart beats in milliseconds. This information is also shown as instantaneous heart rate in beats per minute in recorded samples. Recording every interval accurately is more difficult than obtaining the averaged heart rate only, because R-R recording rate is shielded less from measurement disturbances. We recommend using contact gel (ECG gel) to ensure contact between your skin and the transmitter. It is useful to minimize the use of the heart touch function and backlight, because the heart rate receiver does not detect new

heart beat intervals when the backlight is on. Also the use of activity/button sound may occasionally cause a loss of one R-R interval. Readings that are interpreted as incorrect in the heart rate data can be adjusted and corrected with Polar Precision Performance software.

Split Time: The time exercised so far when you take a lap time during exercise.

Sw: Indicates stopwatch.

Tot. Time: Indicates cumulative exercise times of several exercise sessions.



Index

12h/ 24h time mode	36	HR _{max} -p On/OFF	33
Activity/button sound On/OFF	34	Illuminating the display	42
Alarm settings	36	Interrupt an exercise phase	51
Baseline for relaxation rate	19	Interrupt an interval or recovery calculation	51
BasicSet exercise	21, 49	Lap and split time storing	42, 51, 59
BasicUse exercise	20, 22	Measuring units settings	34, 38
Buttons	6	Modes and their functions	11
Care and maintenance	73	Name profiles	30
Code search	39, 80, 88	Online* measurement to computer	40, 64, 92
Connection to computer	62	Online* On/OFF	33
Date settings	37	Options lock function	62
Deleting a file	61	OwnCal calorie expenditure	44, 92
Display configuration	43	OwnCal On/OFF	32
Download training data to a computer	62	OwnIndex	65, 93
Easy start	8	Pause an exercise	43
Exercise settings	20	Precautions	75
File	52	Predicted maximum heart rate	67, 91
Fitness test	65	Profile exercise	46, 57, 93
Fitness test On/OFF	32	Recall training information	52
Frequently asked questions	79	Recording rate settings	31
Functions during the exercise	41	Records file	60
Guarantee	86	Recovery during BasicSet	50, 55
Heart rate limits	51, 55	Recovery during exercise profile ...	48, 58
Heart rate limits settings for BasicSet	23	Recovery settings for BasicSet	24
Heart rate limits settings for Profile ...	28	Recovery settings for exercise profile	29
Heart rate zone alarm On/OFF	41	Relaxation rate	19, 44, 93
Heart touch function	51	Reminder On/OFF	37
Help On/OFF	35	Reset the cumulative counts	60
How to enter settings	14		

* An optional Polar IR Interface is required.

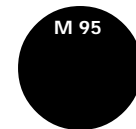
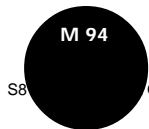



Reset the heart rate monitor 81
 Reset the stopwatch 45
 Return to the Time of Day display 7
 Selecting exercise type 20, 50
 Setting interval calculation 26
 Setting tips 38
 Start a profile exercise 46
 Start measuring your heart rate 9, 39
 Stop a profile exercise 49
 Stop measuring your heart rate 10, 50
 Swap the exercise type 50
 Swap the heart rate limits 49
 Swap the time zones 1/ 2 38
 Technical specifications 83
 Time of day settings 36
 Timer settings for BasicSet 23
 Transmitter 5, 10
 Update HR_{max}-p and OwnIndex
 to user information 70
 Upload settings from computer 63
 User information settings 16

