

TOSHIBA



**TOSHIBA AMERICA INFORMATION SYSTEMS
STORAGE DEVICE DIVISION
IRVINE, CALIFORNIA**

**SD-R1312
CD-RW/DVD-ROM COMBO DRIVE
USER MANUAL**

CONTENTS

Introduction.....	1
Setup	3
Using the Combo Drive	6
Troubleshooting.....	9
Specifications	10
Drive Connectors.....	13

INTRODUCTION – SD-R1312

General Features

Reads and records digital data on CD-R/-RW discs at 32X/10X

3-way Disc Eject (eject button, software, emergency eject hole)

Average Random Access Time

CD	110ms
DVD-ROM	130ms
DVD-RAM	170ms

Horizontal or Vertical Mount

2MByte Buffer

Playback interchangeability for CD-ROM and DVD-ROM discs

Regionalization (RPC2 compliance) (DVD)

BUS Interface - ATAPI

Types of Disc Formats Supported - Write

- Applicable Write Format CD-R, CD-RW: Disc at once, Track at once, Session at once, Packet write
- Applicable Write disc CD-R/-RW: CD-DA, CD+(E)G, CD-MIDI, CD-TEXT, CD-ROM, CD-ROM XA, MIXED MODE CD, CD-I, CD-I Bridge, (Photo-CD, Video-CD), Multi-session CD (Photo-CD, CD EXTRA, Portfolio, CD-R/RW), CD-R/RW

Types of Disc Formats Supported - Read

DVD:

DVD-ROM (DVD-5, DVD-9, DVD-10, DVD-18), DVD-R (Ver 1.0, Ver 2.0 – Read, Single border), DVD-RW (Read Ver 1.1), DVD-RAM (Ver 2.1)

CD:

CD-DA, CD+(E)G, CD-MIDI, CD-TEXT, CD-ROM, CD-ROM XA, CD-I, CD-I Bridge (Photo-CD, Video-CD), Multi-session (Photo-CD, CD-EXTRA, CD-R, CD-RW, Portfolio), CD-R, CD-RW

Front Panel

Figure 1. SD-R1312 DVD Writeable Drive Front Panel

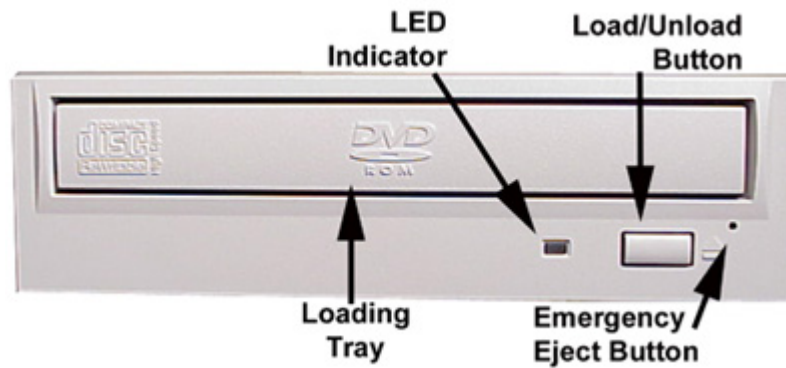

Loading Tray	Load disc using tray.
Busy Light LED	The LED lights green or amber when the drive is operating (LED is amber when drive is writing.)
Eject Button	The Eject button is used to open the disc tray so you can install or remove a disc.
Emergency Eject Hole	The emergency eject hole is to be used only when the Loading Tray will not open when Eject button is pressed.

SETUP – SD-R1312

The following steps must be performed to properly install your drive:

- Set Drive Jumper Settings
- Connect Audio Cable
- Attach IDE BUS Cable
- Attach Power Cable
- Mount Drive

Jumper Settings

The mode select jumpers are 6 straight angle pins located on the rear of the Combo drive. By placing a jumper on the pins, you can select the following functions:

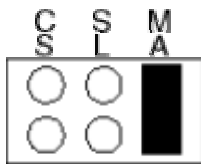

- CS Drive is configured using host interface signal CSEL
- SL Configures drive as Slave
- MA Configures drive as Master (default mode)

Figure 1.Mode Select Jumper

In most installations, jumper should remain in the MA position (factory default). It is recommended that you install your Combo drive only on the secondary IDE BUS. If you are installing on primary IDE BUS, your hard drive would then be the Master, and you should set your Combo drive to the Slave position (SL)

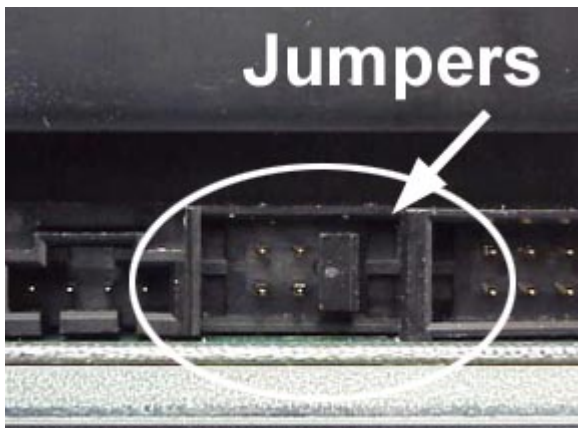



Figure 2.Jumper Locations

Placing Combo Drive inside your Computer

Now that you have set the jumpers, you are ready to install your Combo drive inside your computer.

 **Important Note: Disconnect power from your computer system before beginning installation.**

Remove computer cover and faceplate if required. Refer to your computer systems manual for removal information. If the Combo drive is replacing a CD-ROM or DVD-ROM, remove drive presently installed in your system.

Your Toshiba Combo drive can be placed in any free half-height drive slot at the front of your computer. (It can be mounted horizontally or vertically.)

Carefully start sliding the Combo drive into the opening with the disc tray facing the front of the computer. Before you push the drive all the way in you will need to connect the IDE BUS cable, Audio cable and the Power cable on the back of the drive.

Connecting Cables

IDE BUS Cable (not supplied with drive) - Your computer system should have a primary and secondary IDE BUS, cable with your Hard Drive most likely being the Master on the primary BUS. Connect BUS cable as follows, assuring that pin 1 of cable (side with red stripe) is connected to pin 1 of the Combo drive's interface connector:

If you are replacing your CD-ROM or DVD:
connect Combo drive to the BUS Cable connector that the CD-ROM or DVD was connected to.

If Combo drive is not replacing a CD-ROM/DVD or is an addition to a CD-ROM/DVD:
connect Combo drive to an open connector on the secondary IDE BUS cable (not supplied with drive).

If Combo drive is to be slave on Primary BUS:
connect Combo drive to open connector on the primary IDE BUS cable (not supplied with drive).



Figure 3. Installing BUS Cable

Power Cable - Connect an internal computer power supply cable to the power socket at the back of the Combo drive. One side of the plug has chamfered edges, so the power connector fits only one way. Push plug completely into the socket making sure the plug fits correctly.



Figure 4. Installing Power Cable

Audio Cable (optional) - If you have a sound card and speakers, and would like to play audio CDs on your computer, you will need to install a CD/DVD audio cable. Toshiba's Combo drives use a standard 4-pin audio cable that can be purchased from most local computer suppliers. The sound cable connects to your sound card at one end and the other end connects to the digital audio connector at the left rear of the Combo drive (see Combo drive Back Panel photo for location). Refer to the instructions that came with your sound card for details on any sound-driver software required.

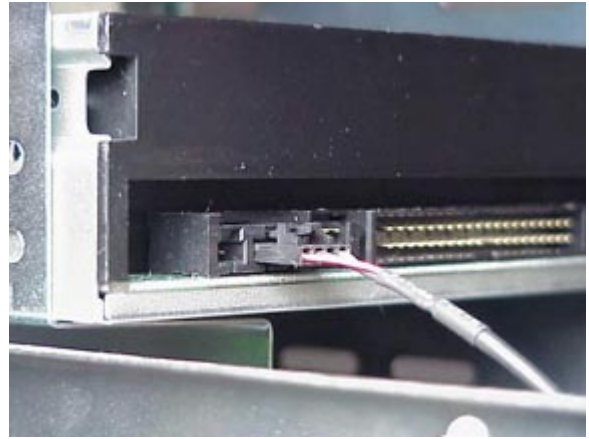

Figure 5. Installing Audio Cable

Completing Installation

After you have connected all the necessary cables, push the Combo drive completely into the computers drive slot. Mount drive per your computers instructions. The screw length should not exceed 30.5mm (measured from outside surface of side or bottom of drive to tip of screw). Replace computer cover and all outer screws.

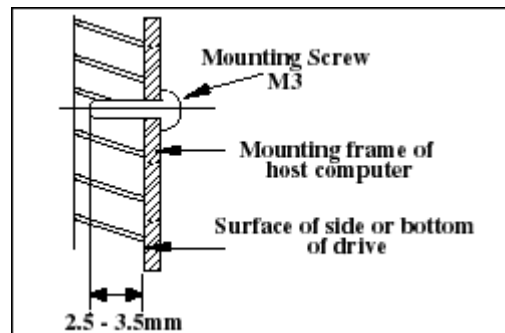

Figure 6. Mounting Illustration

Software Driver - Toshiba's optical drives do not require any unique device drivers for Windows '95/'98/2000/Me/XP/NT. After installing your drive and re-booting, your system should recognize your drive. Windows '95/'98/2000/Me/XP/NT Operating Systems support all Toshiba optical drives natively. If you prefer using DOS, download the DOS ATAPI driver from our web site.

Other Software - Additional software is required to use the SD-R1312 CD-R/-RW and DVD functions. When you purchase the SD-R1312 as a kit, it will include the following software (Nero6):

- VOB InstantCD/DVD Software - used to create CDs
- CyberLink PowerDVD - used to view DVDs

USING THE DVD Combo Drive – SD-R1312

Drive Operation

Inserting a Disc - Horizontally

To insert a disc into a drive that is mounted horizontally, perform the following steps:

Figure 1. Inserting Disc



1. Open the drive's Loading tray by pressing the Eject Button.
2. Place disc or into drive's Loading tray
3. Press Eject button again or gently push on the open disc tray. Tray will automatically close.

Inserting a Disc - Vertically

To insert a disc in a drive that is mounted vertically, perform the following steps:

1. Locate sliding disc holders (4 locations) on drive's Loading Tray.
2. The vertical position of the drive (eject button up or down) determines which of these four sliding disc holders are used (see photo below). Position the disc behind 3 of the disc holders, two on bottom, and one on upper rear, closest to drive). Using all four holders may cause the disc to not set properly in tray.
3. Slide the disc holders towards the center of tray using your finger, opened paper clip or the end of the emergency eject tool. The holder in the upper front side should be pulled away from the center of tray.
4. Position the disc behind disc holders on upper and rear side of tray. Then put disc behind bottom front holder
5. Check to see that all three disc holders are holding disc securely.
6. Close the drive by gently pushing in the tray or pressing the eject button.

Figure 2. Inserting Disc Vertically



Removing a Disc

To remove a disc from the Combo drive, perform the following steps:

1. Open the Loading Tray by pressing the Eject Button.
2. Slide disc holders away from disc.
3. Grasp disc by edges, and lift out of loading tray.
4. Press Eject Button again to close Loading Tray.

Software

When you purchase the SD-R1312 as a Kit, it will include Nero6 OEM Suite Software, which is used to create CDs and view DVDs.

Usage Guidelines

- Keep the disc tray closed when not using the Combo Drive.
- Do not press down on the disc tray when opening or closing it.
- Do not place objects on the disc tray.
- Never use a damaged, broken, or deformed disc.
- Do not press the Open/Close button while the drive is playing a DVD movie or accessing a disc. To stop a DVD movie, click Stop button in the DVD player application program.



NOTE: High-speed drives spin the disc at a high rotational speed. If a disc has printing on only half of the disc, or if there is a slight imbalance in the disc, the imbalance is greatly magnified by the high speed, causing the drive to vibrate or produce a fan-like noise. These effects are inherent in the high-speed technology and do not indicate a problem with the drive.

Emergency Ejection



CAUTION: The following procedure is intended only as a last resort when pressing the eject button fails to open the Loading Tray

1. Turn computer power OFF by properly shutting down system.
2. Insert a solid bar (i.e. large paper clip) into Emergency Eject hole and push in until loading tray opens. Pull tray out.

Figure 3.Using Emergency Eject



Handling Media

DVD media is sensitive to dust and fingerprints. Carefully handle media by its edges only. If a DVD movie skips or hangs during playback, clean the media. Most DVD video playback issues are media-related and can be remedied by proper handling and care of media.

Cleaning Media

Try to avoid touching the read area (underside) of the disc as dirt and smears will degrade the disc accessing speed.

If the disc becomes dirty wipe it with a damp soft cloth. Avoid cleaning in a circular motion, but rather from the inner side outward.

TROUBLESHOOTING – SD-R1312

Problem	Solution
Disc tray cannot be opened	<ul style="list-style-type: none"> • Check that there is power to drive. • Use Emergency Eject instructions to open tray.
Drive is not recognized by system	<ul style="list-style-type: none"> • Is the drive connected properly? Are all cables plugged in properly (e.g. Power Cable, Interface Cable and Audio Cables). • Are the drive configuration jumpers on the Combo drive set properly? • Is the software driver loaded? On a step-by-step (F8) Boot of the system is the Combo drive recognized? (BIOS / DOS reports "device driver not found" or "no valid drivers selected."). If not, Contact Technical Support. • Has the Combo drive software driver been corrupted by a virus. Run a Virus Scan program and repair if possible. Contact Technical Support if the Virus renders the Combo drive software drivers not useable.
Drive is not recognized by system during Boot process, but is recognized by the Operating System (i.e. XP, Win2000, Win98, Win NT, etc.)	<ul style="list-style-type: none"> • Is the Combo drive software driver loaded? On a step-by-step (F8) Boot of the system is the Combo drive recognized? (BIOS / DOS reports "device driver not found or no valid DVD drivers selected."). If not, Contact Technical Support. • Has the Windows Combo drive software driver program been corrupted by a virus. Run a Virus Scan program and repair if possible. Contact Technical Support if the Virus renders the software drivers not useable.
BUSY Indicator LED flashes slowly	<ul style="list-style-type: none"> • The disc may be dirty Clean it with a soft damp cloth. Avoid cleaning the disc using a circular motion. The disc should be wiped in a radial direction. That is, from the inner side outward. • The laser lens may have become cloudy or blocked by particulate matter. Please contact Technical Support.
BUSY Indicator LED is constantly ON	<ul style="list-style-type: none"> • Possible Hardware Problem. Please contact Technical Support.
DVD-ROM can not play a DVD in the drive or certain types of CD media (i.e. CD-plus, etc.)	<ul style="list-style-type: none"> • Is the Combo drive driver loaded • Is the DVD disc the correct format for the type of system that you are using? (i.e. on a PC an ISO9660 IBM compatible PC format as opposed to Apple/Mac HFS disc or UNIX disc formats which will not function). • Do you have the correct software applications program/drivers installed to run a DVD disc? • Has the Windows Combo drive software driver program been corrupted by a virus. Run a Virus Scan program and repair if possible. Contact Technical Support if the Virus renders the software drivers not useable.

SPECIFICATIONS – SD-R1312

General

Interface:	ATAPI
Applicable Formats - Write:	
Formats for Writing	Disc at once, Track at once, session at once, Packet Write, incremental write, restricted overwrite
Applicable Write Disc – CD-R/-RW	CD-DA, CD+(E)G, CD-MIDI, CD-ROM, CD-ROM XA, CD-I, MIXED MODE CD, CD-I Bridge (Photo-CD, Video-CD), Multi-session CD (Photo-CD, CD-Extra, Portfolio)
Applicable Formats - Read:	
DVD	DVD-ROM (DVD-5, DVD-9, DVD-10, DVD-18) DVD-R (Ver. 1.0, Ver 2.0), DVD-RW (Ver. 1.1), DVD-RAM (read, Ver 2.1)
CD:	CD-DA, CD+(E)G, CD-MIDI, CD-TEXT, CD-ROM, CD-ROM XA, CD-I, CD-I Bridge (Photo-CD, Video-CD), Multi-session (Photo CD, CD-Extra, CD-R, CD-RW, Portfolio), CD-RW, CD-R



Note: All DVD/CD formats, except CD-Red Book (audio), require additional application specific software and/or hardware. The drive is capable of reading these data formats. However, in order to run applications that use these formats, you must first have the required software and/or hardware.

Data Disc Capacities

DVD-ROM	4.377GB (DVD-5) 7.959GB (DVD-9) 8.754GB (DVD-10) 15.917GB (DVD-18)
DVD-R (Ver 1)	3.679GB
DVD-R (Ver 2.0), DVD-RW	4.377GB
CD	656.5MB (mode 1) 748.8MB (mode 2)

Performance

Rotational Speed

DVD-ROM (single layer)	7,580rpm (5.0 - 12X CAV)
DVD-ROM (dual layer)	5,053rpm (3.3 - 8X CAV)
DVD-R (Ver. 2.0)	2,780rpm (2 - 4.8X CAV)
DVD-R (Ver. 1.0)	3,200rpm (2 - 4.8X CAV)
DVD-RW (Ver 1.1)	2,780rpm (2 - 4.8X CAV)
DVD-RAM (Ver. 2.1)	2,160 – 4,800rpm (2X ZCLV)
DVD-video (CSS-Disc)	2,780rpm (2 - 4.8X CAV)
CD-ROM, CD-R	8,561rpm (13.8 - 40X CAV)
CD-RW	4,281rpm (8.6 - 20X CAV)
CD-DA Transfer	3,200rpm (12.7 - 16X CAV)
CD-DA, Video-CD	1,200 – 2,000rpm (4 - 6X PCAV)

CD-R (Write)	5,940 – 6,800rpm (12/16/20/24/32X ZCLV) 5,100 – 5,940rpm (12/15/20/24X ZCLV) 2,550 – 5,940rpm (12X CLV) 850 – 1,980rpm (4X CLV)
High Speed CD-RW (Write)	2,125 – 4,950rpm (10X CLV) 850 – 1,980rpm (4X CLV)
CD-RW (Write)	850 – 1,980rpm (4X CLV)

Transfer Rate

DVD (Single)	6,682 – 16,200KB/second
DVD (Dual)	4,432 – 10,800KB/second
DVD-VIDEO (CSS Disc)	2,704 – 6,536KB/second
DVD-R, DVD-RW	2,704 – 6,536KB/second
DVD-RAM	2,704KB/second
CD	2,588 – 6,000KB/second (mode 1) 2,950 – 6,843KB/second (mode 2)
CD-RW	1,294 - 3,000KB/second (mode 1) 1,475 – 3,422KB/second (mode 2)

Random Access Time

DVD	130ms
CD	110ms
DVD-RAM	170ms

Data Error Rate

DVD-ROM	10 ⁻¹⁵ Max
CD-ROM	10 ⁻¹⁵ Max (Mode 1) 10 ⁻¹² Max (Mode 2)

Data Buffer

2MB

Reliability

MTBF	100,000 hours
Power ON Hours	5,436 hours/year
ON/OFF Cycles	313 cycles/year
Number of Access	600,000 accesses/year
Operating Duty Cycle	20% of Power ON time (Reading/Seeking) 2% of Power ON time (Writing/Seeking)
MTTR	0.5 hours

Environmental

Ambient Temperature

Operating	5° to 50° C (41° to 122° F)
Storage	-10° to 60° C (14° to 140° F)
Shipping	-40° to 65° C (-40° to 149° F)

Temperature Gradient

Operating	11° C /hour (max)
Storage/Shipping	20° C /hour (max)

Relative Humidity	
Operating	8% to 80%
Storage/Shipping	5% to 95% (wet bulb 40° C max)

Vibration	
Operating (5 to 500 Hz) (read)	2.45 m/s ² (0.25G) (O-P)
Operating (5 to 500Hz) (write)	2.45 m/s ² (0.25G) (O-P)
Non-operating (10 to 500Hz)	9.8 m/s ² (1.0G) (O-P)
Transporting (with packing) (10 to 25 Hz)	9.8 m/s ² (1.0G) (O-P)

Shock (Non-operating) 490 m/s² [50G]

Acoustical Noise 40dB

Power

DC Voltage and Current Requirements 5V, 12V ±5%

Physical

Height	5.75" (146mm)
Width	1.63" (41.5mm)
Depth	7.60" (193mm)
Weight	2.42lbs (1.1kg)

Connectors

DC input 4-pin Power Supply Connector

ATAPI Interface Connector 40 Pin I/F ATAPI Standard

Audio Connectors 4-pin and 2-pin connector (use matching housing, Part No. 70066, made by Molex Corp, or equivalent)

Regulatory

The SD-R1312 Combo drive has been certified by the following regulatory agencies:

- UL 1950
- CSA C22.2 No. 950
- TUV (EN60950I)
- CE standard
- DHHS 21 CFR Sub-Chapter J
- FDA CFR21, EN60825

DRIVE CONNECTORS – SD-R1312

Figure 1. SD-R1312 Combo Drive Rear Panel - Connectors

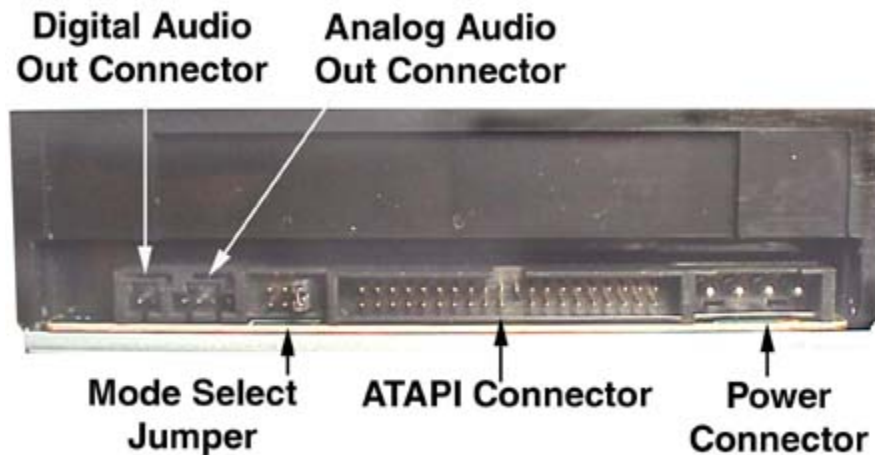

Power Connector Power is supplied to your DVD drive by the connection with your computer's +5V/+12V power cable to the power socket at the back of drive. One side of the plug has chamfered edges, so the power connector fits only one way



CAUTION: Severe damage to the Drive circuits may occur if power cable is plugged in upside-down with power ON

Audio Connectors Supplies Analog and Digital sound to your system.

ATAPI Connector The SD-R1312 DVD drive is connected to your computer system through the ATAPI connector

Mode Select Jumper The mode select jumpers are 6 straight angle pins located on the rear of the DVD drive. By placing a jumper on the pins, you can select the following functions: CL (CSEL), SL (Slave) or MA (Master). (see Setup for additional information).

Table 1.Interface Pin Assignments

INTERFACE PIN ASSIGNMENT							
PIN NO.	I/O	SIGNAL NAME	HOST SIGNAL NAME	PIN NO.	I/O	SIGNAL NAME	HOST SIGNAL NAME
1	I	Reset	Host Reset	21	O	HDRQ	DMA Request
2	-	GND		22	-	GND	
3	I/O	HD7	Host Data Bus BIT 7	23	I	HWR-,STOP	Host I/O Write
4	I/O	HD8	Host Data Bus BIT 8	24	-	GND	
5	I/O	HD6	Host Data Bus BIT 6	25	I	HRD-, HDMARDY, - HSTROBE	Host I/O Read
6	I/O	HD9	Host Data Bus BIT 9	26	-	GND	
7	I/O	HD5	Host Data Bus BIT 5	27	O	IORDY, DDMARDY,- DSTROBE	I/O Channel Ready
8	I/O	HD10	Host Data Bus Bit 10	28	-	CSEL	Cable Select
9	I/O	HD4	Host Data Bus BIT 4	29	I	HDAK-	DMA Acknowledge
10	I/O	HD11	Host Data Bus BIT 11	30	-	GND	
11	I/O	HD3	Host Data Bus BIT 3	31	O	INTRQ	Host Interrupt Request
12	I/O	HD12	Host Data Bus BIT 12	32	O	IOCS16-	Host 16 BIT I/O
13	I/O	HD2	Host Data Bus BIT 2	33	I	HA1	Host Address Bus BIT 1
14	I/O	HD13	Host Data Bus BIT 13	34	I/O	PDIAG-	Passed Diagnostics
15	I/O	HD1	Host Data Bus BIT 1	35	I	HA0	Host Address Bus BIT 0
16	I/O	HD14	Host Data Bus BIT 14	36	I	HA2	Host Address Bus BIT 2
17	I/O	HD0	Host Data Bus BIT 0	37	I	HCS1	Host CHIP Select 0
18	I/O	HD15	Host Data Bus BIT 15	38	I	HCS3	Host CHIP Select 1
19	-	GND		39	I/O	DASP-	Drive Active/Drive 1 Present
20	-	(KEYPIN)		40	-	GND	