

SANYO

VCC-ZM300P

INSTRUCTION MANUAL BEDIENUNGSANLEITUNG MANUEL D'INSTRUCTIONS

使用说明书

COLOUR CCD ZOOM camera CCD-Farb-Zoomkamera Caméra CCD COULEURS avec ZOOM

彩色CCD变焦摄像机

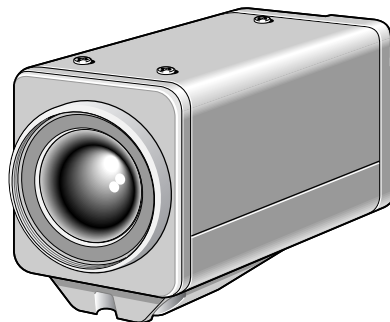

About this manual

Before installing and using the camera, please read this manual carefully. Be sure to keep it handy for later reference.

Über diese Bedienungsanleitung

Lesen Sie bitte vor der Montage und dem Inbetriebnehmen der Kamera zuerst diese Bedienungsanleitung sorgfältig durch und bewahren Sie sie zum späteren Nachschlagen auf.

A propos de ce manuel

Avant d'installer et d'utiliser la caméra, veuillez lire ce manuel attentivement. Gardez-le à portée de main pour toute référence ultérieure.

关于本说明书

在安装和使用摄像机之前，请仔细阅读本使用说明书，并务必保存好本使用说明书，以备今后查阅。

CONTENTS

MAIN FEATURES	2	■ LEVEL setting	29
ACCESSORIES	2	■ Manual iris setting	30
PRECAUTIONS	3	B WHITE BALANCE adjustment	31
PARTS NAMES AND FUNCTIONS	4	■ MWB setting	32
CONNECTIONS	6	■ ATW setting.....	32
■ Basic connection for monitoring or recording.....	6	■ AWC setting	34
■ Connection of peripheral equipment and controller terminal	7	C Electronic SHUTTER setting	35
DISPLAYING/CLOSING THE MENU SCREEN	8	■ Fast shutter speed (SHORT) mode setting.....	35
MENU ITEM FLOW AND MENU OPERATION	9	■ Slow shutter speed (LONG) mode setting.....	36
LANGUAGE SETTING	10	D MOTION detector setting	37
CAMERA ID SETTING.....	11	■ MOTION MASKING setting	39
■ Camera ID setting.....	11	■ SENSITIVITY setting.....	40
SYNC SETTING (SYNC)	12	■ ZOOM setting.....	41
■ Power source synchronization (L-L) setting	12	■ INTERVAL setting.....	41
PRIVACY MASK SETTING (PRIVACY MASK)	13	■ ALARM SIGN setting.....	42
■ Mask setting	13	E Profile compensation setting (APERTURE)	43
■ PASSWORD setting	15	F Automatic gain control (AGC) setting	44
■ PASSWORD LOCK cancellation.....	16	G GAMMA correction setting.....	45
■ PASSWORD changes	16	OPTION SETTING	46
LENS SETTING (LENS).....	17	■ CONTROL setting	46
■ FOCUS setting.....	17	■ ADDRESS setting.....	47
■ ZOOM setting	20	■ ALARM setting	47
MIRROR SETTING.....	21	A Alarm input setting (ALARM IN)	47
VIEW SETTING ITEM FLOW.....	22	B Alarm output setting (ALARM OUT)	49
VIEW SETTING.....	24	C Operation of alarm signal output to the System Controller setting (LINE OUT)	50
A IRIS setting	24	MENU FLOW.....	51
■ Autoiris setting (AUTO)	24	SPECIFICATIONS	53
■ SENSE UP setting.....	29		

MAIN FEATURES

- Built in Interline transfer method 1/4" CCD, approx. 470,000 picture elements.
- High sensitivity, minimum required illumination is 2.0 lux. (F1.6, gain max)
- More than 520 TV lines of horizontal resolution.
- Equipped with intelligent Backlight compensation.
- Special Gamma mode (contrast up)
- Built in high speed electronic shutter and slow shutter.
- 32X Electronic sensitivity
- Built in Digital Motion Detection
- Built in Privacy masking function
- 12VDC/24V AC dual operation(electrically isolate) .
- Internal sync. / Line Lock.
- 22x optical zoom and 16x electronic zoom.
- Coaxial control or RS485, operation via SSP.

ACCESSORIES

Clamping core 1 pc.

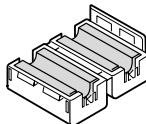

PRECAUTIONS

■ In case of problem

Do not use the camera if smoke or a strange odour comes from the unit, or if it seems not to function correctly. Disconnect the power cord immediately, and consult your dealer (or a Sanyo Authorized Service Centre).

■ Do not open or modify

Do not open the cabinet, as it may be dangerous and cause damage to the unit. For internal settings and repairs, consult your dealer (or a Sanyo Authorized Service Centre).

■ Do not put objects inside the unit

Make sure that no metal objects or flammable substance get inside the camera. If used with a foreign object inside, it could cause a fire, short-circuits or damages.

If water or a liquid gets inside the camera, disconnect the power cord immediately, and consult your dealer (or a Sanyo Authorized Service Centre). Be careful to protect the camera from rain, sea water, etc.

■ Be careful when handling the unit

To prevent damages, do not drop the camera or subject it to strong shock or vibration.

■ Install away from electric or magnetic fields

If installed close to a TV, radio transmitter, magnet, electric motor, transformer, audio speakers the magnetic field they generate will distort the image.

■ Protect from humidity and dust

To prevent damages to the camera, do not install it where there is greasy smoke or steam, where the dampness may get too high, or where there is a lot of dust.

■ Protect from high temperatures

Do not install close to stoves, or other heat generating devices, such as spotlights, etc., or where it could be subject to direct sunlight, as that could cause deformation, discoloration or other damages.

Be careful when installing close to the ceiling, in a kitchen or boiler room, as the temperature may raise to high levels.

Install where the temperature range will stay between -10°C and 50°C . (no condensation)

■ Cleaning

- Dirt can be removed from the cabinet by wiping it with a soft cloth. To remove stains, wipe with a soft cloth moistened with a soft detergent solution and wrung dry, then wipe dry with a dry soft cloth.
- Do not use benzine, thinner or other chemical product on the cabinet, as that may cause deformation and paint peeling. Before using a chemical cloth, make sure to read all accompanying instructions. Make sure that no plastic or rubber material comes in contact with the cabinet for a long period of time, as that may cause damage or paint peeling.

PARTS NAMES AND FUNCTIONS

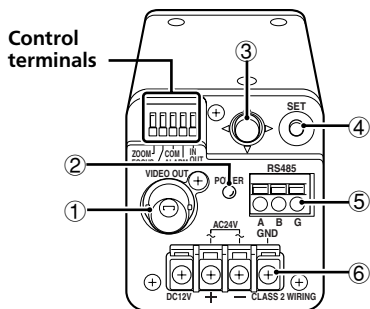

① Video output connector (VIDEO OUT: BNC type)

Connect this connector to a device such as a time lapse VCR or monitor with a **VIDEO IN** connector.

② Power indicator (POWER)

Comes on when the power to the camera is on.

Note: After connecting the power supply the POWER indicator will blink for 5 seconds. During this time no adjustments using the menus or any other operation are possible.

③ Cursor button (See p8)

- ▲: Press this button to move the cursor up.
- ▶: Press this button to move the cursor to the right, or to turn the settings ON/OFF etc.
- ◀: Press this button to move the cursor to the left, or to turn the settings ON/OFF etc.
- ▼: Press this button to move the cursor down.

④ Menu setting button (SET) (See p8)

Connect the camera to the monitor, then press the **SET** button for about 3 seconds to display the on-screen menu.

⑤ RS-485 control push-lock terminals (RS485, A, B, G)

Use a cable thicker than AWG22.

A: Twisted-pair cable terminal

G: Ground terminal

B: Twisted-pair cable terminal

⑥ 24 V AC or 12 V DC input terminals (AC 24 V, DC 12 V, GND)

Lens cap

The cap is installed to protect the lens section. Remove the cap when using the camera.

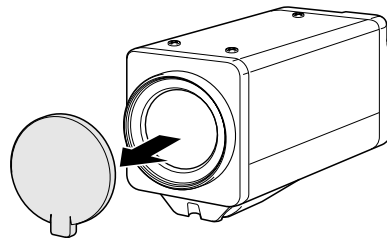

PARTS NAMES AND FUNCTIONS

Camera installation bracket

The bracket can be fixed at the top or bottom of the camera. When fixing the bracket, be sure to use the longer screws and install the shorter screws on the opposite side to seal the openings.

CAUTION: When installing the camera bracket, select a location that can support the total weight of the camera and accessories.

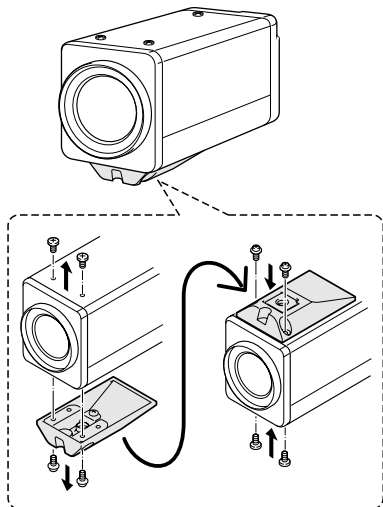

Control terminals

① Zoom terminal (ZOOM)

Sets the zoom to wide angle or telescoping.

② Focus terminal (FOCUS)

Sets the focus to infinite or close range.

③ Grounding terminal (COM)

④ Alarm output terminal (ALARM OUT)

A detection alarm based on the motion sensor is sent to connected equipment such as a buzzer or lamp or a time lapse VCR device.

⑤ Alarm input terminal (ALARM IN)

Used for detection of intruders through a connected external alarm switch.

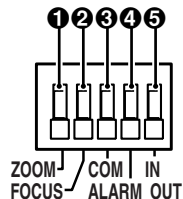

CONNECTIONS

■ Basic connection for monitoring or recording

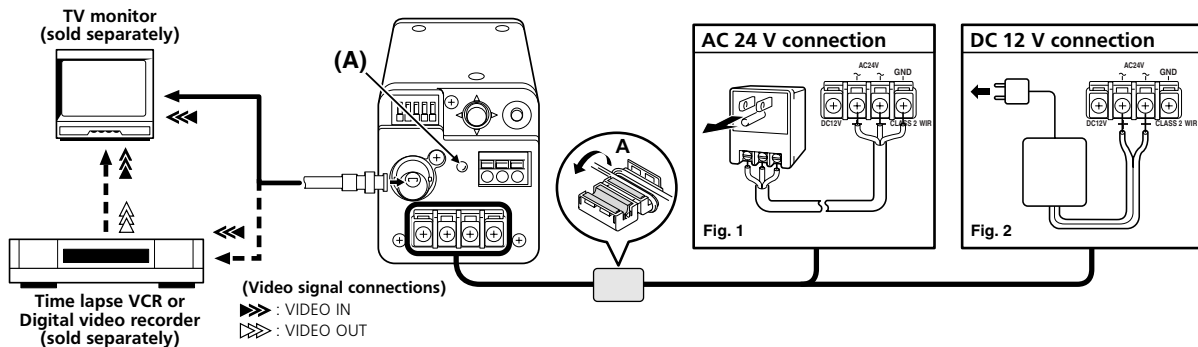

The peripheral devices (VCR, monitor, lens, etc.) and cables are sold separately.

1 Make the video signal connection between the camera and the monitor or time lapse VCR.

When using this unit, the supplied clamping core A must be installed on the power cord and BNC cable, in order to prevent electromagnetic interference to the other devices connected.

2 Power supply choices

- Use a commercially available 24 V AC adaptor. Make sure to use a cable with an earth line (22AWG or more) to connect to the grounding terminal. (Fig. 1.)
- When using a DC 12 V power supply, make the connections as indicated in Fig. 2.

CAUTION:

To prevent camera and/or power supply failure, pay close attention to polarity when making the connections.

3 Insert the plug of this power supply into a wall outlet.

The **POWER** indicator (A) will light. Adjust the picture on the monitor using the Brightness and Contrast controls.

CONNECTIONS

■ Coaxial cable type and maximum length

- Cable type RG-59U (3C-2V), 250 m maximum.
- Cable type RG-6U (5C-2V), 500 m maximum.
- Cable type RG-11U (7C-2V), 600 m maximum.

CAUTION:

- The RG-59U type cable should not be run through electrical conduits or through the air.
- Using CCTV/Video-grade coaxial cable.

■ Connection of peripheral equipment and controller terminal

- Focus adjustment
DC-6V/12V: Infinite
DC+6V/12V: Close range
- Zoom adjustment
DC-6V/12V: Wide angle
DC+6V/12V: Telescoping

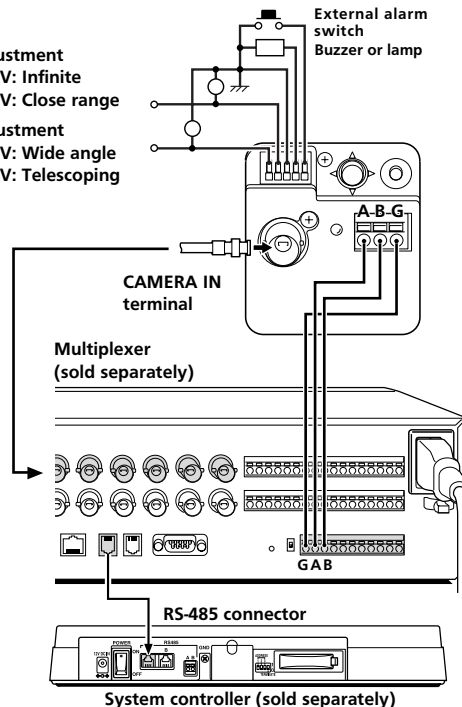

DISPLAYING/CLOSING THE MENU SCREEN

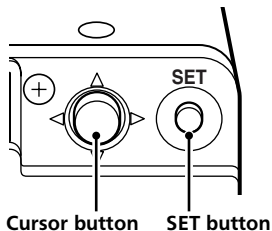

MAIN MENU screen

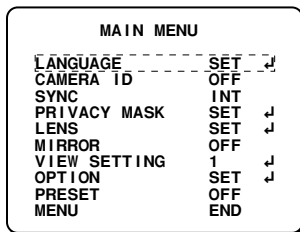

Sub-menu screen

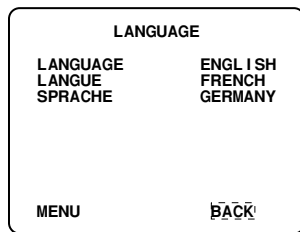

1 Press the SET button for about 3 seconds.

The **MAIN MENU** screen will appear.

2 Using the cursor button

- 1 Use the cursor button (▼) to move the cursor down. When the cursor reaches the bottom of the screen, it goes back up to the top of the screen.
- 2 Use the cursor button (▲) to move the cursor up. When the cursor reaches the top of the screen, it goes back down to the bottom of the screen.
- 3 Use the cursor button (▶) to move the cursor to the right. This button is also used to change ON/OFF settings etc.
- 4 Use the cursor button (◀) to move the cursor to the left. This button is also used to change ON/OFF settings etc.

3 Switching to sub-menu screens

Use the cursor button (▲▼◀▶) until an item with a "↕" next to it is flashing, then press the **SET** button.

4 Closing a settings screen

- To return to the previous screen, use the cursor button (▼) to select BACK for MENU, then press the **SET** button.
- To return to the normal screen, use the cursor button (◀ or ▶) to select END for MENU, then press the **SET** button.

☞ Returning to the default setting

Use cursor button (▼, then ◀ or ▶) to change the **PRESET** setting to **ON**, then press the **SET** button.

MENU ITEM FLOW AND MENU OPERATION

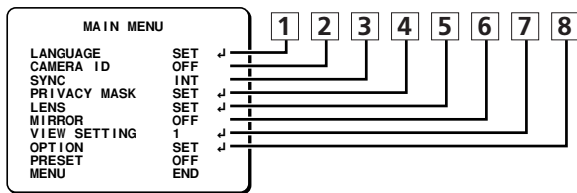

1 LANGUAGE setting (See p10)

Choose from among English, French and German.

2 CAMERA ID setting (See p11)

3 SYNC setting (See p12)

Sets camera to internal synchronization (INT) or power source synchronization (L-L).

Power source synchronization, the vertical synchronization phase as adjusted on a sub-menu screen.

4 PRIVACY MASK setting (See p13)

This covers an area of the screen with a gray pattern for areas that may infringe on privacy.

Gray patterns can be placed on up to 4 areas.

5 LENS setting (See p17)

Sets camera to automatic focus or manual focus. Zoom speed and magnification is also set here.

6 MIRROR setting (See p21)

The image can be rotated horizontally then vertically or vertically then horizontally.

7 VIEW SETTING (See p22)

Different detailed settings can be made for each camera (9 screens). After they are set, these are linked to "VIEW SETTING (0 - 8)" settings for preset positions.

8 OPTION setting (See p46)

For setting communications conditions and alarms.

LANGUAGE SETTING

Select one of the languages shown on the menu screen (English, French, German).

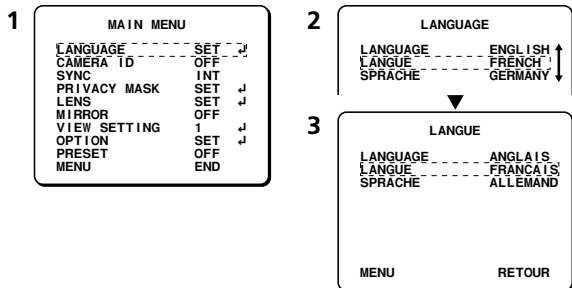

- 1** In the MAIN MENU, use the cursor button (▲ or ▼) to select SET for LANGUAGE, then press the SET button.

The LANGUAGE screen will appear.

- 2** Use the cursor button (▲ or ▼) to move the cursor to language (example: "FRENCH") then press the SET button.

The interface language becomes French.

- 3** Use the cursor button (▲ or ▼) to select RETUOR for MENU, then press the SET button.

The MENU PRINCIPAL screen will reappear.

Information in the MAIN MENU screen will appear in the selected language.

- 4** Use the cursor button (▼) to select FIN, then press the SET button. The display will return to the normal monitor screen.

CAMERA ID SETTING

■ Camera ID setting

Example: Setting the Camera ID to "CAM 1"

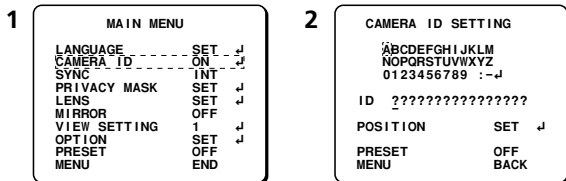

- 1 Use the cursor button (▲ or ▼) to move the cursor to **CAMERA ID**, and then use the cursor button (◀ or ▶) to change the setting to **ON**. Then press the **SET** button.

The CAMERA ID SETTING screen will appear.

- 2 Use the cursor button (▲ ▼ ◀ ▶) to move the cursor to the letter "C" in the character selection palette, then press the **SET** button.

- After at least one character is displayed in the ID field, the carriage return mark (↵) will appear at the lower right corner of the character selection palette. Selecting this mark between the characters of the field will create a new line at that place.

- 3 Use the same steps to select "A", "M" and "1" from the palette, then press the **SET** button.

The characters "CAM1" appear in the ID field.

ID CAM1????????????

Camera ID screen

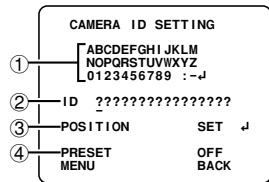

① Character selection palette:

By moving the cursor to letters or numbers in this palette, you can select characters.

Selected characters will appear in the corresponding field under ID.

② ID:

The ID entry field shows 16 question marks (?). The ID will not be displayed on the screen.

③ POSITION:

After characters are displayed in the ID field, moving the cursor to the POSITION field with the cursor button and pressing the **SET** button will display the camera ID on the normal screen.

④ PRESET:

When this item is turned to **ON**, the ID fields are cleared (question marks appear). Use this function when you want to change the ID.

CAMERA ID SETTING

- 4 Use the cursor button (▲ or ▼) to move the cursor to **POSITION**, and then press the **SET** button.

The camera ID will be displayed on one line.

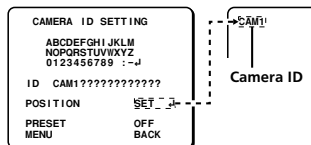

(Displaying the ID on 2 lines.)

- 1 Use the cursor button (◀ or ▶) to move the cursor to the location in the ID field where the carriage return is wanted.
 - 2 Use the cursor button (▲ ▼ ◀ ▶) to move the cursor to the carriage return mark (↵) at the lower right corner of the character selection palette, and then press the **SET** button.
- 5 Moving the on-screen title display position
- Use the cursor button (▲ ▼ ◀ ▶) to move the title display to the preferred position on the screen, then press the **SET** button.
- The CAMERA ID SETTING screen will reappear.

SYNC SETTING (SYNC)

Initial setting is internal synchronization (INT), so it does not need to be set again. Follow the steps below to change the setting to power source synchronization (L-L).

■ Power source synchronization (L-L) setting

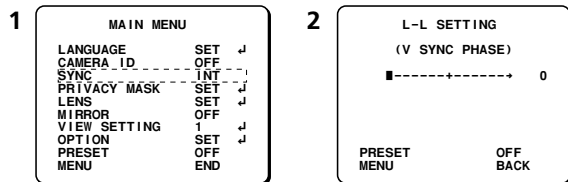

- 1 Use the cursor button (▲ ▼ ◀ ▶) to select L-L for **SYNC**, then press the **SET** button.
The L-L SETTING screen will appear.
 - 2 Use the cursor button (◀ or ▶) to adjust the position of the vertical synchronization indicator shown on the screen.
The numerical value will change, allowing adjustment of vertical synchronization.
- 🔊 To close the menu screen or return to the previous screen, select **BACK** or **END** for **MENU** and press the **SET** button.

PRIVACY MASK SETTING (PRIVACY MASK)

■ Mask setting

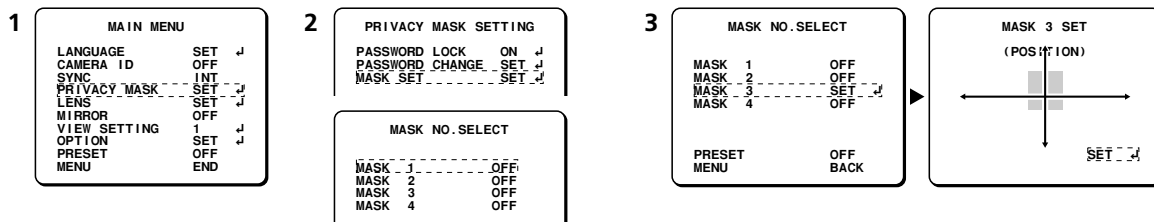

- 1** Use the cursor button (▲ or ▼) to select SET for PRIVACY MASK, then press the SET button.

The PRIVACY MASK SETTING screen will appear.

- 2** Use the cursor button (▲ or ▼) to move the cursor to SET for MASK SET and press the SET button.

The MASK NO. SELECT screen will appear.

Note: When PASSWORD LOCK is ON, moving the cursor to MASK SET and press the SET button to bring up a password access screen. The password must be entered in this screen.

- 3** Use the cursor button (▲ or ▼) to move the cursor to a mask number (Ex: MASK 3), and then use the cursor button (▶) to change the setting to SET. Then press the SET button.

The MASK 3 SET (POSITION) screen will appear, and SET↵ will be blinking. The gray mask will appear in the center of the screen.

Cursor button operation

OFF: to ▶ side (ON appears), to ▶ side again (SET appears)

- **SET:** Mask POSITION and SIZE can be set
- **ON:** Masks can be displayed
- **OFF:** Masks can be deleted

PRIVACY MASK SETTING (PRIVACY MASK)

(About the POSITION screen)

It is possible to set as many as 4 masks on the same POSITION screen.

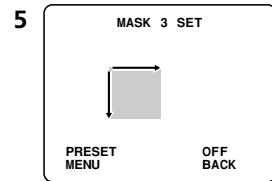
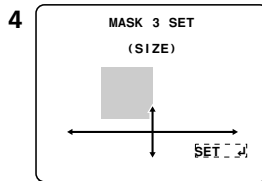
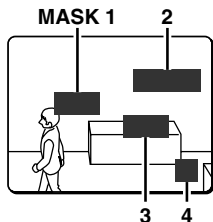

- 4** Use the cursor button (▲▼◀▶) to move the gray mask, then press the SET button.

The SIZE screen will appear, and the mask that was positioned in the POSITION screen will be displayed.

- 5** Use the cursor button (▲▼◀▶) to adjust the size of the gray mask, then press the SET button.

PRESET and MENU will appear at the bottom of the screen. Move the cursor to BACK for MENU and press the SET button. The screen will return to MASK NO. SELECT.

- ⓘ** To close the menu screen or return to the previous screen, select BACK or END for MENU and press the SET button.

PRIVACY MASK SETTING (PRIVACY MASK)

■ PASSWORD setting

You can lock the privacy masks in place as gray patterns after they have been set. The password requirement is initially set to OFF, but to begin using it, you must enter the factory set password "1234".

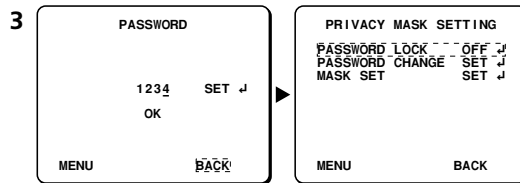
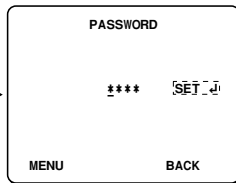
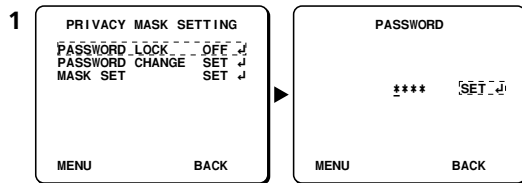

- 1 Use the cursor button (▲ or ▼) to move the cursor to OFF for PASSWORD LOCK in the PRIVACY MASK SETTING screen. Then press the SET button.

The PASSWORD screen will appear.

- 2 Enter the factory set password "1234".

Use the cursor button (▲ or ▼) to select "1", then use the cursor button (▶).

To move the cursor to the next "*" digit.



- 3 Use the same steps to enter "2," "3," and "4," then press the SET button.

"OK" will appear and BACK for MENU will be blinking. Press the SET button again. The PRIVACY MASK SETTING screen will reappear and "ON" will be blinking for PASSWORD LOCK.

Note: If a different password is required, "NG" will appear. Please carefully maintain the password so that it will not be forgotten.

PRIVACY MASK SETTING (PRIVACY MASK)

■ PASSWORD LOCK cancellation

For use when PASSWORD LOCK is ON

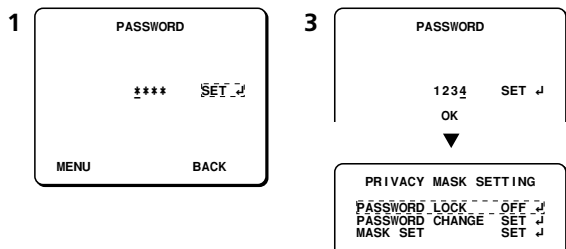

1 Press the SET button.

The PASSWORD screen will appear.

2 Enter the factory set password "1234".

Use the cursor button (▲ or ▼) to select "1", then use the cursor button (▶).

To move the cursor to the next "*" digit.

3 Use the same steps to enter "2," "3," and "4," then press the SET button.

"OK" will appear and BACK for MENU will be blinking. Press the SET button again. The PRIVACY MASK SETTING screen will reappear and "OFF" will be blinking for PASSWORD LOCK.

■ PASSWORD changes

You can change the password with PASSWORD LOCK in either the ON or OFF setting.

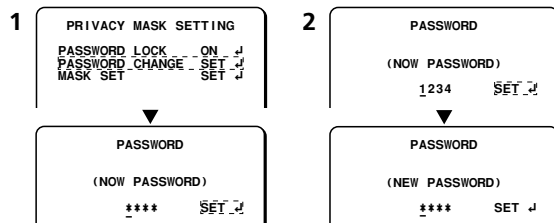

1 Use the cursor button (▲ or ▼) to move the cursor to SET for PASSWORD CHANGE and press the SET button.

The PASSWORD (NOW PASSWORD) screen will appear.

2 Use the cursor button (◀ or ▶, ▲) to enter the current password (Ex: 1234), then press the SET button.

The PASSWORD (NEW PASSWORD) screen will appear.

3 Use the cursor button (◀ or ▶, ▲) to enter a new password (Ex: 4321), then press the SET button.

"OK" will appear and BACK for MENU will be blinking. Press the SET button again.

The PRIVACY MASK SETTING screen will reappear.

LENS SETTING (LENS)

This item allows adjustment of focus (for manual focus or autofocus) and adjustment of zoom when needed.

■ FOCUS setting

☞ Setting the manual focus (MANU)

Sets a limit for near distance focusing and sets focus speed for manual focus.

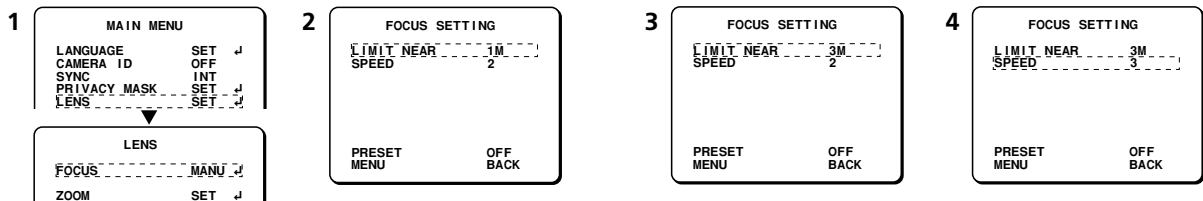

- 1** Use the cursor button (▲ or ▼) to select SET for LENS, then press the SET button.

The LENS screen will appear.

- 2** Use the cursor button (◀ or ▶) to select MANU, then press the SET button.

The FOCUS SETTING screen will appear.

- 3** LIMIT NEAR focus distance setting

Use the cursor button (▲ or ▼) to move the cursor to LIMIT NEAR, then use the cursor button (◀ or ▶) to change the distance value. (Ex: 3M)

Available settings: 1M (meter), 3M, 5M, 10C (centimeters), 30C, 50C

Note: Focusing becomes difficult when near distance limit is set to less than "1M".

- 4** SPEED of focus setting

Use the cursor button (▲ or ▼) to move the cursor to SPEED, then use the cursor button (◀ or ▶) to select the focus adjustment speed value. (Ex: 3)

Available settings: 1, 2, 3, 4 (Quickest speed)

- ☞ To close the menu screen or return to the previous screen, select BACK or END for MENU and press the SET button.

LENS SETTING (LENS)

Setting the autofocus (AUTO)

Sets a limit for near distance focusing and sets focusing sensitivity and focus iris.

Note: As a normal practice, use manual focus when keeping the camera focused on the same target object for a long period of time (over 24 hours). This can be used with the one-push autofocus function when needed (operated from the system controller). Long periods of surveillance with the autofocus in operation will shorten the work life of the lens.

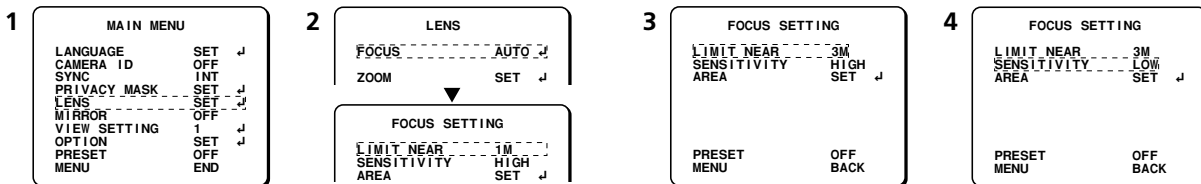

- 1 Use the cursor button (▲ or ▼) to select SET for LENS, then press the SET button.**

The LENS screen will appear.

- 2 Use the cursor button (◀ or ▶) to select AUTO, then press the SET button.**

The FOCUS SETTING screen will appear.

- 3 LIMIT NEAR focus distance setting**

Use the cursor button (▲ or ▼) to move the cursor to LIMIT NEAR, then use the cursor button (◀ or ▶) to change the distance value. (Ex: 3M)

Available settings: 1M (meter), 3M, 5M, 10C (centimeters), 30C, 50C

Note: Focusing becomes difficult when near distance limit is set to less than "1M".

- 4 Setting focus SENSITIVITY**

Use the cursor button (▲ or ▼) to move the cursor to SENSITIVITY, then use the cursor button (◀ or ▶) to change the setting. (Ex: LOW)

Available settings:

- **HIGH:** High sensitivity focusing
- **LOW:** Low sensitivity focusing

Note: When focus SENSITIVITY is set to **HIGH**, it may react to even slight movements of the target object. In this case, change the setting to **LOW**.

LENS SETTING (LENS)

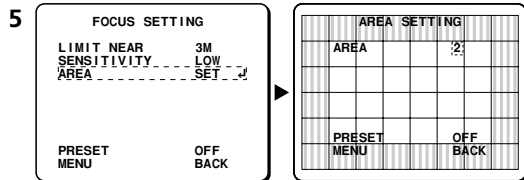

- 5 Use the cursor button (▲ or ▼) to move the cursor to SET for AREA, and press the SET button.

The AREA SETTING screen for AREA 2 (initial setting) will appear to allow setting of focus target area.

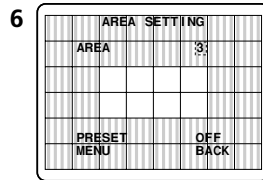

- 6 Use the cursor button (◀ or ▶) to select the focus target area. (Ex: 3)

The focus target area will become narrow.

Available settings: 1/full screen, 2/center of screen, 3/smaller center

- ☞ To close the menu screen or return to the previous screen, select BACK or END for MENU and press the SET button.

LENS SETTING (LENS)

■ ZOOM setting

Sets zooming speed and magnification power of the electronic zoom. This item also has a setting for improvement of vertical resolution of still pictures.

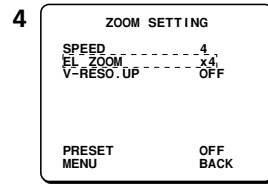
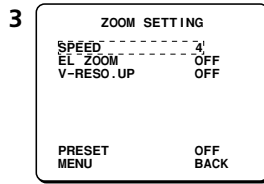
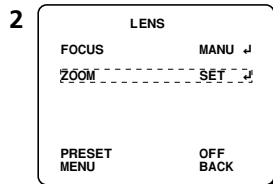
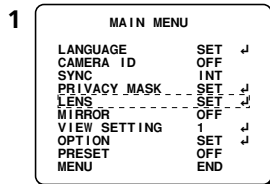

- 1 Use the cursor button (▲ or ▼) to select SET for LENS, then press the SET button.

The LENS screen will appear.

- 2 Use the cursor button (▲ or ▼) to select SET for ZOOM, then press the SET button.

The ZOOM SETTING screen will appear.

- 3 Zoom speed setting

Use the cursor button (◀ or ▶) to select the zooming speed. (Ex: 4)

Available settings: 1, 2, 3, 4 (Quickest speed)

- 4 EL ZOOM (Electronic zoom) magnification setting

Use the cursor button (▲ or ▼) to move the cursor to EL ZOOM, then use the cursor button (◀ or ▶) to select the electronic zoom magnification power. (Ex: x4)

Available settings: OFF, x2, x4, x8, x16 (16 power)

LENS SETTING (LENS)

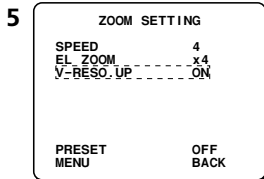

5 V-RESO.UP (Vertical resolution) setting

Use the cursor button (▲ or ▼) to move the cursor to V-RESO.UP, then use the cursor button (◀ or ▶) to select the vertical resolution. (Ex: ON)

Note: When V-RESO.UP is set to "ON", vertical resolution sensitivity for still pictures in the electronic zoom field will be improved but afterimages of moving objects will be more conspicuous.

👉 To close the menu screen or return to the previous screen, select BACK or END for MENU and press the SET button.

Note:

V-RESO. UP will be automatically set to OFF when any of the following settings is made.

- IRIS: AUTO item SENSE UP (activated)
- SHUTTER: LONG
- AGC: DNR (ON)

MIRROR SETTING

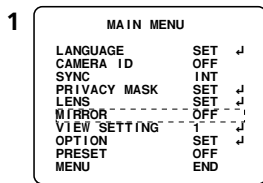

1 Use the cursor button (▲ or ▼) to move the cursor to MIRROR, then use the cursor button (◀ or ▶) to select the mirror image effect (Ex: H).

The image will be inverted horizontally. The image will change as described below each time the cursor button is pressed.

- OFF: Normal image
- V: Inverted vertically
- H: Inverted horizontally
- HV: Inverted horizontally and vertically



OFF



H



V



HV

2 To return to the normal screen, use the cursor button (▼) to select END at the bottom of the screen, then press the SET button.

VIEW SETTING ITEM FLOW

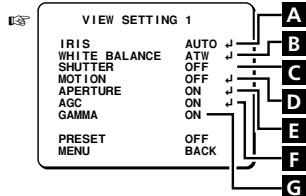
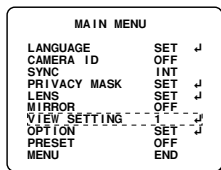

 Signifies that **VIEW SETTING 1** is the camera setting 1. The cursor button can be used (◀ or ▶) to select one of the nine **VIEW SETTING** patterns (0 – 8).

A IRIS setting (See p24)

This setting allows selection of IRIS to either autoiris (AUTO) or manual iris (MANU). Initial setting is autoiris.

B WHITE BALANCE adjustment (See p31)

This selects the white balance method to be used. Three white balance methods are available: auto trace white balance (ATW), one-push automatic white balance (AWC), and manual white balance (MWB). Default setting is auto trace white balance.

C Electronic SHUTTER setting (See p35)

This setting chooses either a fast shutter speed (SHORT) for target objects that may be moving quickly or a slower shutter speed (LONG) for darker target objects.

D MOTION detector setting (See p37)

This function generates an alarm when a suspicious figure is detected. Each of the settings will enable certain kinds of detection based on the natural image (swaying trees, flickers of light, etc.). It is also possible to enable zooming in on target objects and intruders that have unusual brightness levels (moving, bright) or are fast-moving.

E Profile compensation setting (APERTURE) (See p43)

This setting emphasizes the target object profile (horizontally or vertically).

F Automatic Gain Control (AGC) setting (See p44)

This sets the gain of the AGC circuit. When a target object is dark, the gain changes and the object becomes lighter.

G GAMMA correction setting (See p45)

This setting enables contrast sensitivity to be boosted by controlling the gamma characteristics. Three gamma controls are available: gamma correction (ON), smart gamma correction 1 (SMART 1), and smart gamma correction 2 (SMART 2). Initial setting is ON.

VIEW SETTING ITEM FLOW

(About creating image setting files in VIEW SETTING)

You can set 9 different patterns with view files. Use the cursor button (◀ or ▶) to change the file number (1) for VIEW SETTING and press the **SET** button. The selected image setting file will appear. Neither the mask function nor the motion detector function can be used with image setting file "0", so they will not appear as options in the screen for pattern 0.

MAIN MENU	
LANGUAGE	SET ↵
CAMERA ID	OFF ↵
SYNC	INT ↵
PRIVACY MASK	SET ↵
LENS	SET ↵
MIRROR	OFF ↵
VIEW SETTING	1 ↵
OPTION	SET ↵
PRESET	OFF ↵
MENU	END



VIEW SETTING 1	
IRIS	AUTO ↵
WHITE BALANCE	ATW ↵
SHUTTER	LONG ↵
MOTION	OFF ↵
APERTURE	ON ↵
AGC	ON ↵
GAMMA	ON
PRESET	OFF
MENU	BACK

(Screen for image setting 1-8)

VIEW SETTING 0	
IRIS	AUTO ↵
WHITE BALANCE	ATW ↵
SHUTTER	LONG ↵
MOTION	---
APERTURE	ON ↵
AGC	ON ↵
GAMMA	ON
PRESET	OFF
MENU	BACK

(Screen for image setting 0)

Note: When each of the following functions is ON (shown by single circle), it may be possible to use other functions in conjunction with it (shown by double circle). View columns vertically to determine which functions can be used together.

IRIS	AUTO: SENSE UP (activated)	○	×	×	×	×
	MANU: EI (ON)	×	○	×	×	◎
SHUTTER	LONG	×	×	○	×	×
	SHORT	×	×	×	○	◎
MOTION		×	◎	×	◎	○

○: Function is set ×: Not allowable ◎: Allowable

VIEW SETTING

A IRIS setting

There are 2 possible settings for IRIS, autoiris (AUTO) and manual iris (MANU).

■ Autoiris setting (AUTO)

Sets backlight compensation, magnification of electronic sensitivity and iris level.

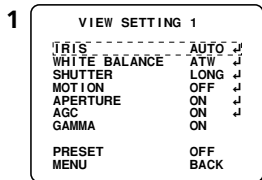

1 Use the cursor button (▲ or ▼) to move the cursor to VIEW SETTING, then press the SET button. (Ex: 1)

The VIEW SETTING 1 screen will appear and AUTO for IRIS will be blinking.

Available settings:

- **AUTO:** Sets automatic adjustment of iris.
- **MANU:** Sets manual adjustment of iris.

Note: When AUTO is selected, the following 3 types of detailed backlight compensation settings will be available.

- Multi-spot evaluative metering (MULT)
- 5 spot centerweighted average metering (CENT)
- 48 multi-spot metering (MASK)

2 Press the SET button.

The IRIS SETTING screen will appear.

VIEW SETTING

Backlight compensation additional settings 1

● Multi-spot evaluative metering (MULT)

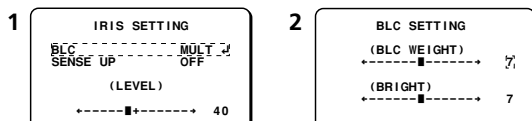

- 1 Use the cursor button (▲ or ▼) to move the cursor to BLC, then use the cursor button (◀ or ▶) to select a backlight compensation method. (Ex: MULT) Then press the SET button.

The BLC SETTING screen will appear.

Available settings:

- **MULT** (Multi-spot evaluative metering): Evaluates the entire screen and corrects according to the best image obtained.
 - **CENT** (5 spot centerweighted average metering): Measures light mainly at the center and corrects according to the best image obtained. (See p26)
 - **MASK** (48 multi-spot metering): Covers bright areas such as persons with mask patterns and treats light measurement output as irrelevant. (See p28)
- 2 Use the cursor button (◀ or ▶) to select the value of BLC WEIGHT. (Sets backlight and brightness level.)

Available settings: 0 – 15

Note: The larger the number, the more backlighting works.

- 3 Use the cursor button (▲ or ▼) to move the cursor to BRIGHT, and then use the cursor button (◀ or ▶) to select the compensation level.

Available settings: 0 – 15

Note: When the number becomes larger, it brightens, and the compensation level can be set for the brightness of the backlighting.

☰ To close the menu screen or return to the previous screen, select BACK or END for MENU and press the SET button.

Note: When using multi-spot evaluative metering, the background behind the target object will become very dark. If a target image in the center of the image is too bright while using the multi-spot evaluative metering mode, switch to the **5 spot centerweighted average metering** mode.

VIEW SETTING

Backlight compensation additional settings 2

- 5 spot centerweighted average metering (CENT)

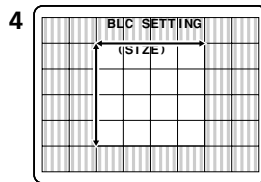
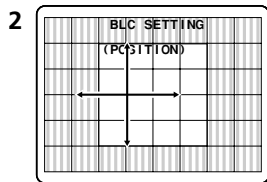
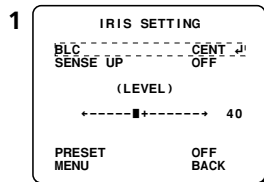

- 1** Use the cursor button (◀ or ▶) to select CENT, then press the SET button.

The BLC SETTING (POSITION) screen will appear.

- 2** Use the cursor button (▲ ▼ ◀ ▶) to shift the position of the central light sensing zone.

The zone can be moved up or down and left or right.

Note:

- If the zone fills the right side it will become smaller.
- If the zone fills the bottom side it will become smaller.

- 3** Press the SET button.

The BLC SETTING (SIZE) screen will appear.

- 4** Use the cursor button (▲ ▼ ◀ ▶) to adjust the size of the central light sensing zone.

- 5** Press the SET button.

The BLC WINDOW WEIGHTING screen will appear.

VIEW SETTING

Example of setting the mask in the center weighting position.

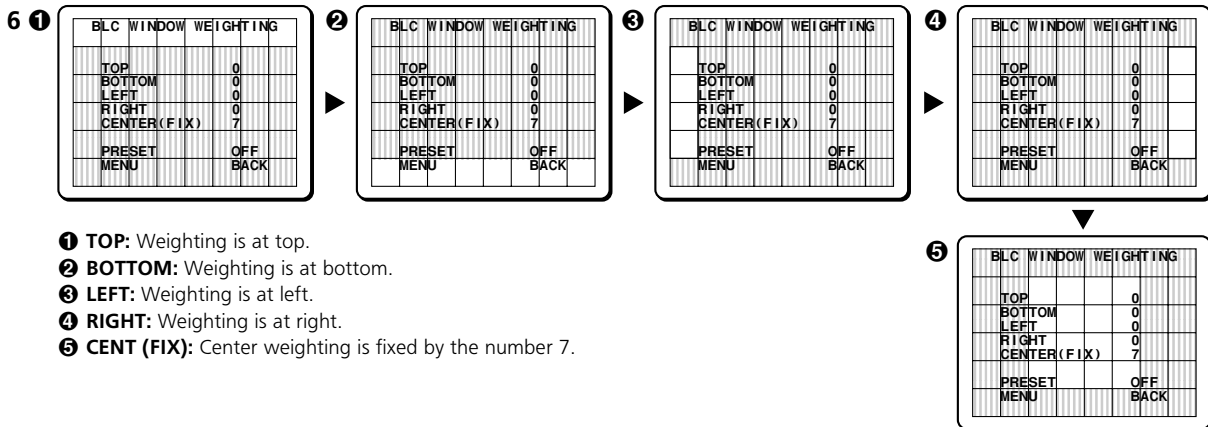

6 Use the cursor button (▲ or ▼) to select a zone, then use the cursor button (◀ or ▶) to adjust weighting.

Each setting will change as shown in the illustration.
The area from each of the zones 0 – 7, except CENTER, can be adjusted.

☞ To close the menu screen or return to the previous screen, select BACK or END for MENU and press the SET button.

VIEW SETTING

Backlight compensation additional settings 3

• 48 multi-spot metering (MASK)

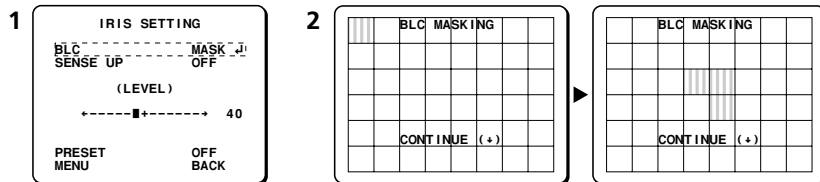

1 Use the cursor button (◀ or ▶) to select MASK, then press the SET button.

The BLC MASKING screen will appear and the mask pattern will be blinking.

2 Use the cursor button (▲ ▼ ◀ ▶) to move the cursor to move the mask pattern over the area not to be sensed, then press the SET button.

The mask pattern will be set. You can use the same steps to set additional mask patterns.

Note: The initial mask pattern is at the upper left of the screen, and it is not set. To clear a mask pattern after it is set, press the **SET** button again.

3 Finishing mask pattern setting

Use the cursor button (▲ or ▼) to move a mask pattern to the bottom area of the screen and continue holding it for 3 seconds. The PRESET and MENU items will appear on the screen.

- Use the cursor button (▼) to select BACK for MENU and press the **SET** button. The IRIS SETTING screen will reappear.
- Use the cursor button (▼) to move the cursor to BACK for MENU, use the cursor button (◀ or ▶) to select END, and then press the **SET** button. The normal screen will reappear.

VIEW SETTING

■ SENSE UP setting

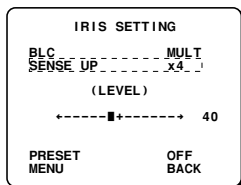

Use the cursor button (▲ or ▼) to move the cursor to SENSE UP, then use the cursor button (◀ or ▶) to select the power of the electronic sensitivity. (Ex: x4)

Available settings: OFF, x2, x4, x8, x16, x32

Note:

- Electronic sensitivity boosting (SENSE UP) automatically lengthens the CCD exposure time in dark situations. Accordingly, do not use for light target objects. Because exposure time is lengthened while in operation, moving target objects may cause conspicuous afterimages and blurs.
- It is not possible to set SENSE UP (activated) or SHUTTER (LONG) when MOTION is set to "ON".
- When SENSE UP is activated for IRIS SETTING, the electronic shutter cannot be forcibly moved.

☞ To close the menu screen or return to the previous screen, select BACK or END for MENU and press the SET button.

■ LEVEL setting

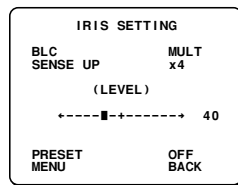

Use the cursor button (▲ or ▼) to move the cursor to LEVEL, then use the cursor button (◀ or ▶) to adjust the iris level.

Available settings: 0 – 100

Note: The larger the number, the more it brightens.

☞ To close the menu screen or return to the previous screen, select BACK or END for MENU and press the SET button.

VIEW SETTING

Manual iris setting

Sets electronic iris ON/OFF, lens aperture and iris level.

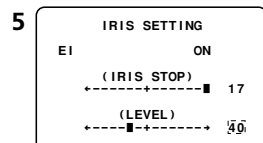
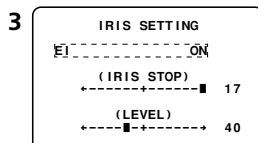
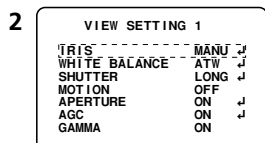
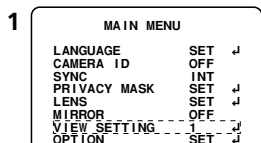

- 1** Use the cursor button (▲ or ▼) to move the cursor to **VIEW SETTING**, then press the **SET** button. (Ex: 1)

The VIEW SETTING 1 screen will appear.

- 2** Use the cursor button (◀ or ▶) to select **MANU**, then press the **SET** button.

The IRIS SETTING screen will appear.

- 3** **Electronic IRIS setting**

Use the cursor button (◀ or ▶) to select **EI**. (Ex: ON)

Note: When SENSE UP is activated for IRIS SETTING, the electronic shutter cannot be forcibly moved.

- 4** **Lens aperture setting**

Use the cursor button (▲ or ▼) to move the cursor to **IRIS STOP**, then use the cursor button (◀ or ▶) to select the value.

Available settings: 1 – 17 (Aperture opening)

Note:

- The smaller the value the more the aperture closes and the image darkens.
- Changes to the value directly control the aperture of the lens.

- 5** Use the cursor button (▲ or ▼) to move the cursor to **LEVEL**, then use the cursor button (◀ or ▶) to select the value.

Available settings: 0 – 100 (Level of opening)

Note:

- The smaller the value the more the video level drops, becoming darker.
- The LEVEL setting controls both AGC circuit gain and shutter speed, changing the amount of exposure.

To close the menu screen or return to the previous screen, select BACK or END for MENU and press the SET button.

Note:

- If the iris views an unusually bright image, it can cause a smear that cannot be corrected by adjusting the light entering through the lens. In this case, arrange the physical angle of lighting in a way that will prevent on-screen smearing.
- If flickering of the target object occurs because of fluorescent lighting in the camera location, changing to incandescent lighting will prevent the flickering.

VIEW SETTING

B WHITE BALANCE adjustment

Adjustments can be made to 3 methods of white balance correction: Auto trace white balance (ATW), one-push automatic white balance (AWC), and manual white balance (MWB).

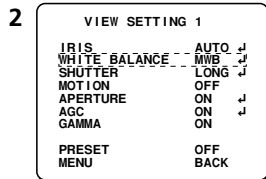
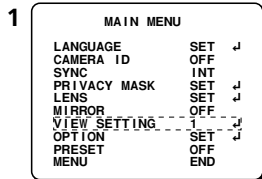

- 1 Use the cursor button (▲ or ▼) to move the cursor to **VIEW SETTING**, then press the SET button. (Ex: 1)

The VIEW SETTING 1 screen will appear.

- 2 Use the cursor button (▲ or ▼) to move the cursor to **WHITE BALANCE**, then use the cursor button (◀ or ▶) to select a white balance type "MWB". Then press the SET button.

The MWB SETTING screen will appear.

The following methods are available for white balance correction. See the corresponding reference sections for additional setting options.

Available methods:

■ ATW (Auto trace white balance)

Even when light sources change, automatic adjustment assures capture of most suitable colors. When a bright light source prevents effective white balance, a mask can be placed over the light source. (See p32)

■ AWC (One-push automatic white balance)

White balance is adjusted automatically with one-push activation. AWC is usually set for white target objects (walls, paper, etc.) that do not return color faithfully in the ATW method. (See p34)

■ MWB (Manual white balance)

Fine adjustments for preferred colors can be done manually. This method is preferable when suitable colors cannot be obtained with the ATW method. (See p32)

VIEW SETTING

White balance additional settings 1

■ MWB setting

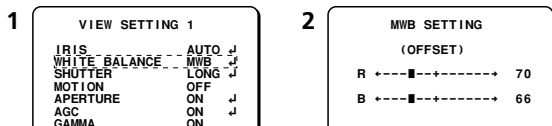

- 1 Use the cursor button (▲ or ▼) to move the cursor to **WHITE BALANCE**, then use the cursor button (◀ or ▶) to select a white balance type (Ex: MWB). Then press the SET button.

The MWB SETTING screen will appear.

- 2 Use the cursor button (◀ or ▶) to adjust the value for "R" (red).

Available settings: 0 – 255

Note: The larger the number, the stronger red becomes.

- 3 Use the cursor button (▲ or ▼) to move the cursor to "B", then use the cursor button (◀ or ▶) to adjust the "Blue" value.

Available settings: 0 – 255

Note: The larger the number, the stronger blue becomes.

- ☞ To close the menu screen or return to the previous screen, select BACK or END for MENU and press the SET button.

White balance additional settings 2

■ ATW setting

Automatic white balance settings are completed when ATW is selected. However, white balance will not be suitably adjusted if a bright light source or an excessively dark area from the environment is in the image. In this case, the bright light source or dark area should be masked so that it will not be detected.

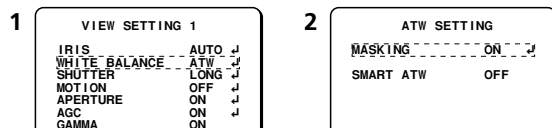

- 1 Use the cursor button (▲ or ▼) to move the cursor to **ATW** for **WHITE BALANCE** and press the SET button.

The ATW SETTING screen will appear.

- 2 Use the cursor button (◀ or ▶) to select **ON** for **MASKING**, then press the SET button.

The ATW MASKING screen will appear with the mask pattern blinking in the upper left corner of the screen.

VIEW SETTING

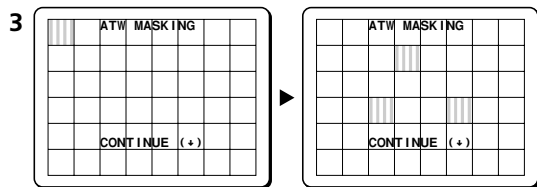

- 3** Use the cursor button (▲ ▼ ◀ ▶) to move the mask pattern over the bright light source, then press the SET button.

Use the same steps to place addition masks as needed.

Note: Initial settings place no masks on the screen. To cancel the placement of masks, press the SET button again.

- 4** Use the cursor button (▲ or ▼) to move a mask pattern to the bottom area of the screen and continue holding the cursor button straight down for 3 seconds.

The PRESET and MENU items will appear on the screen. Use the cursor button (▲ or ▼) to select BACK, then press the SET button. The ATW SETTING screen will reappear.

 To close the menu screen or return to the previous screen, select BACK or END for MENU and press the SET button.

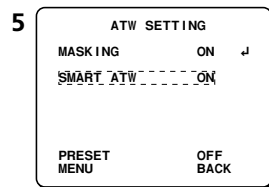
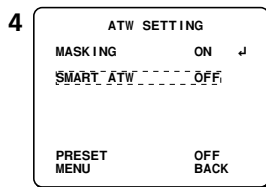

-  **SMART ATW setting**

If saturation is high or a scene is bright, the most suitable colors may not be obtained. In this case, set the SMART ATW to ON.

- 5** Use the cursor button (▲ or ▼) to move the cursor to SMART ATW, then use the cursor button (◀ or ▶) to set ON.

 To close the menu screen or return to the previous screen, select BACK or END for MENU and press the SET button.

VIEW SETTING

White balance additional settings 3

■ AWC setting

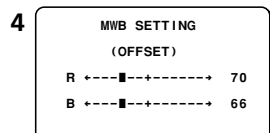
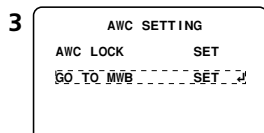
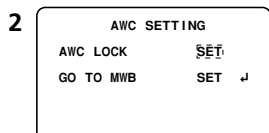
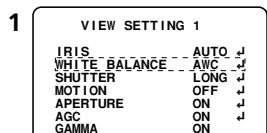

- 1** Use the cursor button (▲ or ▼) to move the cursor to **AWC** for **WHITE BALANCE** and press the **SET** button.

The AWC SETTING screen will appear.

- 2** With **SET** blinking for **AWC LOCK**, press the **SET** button.

SET will light and adjustment of white balance will begin. After about 3 seconds, SET will begin blinking again, signaling that adjustment is complete.

Note:

For even finer adjustment of coloration, choose SET for GO TO MWB. White balance mode will become MWB for fine adjustment. After fine adjustment with GO TO MWB, the white balance mode will automatically switch to MWB.

Note: Full adjustment may not be possible with just one activation of SET for AWC LOCK. In that case, press the **SET** button again.

- 3** **GO TO MWB** setting

Use the cursor button (▲ or ▼) to move the cursor to **SET** for **GO TO MWB** and press the **SET** button.

The MWB SETTING screen will appear and the “R” value will be blinking.

- 4** Use the cursor button (◀ or ▶) to adjust the value for “R” (red).

Available settings: 0 – 255

Note: The larger the number, the stronger red becomes.

- 5** Use the cursor button (▲ or ▼) to move the cursor to “B”, then use the cursor button (◀ or ▶) to adjust the “Blue” value.

Available settings: 0 – 255

Note: The larger the number, the stronger blue becomes.

☰ To close the menu screen or return to the previous screen, select **BACK** or **END** for **MENU** and press the **SET** button.

VIEW SETTING

C Electronic SHUTTER setting

Sets the electronic shutter to either the fast shutter speed mode (SHORT) or the slow shutter speed mode (LONG).

■ Fast shutter speed (SHORT) mode setting

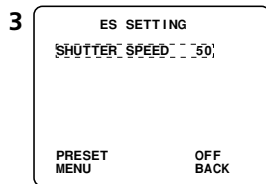
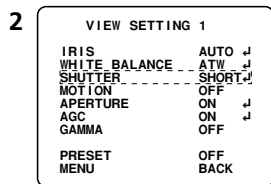
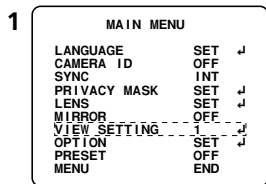

- 1** Use the cursor button (▲ or ▼) to move the cursor to **VIEW SETTING**, then press the SET button. (Ex: 1)

The VIEW SETTING 1 screen will appear.

- 2** Use the cursor button (▲ or ▼) to move the cursor to **SHUTTER**, then use the cursor button (◀ or ▶) to select the speed mode for the electronic shutter. (Ex: SHORT) Then press the SET button.

The ES SETTING screen will appear and 50 (1/50 sec) will be blinking. This setting is suitable for fast moving target objects.

- 3** Use the cursor button (◀ or ▶) to select a electronic shutter speed.

Available settings: 50, 120, 250, 500, 1000, 2000, 4000, 10000

Note: SHORT mode cannot be set if SENSE UP is activated or IRIS is "ON".

ⓘ To close the menu screen or return to the previous screen, select **BACK** or **END** for **MENU** and press the SET button.

VIEW SETTING

■ Slow shutter speed (LONG) mode setting

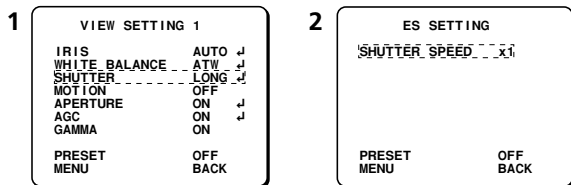

- 1 Use the cursor button (▲ or ▼) to move the cursor to **SHUTTER**, then use the cursor button (◀ or ▶) to select the speed mode for the electronic shutter. (Ex: LONG) Then press the SET button.

The ES SETTING screen will appear and x1 (1/50 sec) will be blinking. This setting is suitable for dark target objects.

Note: When a shutter speed is set, it can also be adjusted with the “ELS” button on the system controller.

- 2 Use the cursor button (◀ or ▶) to select a electronic shutter speed.

Available settings: x1, x2, x4, x8, x16, x32 (Field times shown as multiples.)

- ☞ To close the menu screen or return to the previous screen, select **BACK** or **END** for **MENU** and press the **SET** button.

Note:

SHUTTER (LONG) cannot be set if any of the following settings is active.

- **MOTION: ON**
- **IRIS: AUTO item SENSE UP (activated) or MANU item EI (ON)**

VIEW SETTING

D MOTION detector setting

This function divides the monitor screen into 48 zones (8 x 6). Based on information from the separate zones, target images that show intruder movements are detected and an alarm is generated. The degree of motion to be detected can be finely set.

Note:

- Before activating this setting, use the cursor button to select a surveillance location that will not detect motion.
- When SHUTTER speed is in **LONG** mode and IRIS SETTING has **SENSE UP** activated, the MOTION function cannot be turned **ON**.

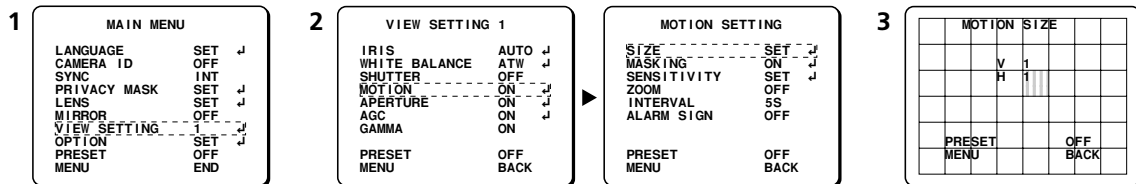

1 Use the cursor button (▲ or ▼) to move the cursor to **VIEW SETTING**, then press the **SET** button. (Ex: 1)

The VIEW SETTING 1 screen will appear.

2 Use the cursor button (▲ or ▼) to move the cursor to **MOTION**, and then use the cursor button (◀ or ▶) to select **ON**. Then press the **SET** button.

The MOTION SETTING screen will appear and **SET** for SIZE will be blinking.

3 MOTION SIZE setting

Sets the target object size desired for detection in the 48 zone screen.

Press the SET button again.

The MOTION SIZE screen appears and the "1" for "V" will be blinking.

VIEW SETTING

4 Set the size of the target object desired for detection

① Determine the vertical size

Tilt the cursor button to the right (▶).

The "V" value (vertical pattern) will change to "2" and the detection pattern will expand downward. Repeating this motion will expand the pattern in the up and down direction. Tilting the cursor button to the left will reduce the pattern size.

② Determine the horizontal size

Use the cursor button (▼) to move the cursor to the "1" for "H", then tilt the cursor button to the right (▶).

The "H" value (horizontal pattern) will change to "2" and the detection pattern will expand to the left. Repeating this motion will expand the pattern in the left and right direction. Tilting the cursor button to the left will reduce the pattern size.

🔍 To close the menu screen or return to the previous screen, select BACK or END for MENU and press the SET button.

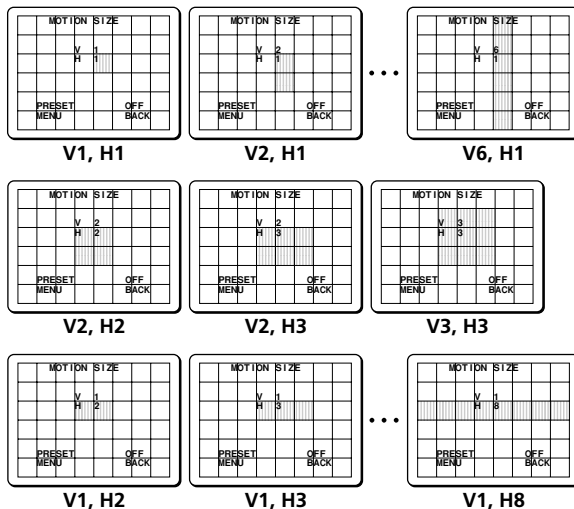

VIEW SETTING

■ MOTION MASKING setting

Masking target objects that are not desired for detection (swaying trees, flickers of light , etc.) will prevent unwanted alarms from being generated. This is done in the MOTION SETTING screen.

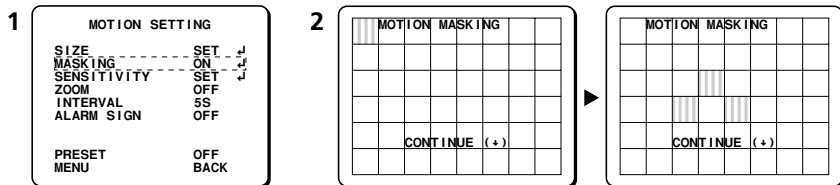

- 1 Use the cursor button (▲ or ▼) to move the cursor to **MASKING**, and then use the cursor button (◀ or ▶) to select **ON**. Then press the **SET** button.

The MOTION MASKING screen will appear, and the mask pattern will be blinking in the upper left corner of the screen.

- 2 Use the cursor button (▲ ▼ ◀ ▶) to move the mask pattern to the target object that is not to be detected, then press the **SET** button.

Repeat these steps to set mask patterns in other locations.

Note: To clear a mask pattern, press the **SET** button again on the pattern.

- 3 **Finishing motion pattern setting**

Use the cursor button (▲ or ▼) to move a mask pattern to the bottom area of the screen and continue holding it for 3 seconds. The **PRESET** and **MENU** items will appear on the screen.

- ☞ To close the menu screen or return to the previous screen, select **BACK** or **END** for **MENU** and press the **SET** button.

VIEW SETTING

■ SENSITIVITY setting

Set the degree of sensitivity for motion detection corresponding to MOTION SIZE. Sensitivity can be set so that natural motions on the screen such as wind and light changes will not be detected. When this is necessary, activate the following setting.

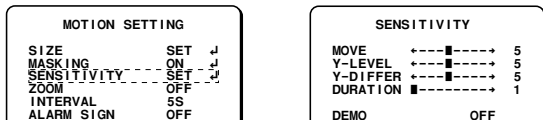

Use the cursor button (▲ or ▼) to move the cursor to **SENSITIVITY**, and then use the cursor button (◀ or ▶) to select **SET**. Then press the **SET** button.

The **SENSITIVITY** screen will appear.

When necessary, adjust the following settings.

☞ Motion sensitivity (MOVE) setting

Use the cursor button (▲ or ▼) to move the cursor to **MOVE**, then use the cursor button (◀ or ▶) to adjust the movement value.

To avoid detection of small movements such as wind, make the value larger.

Available settings: 1 – 10

☞ Brightness level (Y-LEVEL)

Use the cursor button (▲ or ▼) to move the cursor to **Y-LEVEL**, then use the cursor button (◀ or ▶) to adjust the brightness level.

When noise from a dark screen is causing erroneous detections, make the value larger.

Available settings: 1 – 10

☞ Brightness differences (Y-DIFFER)

Use the cursor button (▲ or ▼) to move the cursor to **Y-DIFFER**, then use the cursor button (◀ or ▶) to adjust the brightness differences.

Changes in brightness can sometimes be mistakenly detected as motion. To avoid detection of the turning on and off of lighting, make the value larger.

Available settings: 1 – 10

☞ DURATION setting

Use the cursor button (▲ or ▼) to move the cursor to **DURATION**, then use the cursor button (◀ or ▶) to adjust the detection time duration.

To avoid detecting fast movements, make the value larger.

Available settings: 1 – 60

☞ Detected motion confirmation mode (DEMO)

Use the cursor button (▲ or ▼) to move the cursor to **DEMO**, then use the cursor button (◀ or ▶) to change **ON**.

When a motion is detected, patterns are shown in that location. While the detected motion is being confirmed, the **SENSITIVITY** settings are optimized. This mode can only be activated in the **SENSITIVITY** setting screen.

☞ To close the menu screen or return to the previous screen, select **BACK** or **END** for **MENU** and press the **SET** button.

VIEW SETTING

■ ZOOM setting

This item is set in the MOTION SETTING screen.

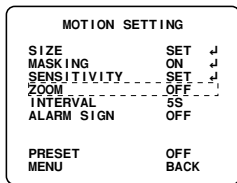

Use the cursor button (▲ or ▼) to move the cursor to ZOOM, then use the cursor button (◀ or ▶) to select the zoom magnification power (Ex.: x2).

Available settings: OFF, x1.4, x2, x2.8, x4, x6

Note:

- When a suspicious motion is detected, the camera zooms in according to the set magnification power. The zoom takes effect for 5 seconds and then returns to the previous magnification level.
- The zoom focuses on the center of the screen. If the maximum optical performance is exceeded, zooming will stop at maximum magnification.

☞ To close the menu screen or return to the previous screen, select BACK or END for MENU and press the SET button.

■ INTERVAL setting

This item is set in the MOTION SETTING screen.

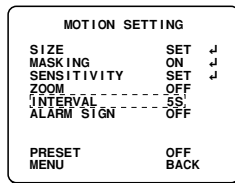

Use the cursor button (▲ or ▼) to move the cursor to INTERVAL, then use the cursor button (◀ or ▶) to select the time interval (Ex.: 15S).

Available settings: 5S, 10S, 15S, 20S, 30S, 1M, 2M, 3M, 4M, 5M

Note: When a motion is detected, no other motions will be detected within the set interval of time.

☞ To close the menu screen or return to the previous screen, select BACK or END for MENU and press the SET button.

VIEW SETTING

■ ALARM SIGN setting

This item is set in the MOTION SETTING screen.

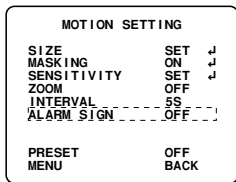

Use the cursor button (▲ or ▼) to move the cursor to OFF for ALARM SIGN, and then use the cursor button (◀ or ▶) to select ON.

Available settings:

- **ON:** The camera ID display blinks when motion is detected.
- **OFF:** The camera ID display does not blink when motion is detected.

☰ To close the menu screen or return to the previous screen, select BACK or END for MENU and press the SET button.

VIEW SETTING

E Profile compensation setting (APERTURE)

Set this function to further emphasize the profile of the target object. The amount of compensation can be adjusted for horizontal or vertical directions.

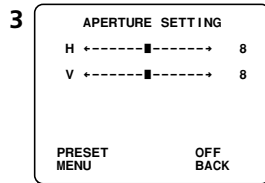
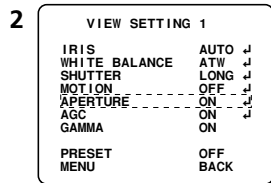
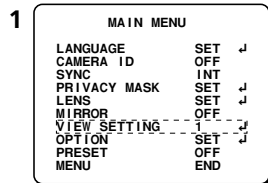

- 1 Use the cursor button (▲ or ▼) to move the cursor to **VIEW SETTING**, then press the SET button. (Ex: 1)

The VIEW SETTING 1 screen will appear.

- 2 Use the cursor button (▲ or ▼) to move the cursor to **APERTURE** and then use the cursor button (◀ or ▶) to select **ON**. Then press the SET button.

The APERTURE SETTING screen will appear and the "H" value will be blinking.

- 3 Select the amount of profile compensation

Available settings: 1 – 15 (Compensation intensity)

① Set the horizontal profile compensation

Use the cursor button (◀ or ▶) to adjust the value for "H" (horizontal).

② Set the vertical profile compensation

Use the cursor button (▲ or ▼) to move the cursor to "V" (vertical), then use the cursor button (◀ or ▶) to adjust the value for "V".

- ⏪ To close the menu screen or return to the previous screen, select **BACK** or **END** for **MENU** and press the SET button.

VIEW SETTING

F Automatic gain control (AGC) setting

Sets AGC to ON or OFF and adjusts the gain.

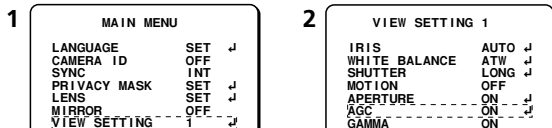

- 1 Use the cursor button (▲ or ▼) to move the cursor to **VIEW SETTING**, then press the SET button. (Ex: 1)
The VIEW SETTING 1 screen will appear.
- 2 Use the cursor button (▲ or ▼) to move the cursor to **AGC**, and then use the cursor button (◀ or ▶) to select the compensation level.

Available settings:

- **ON:** DNR (digital noise reduction) can be set
- **OFF:** Fixed gain values can be adjusted manually.

☞ When ON is set

- ① Use the cursor button (◀ or ▶) to select **ON** then press the SET button.
The GAIN SETTING screen will appear, and “±0dB” will be blinking.
- ② Use the cursor button (◀ or ▶) to select the gain.
Available settings: -6dB, ±0dB, +6dB, +9dB
- ③ Use the cursor button (▲ or ▼) to move the cursor to **DNR**, and then use the cursor button (◀ or ▶) to select **ON**.

(When ON is set)

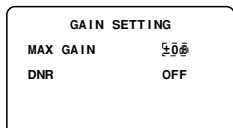

(When OFF is set)

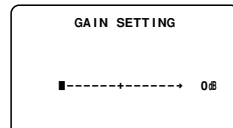

Available settings:

- **ON:** DNR (Digital Noise Reduction) is applied. Noise from low light will be reduced.
- **OFF:** DNR will not be applied.

Note: Digital noise reduction works as gain control becomes greater. If images for moving target objects have blurs or afterimages, reduce the resolution sensitivity.

☞ When OFF is set

- ① Use the cursor button (◀ or ▶) to select **OFF**, then press the SET button.
The GAIN SETTING screen will appear, and “0dB” will be blinking.
Available settings: 0 – 30dB
 - ② Use the cursor button (◀ or ▶) to adjust the gain.
- ☞ To close the menu screen or return to the previous screen, select **BACK** or **END** for MENU and press the SET button.

VIEW SETTING

G GAMMA correction setting

In addition to turning gamma correction ON or OFF, contrast sensitivity can be boosted at 2 levels.

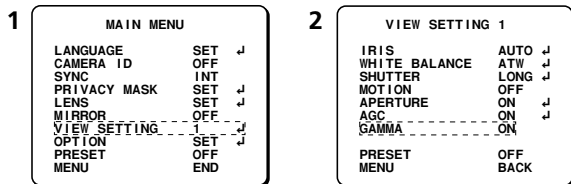

- 1 Use the cursor button (▲ or ▼) to move the cursor to **VIEW SETTING**, then press the **SET** button. (Ex: 1)

The VIEW SETTING 1 screen will appear.

- 2 Use the cursor button (▲ or ▼) to move the cursor to **ON** for **GAMMA**, then use the cursor button (◀ or ▶) to select the gamma correction.

Available settings:

- **OFF**: No gamma correction
- **ON**: Gamma correction ($\gamma = 0.45$)
- **SMART 1**: Correction 1
- **SMART 2**: Correction 2 (improves contrast for dark locations)

Note: When using SMART 1 or SMART 2, the target object may be too bright, so determine which setting is better for the target object.

-  To close the menu screen or return to the previous screen, select **BACK** or **END** for **MENU** and press the **SET** button.

OPTION SETTING

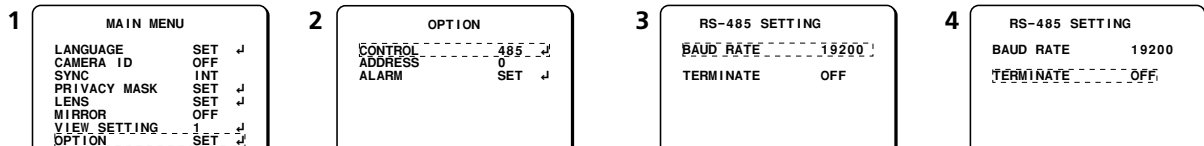

■ CONTROL setting

- 1 Use the cursor button (▲ or ▼) to move the cursor to **OPTION**, then press the **SET** button.

The OPTION screen will appear.

Note: The PRESET ON setting cannot be used when OPTION settings are in use.

- 2 Use the cursor button (▲ or ▼) to move the cursor to **485** for **CONTROL**, use the cursor button (◀ or ▶) to select the device to be operated (Ex: 485), and then press the **SET** button.

The RS-485 SETTING screen will appear.

Available settings:

- **485:** For operation by the System Controller
- **COAX:** For operation of device by linked coax cable.

- 3 Use the cursor button (◀ or ▶) to select **19200** for **BAUD RATE**.

Available settings: 19200, 9600, 4800, 2400

- 4 Use the cursor button (▲ or ▼) to move the cursor to **TERMINATE**, and then use the cursor button (◀ or ▶) to select the terminate setting.

 To close the menu screen or return to the previous screen, select **BACK** or **END** for **MENU** and press the **SET** button.

OPTION SETTING

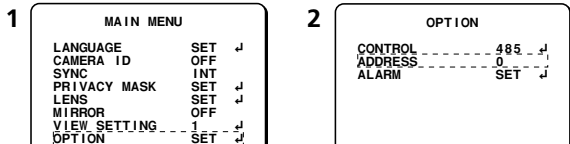

■ ADDRESS setting

- 1 Use the cursor button (▲ or ▼) to move the cursor to **OPTION**, then press the **SET** button.

The OPTION screen will appear.

Note: The PRESET ON setting cannot be used when OPTION settings are in use.

- 2 Use the cursor button (▲ or ▼) to move the cursor to **ADDRESS**, and then use the cursor button (◀ or ▶) to select the address.

Available settings: 0 (◀) ~ 127 (▶)

- ☞ To close the menu screen or return to the previous screen, select **BACK** or **END** for **MENU** and press the **SET** button.

■ ALARM setting

Ⓐ Alarm input setting (ALARM IN)

Make the following settings for alarm detection.

Connect the external alarm switch to the alarm input terminal on the back of the camera.

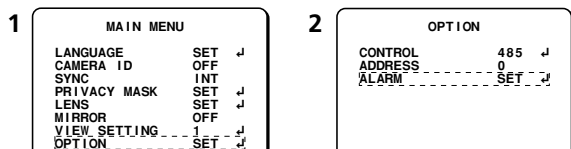

- 1 Use the cursor button (▲ or ▼) to move the cursor to **OPTION**, then press the **SET** button.

The OPTION screen will appear.

Note: The PRESET ON setting cannot be used when OPTION settings are in use.

- 2 Use the cursor button (▲ or ▼) to move the cursor to **ALARM**, then press the **SET** button.

The ALARM SETTING screen will appear.

- 3 Use the cursor button (◀ or ▶) to select **POLARITY** between "NO" and "NC".

Available settings:

- **NO:** Normal open (Normally open so closed condition is detected as input.)
- **NC:** Normal closed (Normally closed so open condition is detected as input.)

OPTION SETTING

3

ALARM SETTING	
ALARM IN	NO
POLARITY	OFF
MOTION	OFF
DURATION	5S
ALARM OUT	OFF
POLARITY	NO
ALARM TIME	5S
LINE OUT	OFF

■ Motion sensor input setting (MOTION)

Matches information from the camera's motion sensor and the external alarm and outputs it.

Use the cursor button (▲ or ▼) to move the cursor to **MOTION**, then use the cursor button (◀ or ▶) to select the input.

Available settings:

- **OFF:** Does not output a motion sensor alarm.
- **AND:** Outputs an alarm when an external alarm input and motion sensor alarm are detected at the same time.
- **OR:** Outputs an alarm if either an external alarm or a motion sensor alarm is detected.

■ Alarm duration setting (DURATION)

Set the duration for the following alarm input reception.

Use the cursor button (▲ or ▼) to move the cursor to **DURATION**, then use the cursor button (◀ or ▶) to select the alarm duration.

Available settings: 5S, 10S, 15S, 20S, 30S, 1M, 2M, 3M, 4M, 5M

🔍 To close the menu screen or return to the previous screen, select **BACK** or **END** for **MENU** and press the **SET** button.

OPTION SETTING

B Alarm output setting (ALARM OUT)



1 Use the cursor button (▲ or ▼) to move the cursor to **ALARM OUT**, then use the cursor button (◀ or ▶) to select the "ON" or "OFF".

Available settings:

- **ON:** Output an alarm (for activation of buzzer or lamp)
- **OFF:** Does not output an alarm

2 Use the cursor button (▲ or ▼) to move the cursor to **POLARITY**, then use the cursor button (◀ or ▶) to select the "NO" or "NC".

Available settings:

- **NO:** Normal open (Normally open so closed condition is detected as input.)
- **NC:** Normal closed (Normally closed so open condition is detected as input.)

3 Use the cursor button (▲ or ▼) to move the cursor to **ALARM TIME**, then use the cursor button (◀ or ▶) to select the amount of time for external alarm output.

Available settings: 5S, 10S, 15S, 20S, 30S, 1M, 2M, 3M, 4M, 5M

☰ To close the menu screen or return to the previous screen, select **BACK** or **END** for **MENU** and press the **SET** button.

OPTION SETTING

③ Operation of alarm signal output to the System Controller setting (LINE OUT)

Outputs alarm signal to the System Controller. The ALARM lamp on the System Controller will blink when it receives an alarm signal. An alarm list can be displayed to show information such as date/time alarm was received, the device sending the alarm and the alarm type.

1

ALARM SETTING	
ALARM IN	NO
POLARITY	OFF
MOTION	OFF
DURATION	5S
ALARM OUT	OFF
POLARITY	NO
ALARM TIME	5S
LINE OUT	OFF

Use the cursor button (▲ or ▼) to move the cursor to **LINE OUT**, then use the cursor button (◀ or ▶) to select the "ON" or "OFF".

Available settings:

- **ON:** Outputs alarm signal to the System Controller
- **OFF:** Does not output alarm signal to the System Controller

🔍 To close the menu screen or return to the previous screen, select **BACK** or **END** for **MENU** and press the **SET** button.

MENU FLOW

English

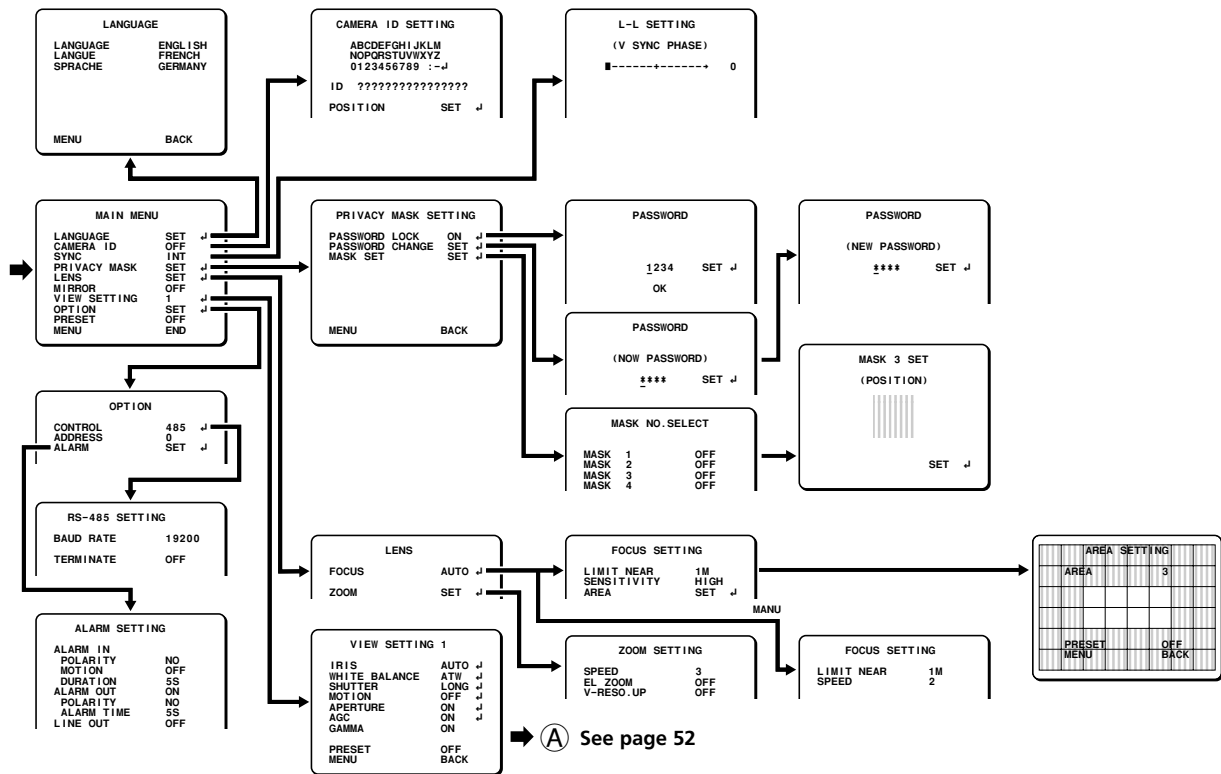

Ⓐ See page 52

MENU FLOW

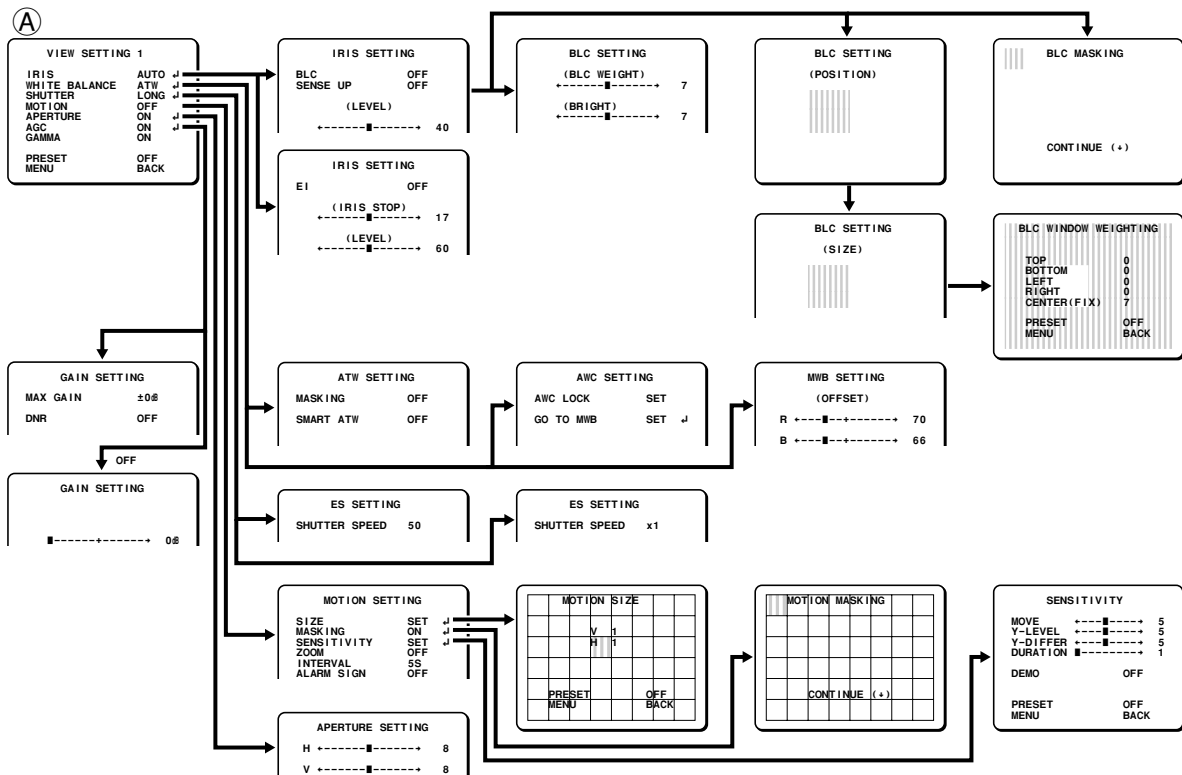

SPECIFICATIONS

Pickup device	: 1/4"
Effective pixels	: 752 (H) x 582 (V)
Horizontal resolution	: Over 520 TV lines
Lens	: 22 power zoom lens, f=4.0 – 8.8mm (F1.6 – 3.8) Electronic zoom and gearing Zoom speed setting possible
Electronic zoom	: 16 power (combined with optic zoom gives 352 power max) Max zoom magnification setting possible Vertical resolution ON/OFF setting
Autofocus	: AUTO/MANUAL AF area setting possible (3 step)
Iris control	: AUTO/MANUAL, 1/2 EV steps
Synchronization method	: Internal synchronization/Line lock, V phase adjustment possible
Lowest image illumination	: 2.0 lx (F1.6) at max AGC gain 0.06 lx (F1.6) at x32 electronic sensitivity boost
S/N	: Over 48dB
Backlight compensation	: Multi-spot evaluative metering 5 spot centerweighted average metering 48 multi-spot metering
Electronic shutter	: • Fast shutter speed mode (SHORT); 1/50, 1/120, 1/250, 1/500, 1/1000, 1/2000, 1/4000, 1/10000 • Slow shutter speed mode (LONG); x1, x2, x4, x8, x16, x32
Electronic sensitivity boosting	: AUTO/OFF, works with auto iris Up to x32 max setting possible
White balance	: ATW/AWC/MWB
AGC gain	: ON allows selection of ± 0 dB, +6dB, +9dB, -6dB OFF allows manual adjustment from 0dB to 30dB

Motion detector	: ON/OFF, ON allows setting of detection patterns on a 48 zone screen for 6 motion settings (size, masking, sensitivity, zoom, interval, alarm sign)
Privacy masking	: ON/OFF, max of 4 masked locations Password lock possible
Alarm input/output (back panel control terminals)	: Alarm input: 1 (for external alarm switch) Alarm output: 1 (for sending a signal to the system controller or an alarm detection device such as a buzzer)
Mirror image effect	: Horizontally (H), vertically (V), horizontally and vertically (HV)
Camera ID	: ON/OFF, 16 characters
View settings	: 9 (0 – 8) screen files can be established, and each file can set 7 capturing characteristics such as iris
Communications	: Coaxial control, RS-485
Operational temperature/humidity	: -10 – 50°C/below 90% RH
Power source	: 24 V AC, 50 Hz/12 V DC
Power consumption	: 4.5 W
Weight	: 380 g

SPECIFICATIONS

■ Dimensions

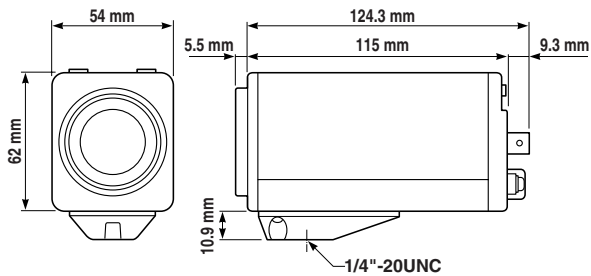

External appearance and specifications subject to change without notice.