

TOSHIBA

Leading Innovation >>>

OWNER'S MANUAL

Integrated Digital LCD TV

 DOLBY
DIGITAL

 DVB[®]

 HDMI

26AV500A

32AV500A

37AV500A

42AV500A

Owner's Record

You will find the model number and serial number on the back of the TV. Record these numbers in the spaces provided below. Refer to them whenever you call upon your TOSHIBA dealer regarding this product.

Model number:

Serial number:

DVB registration identification reference number: 5588 (26AV500A), 5589 (32AV500A), 5590 (37AV500A), 5591 (42AV500A).

Trademark of the DVB – Digital Video Broadcasting Project

© 2008 TOSHIBA CORPORATION

All Rights Reserved

VX3A00025000

HDA51V3220I

Contents

Introduction

Welcome to Toshiba	3
Important Safety Instructions	3
Installation.....	3
Use	4
Service.....	5
Cleaning	6
Important information	6

Getting started

Connecting an antenna	7
Exploring your new TV	7
Installing the remote control batteries.....	7
TV front, control and side panel	8
TV back panel connections	9
Learning about the remote control	10
Location of controls	10
Learning about the menu system.....	11
Displaying the Digital TV/Analog TV SETUP menu chart	11
Turning the TV on.....	12
Switching on the TV	12
Switching off the TV	12
Tuning the TV for the first time	13
Programming channels into the TV's channel memory ...	13
Full Search - digital only -	13
Manual Search - digital only -	14
Auto Tuning - analog only -	14
Manual Adjust - analog only -	15
Channel List - digital only	15
Sorting program position	15
Favorite Channel	16
Channel List - analog only -	16
Watching TV programs	17
Viewing Digital programs - digital only -	17
Switching between two program positions	17
Selecting the menu language	17
Displaying the on-screen information.....	17
Setting the On-Screen-Display Time	17

Using the TV's features (General)

Picture adjustment	18
Selecting the picture size.....	18
Using the picture still	19
Adjusting the picture position - PC only -	19
Automatically Adjusting the picture position - PC only -	19
Selecting the picture mode.....	19
Adjusting the basic picture quality	19
Activating the DNR (Digital Noise Reduction)	20
Selecting the color temperature.....	20
Using the active backlight control.....	20
Using the cinema mode - except digital, analog, PC -	20
Sound adjustment	21
Setting the MTS (Multi-channel TV Sound) - analog only -	21
Selecting the dual 1 or dual 2 mode- analog only -	21
Selecting the stereo programs - analog only -	21
Selecting the bilingual programs - analog only -	21
Adjusting the sound quality	21
Using the Bass Boost	22
The timers.....	22
Setting the Current Time	22
Setting the Wakeup Timer	22
Setting the Sleep Timer	22
Setting the Power Control	22
Setting the Banner Duration - digital / analog -	23
Selecting the video input source to view.....	23
Teletext in Analog TV	23

Setting up the teletext mode.....	23
Teletext general information	23
Using Auto mode	24
Using LIST mode	24
Teletext buttons on the remote control.....	24
Teletext in Digital TV.....	25
Reset all default setting	25

Other Digital TV features and settings

Setting the EPG (Electronic Program guide) - digital only -	26
Password.....	26
Setting the Password	26
Parental Rating	26
Setting the Parental Rating.....	26
AV Connection	27
Subtitle	27
Audio Preference	27
Selecting The Audio Mode	27
Digital Output Format	27

Connecting your TV

Back connections.....	28
Connection example.....	28
Connecting an audio system - digital only -	28
Connecting an amplifier equipped with a Dolby Digital decoder.....	28
Connecting an amplifier equipped with an MPEG decoder.....	29
Connecting an amplifier equipped with a digital audio (optical or coaxial) input	29
Side connections.....	29
Connection example.....	29
Connecting an HDMI or a DVI device.....	29
Connecting an HDMI or a DVI device.....	29
Connecting an HDMI device	30
Connecting a DVI device	30
Connecting a computer.....	30
Using the PC setting	31
Adjusting the picture size/position, the clock phase of the picture and sampling clock	31
PC of the Auto Adjust	31

Reference section

Troubleshooting.....	32
Symptom and solution	32
Symptom and solution - digital only -	32
APPENDIX	33
AUSTRALIAN PARENTAL GUIDANCE CODES (Normative).....	33
Broadcast system.....	34
Broadcast transmission systems of each country or region	34
Specifications	34

Introduction

Welcome to Toshiba

- Thank you for purchasing this Toshiba LCD Color television. This manual will help you use the exciting features of your new TV.
- Instructions in this manual are based on using the remote control.
- Please read all safety and operating instructions in this manual carefully, and keep this manual for future reference.

Important Safety Instructions

Be sure to observe the following instructions and precautions to ensure safe use of this TV.

Installation

- 1) **Always connect the power plug to an appropriate electrical outlet equipped with 220-240V, AC 50Hz.** Never use the TV outside the specified voltage range. It may cause a fire or an electric shock.

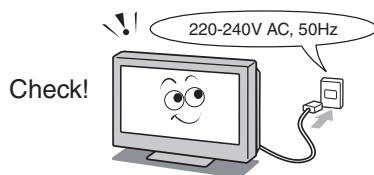

- 2) **Never insert or remove the power plug with wet hands.** This may cause an electric shock.

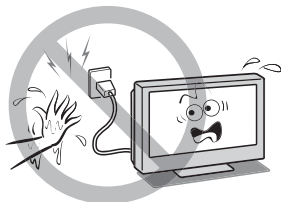

- 3) **Never place the TV in an unbalanced location such as on a shaky table, incline or location subject to vibration.** The TV may drop or fall off which may cause injury or damage.

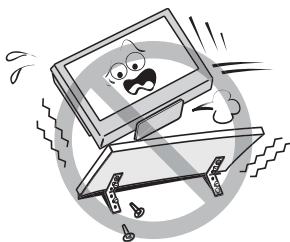

- 4) **Never block or cover the slots and openings in the cabinet.**
 - Never place the TV so that it is facing upward or on its side.
 - Never place the TV in a closet, bookcase or other similar area where the ventilation is poor.
 - Never drape a newspaper, tablecloth or curtain on the TV.
 - When installing the TV against a wall, always keep the TV at least 10 cm away from the wall.
 - Never place the TV on a soft unstable surface, such as a carpet, or a cushion.

The inside of this TV will overheat if the ventilation holes are covered, blocked or sealed, which may result in a fire.

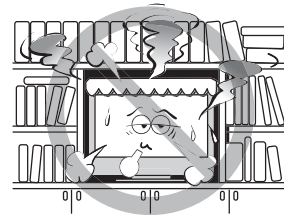

- 5) **Never place the TV near a heater or in direct sunlight.** The surface of the cabinet or power cord may melt and result in a fire or an electric shock.



- 6) **Never place the TV in an area exposed to high humidity levels, such as in a bathroom or close to a humidifier.** This may cause a fire or an electric shock.

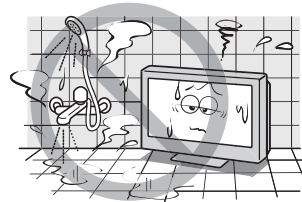

- 7) **Never place the TV next to a stove where it will be exposed to oil, smoke, or steam, or in a location where there is a large quantity of dust.** This may cause a fire or an electric shock.



- 8) Always place the TV on the floor or a sturdy, level, stable surface that can support the weight of the unit. To secure the TV, use a sturdy strap from the hooks on the rear of the TV to a wall stud, pillar, or other immovable structure. Make sure the strap is tight, secure, and parallel to the floor.

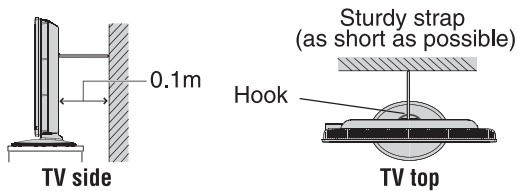

9) Precautions for moving the TV

- When moving the TV, be sure to remove the plug from the wall outlet and disconnect the antenna cable and audio/video cables, any steady ties. Fire or electric shock may result if the power cord is damaged.
- When carrying the TV, at least two people are needed. Be sure to carry it upright.
- Never carry the TV with the screen facing up or down.

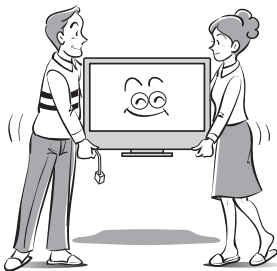

10) Precautions for installing on outdoor antenna

An outside antenna system should not be located in the vicinity of overhead power lines, or other electric light or power circuits. If the antenna falls down or drops, it may cause injury or electric shock.



Use

- 1) Never place hot objects or open flame sources, such as lighted candles or nightlights, on or close to the TV.

High temperatures can melt plastic and lead to fires.

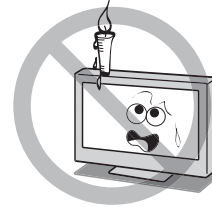

- 2) The apparatus shall not be exposed to dripping or splashing and that no objects filled with liquids, such as vases, shall be placed on the apparatus.

When liquids are spilled or small items are dropped inside the TV, this may cause a fire or an electric shock. If small objects drop inside the TV, turn off the TV and remove the power plug from the outlet immediately and contact a service technician.



- 3) Never insert objects (metal or paper) or pour water inside the TV through ventilation holes and other openings.

These items may cause a fire or an electric shock. If these objects are inserted inside the TV, turn off the TV and remove the power plug from the outlet immediately and contact a service technician. Be especially careful that children do not insert objects into the TV.



- 4) Never stand or climb on the TV.

Be especially careful in households with children to prevent them through climbing on top of the TV. It may move, fall over, break, become damaged or cause an injury.



5) **When the TV will not be used for a long period of time, such as during vacation or travel, remove the power plug from the wall outlet for safety.**

- The TV is not completely disconnected from the power supply line, as minute current is consumed even when the \odot / Power switch is turned off.
- The Mains plug or an appliance coupler is used as the disconnect device, therefore the disconnect device shall remain readily operable.

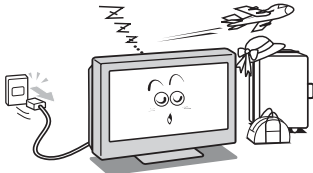

6) **Never pull on the power cord when removing the plug from the wall outlet.**

Always hold the plug firmly when removing it. If the power cord is yanked, the cord may become damaged and a fire or an electric shock may occur.

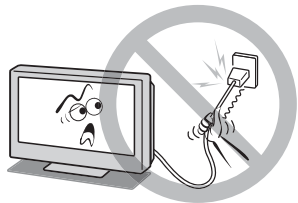

7) **Never cut, break, modify, twist, bunch up or bend the cord or apply excessive force or tension to it.** Never place heavy objects on the cord or allow it to overheat as this may cause damage, a fire or an electric shock. Contact a service technician if the power cord is damaged.

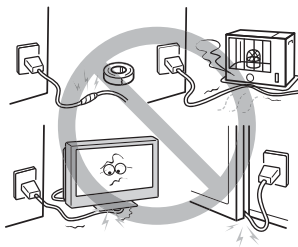

8) **If there is thunder or lightning, never touch the antenna cable or other connected cables.** You may suffer an electric shock.



Service

1) **Never repair, modify or disassemble the TV by yourself.**

It may cause a fire or an electric shock. Consult a service technician for inspection and repairs.



2) **When a malfunction occurs, or if smoke or an unusual odour comes from the TV, turn off the TV and remove the power plug from the outlet immediately.**

Make sure that the smoke or smell has stopped, then contact a service technician. If the TV is still used in this condition, it may cause a fire or an electric shock.

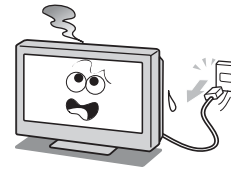

3) **If the TV is dropped or the cabinet is broken, turn off the TV and remove the power plug from the outlet immediately.**

If the TV is still power used in this condition, it may cause a fire or an electric shock. If the cabinet is broken, be careful when handling the TV to prevent an injury. Contact a service technician for inspection and repair.

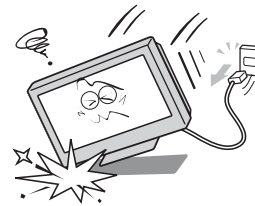

4) **When the TV reaches the end of its useful life, ask a qualified service technician to properly dispose of the TV.**

Note:

The lamp unit contains a small amount of mercury. Disposal of mercury may be regulated due to environmental considerations.

Dispose of the used lamp unit by the approved method for your area. For disposal or recycling information, please contact your local authorities.

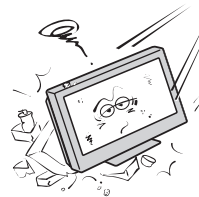

Cleaning

1) Remove the power plug before cleaning.

Never use solvents such as benzene or thinner to clean the TV.

- These solvents may distort the cabinet or damage its finish.
- If rubber or vinyl products remain in contact with the TV for a long time, a stain may result.

If the cabinet becomes dirty, clean it with a soft, dry cloth.

When cleaning the surface of the LCD display, wipe the panel surface gently with a soft, dry cloth.

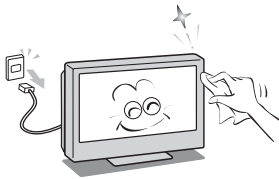

2) Periodically disconnect the power plug from the outlet and check it. If dust has collected on the power plug connectors, clean off the dust with dry cloth.

This dust may cause a fire due to reduced insulation on the plug.



Important information

1) About LCD screen

- If you have the LCD screen facing to the sun, the LCD screen will be damaged. Be aware of locating the TV in the place such as window side or outside of the room.
- Never press the LCD screen strongly or scratch it, and never put anything on it. These actions will damage the LCD screen.

2) About cabinet and LCD screen

Never spray volatile compounds such as insecticide on the cabinet and LCD screen.

This may cause a discoloration or damage the cabinet and LCD screen.

3) Some pixels of the screen do not light up

The LCD display panel is manufactured using an extremely high level of precision technology, however sometimes some pixels of the screen may be missing picture elements or have luminous spots. This is not a sign of a malfunction.

4) About Interference

The LCD display may cause interference in image, sound, etc. of other electronic equipment that receives electromagnetic waves (e.g. AM radios and video equipment).

5) About using under the low temperature places

If you use the TV in the room of 0°C or less, the picture brightness may vary until the LCD monitor warms up. This is not a sign of a malfunction.

6) About afterimage

If a still picture is displayed, an afterimage may remain on the screen, however it will disappear. This is not a sign of malfunction.

Exemptions

- Toshiba is not liable for any damage caused by fires, natural disaster (such as thunder, earthquake, etc.), acts by third parties, accidents, owner's misuse, or uses in other improper conditions.
- Toshiba is not liable for incidental damages (such as profit loss or interruption in business, modification or erasure of record data, etc.) caused by use or inability to use of product.
- Toshiba is not liable for any damage caused by neglect of the instructions described in the owner's manual.
- Toshiba is not liable for any damage caused by misuse or malfunction through simultaneous use of this product and the connected equipment.

Getting started

Connecting an antenna

Optimum reception of color requires a good signal and will generally mean that an outdoor antenna must be used.

The exact type and positioning of the antenna will depend upon your particular area.

Your Toshiba dealer or service personnel can best advise you on which antenna to use in your area.

Before connecting the antenna cable, turn off all main power switches.

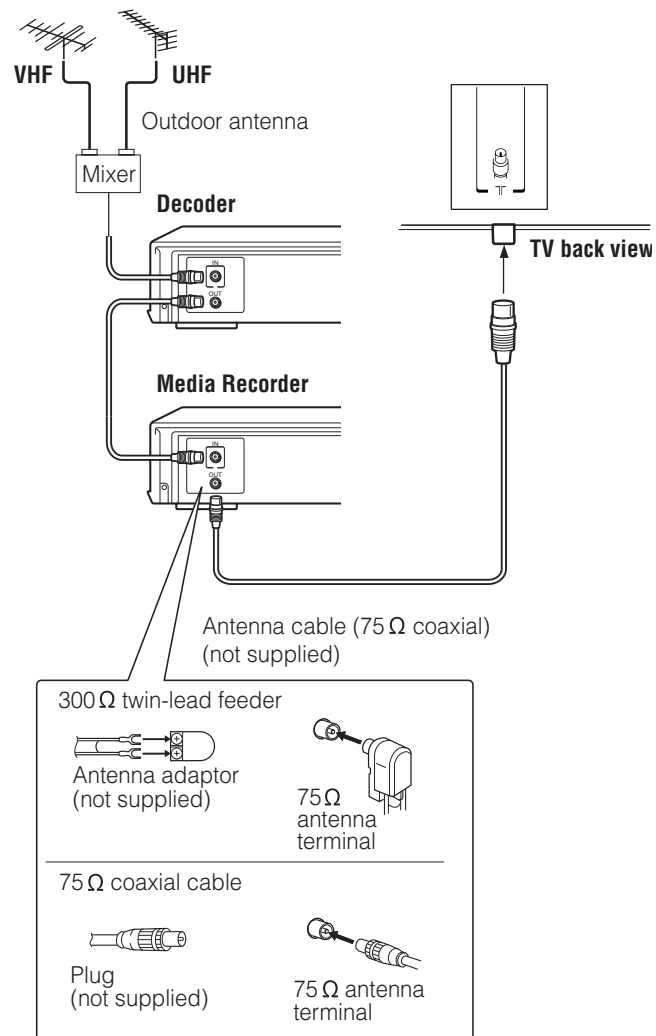

Exploring your new TV

Installing the remote control batteries

Remove the battery cover.

Insert two R03 (AAA) batteries matching the -/+ polarities of the battery to the -/+ marks inside the battery compartment.

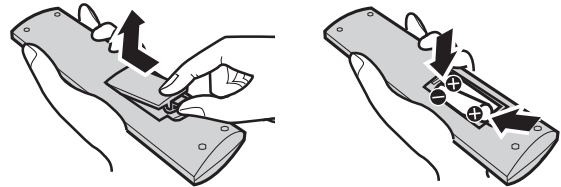

Cautions:

- Dispose of batteries in a designated disposal area. Never throw batteries into a fire.
- Attention should be drawn to the environmental aspects of battery disposal.
- Never mix battery types or combine used batteries with new ones.

Notes:

- If the remote control does not operate correctly, or if the operating range becomes reduced, replace both batteries with new ones.
- If the batteries are dead or if you will not use the remote control for a long time, remove the batteries to prevent battery acid from leaking into the battery compartment.

Effective range

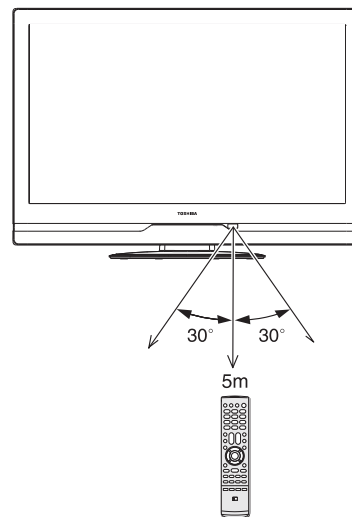

TV front, control and side panel

- You can operate your TV using the buttons on the TV control panel or the remote control. The back and side of the panel provide the terminal connections to connect other equipment to your TV (- “Connecting your TV” pages 29 - 32).
- For the use of each control, see the pages in brackets.

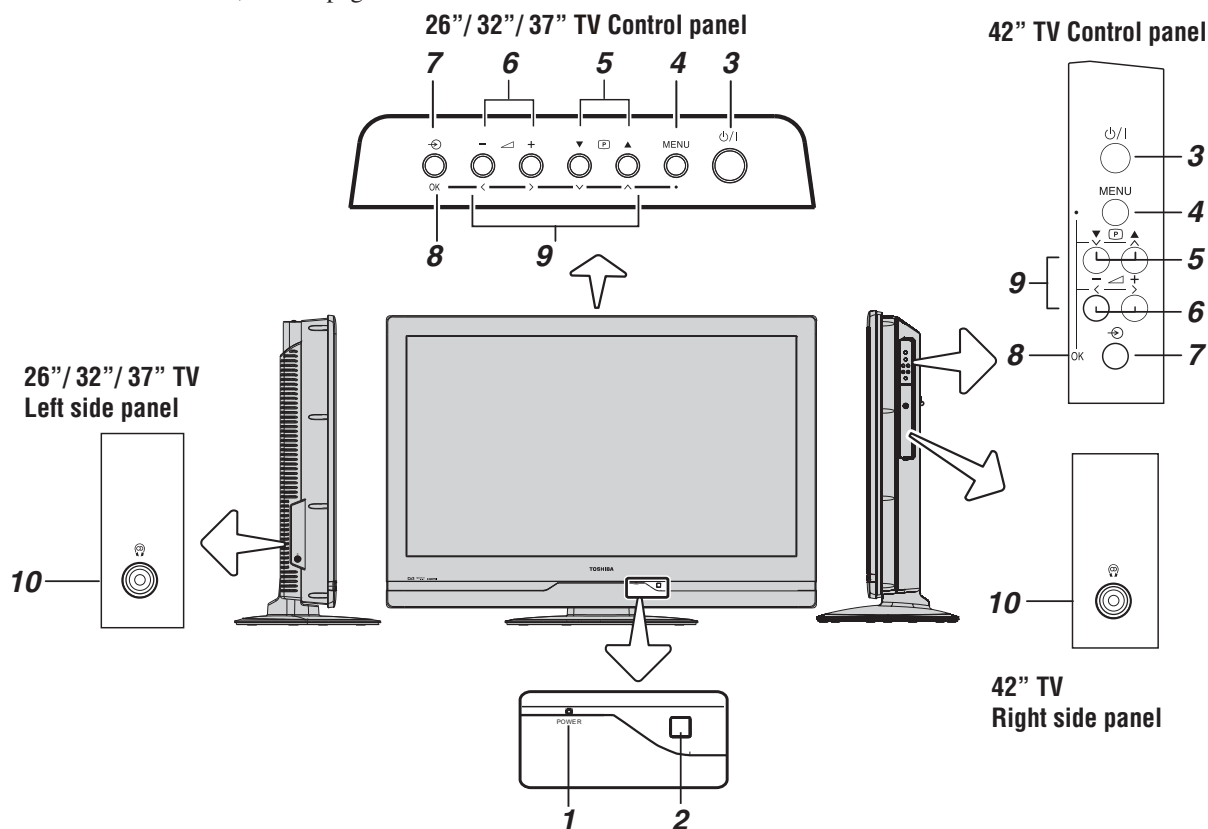

- 1** **⏻ (Power LED)** — Power indicator (see page 12).
- 2** **(Remote sensor)** — Point the remote control toward this remote sensor (see page 7).
- 3** **⏻ (Power on/Standby)** — Press to turn the TV on/standby (see page 12).
- 4** **MENU** — Press to access the TV SETUP menu (see page 11, 12).
- 5** **⏻▲▼ (Program position)** — When no menu is on-screen, these buttons select the program position. (see page 16).
- 6** **◀ - + (Volume)** — When no menu is on-screen, these buttons adjust the volume level (see page 10).

- 7** **⊗ (Input source selection)** — When no menu is on-screen, this button selects the input source (see page 23).
- 8** **OK** — When a TV menu is on-screen, this button functions as the next menu navigation button (see page 11).
- 9** **▲▼<> (Arrows)** — When a TV menu is on-screen, these buttons function as up/down/left/right menu navigation buttons or adjust settings (see page 11).
- 10** **🎧 (Headphone jack)** — For use with headphones.

Note:

When the Headphone jack is being used, the sound from all speakers will be muted, and normal sound will be output to the headphones only.

TV back panel connections

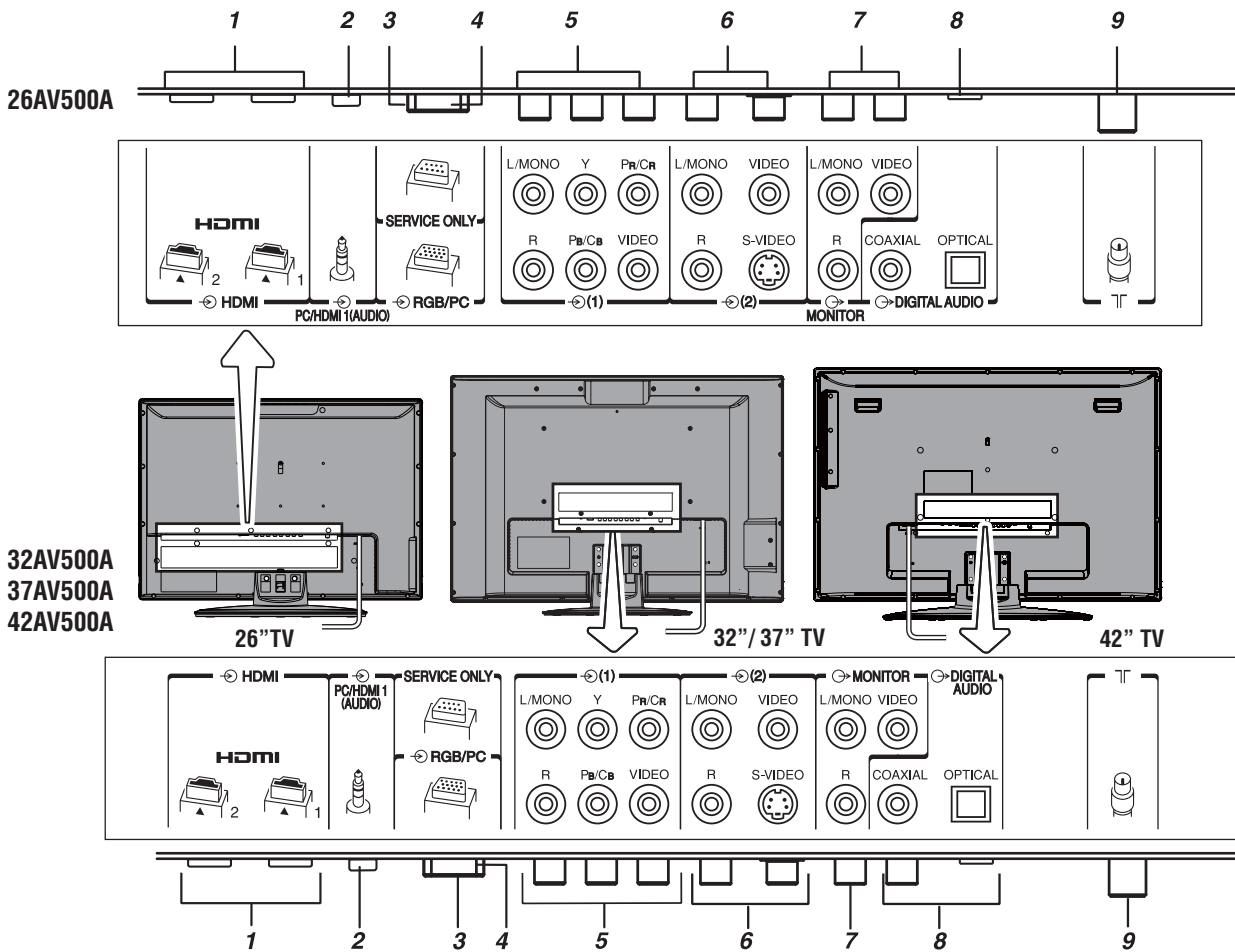

- 1** **HDMI1,2 (input terminals)** — High-Definition Multimedia Interface input receives digital audio and uncompressed digital video from an HDMI device or uncompressed digital video from a DVI device (see page 29).
- 2** **PC/HDMI 1 (AUDIO) (input terminals)** — For use when connecting a personal computer (PC) or a DVI device with standard audio output (see page 28, 30).
- 3** **RGB/PC (input terminal)** — For use when connecting a personal computer (PC) (see page 30).
- 4** **Service** — For service use only.
- 5** **(1) (Video 1 input terminals)** — High-definition component video or standard (composite) video and standard (analog) stereo audio inputs (see page 28).

- 6** **(2)(Video 2 input terminals)** — Standard (composite) video and standard audio inputs plus optional S-video inputs for connecting devices with composite video or S-video output.
- 7** **MONITOR (output terminals)** — For use when connecting a VCR/HDD/DVD video recorder with standard video and standard audio inputs (see page 28).
- 8** **DIGITAL AUDIO (coaxial/optical) (output terminal)** — For use when connecting an amplifier with coaxial or optical type digital audio input (see page 28).
- 9** **(Antenna input terminal)** — Analog TV/Digital DVB-T antenna signal input (see page 7).

Learning about the remote control

Location of controls

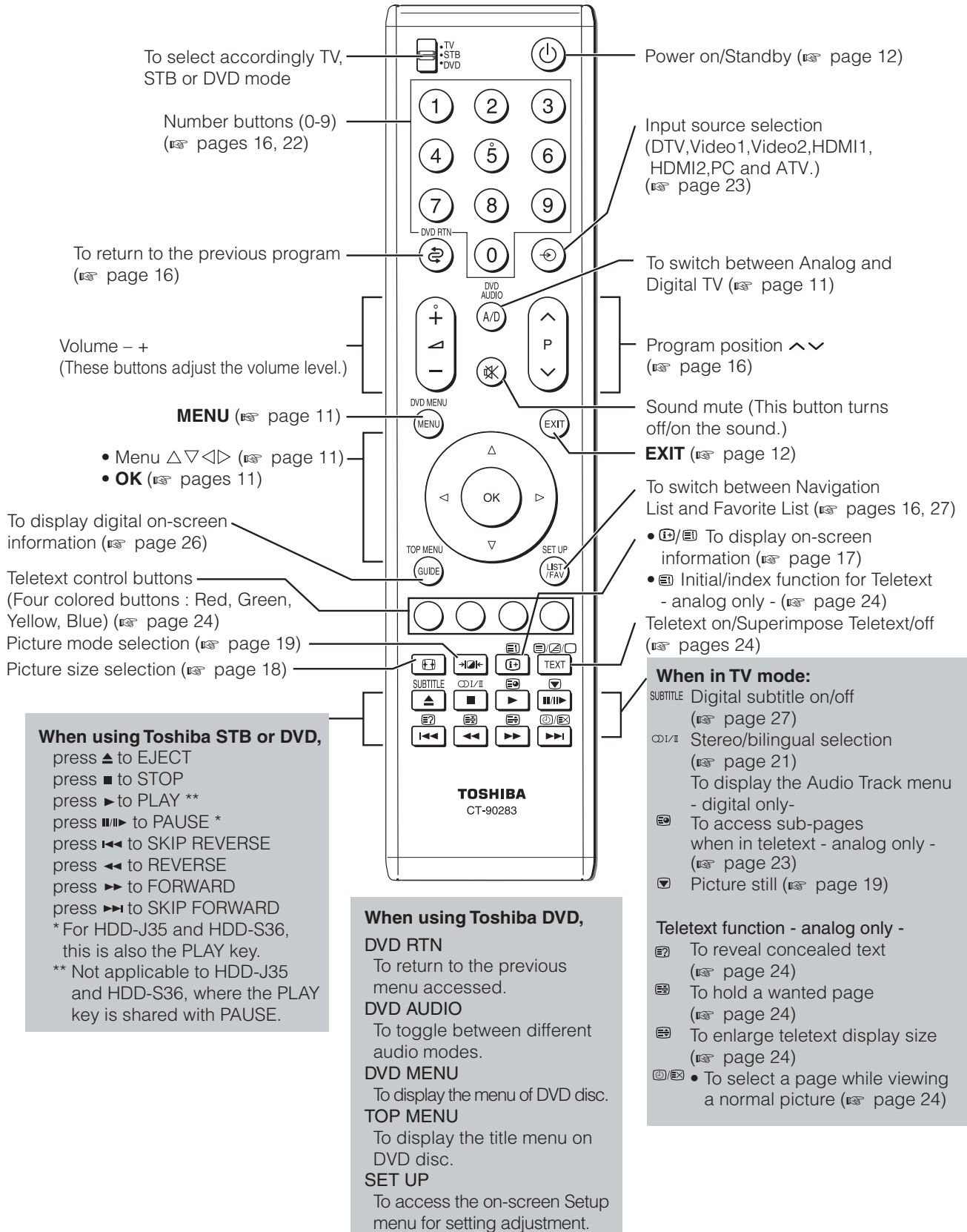

This integrated TV is equipped with both Digital and Analog system. To switch between Digital and Analog TV press **A/D** on the remote control.

Learning about the menu system

We suggest you familiarize yourself with the display charts before using the menu system:

- Press **MENU** to display menu, then press **◀** or **▶** to select main menu headings.
- Press **△** or **▽** to select sub menu headings.
- Press **OK** to select or adjust setting.
- Press **OK** to display the next menu.

Displaying the Digital TV/Analog TV SETUP menu chart

When source input "DTV" or "ATV" is selected, press **MENU** to display the TV SETUP menu chart. The menu will display "DTV Menu" if Digital TV selected. The menu will display "ATV Menu" if Analog TV selected. There will be some functions which not available in Digital TV.

TV SETUP menu chart

About DTV Menu

PICTURE menu

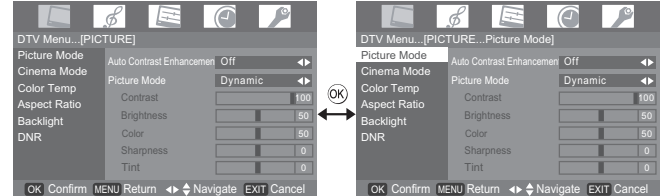

SOUND menu

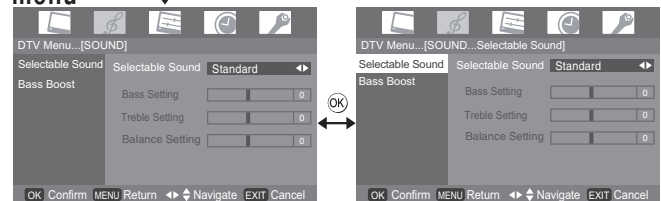

SET UP menu

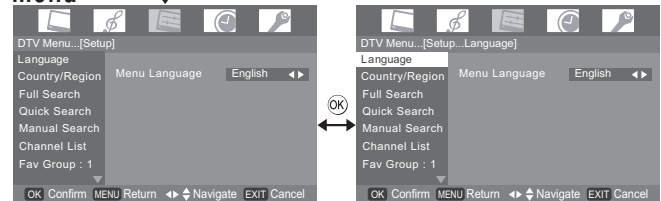

TIMER menu

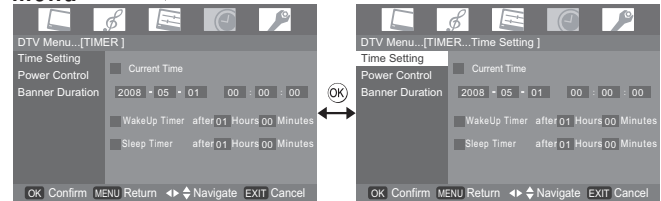

FUNCTION menu

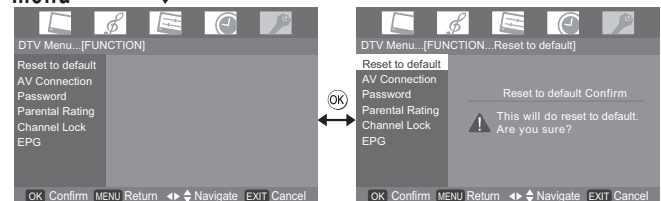

About ATV Menu

PICTURE menu

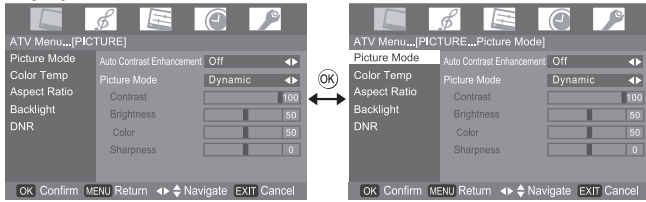

SOUND menu

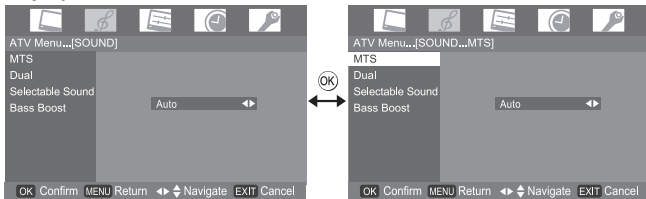

SET UP menu

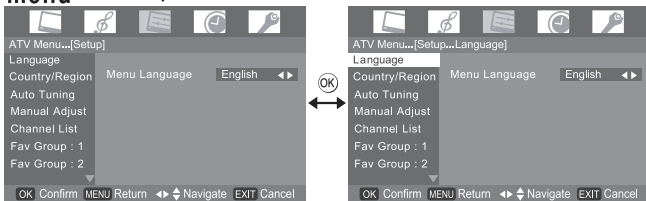

TIMER menu

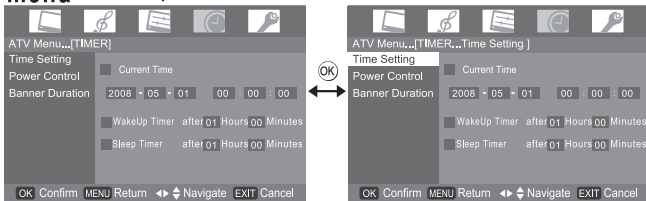

FUNCTION menu

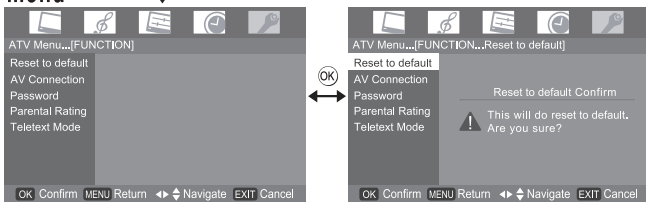

Notes for menu system:

- In the video input mode (**Video1**, **Video2**, **HDMI**, **PC**), **Auto tuning / Full Search** and **Manual Adjust / Manual Search** are not available. (see page 26).
- If you do not make a selection for a while, the menu display disappears automatically.
- If you want to close the menu display instantly, press **EXIT**.

Turning the TV on

Switching on the TV

Connect the power cord to a wall outlet, the **⏻** / **I** power indicator lights in red (standby mode).

- 1 Press **⏻** on the remote control or **⏻** / **I** on the TV control panel, the **⏻** / **I** power indicator lights in green.

Switching off the TV

- 1 Press **⏻** on the remote control or **⏻** / **I** on the TV control panel to switch to the standby mode.

Notes:

- This TV is not fully disconnected from the main supply, as minute current is consumed even when **⏻** / **I** is turned off. When the TV will not be used for a long period of time, such as during vacation or travel, remove the power plug from the wall outlet.
- If power is cut off while you are viewing the TV, the Last Mode Memory function turns on the TV automatically when power is applied again. If power is going to be off for a long time and you are going to be away from your TV, unplug the power cord to prevent the TV from turning on in your absence.

Tuning the TV for the first time

Before switching on the TV, put your decoder and media recorder to Standby if they are connected and ensure the antenna is connected. To setup the TV use the buttons on the remote control as detailed on page 10.

- 1 This screen will appear the first time that the TV is switched on and each time the TV is reset.

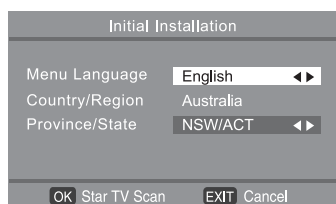

- 2 Press ◀ or ▶ to select the **Menu Language** function. Language include the **English, Français** and **中文**.
- 3 Use ▼ to select **Province/State**. Press ◀ or ▶ to select the state in which you live. State include the NSW/ACT(New South Wales/Australian Capital Territory), VIC(Victoria), QLD(Queensland), SA(South Australia), WA(Western Australia), TAS(Tasmania) and NT(Northern Territory)
- 4 Press **OK** to start ATV/DTV Scan. The Auto Scan screen will appear and the TV will automatically start to search for available stations. The progress bar will move along the line.

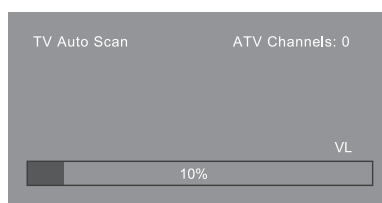

- 5 When DTV search is completed, the TV will automatically turn to the lowest logical channel number.

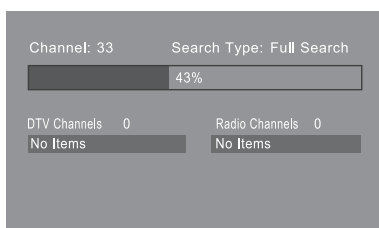

Programming channels into the TV's channel memory

Full Search - digital only -

As new services are broadcast, it will be necessary to re-tune the TV in order to view them.

Full Search will completely re-tune the TV and can be used to update the channel list. It is recommended that Full Search is run periodically to ensure that all new services are added. All stored programs and settings, including Timer entries, favorites and locked programs, will be lost.

- 1 Press **MENU**, and ◀ or ▶ to select the **SETUP** menu.
- 2 Press **OK** and ▲ or ▼ to select **Full Search** menu.
- 3 Press **OK**, a confirmation screen will appear indicating that **This will do full search, Are you sure?**

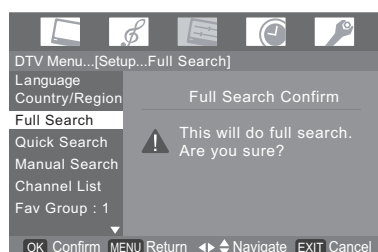

- 4 Press **OK**, to start Auto tuning. The below sample display shows **Full Search** in progress. The channel number will show 1~ 69.

DTV Channels will display searched channel and name information.

Radio Channels will display searched channel and name information.

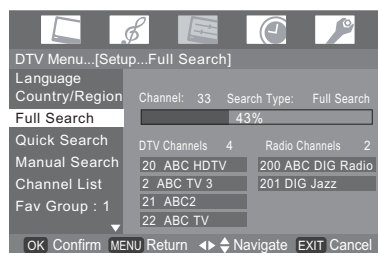

- 5 **Full Search** will show scan of **DTV Channels /Radio Channels** list.
- 6 When the search is complete, the TV will automatically tune to the lowest logical channel number.

Note:

After the **Full Search**, the TV may have scanned identical channels being broadcast from different transmitters. Pressing **OK** or **GUIDE** helps you to check **Full Search** result. If you do find channels with the same logical channel numbers but different physical channel numbers, it is recommended that you skip these duplicate channels and keep only one channel with the best signal strength as indicated by the signal strength bar in the on-screen information.

Manual Search - digital only -

If there were any missing channel after **Full Search**, these channels might be found by using **Manual Search** described in this section.

- 1 From the **Setup** menu, press ∇ or \triangle to select **Manual Search**.
- 2 Press OK , then press \triangleleft or \triangleright to select the channel(0~69) you wish to search.

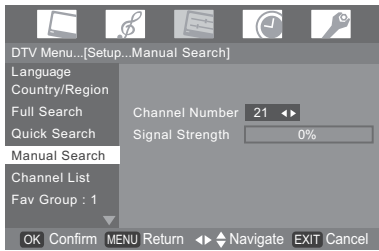

- 3 If scanning was successful, **Signal Strength** will appear at almost 100%. Repeat to scan other channels as necessary.

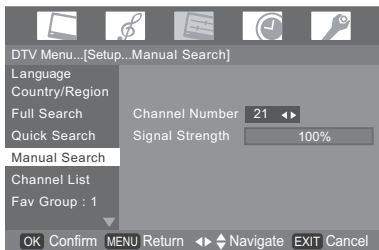

- 4 If scanning was unsuccessful, **Signal Strength** will appear at almost 0%.
At this point you can rescan the signal or refer to aligning the direction of the antenna to get the signal. Refer to your antenna installer if problem persists.

Notes:

- **Signal Strength** refers to the input Radio Frequency (RF) signal strength as perceived by the TV. Note that too strong signal may cause erroneous readings. If you use an antenna booster and find that you still get a low signal level, your booster gain may be set too high. In this case, adjust the gain accordingly. You may also see the **No Signal** on the screen when the signal level is low.

Auto Tuning - analog only -

First, use the **Auto Tuning** function to preset all the active channels in your area automatically. Then, arrange the preset channels with the **Manual Adjust** function so that you can tune into desired channels.

- 1 Press MENU , and \triangleleft or \triangleright to select the **Setup** menu.
- 2 Press OK and \triangle or ∇ to select **Auto Tuning** menu.
- 3 Press OK , a confirmation screen will appear indicating that **This will do auto tuning, Are you sure?**

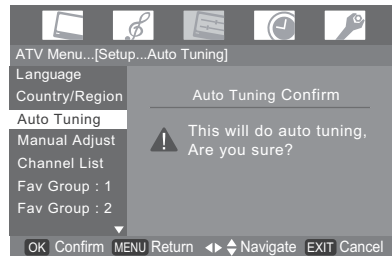

- 4 Press OK to start the automatic search.
The search will begin for all available stations.

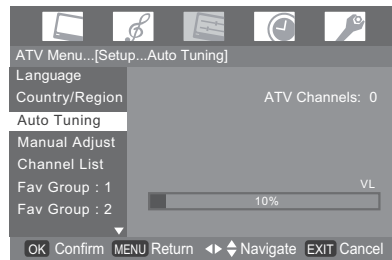

The slide bar will move along line as the search progresses.

If you make a mistake, simply repeat steps 1-3 to start again from the beginning.

- 5 When the automatic search is completed, the TV will automatically return to the first program position.
- 6 Press $\text{P}\wedge$ or $\text{P}\vee$ to view the programmed position.

Note:

When you preset the program channel which sound of broadcast transmission system adopts "M" system, the sound system may not be tuned correctly if the radio waves transmit badly. At that time, preset the channel by **Manual Search**.

Manual Adjust - analog only -

Use the **Manual Adjust** operation if desired channels cannot be preset with the Auto tuning or if you would like to preset channels to specific position numbers one by one.

- From the **SET UP** menu, press ∇ or \triangle to select **Manual Adjust**.

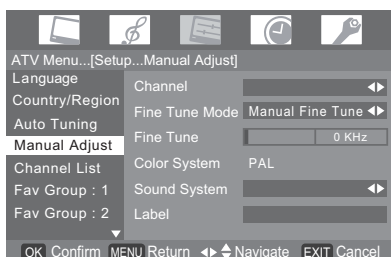

- Press \odot to display the **Manual Adjust** menu, then press ∇ or \triangle to select the item as shown below.

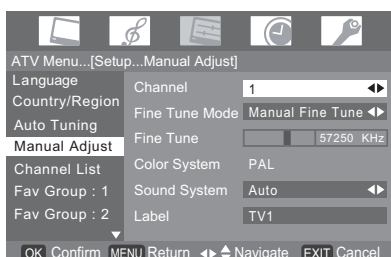

A. Channel

You can select channel no for which **Manual Adjust** is required.

B. Fine Tune Mode

Press \triangleleft or \triangleright to select “Auto fine Tune” and “Manual fine Tune”.

C. Sound System

Press \triangleleft or \triangleright to select Auto, B/G,I or D/K system.

D. Label

The video label allows you to label each input source for your TV.

To change or create video labels:

- Press ∇ or \triangle to select Label, and press yellow key to use the EDIT window as shown below.

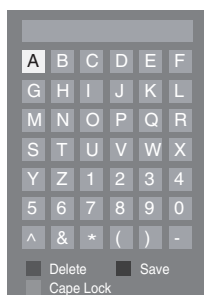

- Press ∇ , \triangle , \triangleleft and \triangleright to select character.
And you can use Delete and Caps Lock to edit your label name.
- Press Save to store your settings.

Channel List - digital only -

- From the **SET UP** menu, press ∇ or \triangle to select **Channel List**.

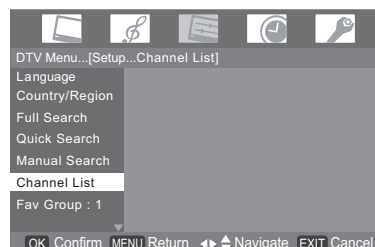

- Press \odot to display the **Channel List** menu.



- Press ∇ or \triangle to select the program position you want to arrange.

- Press \triangleright to display the breakdown menu.

- Press ∇ or \triangle to select an item, then press \odot to select the item as shown below.

- Add to Fav: 1** - Add selected channel to Favorite group 1.
- Add to Fav: 2** - Add selected channel to Favorite group 2.
- Add to Fav: 3** - Add selected channel to Favorite group 3.
- Sort: LCN** - Sort all channels by channel number.
- Sort: Name Down** - Sort all channels by name. (page 16)
- Sort: Name Up** - Sort all channels by name. (page 16)
- Delete** - Delete selected channel from the channel list.
- Lock/ Unlock** - Lock / Unlock selected channel by password.
- Move Up** - Selected channel will be move up one channel.
- Move Down** - Selected channel will be move down one channel.

Sorting program position

- The TV is capable of receiving a number of different channels depending upon where you live.
- Program sorting is an easy way of storing each channel on the program position of your choice.

Ex.: To swap channel A1. TEN Digital 1(Prog.13) for channel TEN Digital 2 (Prog.14):

- From the **SET UP** menu, Press **OK** and ∇ or \triangle to select **Channel List**.

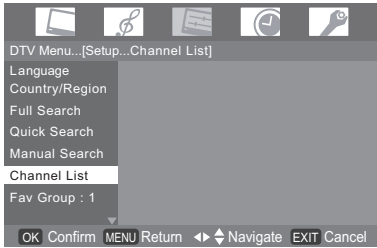

- Press **OK** to display the **Channel List** menu. Press ∇ or \triangle to select 13. TEN Digital 1

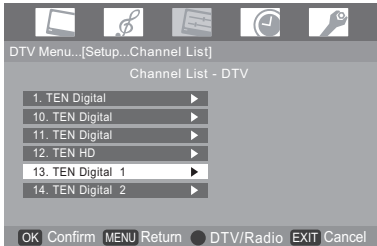

- Press ∇ or \triangle to select **Move Down** menu, then press **OK**.

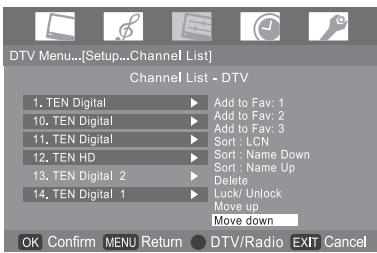

- Confirm new **Channel List** menu.

Favorite Channel

- Press **MENU**, then press \triangleleft or \triangleright to select the **SETUP** menu.
- Press **OK** and press ∇ or \triangle to select **Fav Group 1, 2 or 3**, then press **OK**.

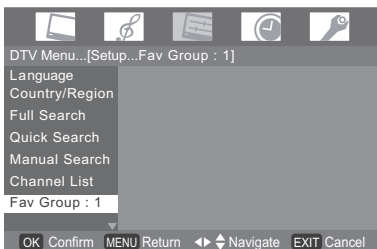

- Press \triangleright will display the breakdown menu.
- Press ∇ and \triangle to select an item.

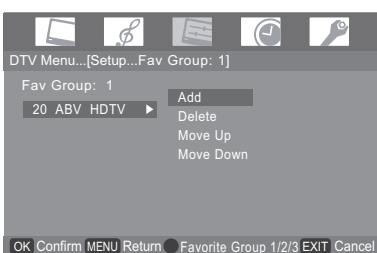

- Add** – Add selected channel from the channel list.
- Delete** – Delete selected channel from the channel list.
- Move Up** – Selected channel will move up one channel.
- Move Down** – Selected channel will move down one channel.

- You can press **OK** to save edited channel program and press **MENU** to exit .
- When viewing in Digital TV, press **LIST/FAV** to display the Fav Group channel list.
- Press ∇ and \triangle to select your favorite program, then press **OK**.

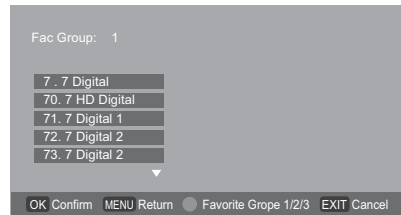

Channel List - analog only -

- From the **SET UP** menu, Press **OK** and ∇ or \triangle to select **Channel List** .

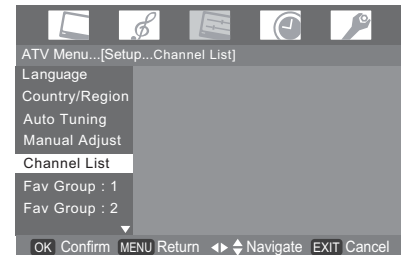

- Press **OK** to display the **Channel List** menu.

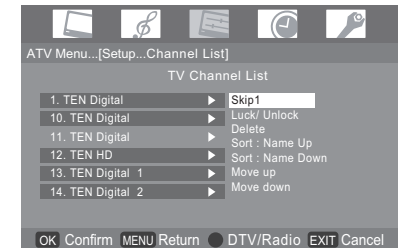

- Press ∇ or \triangle to select the program position you want to arrange.
- Press \triangleright to display the breakdown menu.
- Press ∇ or \triangle to select an item, then press **OK** to select the item as shown below.
 - Skip-** If you turn this option on, selected channel will be skipped when you select channels with **P^** or **P^v**.
 - Lock/ Unlock** – Lock / Unlock the channel by password.
 - Delete** – Delete selected channel from the channel list.
 - Sort: Name Up** - Sort all channels by name.
 - Sort: Name Down** - Sort all channels by name.
 - Move Up** – Selected channel will move up one channel.
 - Move Down** – Selected channel will move down one channel.

Watching TV programs

Viewing Digital programs - digital only -

After you have tuned the TV, you have several ways to navigate through all programs:

- Press the **Number** buttons (a channel number has 3-digits) and you may omit the leading zeroes, which will be appended automatically; (Please note that if you have channels with different frequencies but the same channel number, the TV will always tune to the first channel that has been stored into the channel database. To view the other duplicating channels, you can select the channels from the **Channel List-DTV** or use the **P[^]/P^v** buttons.)
- Press **P[^]/P^v** to view the previous and next program. The channels are arranged in ascending order according to the channel number.
- Press **LIST (FAV)** to display Favorite channel list and press **▽** or **△** to select a program, then press **OK** to view the favorite program.

Switching between two program positions

You can switch two program positions without entering actual position number each time.

- 1 Select the first program position you want to view.
- 2 Select the second program position with the Number buttons (0-9).
- 3 Press **⊕**. The previous channel will be displayed.

Each time you press **⊕**, the TV will switch back and forth between the two program positions.

Selecting the menu language

Choose from 3 different languages (English, French, Chinese(CS)) for the On-Screen-Display.

- 1 Press **MENU**, then press **◀** or **▶** to display **SET UP** menu.
- 2 Press **OK**, then press **▽** or **△** to select **Language**.
- 3 Press **OK**, then press **◀** or **▶** to select the desired language.

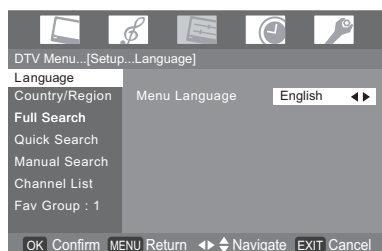

Displaying the on-screen information

- 1 Press **INFO** to display the following on-screen information.

- Analog TV -



The information will disappear in variable time which is dependent on banner duration setting.

- Program position or external input mode selected
- Label (if set)
- Mono/Stereo/Dual audio status
- Teletext signal status

- Video 1, Video 2, HDMI 1, HDMI 2, PC -



The information will disappear in variable time which is dependent on banner duration setting.

- Source input name
- Video input resolution

- Digital TV -



When viewing in Digital TV, the on-screen information will give the details of the channel program currently being viewed.

The contains the following information:

- Current Channel Number and Name
- Received program video format
- Current time
- Subtitle (closed-caption) availability (indicated by CC)
- Teletext availability (indicated by TTX)
- Dolby® Digital audio track availability (indicated by **Dolby D**)
- Now and Next Program Names
- Parental Guidance code (PG, MA, G, R, etc.)
- Audio setting
- Signal Strength

- 2 To close the display instantly, press **EXIT**.

Setting the On-Screen-Display Time

- 1 From the **TIMER** menu, press **▽** or **△** to select **Banner Duration**.
- 2 Press **OK**, then press **◀** or **▶** to set duration time for which on-screen information will stay on the screen.

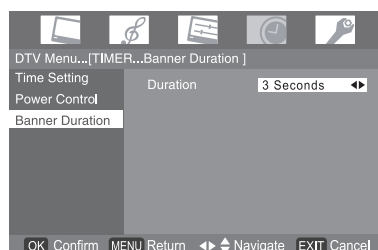

Using the TV's features (General)

Picture adjustment

Selecting the picture size

- 1 Each time you press , picture size information will change again. The information will disappear in variable time, which is dependent on banner duration setting.



- 2 Picture size will change as below mode:
Wide, Super Live 2, Cinema 2, 4:3, Super Live 1, Cinema 1, Subtitle and 14:9.

Auto - HDMI only -

Use this setting when watching a wide-screen DVD, widescreen video tape or a 16:9 broadcast (when available), then aspect ratio will automatically follow DVD player of HDMI output format to change the same picture size to display. You can easily see good display on the screen.

Wide

Use this setting when watching a wide-screen DVD, widescreen video tape or a 16:9 broadcast (when available). Due to the range of wide-screen formats (16:9, 14:9, 20:9 etc.), you may see bars on the top and bottom of the screen.

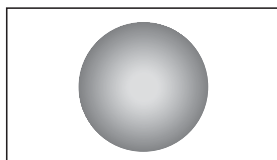

Super Live 2

When receiving "side panel format" signal, this setting will enlarge the image to fit the screen by stretching the image vertically and horizontally, holding the better proportions at the center of the image. Also the black bars on the both sides of the screen will eliminate or reduce.

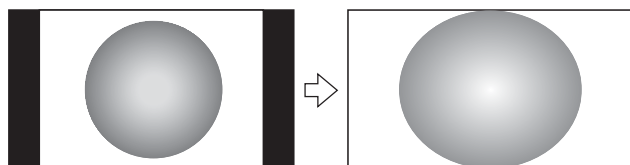

Cinema 2

When watching "all sides panel format" films/video tapes, this setting will eliminate or reduce the black bars on all the sides of the screen by zooming in and selecting the image without distortion.

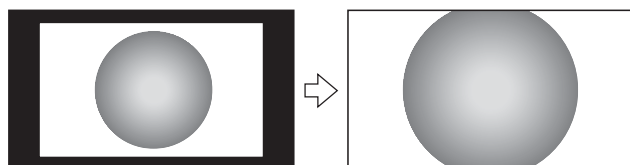

4:3

Use this setting to view a true 4:3 broadcast may see bars on the top and bottom of the screen.

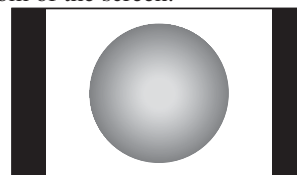

Super Live 1

When receiving "4:3 format" signal, this setting will enlarge the image to fit the screen by stretching the image vertically and horizontally, holding the better proportions at the center of the image.

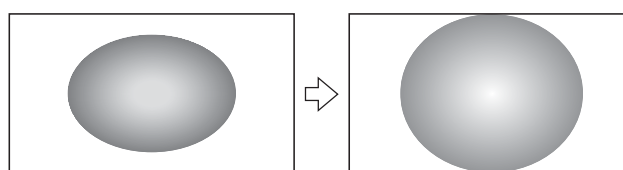

Cinema 1

When watching "letterbox format" films/video tapes, this setting will eliminate or reduce the black bars at the top and bottom of the screen by zooming in and selecting the image without distortion.

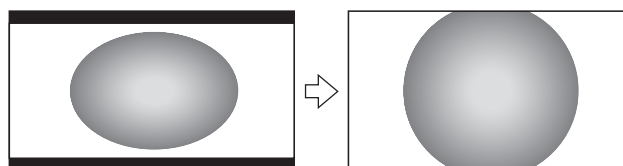

Subtitle

When subtitles are included on a letterbox format broadcast, this setting will raise the picture so that the most of text is displayed.

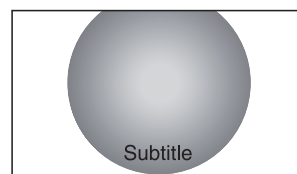

14:9

Use this setting when watching a 14:9 broadcast.

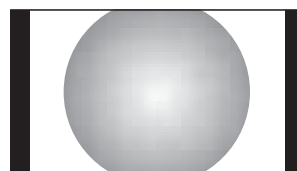

PC

Use this setting for PC via HDMI. When receiving 1080i or 720p signal format of HDMI input, this picture size is available.

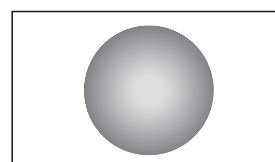

Notes:

- Using the special functions to change the size of the displayed image (e.g. changing the height/width ratio) for the purpose of public display or commercial gain may infringe on copyright laws.
- If the aspect ratio of the selected format is different from the one of the TV transmission or video program, it can cause a difference in vision. Change to the correct aspect ratio picture size.
- In the PC input mode (see page 23), the picture size selection is wide or 4:3 only.
- When DTV teletext (see page 25) displayed, the picture size selection is not available.
- When Subtitle (see page 27) displayed, the picture size selection is available.
- In Digital TV, the picture size selections are **Super Live 1, Cinema 1, Wide, Super Live 2, Cinema 2** and **4:3**.
- When using the **PC** mode, the moving image quality may be deteriorated.

Using the picture still

- Press to freeze the picture. Even if an image is frozen on the TV screen, the pictures are running on the input source. Audio continues to be output as well.
- To return to a moving picture, press again.

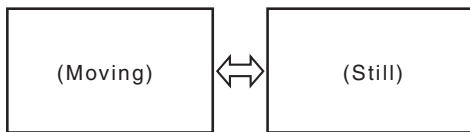

Notes:

- If you use this function except for the purpose of your private viewing and listening, it may infringe the copyright protected by the copyright laws.

Adjusting the picture position - PC only -

Adjustment to the position of the picture may be made to suit your viewing preferences.

- 1 Press , then press or to display the **PICTURE** menu, then press .
- 2 Press the or to select **VGA Set**, then press .

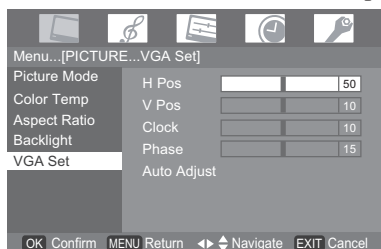

- 3 Press the or to select **H pos, V pos, Clock** and **Phase**.
- 4 Press or to adjust to settings as required.

Automatically Adjusting the picture position

- PC only -

Adjustment to the position of the picture may be made to suit your viewing preferences.

- 1 From the **VGA Set** menu, press or to select **Auto Adjust**.
- 2 Press , then TV starts adjusting the picture position.

Selecting the picture mode

You can select the picture quality instantly among three preset modes and one user-set mode.

- Press to select the desired picture quality.



Mode	Picture quality
Dynamic	Bright and dynamic picture
Standard	Standard picture
Movie	Mild soft picture
Memory	Memory the picture quality you set

Note:

In the PC input mode (see page 23), this mode is not available.

Adjusting the basic picture quality

- 1 Press , then press or to display the **PICTURE** menu.
- 2 Press , then press or to select **Picture Mode**.
- 3 Press or to select **Memory**.

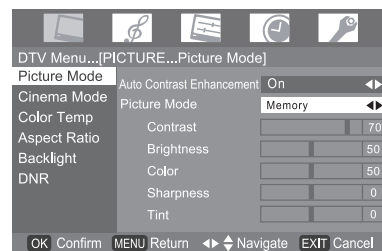

- 4 Press or to select an item you want to adjust, then press or to adjust the setting as required.



Selection		Pressing	
Contrast	lower		higher
Brightness	darker		lighter
Color	paler		deeper
Sharpness	softer		sharper
Tint	reddish		greenish

Notes:

- The **Tint** may only be adjusted on a tape which has been recorded and played back on an NTSC VCR.
- In the PC input mode (see page 23) **Sharpness** mode is not available.

Activating the DNR (Digital Noise Reduction)

If the receiving signal is weak and the picture is blurry, the picture may be improved when using this function.

- 1 From the **Picture** menu, press ∇ or \triangle to select **DNR** then press OK .
- 2 Press ∇ or \triangle to select an item you want to adjust, press \triangleleft or \triangleright to adjust the settings as required.

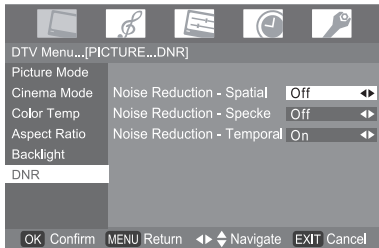

Note:

In the PC input mode, this mode is not available.

Selecting the color temperature

You can change the tone of the picture by selecting from three preset color temperatures: **Cool**, **Normal** or **Warm**.

- 1 From the **Picture** menu, press ∇ or \triangle to select **Color Temp** then press OK .
- 2 Press \triangleleft or \triangleright to select mode you prefer.

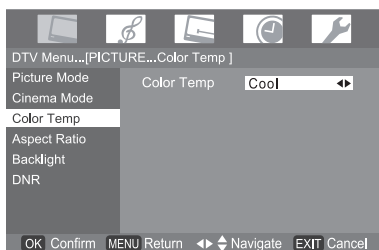

Cool: Lends a blue hue to the picture.

Normal: Neutral

Warm: Lends a red hue to the picture.

Using the active backlight control

In order to improve screen visibility, the active backlight control sets the screen brightness automatically during dark scenes.

- 1 From the **Picture** menu, press ∇ or \triangle to select **Backlight** then press OK .
- 2 Press \triangleleft or \triangleright to select **Off** or **On**.

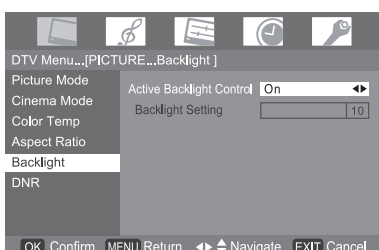

- 3 If you want to adjust **Backlight** manually, turn **Active Backlight Control** to **Off**, then press ∇ .

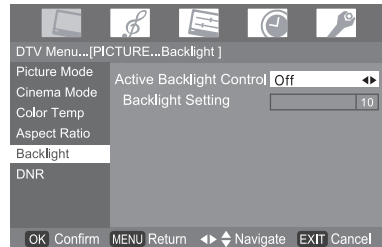

- 4 Press \triangleleft or \triangleright to adjust the settings as required.



Using the cinema mode

A movie film's picture runs at 24 frames a second, whereas movie software such as DVD, etc., that you enjoy watching on television at home runs at 30 (NTSC) or 25 (PAL) frames a second. To convert this signal to reproduce a smooth motion and picture quality, select the **On** mode.

Effective signal and setup conditions:

- When the Video input mode is selected.
- When the input signal format is 480i and 576i signals.

- 1 Press MENU , then press \triangleleft or \triangleright to display the **PICTURE** menu then press OK .
- 2 Press ∇ or \triangle to select **Cinema Mode** then press OK .
- 3 Press \triangleleft or \triangleright to turn **On** or **Off**.

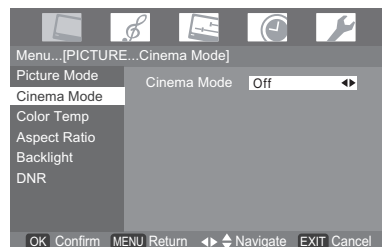

Note:

When a DVD movie with subtitle is playing back, this mode may not work correctly.

Cinema Mode only support to Video 1, Video 2, HDMI 1 and HDMI 2 input sources.

Sound adjustment

Setting the MTS (Multi-channel TV Sound)

- analog only -

Auto mode

The MTS Auto mode automatically recognize stereo/bilingual programs depending on the broadcast signal.

- 1 Press **MENU**, then press **◀** or **▶** to display the **SOUND** menu then press **OK**.
- 2 Press **▽** or **△** to select **MTS**, then press **OK** and **◀** or **▶** to select **Auto** or **Mono**.



Mono mode

If you experience noise or poor reception of any stereo/bilingual program, set the **Sound** mode to **Mono**. Noise will be reduced and reception may improve.

Note:

If you experience noise with a particular program on whose channel reception is usually good, try setting MTS mode to Auto, then switch **COI/VI** to **○ Mono (monaural)** (see page 22).

Selecting the dual 1 or dual 2 mode

- analog only -

You can hear only dual 1 or dual 2 sound selected, whenever bilingual programs are received.

- 1 Press **MENU**, then press **◀** or **▶** to display the **SOUND** menu then press **OK**.
- 2 Press **▽** or **△** to select **Dual**, then press **OK** and **◀** or **▶** to select **Dual 1** or **Dual 2**.

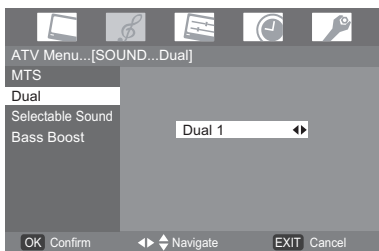

Notes:

- When the MTS setting is in **Mono** mode, the **Dual** menu is not selectable.
- The **Dual** menu setting status remains even if the TV is turned off.

Selecting the stereo programs - analog only -

- 1 When a stereo program is received, **Stereo** appears.
- 2 Press **COI/VI** to select the Auto/Mono mode. **Auto** and **Mono** appear cyclically on the screen.



Selecting the bilingual programs - analog only -

- 1 When a bilingual program is received, **Dual** appears.
- 2 Press **COI/VI** to select the sound to be heard. The sound differs according to the transmission system: NICAM or German stereo/bilingual broadcast.

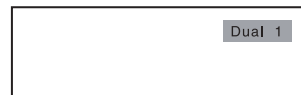

Display	Sound to be heard	
	NICAM	German stereo/ bilingual broadcast
Dual 1	Sub I sound	Main sound
Dual 2	Sub II sound	Sub sound
Mono	Main sound	---

Note:

These settings are not stored in the TV memory.

Adjusting the sound quality

- 1 Press **MENU**, then press **◀** or **▶** to display the **SOUND** menu then press **OK**.
- 2 Press **▽** or **△** to select **Selectable Sound**, then press **OK** and **◀** or **▶** to select **Standard**, **Movie**, **Music** and **User**.

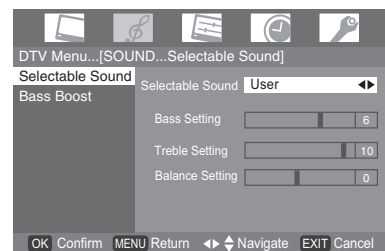

- 3 In **User** item, you can press **▽** or **△** to select an item you want to adjust, press **◀** or **▶** to adjust the settings as required.
When you select **Standard**, **Movie** or **Music**, the setting was fixed and can't adjust.

Selection	◀ Pressing	▶
Bass	weaker	stronger
Treble	weaker	stronger
Balance	decreases the right channel	decreases the left channel

Using the Bass Boost

- 1 From the **SOUND** menu, press ∇ or Δ to select **Bass Boost** then press OK .
- 2 Press \triangleleft or \triangleright to select **Off, Low, Mid and High**.

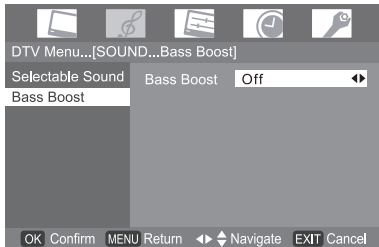

Note:

The Bass Boost effect is active only when the sound outputs from the speaker.

The timers

Setting the Current Time

The **Current Time** is especially useful if you want to setting up current time for TV.

- 1 Press MENU , then \triangleleft or \triangleright to display the **TIMER** menu, then press OK .
- 2 Press ∇ or Δ to select **Time Setting**, then press OK .
- 3 Press ∇ or Δ to select **Current Time**, then press OK .

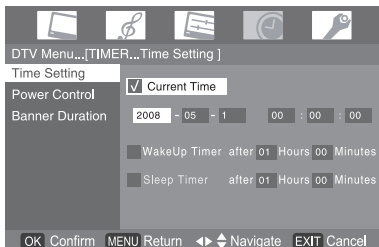

- 4 Press \triangleright into the Timer data position and press ∇ or Δ to set up current time.
- 5 Press OK to save the **Time Setting**.

Notes:

If TV receives time information in digital TV signal, TV will automatically update current time.

Setting the Wakeup Timer

The Wakeup timer is especially useful if you want the TV to turn itself on after a selected period of time.

- 1 Press MENU , then \triangleleft or \triangleright to display the **TIMER** menu, then press OK .
- 2 Press ∇ or Δ to select **Time Setting**, then press OK .
- 3 Press ∇ or Δ to select **Wakeup Timer**, then press OK .

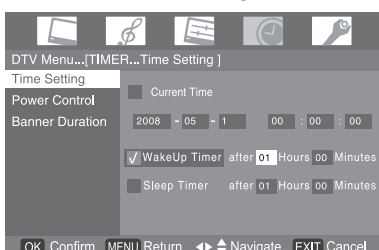

- 4 Press \triangleright into the Timer data position and press ∇ and Δ to set the time period.
- 5 Press EXIT to exit Menu.
- 6 Press Power on the remote control or control panel.

Setting the Sleep Timer

The **Sleep Timer** is especially useful if you want the TV to turn itself off after a selected period of time.

- 1 Press MENU , then \triangleleft or \triangleright to display the **TIMER** menu, then press OK .
- 2 Press ∇ or Δ to select **Time Setting**, then press OK .
- 3 Press ∇ or Δ to select **Sleep Timer**, then press OK .

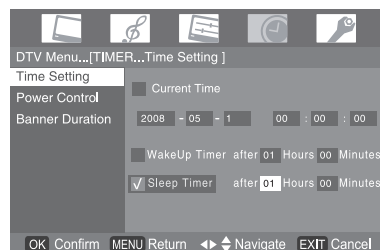

- 4 Press \triangleright into the **Timer** data position and press ∇ and Δ to set the time period.
- 5 Press EXIT to start the timer.

Notes:

After power code unplug/plug, the **Timer** setting change to default.

Setting the Power Control

- 1 Press MENU , then \triangleleft or \triangleright to display the **Timer** menu, then press OK .
- 2 Press ∇ or Δ to select **Power Control**, then press OK .
- 3 Press ∇ or Δ to select which you want adjust, then press \triangleleft or \triangleright to set function.

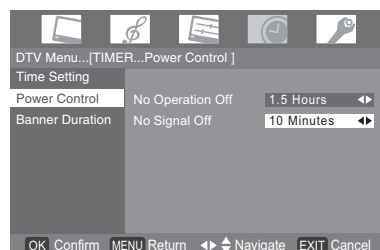

- A. **No Operation Off** can be set Disable or 1 to 6 hours.
- B. **No Signal Off** can be set Disable or 5 to 45 minutes.

Notes:

- If you set **No Operation Off** for 1~6 hours, it will automatically power off when you do not do any operation.
- If you set **No Signal Off** for 5~45 minutes, it will automatically power off when input has no signal.
- **Power Control** function (**No Signal Off**) will work only on the video 1, video2, PC, HDMI and DTV sources.

Setting the Banner Duration - digital / analog -

- 1 Press **MENU**, then **◀** or **▶** to display the **TIMER** menu, then press **OK**.
- 2 Press **▽** or **△** to select **Banner Duration**, then press **OK**.
- 3 Press **◀** or **▶** to set **Banner Duration** which can be set 1 to 12 seconds.

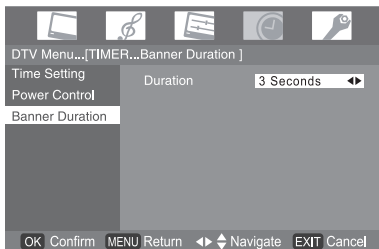

Notes:

- **Banner Duration** function is setting for DTV information and on-screen information display timing.
- On-Screen-Display will remain about 1 minute.

Selecting the video input source to view

- 1 Press **↻** on the remote control to display the video input mode list, then press **▽** or **△** to select appropriate input source. You may also press **i+** to display the video input mode.

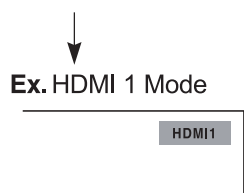
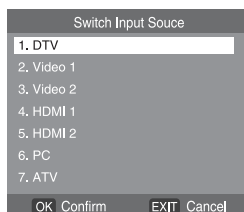

- 2 Press **OK**.
 - DTV** (Digital TV)
 - Video 1** (CVBS input or component video input) (see page 27)
 - Video 2** (CVBS input or S-video input) (see page 27)
 - HDMI 1, HDMI 2** (**↻** HDMI1 or **↻** HDMI2, HDMI input)
 - PC** (**↻** RGB/PC, PC input)
 - ATV** (Analog TV)

Teletext in Analog TV

This TV has a multi-page teletext memory, which takes a few moments to load and it offers two ways of viewing Teletext Auto and LIST which are explained below.

Setting up the teletext mode

To select teletext mode:

Select a channel position with the desired teletext service.

- 1 Press **MENU**, then press **◀** or **▶** to display the **FUNCTION** menu.

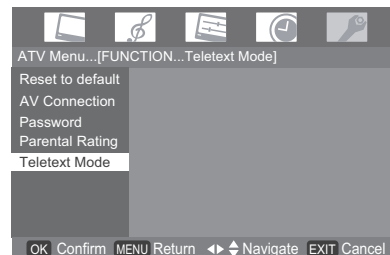

- 2 Press **▽** or **△** to select **Teletext Mode**, then press **◀** or **▶** to select **Auto** or **LIST** mode.

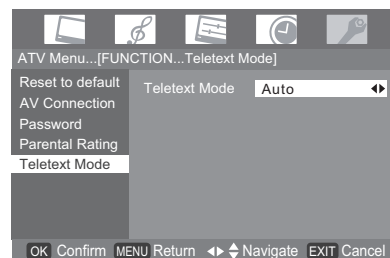

Note:

When you are watching the teletext program, **SET UP** menu and **FUNCTION** menu are not selectable.

Teletext general information

⏏/⏏/⏏ button:

Pressing **⏏/⏏/⏏** once will bring up the teletext screen. Press again to superimpose the teletext over a normal broadcast picture. Press again to return to normal TV mode. You need to return to normal viewing if you wish to change channels.

When you first press **⏏/⏏/⏏** to access the text service, the first page you see will be the initial page.

In **Auto** mode, this displays the main subjects available and their relevant page numbers.

In **LIST** mode, you will see the page numbers currently stored on the **each color** button

Sub-pages:

Once in this chosen page, if there are sub-pages they will automatically load into memory without changing the one you are reading. If there are many sub-pages, it will take a long time for them all to load and this will depend on the speed with which the broadcaster transmits them.

To access the sub-pages in memory, press **⏏, then use **◀** or **▶** to view them.**

Note:

If you press **⏏** while the picture mode is activated, this mode will be cancelled.

Using Auto mode

There are two Modes: **Auto** will display FASTEXT or TOPTTEXT, if available. **LIST** will display your four favorite pages. In either mode, as an alternative to the colored buttons, you can access a page by entering a 3-digit number, using the **Number** buttons on the remote control, or to advance to the next page, press **P**^ or Δ , to go back to the previous page press **P**^ or ∇ .

To change between **Auto** and **LIST**, see above.

- Press $\text{TV}/\text{TV}/\square$ to access teletext.

Ex. FASTEXT

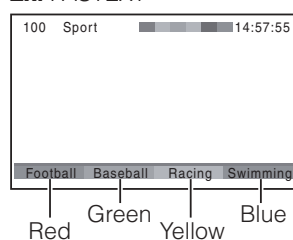

If FASTEXT or TOPTTEXT is available, you will see 4 colored titles at the bottom or top of the TV screen respectively. To access any given subject, simply press the relevant colored button on the remote control.

If FASTEXT or TOPTTEXT is not available, you can access any page simply by entering a 3-digit page number or pressing the corresponding colored button.

For further information on your particular text system(s), see the broadcast teletext index page or consult your local Toshiba dealer.

Using LIST mode

- 1 Press $\text{TV}/\text{TV}/\square$ to access teletext.

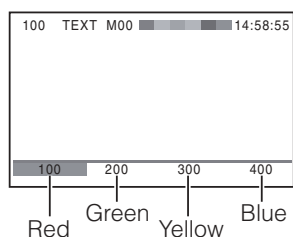

The four choices at the bottom of the screen are now number – **100**, **200**, **300** and **400**, which have been programmed into the TV's memory.

- 2 To view these pages, use the colored prompt buttons. e.g. press the Green button to view page 200.
- 3 If you want to change these stored pages, press the colored button for the color you want to change. e.g. Press the Green button and enter the 3-digit number.

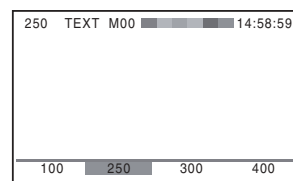

This number will change in the top left of the screen and in the colored highlight.

- 4 Press OK to store your choice. The bars at the bottom of the screen will flash white.
- 5 You may view other pages by simply entering the 3-digit page number – but NEVER press OK or you will lose the favorite already stored.

Teletext buttons on the remote control

Below is an introduction to the teletext buttons on your remote control and their functions.

TV To display an index/initial page: In Auto mode

Press TV to access the index page. The one displayed is dependant on the broadcaster.

In LIST mode

Press TV to return to the 100 page or initial page.

TV To reveal concealed text:

Some pages cover topics such as quizzes and jokes. To discover the solutions, press TV .

TV To hold a wanted page:

This function is included as it is part of the broadcast teletext system but you will not need it as this TV allows you to control the display of sub-pages.

TV To enlarge the teletext display size:

Press TV once to enlarge the top half of the page, press again to enlarge the bottom half of the page. Press again to revert to the normal size.

TV/TV To select a page while viewing a normal picture:

When in teletext mode, if a page selection is made and then TV/TV is pressed, a normal picture will be displayed. The TV will indicate when the page is present by displaying the title bar of the text page at the top of the screen. Press $\text{TV}/\text{TV}/\square$ to view the page.

Note:

It will not be possible to change program position while in Teletext mode, you will have to cancel the teletext first by pressing $\text{TV}/\text{TV}/\square$ to return to a normal TV picture..

Teletext in Digital TV

- 1 When **i+** indicates the presence of Teletext (TTX) in a channel, press **TEXT** to view Teletext. Press **TEXT** again to superimpose the Teletext over a normal broadcast picture. Press again to close Teletext and watch TV.
- 2 Press **P[^]** and **P^v** to select Teletext page. Press the **Number** buttons to input a Teletext page to view the page directly. If FASTEXT is available, simply press the relevant colored button on the remote control.
- 3 Press **EXIT** to close the Teletext and watch TV.

Reset all default setting

When any user require to reset adjustment values of the Picture, Sound, Setup, Timer and Function that can use **Reset to default** to back factory default setting.

- 1 From the **FUNCTION** menu, press **▽** or **△** to select **Reset to default** and press **OK**.

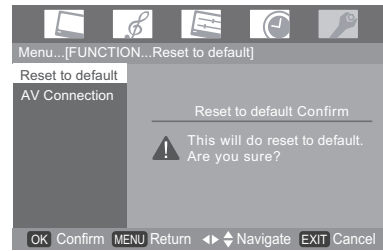

- 2 Press **OK**, a confirmation screen will appear indicating that **This will do Reset to default, Are you sure?**
- 3 Press **OK** to start the **Reset to default**.

Note:

TV channel list and password won't be reset.

Other Digital TV features and settings

Setting the EPG (Electronic Program guide) - digital only -

- 1 Press **MENU**, then **◀** or **▶** to select **Function** menu.
- 2 Press **OK** and **▽** or **△** to select **EPG** then, press **OK** to display **EPG**.

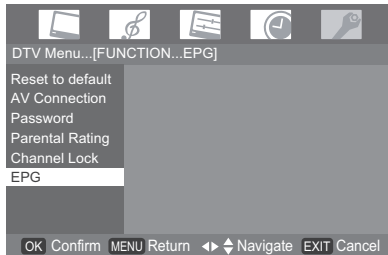

- 3 Press **△**, **▽**, **◀**, **▶** to select the channel, names of the program being broadcast will appear.

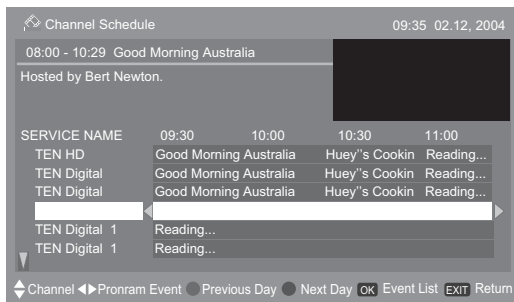

- 4 Press **OK**, then **Event List** will appear.

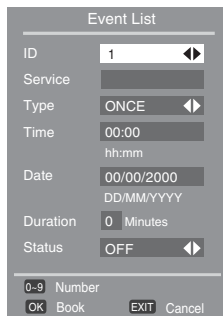

- 5 Press **△** or **▽** to select an item, then press **◀** or **▶** to change the content, then press **OK** to save.

Note:

Toshiba does not provide **EPG** data; therefore Toshiba is not liable for the content of such data. The data provider may elect to discontinue the service or it may cease to be (or never be) available in your area. In any of these circumstances, the **EPG** feature will not function. Toshiba is not liable in the event that this service is unavailable or for any consequences arising from customers having used or not being able to use this service.

Password

In Digital TV, channels and programs can be locked to prevent viewing of unsuitable films and programs. These can only be accessed with a password. Default password is 0000.

Setting the Password

- 1 Press **MENU**, then press **◀** or **▶** to select the **FUNCTION** menu.
- 2 Press **OK** and press **▽** or **△** to select **Password**, then press **OK**.

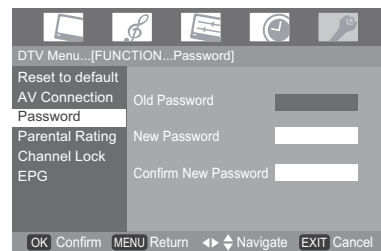

- 3 Enter your password using the number buttons or press 0000 (which is the default password), then press **▽**.
- 4 Press **▽** and enter your new password, then press **▽** to confirm again, then press **OK**.

Note:

Note: If you forgot the password, press [Green], [Yellow], **OK** and **EXIT** buttons on the remote control so that the password returns to the default setting (0000).

Parental Rating

The type of program displayed on the TV can be limited based on the parental guidance codes. See Appendix for Australian parental guide code.

Setting the Parental Rating

- 1 Press **MENU**, then press **◀** or **▶** to select the **FUNCTION** menu.
- 2 Press **OK** and **▽** or **△** to select **Parental Rating**, then press **OK**.

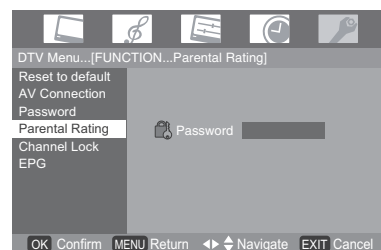

- 3 Enter password when prompted.
- 4 Press **◀** or **▶** to select the suitable Rating, then press **OK** to save.

AV Connection

- 1 Press **MENU**, then press **◀** or **▶** to select the **FUNCTION** menu.
- 2 Press **OK** and press **▽** or **△** to select **AV Connection**, then press **OK**.

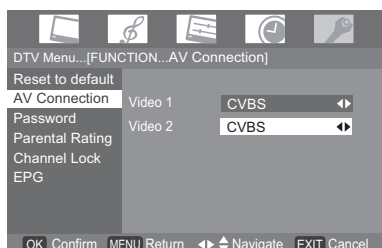

- 3 Press **▽** or **△** to select **Video 1** or **Video 2**, then press **◀** or **▶** to select input source as required.
Video 1 selections are **YPbPr** and **CVBS**.
Video 2 selections are **CVBS** and **S-Video**.

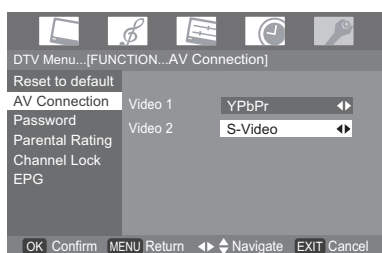

Subtitle

- 1 When on-screen information indicates the presence of Subtitle (CC) in a channel, press **SUBTITLE** to display the current **Subtitle** status. While this status is displayed, press again to change the setting. Subtitle On or Off can be selected.
- 2 If you switch off the TV, the **Subtitle** mode will be remembered the next time it is switch ON.

Notes:

- If **Subtitle** is ON, the TV will always display subtitle whenever such information is available in the channel you are viewing. You may use **i+** to check if subtitle is currently available.
- In Australia, you may also view **Subtitle** by directly entering page 801 in Teletext. However, by doing so, the TV remains in Teletext mode and you cannot change the channels because **P^** and **Pv** will change Teletext pages rather than channels. To view subtitle, it is recommended that you turn on Subtitle mode.
- If **Subtitle** is ON, When user press ***** on remote control that audio mute function can work but the TV won't display mute icon in screen.

Audio Preference

Selecting The Audio Mode

- 1 From the **SETUP** menu, press **▽** or **△** to select **Audio Mode**, then press **OK**.
- 2 Press **▽** or **△** to select **Audio Mode** or **Digital Audio Output** then press **◀** or **▶** to select mode.

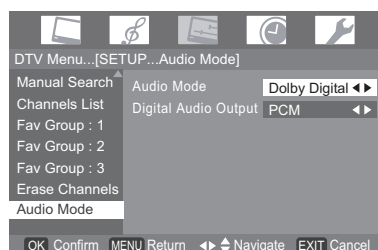

- 3 Press **◀** or **▶** to select **Dolby Digital** or **MPEG**.

Dolby Digital

If you select this option, the TV will select the first Dolby Digital audio track, if available. However, if the channel does not contain any Dolby Digital audio track, then the first available MPEG audio track will be selected.

MPEG

If you select this option, the TV will select the first MPEG audio track, if available. However, if the channel does not contain any MPEG audio track, then the first available Dolby Digital audio track will be selected.

Note:

Manufactured under license from Dolby Laboratories. "Dolby" and the double-D symbol are trademarks of Dolby Laboratories.

Digital Output Format

- 1 From the **Audio Mode**, press **◀** or **▶** to select **Digital Audio Output**.
- 2 Press **◀** or **▶** to select **Bitstream** or **PCM**.

Bitstream: Select this when an amplifier equipped with builtin Dolby Digital or MPEG decoder is connected to this TV.

PCM: Select this when a 2ch digital stereo amplifier is connected to this TV. When you select a Dolby Digital or MPEG audio track in Audio Track, the sound is converted to the PCM (2ch) format and output.

Connecting your TV

Back connections

Connection example

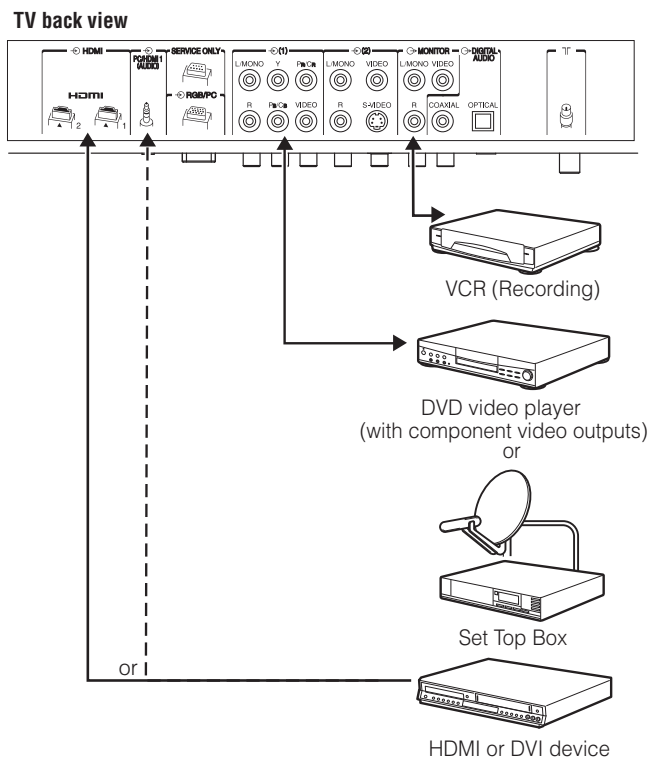

- Before connecting any external equipment, turn off all main power switches.
- The unauthorized recording of television programs, DVDs, video tapes and other materials may infringe upon the provisions of copyright law.
- The **COMPONENT VIDEO INPUT** consists of three component video signals (**Y**, **P_B/C_B**, **P_R/C_R**) and provides the best picture performance. These terminals can only be used with the component video compatible equipment e.g. DVD video player, etc.
- Additional equipment and cables shown are not supplied with this TV.
- **MONITOR OUTPUT**
That will only support ATV/DTV signal to display out or by VCR TV signal recording use.
- If you connect mono sound equipment to **MONITOR OUTPUT**, connect the audio input of the equipment to the **L/MONO** jack on the TV.

Connecting an audio system - digital only -

You can enjoy high quality dynamic sound by connecting the TV to an audio system.

Notes:

- **DO NOT** connect the **DIGITAL AUDIO** output terminal to the AC-3 RF input of a Dolby Digital Receiver with a built-in Dolby Digital decoder.
- Connect the **DIGITAL AUDIO** output terminal to the **Optical** or **Coaxial** input of a Receiver or Processor.
- Refer to the owner's manual of the connected equipment as well.
- When you connect the TV to other equipment, be sure to turn off the power and unplug all of the equipment from the wall outlet before making any connections.
- The output sound of the TV has a wide dynamic range. Be sure to adjust the audio amplifier's volume to a moderate listening level before turning on the power. Otherwise, the speakers and your hearing may be damaged by a sudden high volume sound.
- Turn off the amplifier before you connect or disconnect the TV's power cord. If you leave the amplifier power on, the speakers may be damaged.

Warning:

When you are connecting (via the **DIGITAL AUDIO** output terminal) an AV decoder that does not have Dolby Digital or MPEG decoding function, be sure to set **PCM** in Digital Output (page 32). Otherwise, the speakers and your hearing may be damaged by a sudden high volume sound.

Connecting an amplifier equipped with a Dolby Digital decoder

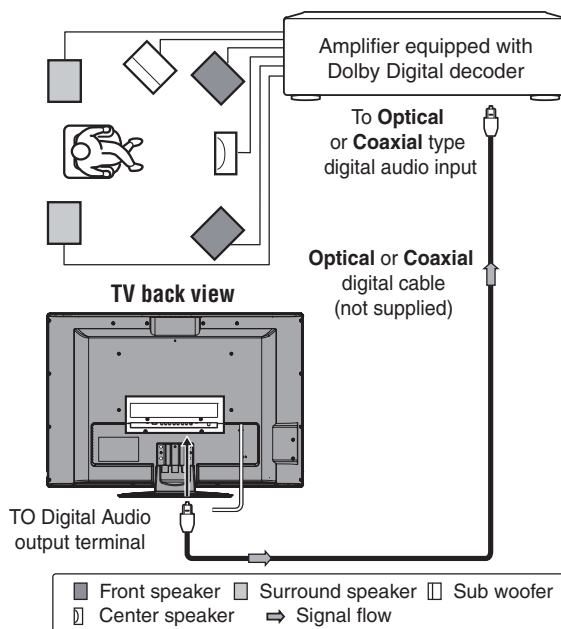

You can enjoy dynamic realistic sound by connecting the TV to an amplifier equipped with a Dolby Digital decoder or Dolby Digital processor. When using this setup, select **Bitstream** in Digital Output menu.

Connecting an amplifier equipped with an MPEG decoder

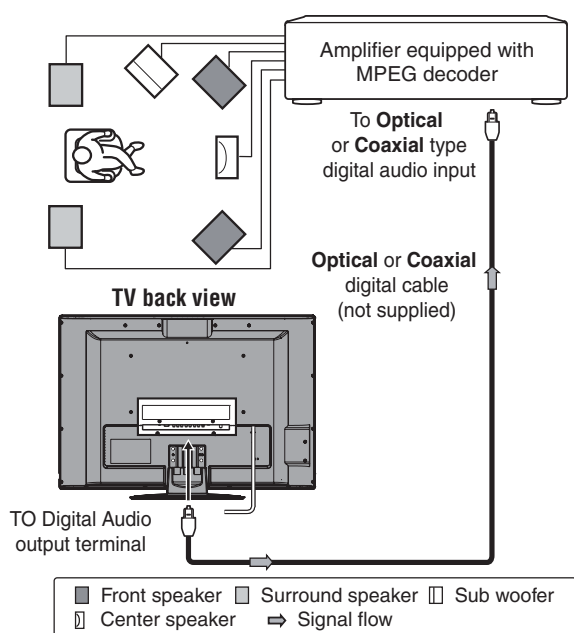

You can enjoy motion picture with dynamic realistic sound by connecting the TV to an amplifier equipped with an MPEG audio decoder or MPEG audio processor. When using this setup, select **Bitstream** in Digital Output menu.

Connecting an amplifier equipped with a digital audio (optical or coaxial) input

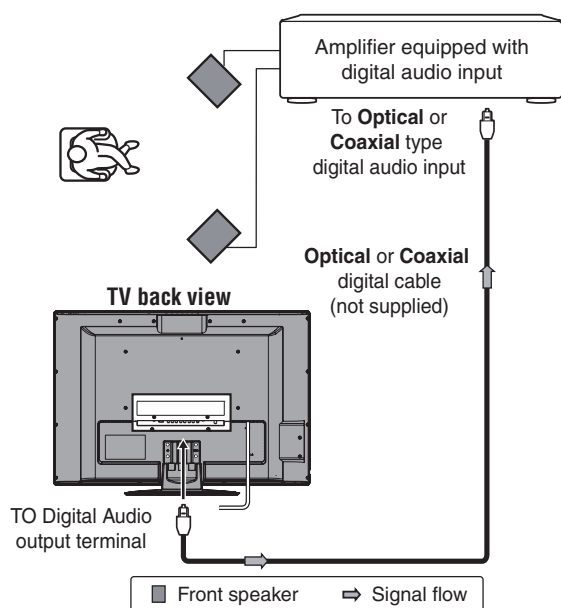

You can enjoy dynamic sound of 2-channel digital stereo by connecting the TV to an amplifier equipped with a digital audio (optical or coaxial) input and speaker system (right and left front speakers). When using this setup, select **PCM** in Digital Output menu.

Side connections

Connection example

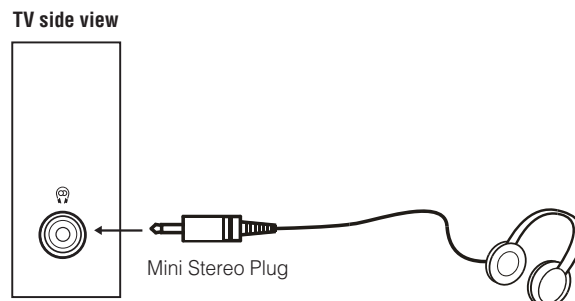

- The audio from the speaker will be muted when connecting the headphone to this terminal.

Connecting an HDMI or a DVI device

- This TV is not intended for connection to and should not be used with a PC.
- When turning on your electronic components, turn on the TV first, and then the HDMI or DVI device.
- When turning off your electronic components, turn off the HDMI or DVI device first, and then the TV.
- This TV may not be compatible with features and/or specifications that may be added in the future.
- This TV is only operable with L-PCM on 32/44, 1/48 kHz and 16/20/24 bits.

Connecting an HDMI or a DVI device

The HDMI input on your TV receives digital audio and uncompressed digital video from an HDMI device or uncompressed digital video from a DVI device. This input is designed to accept HDCP program material in digital from EIA/CEA-861/861B compliant consumer electronic devices (such as a set top box or DVD player with HDMI or DVI output). The HDMI input is designed for best performance with 1080i (50 Hz/60 Hz), 1080p (50Hz/60Hz) high-definition video signals, but will also accept and display 480i, 480p, 576i, 576p, 720p (50 Hz/60 Hz (60Hz: except for the E-EDID)) and VGA signals.

- **HDMI:** High-Definition Multimedia Interface
- **DVI:** Digital Video Interface
- **HDCP:** High-bandwidth Digital Content Protection
- EIA/CEA-861/861B compliance covers the transmission of uncompressed digital video with high-bandwidth digital content protection, which is being standardized for reception of high-definition video signals. Because this is an evolving technology, it is possible that some devices may not operate properly with the TV.
- **E-EDID:** Enhanced-Extended Display Identification
- **VGA:** VESA 640 x 480 @ 60 Hz
- **L-PCM:** Linear-Pulse Code Modulation

Connecting an HDMI device

One HDMI cable (type A connector)

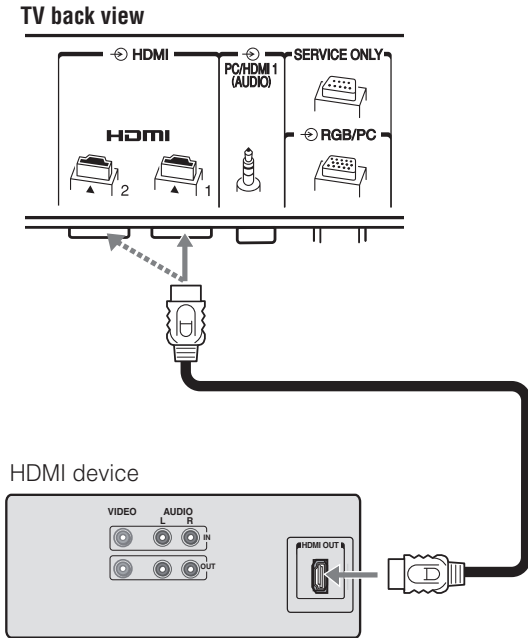

For proper operation, it is recommended that you use a short HDMI cable.

HDMI cable transfers both video and audio.

Note:

It is possible that some HDMI device may not operate properly with this TV.

Connecting a DVI device

One HDMI (type A connector)-to-DVI adapter cable and audio cables

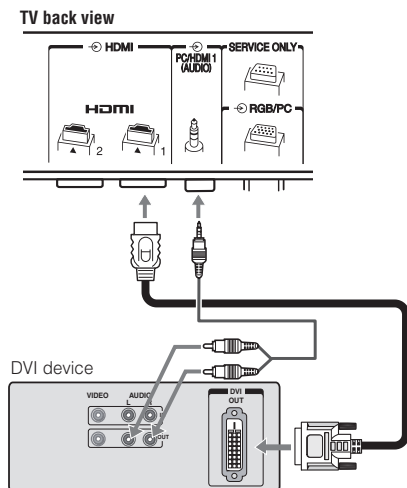

HDMI (type A connector)-to-DVI adapter cable

For proper operation, the length of an HDMI-to-DVI adapter cable should not exceed 3m. The recommended length is 2m.

Standard analog audio cables

An HDMI-to-DVI adapter cable transfers only video. Separate analog audio cables are required.

Note:

HDMI, the HDMI logo, and High-Definition Multimedia Interface are trademarks or registered trademarks of HDMI Licensing, LLC.

Connecting a computer

An analog RGB (15 pin) computer cable can be connected.

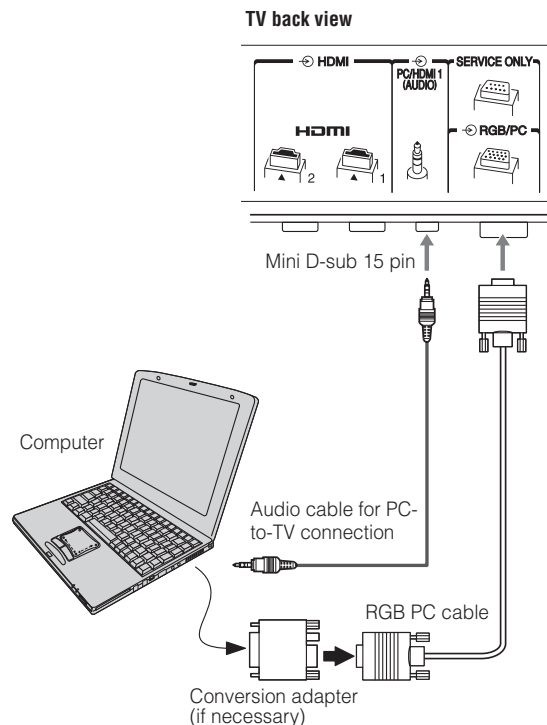

Connect a PC cable from the computer to the  RGB/PC terminal on the back of the TV.

The following signals can be displayed:

- VGA: VESA 640 x 480 @ 60/72/75 Hz
- SVGA: VESA 800 x 600 @ 60/72/75 Hz
- XGA: VESA 1024 x 768 @ 60/70/75 Hz
- W-XGA: VESA 1280 x 768 @ 60/75 Hz
- W-XGA: VESA 1360 x 768 @ 60 Hz
- S-XGA: VESA 1280 x 1024 @ 60/75 Hz (Compressed)

However, these signal formats are converted to match the number of pixels of the LCD panel.

Therefore, the TV may not display small text properly.

If you connect this unit to your PC, the compressed image is displayed in S-XGA mode, therefore the picture quality may deteriorate and characters may not be read.

Notes:

- *Some PC models cannot be connected to this TV.*

- There is no need to use an adapter for computers with DOS/V compatible mini D-sub 15 pin terminal.
- A bar may appear in the upper, lower, right or left side of the screen, or parts of the picture may be obscured depending on some signals. This is not the malfunction.
- If the edges of the picture are stretched, readjust the picture position adjustments in the **VGA SET** of **PICTURE** menu.
- Depending on the specification of the PC you are playing the DVD-Video on, and the DVD's title, some scenes may be skipped, or you may not be able to pause during multi-angle scenes.

Signal names for mini D-sub 15 pin connector

Pin assignment for RGB/PC terminal



Pin No.	Signal name	Pin No.	Signal name
1	R	9	VGA-5V
2	G	10	Ground
3	B	11	NC (not connected)
4	NC (not connected)	12	VGA-SDA
5	NC (not connected)	13	H-sync
6	Ground	14	V-sync
7	Ground	15	VGA-SCL
8	Ground		

Using the PC setting

- First press \odot to display the video input mode list, then press ∇ or \triangle and \odot in order to select the PC input mode (see page 23).
- This function may not be available for some signal or if no signal is received.
- The optimum points of the clock phase and sampling clock adjustments may be incomprehensible according to the input signals.

Adjusting the picture size/position, the clock phase of the picture and sampling clock

- 1 Press \odot , then press \triangleleft or \triangleright to display the **PICTURE** menu, then press \odot .
- 2 Press ∇ or \triangle to select **VGA Set** menu.

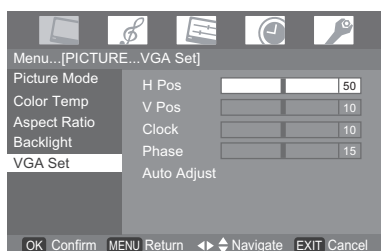

- 3 Press \odot or \triangleright to select an option you want to adjust. Press \triangleleft or \triangleright to adjust the settings as required.

PC of the Auto Adjust

Adjust Horizontal Position, Vertical Position, Horizontal Clock, and Clock Phase automatically. Depending on the type of the signal, there is a possibility that the display may not be adjusted in its optimum condition with this function. In that case, please adjust each item manually.

- 1 Press \odot , then press \triangleleft or \triangleright to display the **PICTURE** menu, then press \odot .
- 2 Press ∇ or \triangle to select **VGA Set** menu.

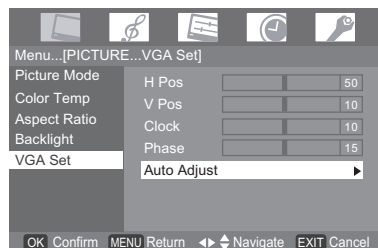



- 3 Press \odot and press ∇ to select **Auto adjust**.
- 4 Press \triangleright .

Troubleshooting

Before calling a service technician, please check the following table for a possible cause of the symptom and some solutions.

Symptom and solution



TV will not turn on

- Make sure the power cord is plugged in, then press  or .
- The remote control batteries may be dead. Replace the batteries.

No picture, no sound

- Check the antenna connections.

No sound, picture OK

- The sound may be muted. Press ,  or .
- The station may have broadcast difficulties. Try another channel.

Poor sound, picture OK

- The station may have broadcast difficulties. Try another channel.

Poor picture, sound OK

- Check the antenna connections.
- The station may have broadcast difficulties. Try another channel.
- Adjust the **PICTURE** menu.

Poor reception of broadcast channels

- Check the antenna connections.
- The station may have broadcast difficulties. Try another channel.
- Make sure the Color system is properly set.

Teletext problems

- Check the antenna connections.
Good performance of text depends on a good strong broadcast signal.

Multiple images

- The station may have broadcast difficulties. Try another channel.
- Antenna reception may be poor. Use a high directional outdoor antenna.
- Check if the direction of the antenna has changed.

Poor color or no color

- The station may have broadcast difficulties. Try another channel.
- Adjust the **Tint** and/or **Color** in the **PICTURE** menu.

The remote control does not operate

- Remove all obstructions between the remote control and the remote control sensor on the TV.
- The remote control batteries may be dead. Replace them with new ones.
- Check that the TV/STB/DVD switch on the remote control is properly set.

Some pixels of the screen do not light up

- The LCD display panel is manufactured using an extremely high level of precision technology, however, sometimes some pixels of the screen may be missing picture elements or have luminous spots. This is not a sign of a malfunction. batteries.

The picture brightness varies when you switch the TV on.

- If you switch the TV on at 0°C and under, wait until the warms up.

The brightness of the screen comes down, or flickers of the screen are caused, or some parts of the screen do not light up.

- When you just buy and start to use this TV, a flickering may be caused in the screen. In this case, switch off the TV, then switch on it again to cure the condition.
- The cold cathode fluorescent lamp used for the back light on this TV has longevity. When the brightness of the screen comes down, or the flickers of the screen are caused, or some parts of the screen do not light up, it may reach the end of its life. Contact a service technician.

Symptom and solution - digital only -



Poor picture

- Check the antenna connections. Make sure it is aligned to the correct broadcast direction.
- Check the signal level and quality in the **Manual Search** menu.
- If you use any kind of amplifier to boost the signal level, check whether it works well, and ask for help from the antenna installer.

No picture

- Use the **Manual Search** menu to rescan this channel.
- Try another channel.
- Reduce **RF** amplifier gain if connected to **RF** booster.

No sound from DIGITAL AUDIO

- The sound may be muted. Press ,  or .
- Make sure the TV is adjusted to the correct Audio Track.
- Use the Manual Search menu to rescan this channel.
- Try another channel.

Not all channels are available after using the Full Search when tuning the TV for the first time.

- This symptom is caused by unexpected frequency offset.
- The **Manual Search** menu to scan for the missing channels. The TV scan receive these channels by the **Full Search** menu most of the time, but we suggest that you use the **Manual Search** menu when tuning the TV for the first time. Once the TV picks up the signal, all the transmission parameters will be stored in the internal memory.

Cannot lock signal by using Manual Search

- Check the frequency that you have entered is exactly the Middle frequency of the wanted channel.
- Refer to the solutions for "Poor picture".

No Teletext, no Subtitle

- Make sure the channel that you are watching carries Teletext/Subtitle information from .

Cannot receive channels after moving the TV between cities (e.g. from Melbourne to Sydney)

- Refer to page 13 to reset data.

Weak signal appears on one channel but not the other, but these channels have the same logical number

- Please make sure that you do not keep duplicate channels (i.e. channels with the same logical channel number but different physical numbers, see page 13). If you do, please delete the duplicate ones and keep only one channel with the best signal strength.

Program Timer and Alarm do not operate properly.

- Check the antenna connections.
- Weak signal may cause inaccurate time information.

APPENDIX

AUSTRALIAN PARENTAL GUIDANCE CODES (Normative)

Recommended On-Screen-Display for parental guidance codes transmitted within DVB-SI EIT information using the DVB parental_rating_descriptor.

			Receiver Menu Set-up and Suggested OSD wording for Setting Blocking (Restriction of access)							
			Block All	Block G and above (optional)	Block PG and above	Block M and above	Block MA and above	Block AV and above	Block R and above	No Block
Transmitted rating hex code	Australian parental guide code	On-Screen- Display	Resultant receiver action to received hex code ✓ is show program - ✗ is block until PIN entered							
0 x 00	Not Classified	-	✗	✓	✓	✓	✓	✓	✓	✓
0 x 01		-	✗	✓	✓	✓	✓	✓	✓	✓
0 x 02	P Pre school	P	✗	✓	✓	✓	✓	✓	✓	✓
0 x 03		P	✗	✓	✓	✓	✓	✓	✓	✓
0 x 04	C Children's	C	✗	✓	✓	✓	✓	✓	✓	✓
0 x 05		C	✗	✓	✓	✓	✓	✓	✓	✓
0 x 06	G General	G	✗	✗	✓	✓	✓	✓	✓	✓
0 x 07		G	✗	✗	✓	✓	✓	✓	✓	✓
0 x 08	PG Parental Guidance Recommended	PG	✗	✗	✗	✓	✓	✓	✓	✓
0 x 09		PG	✗	✗	✗	✓	✓	✓	✓	✓
0 x 0A	M Mature Audience 15+	M	✗	✗	✗	✗	✓	✓	✓	✓
0 x 0B		M	✗	✗	✗	✗	✓	✓	✓	✓
0 x 0C	MA Mature Adult Audience 15+	MA	✗	✗	✗	✗	✗	✓	✓	✓
0 x 0D		MA	✗	✗	✗	✗	✗	✓	✓	✓
0 x 0E	AV Adult Audience, Strong violence 15+	AV	✗	✗	✗	✗	✗	✗	✓	✓
0 x 0F	R Restricted 18+	R	✗	✗	✗	✗	✗	✗	✗	✓

Broadcast system

Broadcast transmission systems of each country or region

Asia M.E.

Country or region	Color	Sound
Bahrain, Kuwait, Israel, Oman, Qatar, United Arab Emirates, Yemen, etc. Indonesia, Malaysia, Singapore, Thailand, etc.	PAL	B/G

Oceania

Country or region	Color	Sound
Australia, New Zealand, etc.	PAL	B/G

Specifications

Integrated Digital LCD TV

Model

26AV500A, 32AV500A, 37AV500A, 42AV500A

Power source

220 V-240 V AC, 50 Hz

Power consumption

26AV500A: 0.9 W (standby)
 32AV500A: 0.9 W (standby)
 37AV500A: 0.9 W (standby)
 42AV500A: 0.9 W (standby)

Dimensions

26AV500A: 664 mm (W) 511.4 mm (H) 269 mm (D)
 32AV500A: 790 mm (W) 586.4 mm (H) 308.4 mm (D)
 37AV500A: 910 mm (W) 654 mm (H) 308.4 mm (D)
 42AV500A: 1034 mm (W) 748 mm (H) 341 mm (D)

Mass (Weight)

26AV500A: 12.5 kg
 32AV500A: 18.5 kg
 37AV500A: 22.6 kg
 42AV500A: 27.2 kg

Analog TV system (Antenna input)

Channel coverage:

PAL	B/G	(CCIR)	VHF	0 - 12
			UHF	27 - 69
			CATV	C2, C10, C31, S2 - S44

Digital TV System

Compliant Standard DVB-T
 Video Decoding MP @ ML & MP @ HL
 Audio Decoding Dolby® Digital, MPEG (I & II)
 Audio Sampling Rate 32, 44.1, 48 kHz

Digital TV Terrestrial Tuner / Demodulator

Frequency 51~858 MHz
 Loop Through 51~858 MHz
 Bandwidth 7 MHz
 Demodulator COFDM
 FFT Mode 8 K
 Constellation QPSK, 64 QAM
 Guard Interval 1/8, 1/16
 Inner Coding Rate 2/3, 3/4

COMPONENT VIDEO INPUT terminals (the signal format)

480i, 480p, 576i, 576p, 720p (50/60 Hz), 1080i (50/60 Hz)
 (These signal formats are converted to match the number of pixels of the LCD panel.)

Composite Color system (analog TV system)

PAL, SECAM, NTSC 3.58/4.43

Aspect ratio

16 : 9

Visible size (diagonal)

26AV500A: 66.3 cm
 32AV500A: 80.3 cm
 37AV500A: 99.4 cm
 42AV500A: 107.1 cm

Number of pixels

26AV500A, 32AV500A, 37AV500A, 42AV500A:
 1,366 (H) dots x 768 (V) dots

Audio power

10 W + 10 W (10 % THD)

Speakers

Main 60 x 120 mm 2 pcs.

Input/Output terminals

⊖ (1)	Input RCA Component Video RCA Composite Video Audio : RCA	Y, PB/CB, PR/CR CVBS L/Mono+R (shared between Component and Composite)
⊖ (2)	Input RCA/Mini-Din(4 pin) Composite Video(CVBS) +S-video Audio : RCA	L/Mono+R (shared between S-Video and Composite)
⊕ MONITOR	Output RCA video output Audio out RCA(L+R)	
⊖ RGB/PC	Input Mini D-sub 15 pin Analog RGB	
⊖ PC/HDMI1 (AUDIO)	Input Phone jacks	Audio L+R
⊖ HDMI1	Input(type A) 19 pin	A/V Digital
⊖ HDMI2	Input(type A) 19 pin	A/V Digital
⊕ Digital Audio (optical + coaxial)	Output Bitstream/PCM	
Headphone jack	3.5 mm (Diameter) stereo	

Operating condition

Temperature 0 °C - 35 °C
Humidity 20 % - 80 % (No moisture condensation)

Supplied accessories

Owner's manual (1), Remote control (1), Batteries (2),
Clean Cloth (1)

- Design and specifications are subject to change without notice.
- Never service or remodel the TV by yourself. It may expose you to a fire hazard or dangerous voltages.

Note

Note

Note

TOSHIBA CORPORATION