

# **ZANUSSI**

## **FREEZER ZVR11R**

**INSTRUCTION BOOKLET**

8181502--02/5

# Important Safety Instructions



**These warnings are provided in the interests of your safety.** Ensure that you understand them all before installing or using the appliance. Your safety is of paramount importance. If you are unsure about any of the meanings or warnings contact the Customer Care Department.

Keep the instruction booklet. It will come in handy if you later sell the cabinet or give it to somebody else.

## Prior to Installation

- Check the appliance for transport damage. Under no circumstances should a damaged appliance be installed. In the event of damage please contact your retailer.

## Installation

- This appliance is heavy. Care should be taken when moving it.
- It is dangerous to alter the specifications or attempt to modify this product in any way.
- Ensure that the appliance does not stand on the electrical supply cable. If the supply cable is damaged, it must be replaced by a cable available from your local Service Force Centre.
- Any electrical work required to install this appliance should be carried out by a qualified electrician or competent person.
- Parts which heat up should not be exposed. Whenever possible, the back of the appliance should be close to a wall, but leaving the required distance for ventilation, as stated in the installation instructions.  
The appliance should be left for 2 hours after installation before it is turned on, in order to allow the refrigerant to settle.

## Child Safety

- Do not allow children to tamper with the controls or play with the product.
- There is a risk of suffocation! Keep packaging material away from children.

## During Use

- This appliance is designed for domestic use only, specifically for the storage of edible foodstuffs only.  
It is not intended for commercial or industrial use.
- Containers with flammable gases or liquids can leak at low temperatures. Do not store any containers with flammable materials, such as spray cans, fire extinguisher refill cartridges etc.

in the refrigerator or freezer.

## Maintenance and Cleaning

- Before cleaning, always switch off the appliance and disconnect from the electrical supply
- When unplugging always pull the plug from the mains socket, do not pull on the cable.

## Servicing

- This product should be serviced by an authorised engineer and only genuine spare parts should be used.
- Under no circumstances should you attempt to repair the appliance yourself. Repairs carried out by inexperienced persons may cause injury or serious malfunctioning. Contact your local Service Force Centre.

## At the end of the Appliance Life

- When disposing of your appliance use an authorised disposal site.
- Remove the plug and ensure that any locks or catches are removed, to prevent young children being trapped inside.
- Do not let sharp objects come into contact with the refrigerating system on the back of and inside the cabinet. If the refrigerating system is punctured, the cabinet will be damaged and foodstuff inside may spoil.  
If the refrigerant circuit should become damaged:  
avoid open flames and sources of ignition  
thoroughly ventilate the room in which the appliance is situated  
The refrigerant isobutane (R600a) is contained within the refrigerant circuit of the appliance, a natural gas with a high level of environmental compatibility, which is nevertheless flammable.
- Do not place carbonated or fizzy drinks in the freezer compartment. Bottles and cans must not be placed in the freezer compartment they can burst when the contents freeze.

## Instructions for the user

<b>Important Safety Instructions</b> .....	<b>2</b>
<b>Contents</b> .....	<b>3</b>
<b>Description of the Appliance</b> .....	<b>4</b>
Control Panel .....	4
<b>Use</b> .....	<b>4</b>
To start the freezer and thermostat control .....	5
Switching off .....	5
Freezing .....	5
Alarms and other features .....	6
Suitable storage periods .....	6
Temperature inside the freezer .....	6
Thawing .....	6
Cabinet interior .....	7
<b>Hints and Tips</b> .....	<b>7</b>
Energy Saving Advice .....	7
Food Storage .....	7
Normal Operating Sounds .....	8
<b>Maintenance and Cleaning</b> .....	<b>8</b>
Removing the ventilation grille .....	8
Internal Cleaning .....	8
External Cleaning .....	8
Defrosting the freezer .....	9
To Change the Light Bulb .....	9
When the appliance is not in use .....	9
<b>Something Not Working</b> .....	<b>9</b>
<b>Service and Spare Parts</b> .....	<b>10</b>
<b>Customer Care Department</b> .....	<b>12</b>
<b>Guarantee Conditions</b> .....	<b>13</b>

## Instructions for the installer

<b>Technical specification</b> .....	<b>14</b>
<b>Installation</b> .....	<b>14</b>
Unpacking .....	14
Cleaning .....	14
Installing the cabinet .....	14
Electrical connection .....	15
Door Reversal .....	15

## Guide to use the instruction book

The following Symbols will be found in the text to guide you through the instructions



Safety instructions

1, 2, 3 ...

Step by step instructions for an operation



Hints and tips

# Description of the Appliance

GB

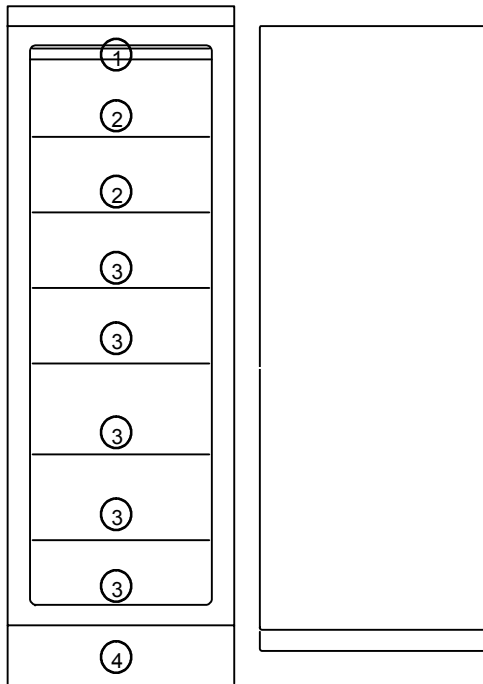

Model ZVR11R

1. freezing tray
2. shelf with flap
3. freezer basket
4. ventilation grille

## Control Panel

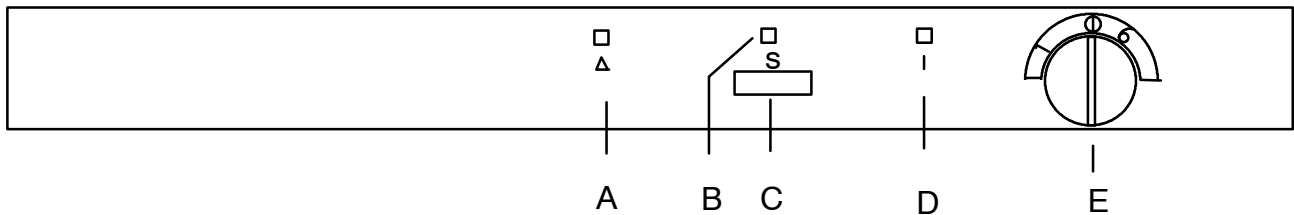

### A. Red warning light

Flashes when one of the alarms in the cabinet has been triggered.

### B. Yellow indicator light

Lights when Fast Freeze is operating.

### C. FAST FREEZE button

Used to switch the Fast Freeze feature on and off.

### D. Green indicator light

Lights when the freezer is operating.

### E. Thermostat control

Use to switch on and set the desired temperature in the freezer.

# Use

GB

## Operation



This appliance is designed for domestic use only, specifically for the storage of edible foodstuffs.

This appliance is designed to operate in ambient temperatures (surrounding air temperature) between 10°C and 32°C.

If these temperatures are exceeded i.e., colder or warmer, the appliance will not operate correctly.

## Before use

·Remove all securing tapes.  
·Wash the inside of the appliance with lukewarm water with a little bicarbonate of soda added (5ml to 0,5 litre of water). Do not use soap or detergent as the smell may linger. Dry the appliance thoroughly.



Do not use detergents, abrasive powders, highly perfumed cleaning products, wax, polishes or products containing alcohol.

·Before inserting the power plug into the outlet and switching on the cabinet for the first time, leave it standing upright for about 30 minutes, or for 4 hours if it was transported horizontally. Otherwise the compressor may sustain damage. This time will allow the oil sufficient time to return to the compressor.

## To start the freezer and thermostat control

1. Plug in the appliance.

Turn the thermostat control to the desired position.

**1** :

The lowest position of the thermostat control results in the highest temperature inside the cabinet.

**6** :

The highest position of the thermostat control results in the lowest temperature inside the cabinet.

**0** :

Off.

Allow the cabinet to run for a period of 24 hours whenever the temperature setting is changed. This will allow the temperature to stabilise inside the cabinet.

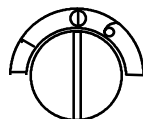

## Switching off

Set the thermostat control to the "0" position.

Unplug the power supply plug from the wall socket or, alternatively, remove the fuse.

## Freezing

You need not press the fast-freezing button when freezing smaller quantities of food during any 24-hour period.

In all other cases, press the fast-freezing button approx. 24 hours prior to placing the food in the freezer.

Press the fast-freezing button to switch off fast-freezing again about 24 hours after placing the food in the freezer.

The yellow fast-freezing lamp remains lit as long as the fast-freezing button is engaged.

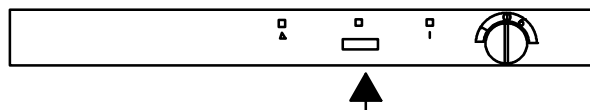

### Practical advice on freezing

- When freezing products, use the top shelf, and if necessary the shelf beneath that.
- Place the foods directly on the freezer shelves.
- Spread out the products as much as possible to allow air to circulate between them.
- Do not place food products which are to be frozen directly against other frozen food. The heat from the unfrozen food may cause the frozen food to thaw on the surface.
- Once frozen, re-arrange the products and put them as close as possible to each other. The food will then stay cold longer in the event of a power failure.
- Do not freeze too much food at the same time. The freezing capacity of the unit is indicated in the specifications section.

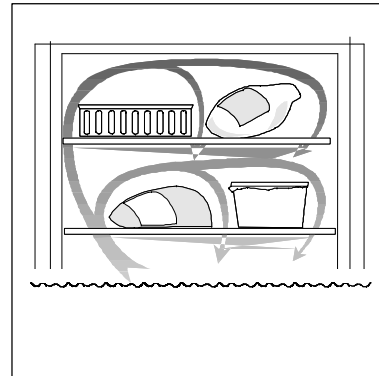

### Alarms and other features

#### Temperature alarm

A red warning lamp lights if it gets warmer than  $-12^{\circ}\text{C}$ . Find out what caused the alarm and correct the situation. The lamp goes out when it becomes colder than  $-13^{\circ}\text{C}$ .

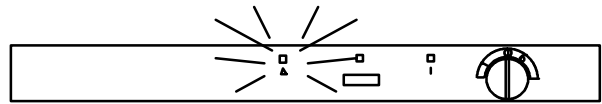

#### Suitable storage periods

Food purchased in frozen condition: Follow the advice on the maximum storage period indicated on the packaging.

Food frozen at home:

Fatty and salty food should not be kept frozen for more than three months. Cooked food and low-fat food may be kept up to about six months. Lean food and berries can be kept for approximately one year.

#### Temperature inside the freezer

To ensure that foodstuff will keep for a long time, be sure that the temperature inside the freezer is  $-18^{\circ}\text{C}$  or below. Please note, however, that the energy consumption increases as the temperature decreases.

#### Thawing

It is best to use a fridge to thaw food. Place the foodstuff on a plate with a raised edge to prevent liquids from running out. To quickly thaw food, put it in room temperature or in cold water. When using a microwave oven to thaw foodstuffs, follow the manufacturer's instructions.

## Cabinet interior

### Freezer drawers

The freezer drawers make it easy to quickly and easily find the food package you want. To gain space, the drawers can be removed and the products can be put directly on the shelves. On all shelves, except the top shelf, it is possible to place products that protrude 20 mm from the front edge. This allows maximum use of the available space.

Do not remove the bottom drawer. It is required to assure proper air circulation.

### Ice cubes

Fill the ice tray to max. 3/4 since water expands as it freezes. Release the ice cubes by twisting the ice tray.

If ice cubes are kept for a long time, they will dry out and the taste is affected. Thus, throw away old ice cubes and prepare new ones when needed.

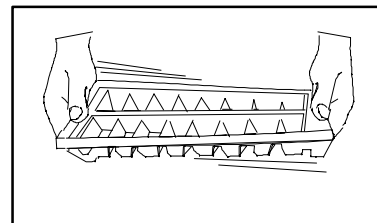
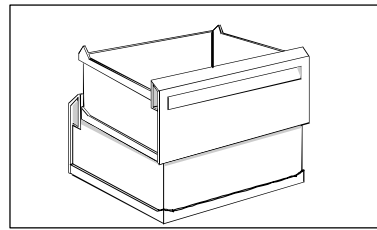

## Hints and Tips



### Energy Saving Advice

- Do not install the cabinet close to sources of heat such as a cooker, dishwasher or radiator.
- Locate the appliance in a cool well ventilated room and make sure that the air openings of the cabinet are not obstructed.
- Always leave warm food to cool down to room temperature before placing in the fridge.
- Try to avoid keeping the door open for long periods, or opening the door too frequently as warm air will enter the cabinet, and cause the compressor to switch on unnecessarily often.
- Ensure there are no obstructions preventing the door from closing properly.
- It is advisable to periodically clean the refrigeration system at the back of the appliance with a duster or vacuum cleaner.
- Avoid unnecessary frosting in the cabinet by packing all foodstuffs into airtight packages before placing them in the freezer.
- Carefully follow the advice on freezing products in the section "Use". This will prevent wasting energy.
- Do not set the temperature too low in the freezer. A suitable temperature is in the range of -18°C to -20°C .
- Defrost the freezer when the frost layer reaches a thickness of 3-5 mm. Regularly check the door seal to ensure that it is clean and free from debris.
- Make sure the door gasket is complete and always clean.

### Food Storage

- Avoid buying frozen food if you can not store it straight away. The use of an insulated container is advisable. When you arrive home place the frozen food in the freezer immediately.
- Ensure that food placed in the freezer is dated and labelled and used in date order to ensure that food is consumed at its best. Remove suspect food from you refrigerator and clean, refer to cleaning and maintenance.
- In the event of a power failure causing the temperature within your freezer to rise, do not refreeze the food without checking its condition. The following guidelines should assist you.
  - Ice-cream:** once thawed should be discarded.
  - Fruits & Vegetables:** if soft should be cooked and used up.
  - Breads & Cakes:** can be re-frozen without danger.
  - Shellfish:** should be refrigerated and used up quickly.
  - Cooked Dishes:** i.e. casseroles should be refrigerated and used up
  - Large Pieces of Meat:** can be re-frozen providing there are still ice crystals remaining within them.
  - Small Joints:** should be cooked and can then be refrozen as cooked dishes.
  - Chicken:** should also be cooked and re-frozen as a cooked dish.

## Normal Operating Sounds

- You may hear faint gurgling or bubbling sounds when the refrigerant is pumped through the coils or tubing at the rear, to the cooling plate/evaporator.
- When the compressor is on, the refrigerant is

being pumped round, and you will hear a whirring sound or pulsating noise from the compressor.

- A thermostat controls the compressor and you will hear a faint "click" when the thermostat cuts in and out.

# Maintenance and Cleaning



Before any maintenance or cleaning work is carried out DISCONNECT the appliance from the ELECTRICITY supply

## Removing the ventilation grille

The ventilation grille can be removed, e.g. to wash the grille.

Make sure the door is open when removing the ventilation grille. Unsnap the upper edge of the grille by pulling outward/downward. Then pull the grille straight out to completely remove it.

## Internal Cleaning

Clean the inside and the accessories with warm water and bicarbonate of soda (5 ml to 0,5 litre of water).

Rinse and dry thoroughly.

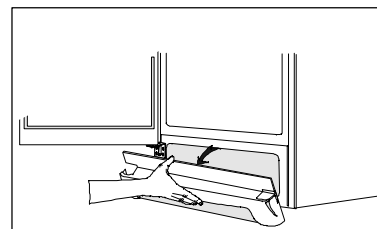

Do not use detergents, abrasive powders, high perfumed cleaning products, wax polishes or cleaning products containing bleach or alcohol .

Regularly check the door seals and wipe clean to ensure they are clean and free from debris.

## External Cleaning

Wash the outer cabinet with warm soapy water. Remove the ventilation grille (see the section "Removing the ventilation grille") and vacuum-clean under the cabinet. Once or twice a year dust the condenser (black grille) and the compressor at the back of the appliance, with a brush or vacuum cleaner, as an accumulation of dust will affect the performance of the appliance and cause excessive electricity consumption.

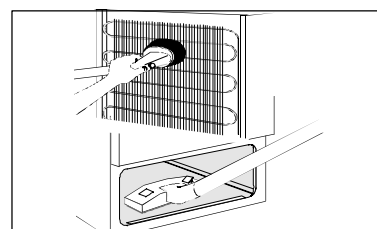
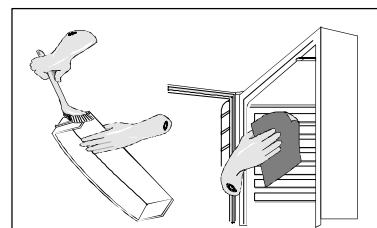

When moving the cabinet, lift it by the front edge to avoid scratching the floor.



## Defrosting the freezer

A certain amount of frost will always form on the freezer shelves and around the top compartment. Defrost the freezer when the frost layer reaches a thickness of about 3-5 mm.

Remove the freezer drawers and place them on top of each other by turning every other drawer one half turn. Put insulating material around the drawers, e.g. blankets or newspapers.

The frozen products can also be packed closely together and be kept in a cold location, e.g. in the fridge.

Defrosting can be accelerated by placing bowls with hot water (not boiling) inside the freezer.

Take out the drain spout and place it in the bottom freezer drawer where water can collect.

Loosen the ventilation grille to enable the bowl to fit under the drain spout.

Carefully scrape off the ice when it starts to thaw.

Use a wood or plastic scraper. Do not use sharp objects as these may damage the interior.

When all the ice has melted, clean and wipe the cabinet dry, then push the drain spout back in place.

Switch on the cabinet and replace the frozen foodstuff.

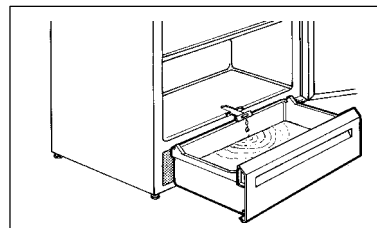
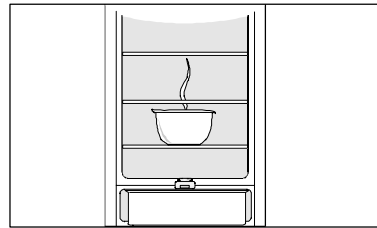
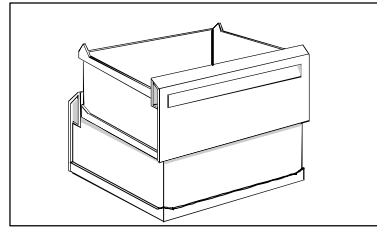

Never use a hair dryer or other heating appliances to speed up defrosting. Excessive heat may damage the plastic interior, and humidity could enter the electric appliance making it live.

## To Change the Light Bulb

The light is switched on automatically when the door is opened. Before replacing the light bulb, disconnect the power plug from the outlet.

To replace the lamp in the chiller compartment (only cabinets with two doors), first unscrew the lamp grille with a screwdriver.

Use a bulb of the same type, E14 socket, maximum rating of 25 W.

## When the appliance is not in use

Disconnect the appliance from electricity supply.

Empty all foods and clean the appliance, leaving the doors ajar to prevent unpleasant smells.

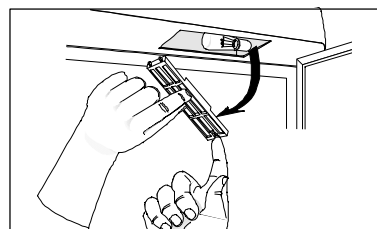

# Something Not Working

Before contacting your local Service Force Centre check the following points:

Symptom	Solution
<b>The temperature is too high inside the freezer.</b>	Set a lower temperature. Make sure that the door is completely closed and that the rubber gasket is complete and clean. If warm food products have been put inside the freezer, wait for a couple of hours and then check the temperature again. Distribute the food products to allow cold air to circulate around them.
<b>The temperature is too low inside the freezer.</b>	Set a higher temperature. Fast Freeze could have been switched on.
<b>Too much frost and ice are produced.</b>	Make sure that the door is completely closed and that the rubber gasket is complete and clean. Set a higher temperature.
<b>The compressor operates continuously.</b>	Set a higher temperature. Make sure that the door is completely closed and that the rubber gasket is complete and clean. The temperature where the cabinet is placed is above normal room temperature.
<b>The cabinet does not operate at all. Cooling or interior light does not operate. No indicator lamps light.</b>	The power plug is not properly connected. The fuse has blown. The cabinet is not switched on. Power does not reach the cabinet. (Try connecting another electrical device to the power outlet.)
<b>Power failure</b>	Do not unnecessarily open the cabinet, except when the power outage seems to be long, in which case the food products should be moved to another cabinet that works. See the chapter "Hints and Tips".
<b>Noise</b>	See "Normal operating Sounds" in chapter Hints and Tips.
<b>The freezer door will not open</b>	Has door just been opened? If so leave for few minutes to allow the air pressure to equalise.

If after above checks there is still a fault call your local Service Force Centre.

In-guarantee customers should ensure that the above checks have been made as the engineer will make a charge if the fault is not a mechanical or electrical breakdown.

Please note that proof of purchase is required for in-guarantee service calls.

# Service and Spare Parts



In the event of your appliance requiring service, or if you wish to purchase spare parts please contact your local Zanussi Service Force Centre by telephoning:

**0870 5 929929**

Your telephone call will be automatically routed to the Service Force Centre covering your post code area. The addresses are listed on the following pages.

Before calling out an engineer, please ensure you have read the details under the heading "Something Not Working".

When you contact the Service Force Centre you will need to give the following details:

1. Your name, address and post code
2. Your telephone number
3. Clear and concise details of the fault
4. The model and serial number of the appliance (found on the rating plate)
5. The purchase date.....

# Customer Care Department



For general enquiries concerning your Zanussi appliance or further information on Zanussi products, please contact our Customer Care Department by letter or phone at the address below or visit our website at [www.zanussi.co.uk](http://www.zanussi.co.uk)

Customer Care Department

Zanussi

55-77 High Street

Slough

Berkshire

SL1 1DZ

08705 727727(\*)

\* calls to this number may be recorded for training purposes.



# Zanussi Service Force



To contact your local Zanussi Service Center telephone **08705 929 929**

<b>MIDLANDS</b> BIRMINGHAM (M18) 66 Birch Road East, Wyrley Road Ind Estate Witton Birmingham B6 6DB	<b>LONDON &amp; EAST ANGLIA</b> BECKENHAM (M79) 11A Gardener Ind Estate Kent House Lane Beckenham Kent BR3 1QZ	NORWICH (M52) 2b Trafalgar Street Norwich NR1 3HN
BOURNE (M44) Manning Road Ind Estate Pinfold Road Bourne PE10 9HT	CHELMSFORD (M47) Hanbury Road Widford Ind Estate Chelmsford Essex CM12 3AE	SUNBURY (M63) Unit 1a The Summit Hanworth Road Hanworth Ind Estate Sunbury on Thames TW16 5D
BRIDGNORTH (M72) 68 St. Mary's Street Bridgnorth Shropshire WV16 4BB	COLINDALE (M53) Unit 14 Capitol Park Capitol Way Colindale London NW9 0EQ	<b>SOUTH EAST</b> ASHFORD (M58) Unit 2 Bridge Road Business Estate Bridge Road Ashford Kent TN2 1BB
GLOUCESTER (M23) 101 Rycroft Street Gloucester GL1 4NB	ELTHAM (M78) 194 Court Road Mottingham Eltham London SE9 4EW	FLEET (M59) Unit 1 Redfields Industrial Estate Church Crookham Fleet Hampshire GU13 0RD
HEREFORD (M31) Unit 3 Bank Buildings Cattle Market Hereford HE4 9HX	ENFIELD (M49) 284 Alma Road Enfield London EN3 7BB	HAYWARDS HEATH (M55) 21-25 Bridge Road Haywards Heath Sussex RH16 1UA
HIGHAM FERRERS (M51) 30 High Street Higham Ferrers Northants NN10 8BB	GRAVESEND (M57) Unit B4, Imperial Business Estate Gravesend Kent DA11 0DL	<b>SOUTH WEST</b> BARNSTAPLE (M30) Main Road Fremington Barnstaple North Devon EX31 2NT
ILKESTON (M43) Unit 2 Furnace Road Ilkeston DE7 5EP	HARPENDEN (M46) Unit 4 Riverside Estate Coldharbour Lane Harpenden AL5 4UN	BOURNEMOUTH (M26) 63-65 Curzon Road Bournemouth Dorset BH1 4PW
LEICESTER (M22) Unit 7 Oaks Ind. Estate Coventry Road Narborough Leicestershire LE0 5GF	LETCHWORTH (M50) 16-17 Woodside Ind Estate Works Road Letchworth Herts SG6 1LA	BRIDGEWATER (M35) 6 Hamp Industrial Estate Bridgewater Somerset TA6 3NT
LINCOLN (M40) Unit 8 Stonefield Park Clifton Street Lincoln LN5 8AA	LONDON (M76) 2/4 Royal Lane Yiewsley West Drayton Middlesex UB7 8DL	BRISTOL (M25) 11 Eldon Way Eldonwall Trading Bristol Avon BS4 3QQ
NEWCASTLE UNDER LYME (M12) 18-21 Croft Road Brampton Ind. Estate Newcastle under Lyme Staffordshire ST5 0TW	MAIDENHEAD (M60) Reform Road Maidenhead Berkshire SL6 8BY	EMSWORTH (M33) 266 Main Road Southbourne Emsworth PO10 8JL
REDDITCH (M20) 13 Thornhill Road North Moons Moat Redditch Worcestershire B98 9ND	MOLESEY (M61) 10 Island Farm Avenue West Molesey Surrey KT8 2UZ	ISLE OF WIGHT (M34) Unit 8 Enterprise Court Ryde Business Park Ryde Isle of Wight PO33 1DB
TAMWORTH (M19) Unit 3 Sterling Park Claymore Tamworth B77 5DO	NEWBURY (M24) 9 Pipers Court Berkshire Drive Thatcham Berkshire RG14 4ER	NEWTON ABBOT (M29) Unit 2 Zealley Industrial Estate Kingsteignton Newton Abbot S. Devon TQ12 3TD
WORCESTER (M73) Unit 1 & 2 Northbrook Close Gregorys Mill Ind Estate Worcester WR3 8BP	IPSWICH (M48) Unit 6C Elton Park Business Centre Hadleigh Road Ipswich IP2 0DD	REDRUTH (M36) Unit 7D Pool Ind. Estate Wilson way Redruth Cornwall TR15 3QW

To contact your local Zanussi Service Center telephone **08705 929 929**

<b>CHANNEL ISLAND</b> GUERNSEY	Guernsey Electricity PO Box 4 Vale, Guernsey Channel Islands	<b>KELSO</b> (M08)	2-8 Wood Market Kelso Borders TD5 7AX	<b>NORTH EAST</b> <b>GATESHEAD</b> (M39)	Unit 356a Dukesway Court Dukesway Team Valley Gateshead NE11 0BH
<b>JERSEY</b>	Jersey Electricity Company PO Box 45 Queens Road St Helier Jersey Channel Islands JE4 8NY	<b>ORKNEY</b> (M65)	Corsie Domestics 7 King Street Kirkwall Orkney KW15	<b>GRIMSBY</b> (M42)	15 Hainton Avenue Grimsby South Humberside DN32 9AS
<b>SCOTLAND</b> <b>ABERDEEN</b> (M05)	54 Claremont Street Aberdeen AB10 6RA	<b>PERTH</b>	Hydro Electric Inveralmond House Ruthvenfield Road Perth PH1 3AQ	<b>HULL</b> (M41)	Unit 1 Boulevard Industrial Estate Hull HU3 4AY
<b>AUCHTERMUCHY</b> (M03)	33a Burnside Auchtermuchy Fife KY14 7AJ	<b>PERTH</b> (OWN SALES)	Graham Begg Unit 4 Airport Ind Estate Wick KW1 4QS	<b>LEEDS</b> (M37)	64-66 Cross Gates Road Leeds LS15 7NN
<b>BLANTYRE</b> (M07)	Unit 5 Block 2 Auchenraith Ind Estate Rosendale Way Blantyre G72 0NJ	<b>SHETLAND</b> (OWN SALES)	Tait Electronic Systems Ltd. Holmsgarth Road Lerwick Shetland ZE1 0PW	<b>NEWTON AYCLIFFE</b> (M45)	Unit 16 Gurney Way Aycliffe Ind Estate Newton Aycliffe DL5 6UJ
<b>DUMFRIES</b> (M01)	93 Irish Street Dumfries Scotland DG1 2PQ	<b>SHETLAND</b> (OWN SALES)	Bolts Shetland Ltd 26 North Road Lerwick Shetland ZE1 0PE	<b>SHEFFIELD</b> (M38)	Pennine House Roman Ridge Ind. Roman Ridge Road Sheffield S9 1GB
<b>DUNOON</b> (M67)	Briar Hill 7 Hill Street, Dunoon Argyll PA23 7AL	<b>WHALSAY</b> (OWN SALES)	Leask Electrical Harlsdale Symbister, Whalsay Shetland ZE2 9AA	<b>NORTH EAST</b> <b>BIRKENHEAD</b> (M11)	1 Kelvin Park Dock Road Birkenhead L41 1LT
<b>GLASGOW</b> (M04)	20 Cunningham Road Clyde Estate Rutherglen, Glasgow, G73 1PP	<b>NORTHERN IRELAND</b>		<b>CARLISLE</b> (M10)	Unit 7 James Street Workshops James Street Carlisle Cumbria CA2 5AH
<b>BELFAST</b> (M27)	Owenmore House Kilwee Business Park Upper Dunmury Lane Belfast BT17 0HD	<b>WALES</b> <b>CARDIFF</b> (M28)	Guardian Industrial Estate Clydesmuir Road Tremorfa Cardiff CF2 2QS	<b>ISLE OF MAN</b> (M64)	South Quay Ind Estate Douglas Isle of Man IM1 5AT
<b>INVERNESS</b> (M06)	Unit 3B Smithton Ind Estate Smithton Inverness IV1 AJ	<b>CLYWD</b> (M14)	Unit 6-7 Coed - Parc Abergele Road Rhuddlan Clwyd Wales LL18 5UG	<b>LIVERPOOL</b> (M15)	Unit 1 Honeys Green Precinct Honeys Green Lane Liverpool L12 9JH
<b>ISLE OF ARRAN</b> (OWN SALES)	Arran Domestics Unit 4 The Douglas Centre Brodict Isle of Arran KA27 8AJ	<b>DYFED</b> (M77)	Maes Y Coen High Mead Llanybydder Carmarthenshire SA40 9UL	<b>MANCHESTER</b> (M09)	Unit B Central Industrial Estate St Marks Street Bolton BL3 6NR
<b>ISLE OF BARRA</b> (OWN SALES)	J Zerfah 244 Bruernish Isle of Barra Western Islands HS9 5QY	<b>HAVERTFORDWEST</b> (M75)	Cromlech Lodge Ambleton Haverfordwest Pembrokeshire SA62 5DS	<b>PRESTON</b> (M13)	Unit 250 Dawson Place Walton Summit Bamber Bridge Preston Lancashire PR5 8AL
<b>ISLE OF BUTE</b>	Walker Engineering Glenmhor Upper Serpentine Road Rothesay Isle of Bute PA20 9EH	<b>OSWESTRY</b> (M17)	Plas Ffynnon Warehouse Middleton Road Oswestry SY11 2PP	<b>STOCKPORT</b> (M16)	Unit 20 Haigh Park Haigh Avenue Stockport SK4 1QR
<b>ISLE OF LEWIS</b>	ND Macleod 16 James Street Stornoway Isle of Lewis PA87 2QW				

# Guarantee Conditions



We, undertake that if within 12 months of the date of the purchase this appliance or any part thereof is proved to be defective by reason only of faulty workmanship or materials, we will, at our option repair or replace the same FREE OF CHARGE for labour, materials or carriage on condition that:

- The appliance has been correctly installed and used only on the electrical supply stated on the rating plate.
- The appliance has been used for normal domestic purposes only, and in accordance with the manufacturer's instructions.
- The appliance has not been serviced, maintained, repaired, taken apart or tampered with by any person not authorised by us.
- All service work under this guarantee must be undertaken by a ZANUSSI SERVICE CENTRE.
- Any appliance or defective part replaced shall become the company's property.
- This guarantee is in addition to your statutory and other legal rights.

Home visits are made between 8.30am and 5.30pm Monday to Friday. Visits may be available outside these hours in which case a premium will be charged.

## Exclusions

This guarantee does not cover:

- Damage or calls resulting from transportation, improper use or neglect, the replacement of any light bulbs or removable parts of glass or plastic.
- Costs incurred for calls to put right an appliance which is improperly installed or calls to appliances outside the United Kingdom.
- Appliances found to be in use within a commercial environment plus those those which are subject to rental agreements.
- Products of Zanussi manufacture which are not marked by Zanussi.

## European Guarantee

If you should move to another country within Europe then your guarantee moves with you to your new home subject to the following qualifications:

- The guarantee starts from the date you first purchased your product.
- The guarantee is for the same period and the same extent for labour and parts as exists in the new country of use for this brand or range of products.
- This guarantee relates to you and cannot be transferred to another user
- Your new home is within the European Community (EC) or European Free Trade Area.
- The product is installed and used in accordance with our instructions and is only used domestically, i.e. a normal household.
- The product is installed and taking into account regulations in your new country.

Before you move please contact your nearest Customer Care Centre, listed below, to give them details of your new home. They will then ensure that the local Service Organisation is aware of your move and able to look after you and your appliances.

France	Senlis	+33 (0)3 44 62 22 22
Germany	Nürnberg	+49 (0)911 323 26 00
Italy	Prodenone	+39 (0)1678 47053
Sweden	Stockholm	+46 (0) 20 78 77 55
UK	Slough	+44(0) 1753 21 98 97

model	ZVR11R
net volume	293 l
width	595 mm
height	1800 mm
depth	600 mm
energy consumption	431 kWh/year
energy class	B
rated power	120 W
weight	72 kg
freezing capacity	28 kg/24 hours
number of compressors	1

## Installation

### Unpacking

Unpack the cabinet and check that it is in good condition and free of any transport damage. Notify the dealer immediately of any damage. Hand the packaging over for recycling.

### Cleaning

Wash the inside of the cabinet using lukewarm water and bicarbonate of soda (5 ml to 0,5 litre of water).

### Installing the cabinet

To obtain the best performance from the cabinet, ensure :

- the cabinet is placed in a dry, cool place and is not exposed to direct sunlight.
- the cabinet is not placed close to a source of heat, e.g. a cooker or dishwasher.
- the room in which the cabinet is placed has a temperature of +10°C to +32°C.
- the cabinet is level. The cabinet should not lean against any wall. If necessary adjust the feet using the supplied adjustment spanner.
- there is good air circulation around the cabinet and that the air channels below and behind the cabinet are not blocked. The ventilation space above the cabinet and any grocery/top cabinet must be at least 200 cm<sup>2</sup>.

The ventilation space can either be

- directly above the cabinet, or
- behind and above the top cabinet. In this case, the space behind the cabinet must be at least 50 mm deep.



Do not allow children to play with the packaging. The plastic film can cause suffocation.

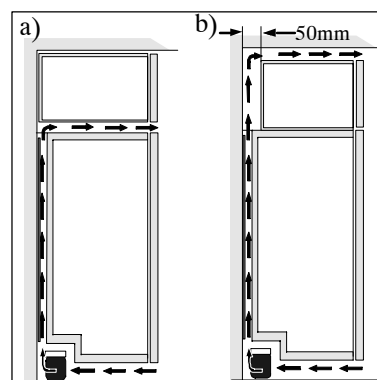
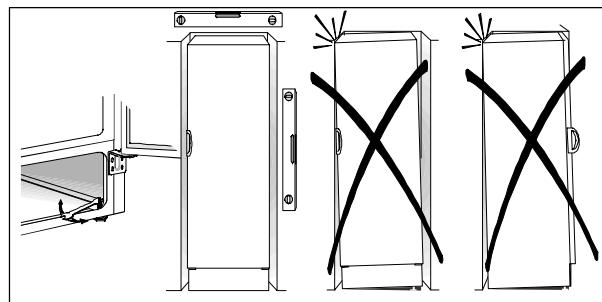

If the cabinet is placed in a corner and the side with the hinges faces the wall, the distance between the wall and the cabinet must be at least 10 mm to allow the door to open enough so that the shelves can be removed.

## Electrical connection



Any electrical work required to install this appliance should be carried out by a qualified electrician or competent person. This appliance must be earthed.

**The manufacturer declines any liability should these safety measures not be observed.**

### Electrical Requirements

Before switching on, make sure the electricity supply voltage is the same as that indicated on the appliance rating plate.

The appliance is supplied with a 13amp plug fitted. In the event of having to change the fuse in the plug supplied, a 13amp ASTA approved (BS1362) fuse must be used.

Should the plug need to be replaced for any reason. The wires in the mains lead are coloured in accordance with the following code:

Green and yellow	-Earth
Blue	-Neutral
Brown	-Live

### Door Reversal

1. Close the cabinet and pull out the plug from the electrical outlet.
2. Remove the ventilation grille. There is a part on the grille that can be removed. Remove it and transfer to the opposite side.
3. Support the cabinet on a wooden block when it is laid down. It will be easier to grip under the cabinet when resupporting to an upright position.
4. On the upper part of the cabinet. Put the hinge pin on the other side.
5. On the lower part of the cabinet. Unscrew the hinge. Move the hinge pin and plastic cover. Secure the hinge on the other side.
6. Raise the cabinet and replace the ventilation grille.
7. Unscrew the handle. Carefully press in the plastic plugs on the opposite side using a punch. Secure the handle in the plug holes. Then press the supplied plastic plugs into the holes to which the handle was previously fitted.
8. Put the cabinet in position. Check that it stands straight. See the section "Positioning the cabinet".

The wire coloured green and yellow must be connected to the terminal marked with the letter "E" or by the earth symbol  or coloured green and yellow.

The wire coloured blue must be connected to the terminal marked "N" or coloured black

The wire coloured brown must be connected to the terminal marked "L" or coloured red.

Upon completion there must be no cut, or stray strands of wire present and the cord clamp must be secure over the outer sheath.

