



ESSENT

EWP-2000 V2 USER'S MANUAL

P/N: M21501-01A3

Table of Contents

<u>EWP-2000 V2 USER'S MANUAL</u>	1
<u>TABLE OF CONTENTS</u>	2
<u>PRODUCT INTRODUCTION</u>	4
ABOUT THIS MANUAL	4
RECORD YOUR SERIAL NUMBER	4
MANUAL DISCLAIMERS	4
REGULATORY NOTICES	4
FCC Class B Radio Frequency Interference Statement	4
CE (EU) Declaration of Conformity	4
Modifications	4
WARNINGS AND PRECAUTIONS	5
Special Battery Cautions	5
Danger of explosion if battery is incorrectly replaced.	5
Rechargeable Lithium-ion battery disposal	5
EWP-2000 V2 Case	5
CARING FOR THE EWP-2000 V2	5
Guidelines for Travel	5
Operating Temperatures and Environments	5
TRADEMARKS & SERVICE MARKS	5
WARRANTY INFORMATION	6
ESCIENT PRIVACY POLICY	7
CONTACT INFORMATION	7
COPYRIGHT	7
TERMS AND DEFINITIONS	7
<u>SETTING UP THE WEB PAD</u>	7
REQUIREMENTS	7
PACKAGE CONTENTS	7
UNPACKING THE EWP-2000 V2	7
ADMINISTRATOR ACCOUNT PASSWORD	7
POWERING STATES	8
Powering On the EWP-2000 V2 from "Power Off" Mode	8
Powering Off the EWP-2000 V2 to "Standby" Mode	8
Powering On the EWP-2000 V2 from "Standby" Mode	8
FRONT PANEL OVERVIEW	8
REAR PANEL OVERVIEW	8
USING THE DOCKING CRADLE	8
WIRELESS NETWORK CARD AND ANTENNA SYSTEM	9
USING THE WEB INTERFACE	9
ENTERING TEXT WITH THE ON SCREEN KEYBOARD	9
WINDOWS SYSTEM KEY COMBINATIONS	9
CALIBRATING THE SCREEN	9
ADJUSTING THE BACKLIGHT LEVEL	9
CONNECTING TO YOUR WIRELESS NETWORK	10
<u>CONNECTING TO YOUR FIREBALL</u>	10
SELECTING YOUR FIREBALL SERVER	10
MANUALLY CONNECTING TO YOUR FIREBALL	10
<u>FIREBALL WEB INTERFACE</u>	11

<u>LISTENING TO MUSIC</u>	12
BROWSING YOUR MUSIC LIBRARY	12
SHOW AND HIDE TRACKS	12
PLAYING THE CURRENT TITLE	12
SELECTING A DIFFERENT SONG	13
CHANGING THE GUIDE VIEW	13
View By Artist	13
View By Title	13
View By Song	13
View By Cover	13
CHANGING THE CURRENT PLAY MODE	14
VIEWING BY GENRE	14
<u>LISTENING TO INTERNET RADIO</u>	15
BROWSING INTERNET RADIO STATIONS	15
PLAYING THE CURRENT STATION	15
<u>WATCHING DVD MOVIES</u>	16
BROWSING YOUR MOVIE LIBRARY	16
PLAYING THE CURRENT MOVIE	16
CONTROLLING THE DVD PLAYER	16
CHANGING THE GUIDE VIEW	16
View By Title	17
View By Cover	17
VIEWING BY GENRE	17
<u>GETTING MUSIC INTO FIREBALL</u>	18
RECORDING FROM THE INTERNAL CD	18
RECORDING FROM AN EXTERNAL CHANGER	19
<u>MANAGING YOUR MEDIA</u>	20
CREATING PLAYLISTS	20
CREATING GROUPS	21
ADDING INTERNET RADIO STATIONS	22
UPDATING THE INTERNET RADIO STATIONS LIST	23
EDITING MUSIC INFORMATION	24
Editing Disc Info	24
Editing Movie Info	24
Automatically Lookup Information for This Disc	25
Searching for the Original Cover	26
Tips for Searching for Covers	26
Selecting an Existing Cover	27
Editing Track Names	27
EDITING RADIO INFORMATION	28
EDITING PLAYLISTS	29
EDITING GROUPS	30
DELETING MUSIC	31
DELETING PLAYLISTS	32
DELETING GROUPS	32

Table of Contents

SETTING USER PREFERENCES	33
SELECTING THE CLIENT MODE	33
SETTING THE SCREEN SAVER PREFERENCES	34
<i>Activation Idle Time</i>	34
<i>Mode</i>	34
SETTING YOUR TIME ZONE	34
SETTING YOUR ZIP CODE	35
ENABLING PASSWORD PROTECTION	35
<i>Setting a System Password</i>	35
<i>Removing a System Password</i>	35
CHOOSING YOUR NETWORK CONNECTION	36
<i>Ethernet Settings</i>	36
<i>Dialup Settings</i>	37
SETTING THE FIREBALL SERVER NAME	37
SETTING THE AUDIO ENCODER TYPE	38
SETTING THE DISC INSERT PREFERENCES	38
MANAGING EXTERNAL CHANGERS	39
<i>Automatically Getting Disc Information</i>	39
<i>Getting Disc Information for a Range of Discs</i>	40
<i>Getting Disc Information for All Discs</i>	40
RECORDING FROM EXTERNAL CHANGERS	41
<i>Automatically Recording CDs</i>	41
<i>Recording a Range of CDs</i>	42
<i>Recording All CDs</i>	42
FIREBALL UTILITIES	43
<i>Getting Information about Your FireBall</i>	43
<i>Restarting the System</i>	43
<i>Updating the Software</i>	43
ADDITIONAL INFORMATION	44
TROUBLESHOOTING	44
ESCIENT SUPPORT	44
SPECIFICATIONS	44
<i>System</i>	44
<i>Web Access and Embedded Applications</i>	44
<i>Thin Client/Server Computing</i>	44
<i>PC Companion</i>	44
<i>Wireless Network Support</i>	44
<i>Tethered Network Support</i>	44
<i>Dimensions/Weight</i>	44
<i>Regulatory/ Environmental</i>	44
<i>Standard Package & Accessories</i>	44
<i>Optional Accessories</i>	44

THANK YOU

The team at Escient would like to take this opportunity to thank you for purchasing an Escient product. Escient is committed to providing our customers the most technologically advanced, yet easier-than-ever to use products that converge the power of the Internet with home entertainment.

To maximize your enjoyment, please take a few minutes to review this User's Manual. It will guide you through all the features and benefits of your new EWP-2000 V2.

If you should need assistance please call our Customer Support Staff at 800.372.4368

The Escient Team

PRODUCT INTRODUCTION

Thank you for purchasing the FireBall EWP-2000 V2, the two-way wireless web tablet from Escient. The EWP-2000 V2 is a wireless remote control touch screen that provides two way interactive control of any FireBall product that supports the **FireBall Web Interface**. The EWP-2000 V2 allows the user to control a FireBall without using the handheld remote control or TV display. Almost all of FireBall's features are accessible directly from the EWP-2000 V2's high resolution touch screen interface.

ABOUT THIS MANUAL

This FireBall EWP-2000 V2 User Manual is intended to provide the reader with an overview of the main features and benefits of the Escient FireBall EWP-2000 V2 web pad as a wireless remote control device for a FireBall Media Management Server. For more information about the FireBall product line, please refer to the Escient FireBall User's Manuals available on the Escient web site (www.escient.com) or contact your Escient dealer.

RECORD YOUR SERIAL NUMBER

The serial number for this unit is located at the rear of the device. Please record the serial number in the space provided below. Refer to it whenever you call upon your Escient dealer regarding this product.

FireBall EWP-2000 V2 Serial Number: _____

MANUAL DISCLAIMERS

At the time of printing, the FireBall EWP-2000 V2 screen shot images in this manual matched the FireBall EWP-2000 V2 interface screens. However, since FireBall Media Managers and the EWP-2000 V2 have the capability to install software updates and enhancements on a regular basis, the resulting screen updates may no longer match the images in this manual. Check the Escient website for more information on software updates.

REGULATORY NOTICES

This device complies with Part 15 of the FCC Rules. Operation is subject to the following two conditions: (1) this device may not cause harmful interference, and (2) this device must accept any interference received, including interference that may cause undesired operation. To identify this device, refer to the part, series, or model number on the product.

FCC Class B Radio Frequency Interference Statement

This equipment has been tested and found to comply with the limits for a Class B digital device, pursuant to part 15 of FCC Rules. These limits are designed to provide reasonable protection against harmful interference in a residential installation. This equipment generates, uses, and can radiate radio frequency energy and, if not installed and used in accordance with the instructions, may cause harmful interference with radio communications. However, there is no guarantee that interference will not occur in a particular installation.

If this equipment does cause harmful interference to radio or television reception, which can be determined by turning the equipment off and on, the user is encouraged to try to correct the interference as follows:

- Reorient or relocate the receiving antenna.
- Increase the separation between the equipment and receiver.
- Plug the equipment into an outlet on a circuit different from the one connected to the receiver.
- Consult the dealer or an experienced radio or television technician.

CE (EU) Declaration of Conformity

This product conforms to the essential protection requirements of the European Council Directive 89/336/EEC that relates to electromagnetic compatibility, EN55022:1998, Class B; and EN61000-3-2, 3-3, 4-2, 4-3, 4-4, 4-5, 4-6, 4-8, and 4-11.

Modifications

The FCC requires the user to be notified that any changes or modifications made to this device that are not expressly approved by Escient can invalidate FCC approval.



WARNINGS AND PRECAUTIONS

CAUTION: FAILURE TO COMPLY MAY RESULT IN SERIOUS INJURY

Please review the following material carefully. Failure to follow the instructions, or failure to heed the warnings contained herein could lead to serious injury.

Special Battery Cautions

The following are special precautions you should take when using and handling batteries.

- Do not expose batteries to direct sunlight or extreme heat
- Do not submerge batteries in liquid
- Do not incinerate batteries
- Do not handle damaged or leaking battery packs
- Do not attempt to discharge batteries by short-circuiting them
- Do not attempt to charge batteries with a charger other than one approved for use with EWP-2000 V2
- Do not leave or operate the EWP-2000 V2 or EWP-2000 V2 batteries in an excessively hot environment such as a closed vehicle under hot sunshine or beside a fire, heater, or blow dryer. Do not leave EWP-2000 V2 exposed to excessive heat for any period of time. Excessive heat exposure may result in melting, or cause the electronics/battery to overheat resulting in fire.
- Use only the supplied batteries and AC Adapter. Failure to follow this instruction may result in battery burst or liquid leak, and may cause fire, or injury.
- Store and Dispose of all batteries in accordance with the instructions contained herein. Never dispose of the battery by burning. Any such action may result in excessive heating, explosion, or fire.
- Do not disassemble, modify, puncture, or strike any battery with force or allow batteries to become wet. Any such action may result in excessive heat, explosion, or ignition.
- If at anytime the EWP-2000 V2 batteries should smell, heat up, become discolored, leak fluid, change shape, or experience an abnormal occurrence, remove the battery from the EWP-2000 V2 and do not use it.
- Should leaking fluid from the battery make contact with skin, eyes or clothes, flush immediately with water. If there is contact with eyes, seek medical treatment immediately. Failure to follow these instructions may result in skin rash or significant eye damage.

Danger of explosion if battery is incorrectly replaced.

Replace only with the same type recommended by the manufacturer. Dispose of used batteries according to the manufacturer's instructions.

Rechargeable Lithium-ion battery disposal

Unwanted lithium ion battery packs may be returned to the battery manufacturer for disposal.

EWP-2000 V2 Case

Dismantling or opening the case will void warranty and may possibly cause electric shock. Avoid wet environments

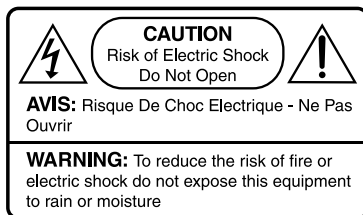

CARING FOR THE EWP-2000 V2

It is important to properly care for your EWP-2000 V2 wireless panel. Follow these guidelines to ensure your device is preserved and protected.

- Avoid scratching the screen by always using the supplied stylus or a plastic-tipped pen intended for use with touch sensitive screens.
- Do not expose EWP-2000 V2 to rain, liquids or moisture for an extended period of time.
- Do not expose EWP-2000 V2 to temperature extremes.
- Do not place any objects on top of the EWP-2000 V2 to prevent screen damage.
- Clean EWP-2000 V2's screen with a soft cloth moistened only with water.

Guidelines for Travel

- Avoid exposing your EWP-2000 V2 wireless panel to magnetic detectors and security magnetic wands. X-ray screening devices should not harm the EWP-2000 V2.
- Place the EWP-2000 V2 in a protective case and take it with your carry-on luggage if traveling by airplane.
- Make sure to disconnect all peripheral devices.
- As the device may still emit radio waves even when you are working offline, do not use the EWP-2000 V2 while on an airplane.

Operating Temperatures and Environments

- Operating Temperature: 0-40 degrees Celsius
- Humidity: 0-90%

CAUTION: Loss of Product Warranty Warning.

Removing back cover can void product warranty. Do not attempt to remove the back cover of your EWP-2000 V2; contact Escient for service assistance.

TRADEMARKS & SERVICE MARKS

Escient®, the Escient logo, and FireBall® are trademarks of Digital Networks North America.

FireBall EWP-2000 V2 and Physital are trademarks of Escient®.

Other product names mentioned herein are used for identification purposes only and may be trademarks of their respective companies.

WARRANTY INFORMATION

Terms of Coverage - Each Escient branded media management system sold comes with a standard one (1) year warranty. This warranty provides no-charge coverage under normal product usage, for a period of one year from the date of registration and/or purchase (whichever is earlier). This warranty program provides the following key features and benefits:

- Twelve (12) months service, parts and labor.
- Five (5) day turn around time on all standard in-warranty repairs. No charges to the customer other than in-bound shipping charges which are determined by the shipping method. All return shipments will be via Standard Ground Transportation (approximately 5 business days).
- Twelve (12) months of regular hour telephone support (9AM to 7PM EST), Monday through Friday.
- 24-hour email response from the Escient Support Website.

What is Covered - The goal of this warranty is to cover operational problems that might arise with your product during normal use. This includes failure to start, improper operation, or intermittent failures. As part of the warranty, Escient will pay for all labor and materials used in the repair of the system. Escient reserves the right to use new or factory refurbished parts in the repair of these in-warranty systems. Escient will also pay for the return shipment of the repaired system via standard ground transportation. At Escient's discretion, the Company will repair or replace any system sent in for repair. Upon repair, the product will be new or like-new in condition and will meet all necessary regulatory requirements.

What is Not Covered - Escient products are sold through Escient approved dealers. A number of items must remain intact in order for Escient to verify and validate this warranty. Additionally, there are several conditions which violate Escient's warranty program. These include:

- The product was not purchased through an approved Escient Dealer.
- Any product, on which the serial numbers has been defaced, modified or removed physically or electronically will not be covered by an Escient warranty.
- Escient will not cover under warranty damage to the product as a result of accident, misuse, abuse, neglect, fire, water, lightning, or other acts of God or nature, improper storage, unauthorized modification, or failure to follow instructions.
- Any type of unauthorized repair or modifications made to the system resulting in damage to the product will not be covered under this warranty.
- Damage caused to the product as a result of improper shipping or installation.
- Any problems related to the use of the product which is not a direct problem with the product.
- Damage caused to the product as a result of improper installation to third party peripherals or products, or incorrect connection to peripheral or products.
- Additionally, Escient does not cover the following items under the terms or its warranty programs:
 - Installation or removal charges.
 - Cost of initial technical adjustments (setup costs).
 - Battery replacement.

Escient's sole liability for any defective product is limited to the repair or replacement of the product at our discretion. Escient shall not be liable for damages to other property caused by defects in this product, damages based upon inconvenience, loss of use of the product, loss of time or data, commercial loss or any other damages, whether real, incidental or consequential.

How to Return a Product - Contact your dealer or Escient's Customer Support group at 800-372-4368.

Please have the following information ready for your dealer or Escient's Customer Support technician

- Product Serial Number
- Model Number
- Date of Registration or Purchase
- Place of Purchase

Upon reviewing the request for repair under warranty provisions, Escient's Technical Support group will issue a Return Material Authorization (RMA) number. This number is to be attached to the outside of the shipping carton. Additional instructions will be provided by technical support. Please be sure to use original packing carton and internal packing materials to assure proper shipment of the system. Insurance costs are the responsibility of the customer. Most shippers only provide standard coverage for \$100 in cost so please protect yourself by providing additional insurance for the returned product.

Out of Warranty Repair - Escient provides out of warranty repair service on a cost plus labor basis. Minimum charges will apply. Technical support will provide information on this service at the time of the call.

Product Introduction

ESCIENT PRIVACY POLICY

Escient is committed to providing you with a product that you enjoy and are confident in using, and are committed to providing services in a private and secure environment.

We recognize and respect each individual user's privacy and have created this Privacy Policy to demonstrate our commitment to your privacy.

We want you to be fully informed about the information that we collect, why we collect it, and with whom we share it.

It is our hope that, after reading this notice, you will understand our commitment to privacy and be confident that we will use your information responsibly. By using the Escient FireBall EWP-2000 V2, you are accepting the practices described in this Privacy Policy.

CONTACT INFORMATION

Escient may be contacted by using the following information. Once you have worked with your local Escient dealer, we encourage you to contact us if you are in need of any further assistance.

Escient

6640 Intech Blvd. Suite 250
Indianapolis, Indiana 46278

Phone: 800-372-4368 Press "2" for Sales, or "3" for Support
Fax: 317-616-6790
Internet: www.escient.com
Email: support@escient.com

Hours: Monday - Friday 9:00am - 7pm EST

COPYRIGHT

This manual is copyright ©2004 by Digital Networks North America and Escient. All rights reserved.

TERMS AND DEFINITIONS

Following are terms used throughout this manual.

- **Button** - refers to a graphic item on the display screen.
- **Group** - a collection of similar music titles. Standard genre groups are provided and custom groups can be created by the user.
- **Highlight** - highlighting is used to indicate the user's selection on screen. When the selection moves up, down, left, or right, the highlight moves to the next nearest item. No action is taken (except that more information may be displayed on the screen) until the Select key is pressed.
- **Info Text Area** - the portion of the guide screen used to display information about the highlighted title.
- **Playlist** - a collection of one or more music tracks or songs.
- **Title** - a collection of music tracks commonly referred to as a CD, Album or Playlist.
- **Key** - refers to one of the buttons on your remote or keyboard.
- **MP3** - a compressed digital audio format. MP3 files are smaller than the original CD tracks and sound almost identical.
- **FLAC** - a lossless compressed digital audio format. FLAC files are smaller than the original CD tracks and are bit for bit duplicates of the original.
- **Guide** - a grid or list of information, used to browse your media library.
- **Player** - the screen used to display the currently playing media.

Setting Up The Web Pad

SETTING UP THE WEB PAD

Thank you for purchasing the Escient EWP-2000 V2 web pad. The EWP-2000 V2 is a specially designed two-way wireless touch screen control device for your FireBall Media Manager.

REQUIREMENTS

- FireBall Media Manager with built-in web server is required for using the EWP-2000 V2.
- 80211b WiFi wireless home network.
- FireBall Media Manager connected to the same home network.
- Internet connection required for Internet Web Browsing and FireBall's disc lookup and update features.

PACKAGE CONTENTS

- Escient EWP-2000 V2 with internal battery and stylus
- AC/DC power adapter (NEVER USE ANY OTHER ADAPTER!)
- Desktop cradle with DC-in power jack
- Power cord
- Internal wireless LAN adapter with adjustable antenna

UNPACKING THE EWP-2000 V2

Unpack the contents of the EWP-2000 V2 box, and make sure that all of the above components are included. If any item is missing or damaged, please contact Escient or your Escient dealer at once.



ADMINISTRATOR ACCOUNT PASSWORD

The EWP-2000 V2 administrator account password is **Admin**. The web pad is configured to auto log on to the administrator account so the password is not generally required but is provided here in case it is ever needed.

Setting Up The Web Pad

POWERING STATES

Powering On the EWP-2000 V2 from "Power Off" Mode

The battery shipped with your EWP-2000 V2 may be low in power – please be prepared to use the AC-DC adapter while setting up the device for the first time and to fully charge the internal battery pack.

The EWP-2000 V2 is delivered from the factory in a "Power Off" or "Reset State".

To start the EWP-2000 V2 for the first time, push and release the Power button located on the left side of the device with the AC-DC adapter connected. The display will come on in about 10 seconds. It will then take 50-60 seconds for the Windows desktop to be displayed.

Powering Off the EWP-2000 V2 to "Standby" Mode

To turn the display off, push and release the power button on the left side.

Powering On the EWP-2000 V2 from "Standby" Mode

If for some reason the EWP-2000 V2 becomes unresponsive, press and hold the power button on the left side of the display for 4 seconds. The display will go out and the EWP-2000 V2 will reboot itself.

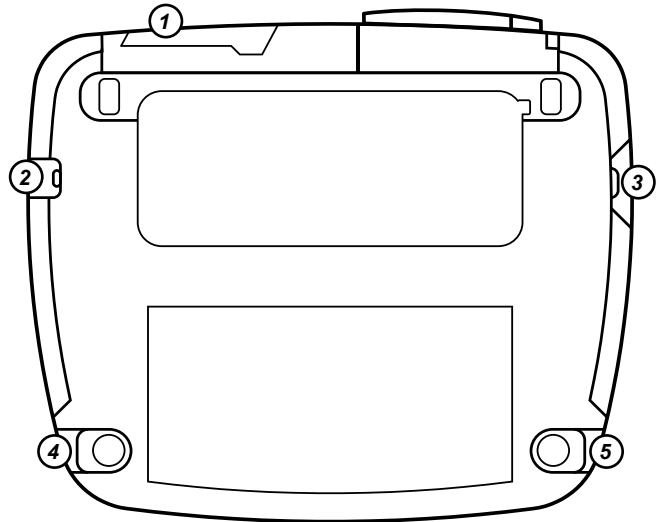

REAR PANEL OVERVIEW

- 1 - Compact Flash Card Reader
- 2 - Headphone jack
- 3 - Power On/Off
- 4 - AC Power In
- 5 - USB jack

USING THE DOCKING CRADLE

The EWP-2000 V2 is complemented by a desktop Cradle for support and pass-through charging. On the cradle, you will find a power jack for the AC-DC power adapter. Please seat the EWP-2000 V2 securely onto the cradle by placing the web pad directly over the connectors in the top of the cradle and inserting the web pad downward until the bottom of the web pad meets the cradle.

You may charge the battery pack on the EWP-2000 V2 by connecting the AC-DC adapter directly to the DC-in port on the EWP-2000 V2 or through the power in port on the Cradle while the EWP-2000 V2 is docked on the Cradle.

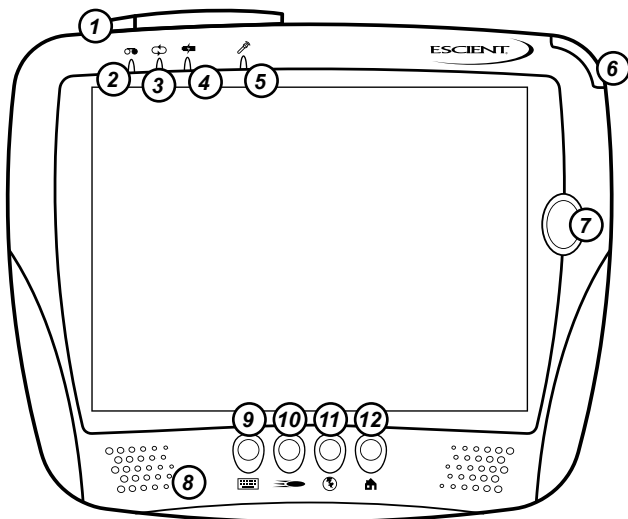

FRONT PANEL OVERVIEW

- | | |
|-----------------|----------------------|
| 1 - Antenna | 7 - Navigation |
| 2 - Record LED | 8 - Speakers |
| 3 - Network LED | 9 - Keyboard button |
| 4 - Battery LED | 10 - FireBall button |
| 5 - Microphone | 11 - Internet button |
| 6 - Stylus | 12 - Home button |

Note: To increase and decrease the brightness of the display, press and hold button "11" and then use button "7" to increase or decrease brightness level.

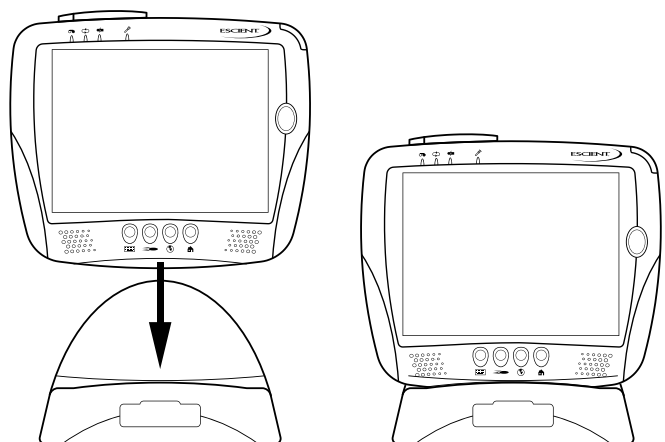

WIRELESS NETWORK CARD AND ANTENNA SYSTEM

The EWP-2000 V2 has a built-in PC Card slot along the upper left edge of the device. This slot contains the wireless LAN adapter and a custom antenna in a snap-type Housing. You can operate the EWP-2000 V2 with the antenna in the snap-on position or in the open position for greater signal strength. To use the antenna in the open position, pull the antenna tip off the retainer snap and try to obtain better wireless connectivity through varying orientations up to near-vertical. Place the antenna in it's down and locked position whenever possible to prevent breakage.

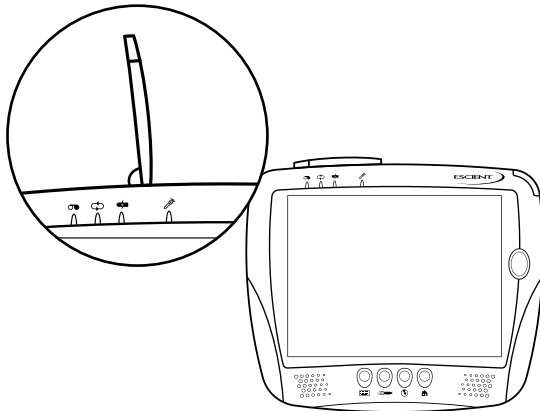

USING THE WEB INTERFACE

The FireBall Web Interface fills the entire screen of the web pad and displays the familiar FireBall user interface. This is the same interface that appears on your PC web browser when you connect to your FireBall using the built in web server. The only difference is that a special web browser is used on the web pad which allows the full 800x600 screen to display the web interface.

To operate the web interface, hold the web pad in one hand or leave it docked in the docking cradle, remove the stylus from the top right of the web pad and select any of the buttons or controls which appear on screen. More details are provided in the following sections of this manual.



ENTERING TEXT WITH THE ON SCREEN KEYBOARD

Pressing the left most button on the EWP-2000 V2 web pad will show and hide the Windows XPe popup keyboard. When the keyboard is displayed, tap on any character to enter text into the active area on the screen. Press the button again to hide the keyboard.

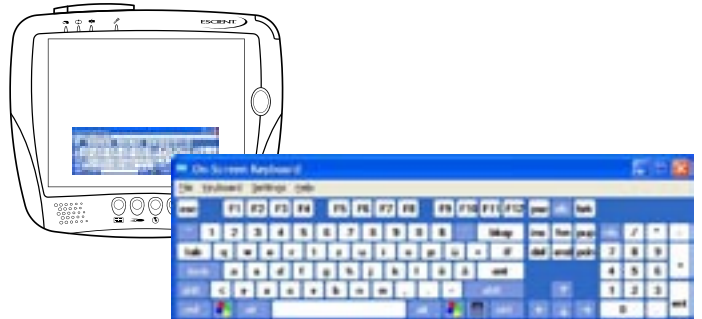

WINDOWS SYSTEM KEY COMBINATIONS

- F1:** Help
- CTRL+ESC:** Open Start men
- ALT+TAB:** Switch between open programs
- ALT+F4:** Quit program
- F11:** Internet Explorer full screen toggle

CALIBRATING THE SCREEN

The touch display for the EWP-2000 V2 is calibrated before shipping. In the event that the calibration has been modified or is unsatisfactory, you may use the PenMount (PM) utility, accessible from the System Tray on the lower right portion of the display, to calibrate the touch interface. You may activate this application with touch input via Stylus or mouse click via a USB mouse. This PenMount utility also offers the Right Mouse Button function.

ADJUSTING THE BACKLIGHT LEVEL

You can adjust the EWP-2000's LCD touchscreen backlight level by using the 4-way navigation (#7) pad while holding down the Internet button (#11).

- Up: Brighter** - will show the brightness indicator bar and adjusts the brightness to 1 tick brighter.
- Down: Darker** - will show the brightness indicator bar and adjusts the brightness to 1 tick darker.
- Left: Darkest** - will show the brightness indicator bar and adjusts the brightness to the lowest setting – effectively blacking it out.
- Right: Brightest** - will show the brightness indicator bar and adjust the brightness to the highest setting.

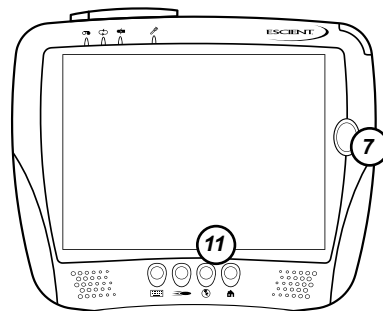

Setting Up The Web Pad

CONNECTING TO YOUR WIRELESS NETWORK

Note: The EWP-2000 V2 connects and controls your FireBall server by using your existing wireless network. Any standard 802.11b WiFi network can be used. The setup and configuration of a wireless network is beyond the scope of this document and it is assumed that your network is properly configured. If you require assistance in configuring and setting up a wireless network, please contact your Escient dealer.

The Windows XPe zero configuration tool should automatically run the first time you turn on the EWP-2000 V2. You can also run the connection tool manually at any time. Follow these steps to connect the EWP-2000 V2 to your existing wireless network.

1. Select the HOME button on the front panel of the EWP-2000 V2 to display the Windows XP3 Desktop.
2. Select Wireless LAN icon located on the System Tray to display the Wireless Network Connection Status dialog.
3. Select the Properties button to display the Wireless Network Properties screen.
4. Select the Wireless Networks tab.
5. Select the Refresh button to update the list of available wireless access points which are within range of your web pad.
6. Select the name of your wireless access point (which should appear in the list of Available Networks that are in range) and then select the Configure button to display the Wireless network properties dialog.
7. Enter the SSID of the network.
8. If your wireless network uses any kind of security (we suggest that you do use security), select the proper authentication and encryption type, and enter the Network key. Please refer to the documentation that came with your wireless access point for more information about setting up a secure wireless network.
9. Select the OK button to save your settings on the Wireless network properties dialog.
10. Select the OK button to save your settings on the Wireless Network Connection Properties dialog.
11. The Wireless Network Connection Status dialog should now be displayed and indicate that you are connected to the selected wireless network. If the status is not Connected, please make sure you are within range of your wireless access point and repeat these steps.
12. Select the CLOSE button to close the Wireless Network Connection Status dialog.

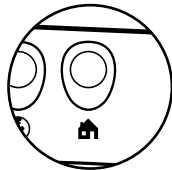

Connecting To Your FireBall

CONNECTING TO YOUR FIREBALL

The FireBall E2 contains a built-in web server capable of serving web pages specifically designed to control almost every aspect of the FireBall from a standard web browser such as Microsoft's Internet Explorer.

SELECTING YOUR FIREBALL SERVER

On the web pad, launch the "FireBall Connect" Application by pressing the FireBall button the front panel of the Web Pad.

NOTE: You can also double-tap the FireBall Connect icon on the Desktop.

A list of the available FireBall servers is displayed. Select the server name you want to connect to and then select the OK button. After a few seconds, the EWP-2000 V2 will configure this server as the default server and load the Music Guide.

MANUALLY CONNECTING TO YOUR FIREBALL

In addition to using the FireBall Connect application, you can manually connect to your FireBall Server from Internet Explorer, if you know the "IP Address" of your FireBall.



Follow these steps to determine the IP Address:

1. Select the SETUP button to display the Setup menu on your TV.
2. Select the Utilities menu item.
3. Select the System Information menu item.
4. Write down the IP Address of your FireBall's Ethernet connection. This number is located in the bottom right of the System Information screen and consists of four numbers separated by periods. Example: 192.168.1.1
5. Select the SETUP key again to exit Setup

Using your web pad's Internet Explorer web browser (or any web browser connected to the same network as your FireBall) enter the IP address of your FireBall and then the RETURN command. Your FireBall Server's Music Guide will appear in the web browser in a few seconds.

FIREBALL WEB INTERFACE

The FireBall Web Interface is the graphics and control system web pages that appear in your Internet Explorer browser. From this web page, you can control almost every aspect of your FireBall, just as you would from the original IR remote and TV. The familiar FireBall Guide, Player, Options and Setup mode are all supported from the Web Interface.

You will notice that unlike the TV user interface, there are buttons along the left and right edges of the web browser. These buttons duplicate the features found on your remote control.

MUSIC GUIDE SCREEN



MUSIC PLAYER SCREEN



MUSIC OPTIONS SCREEN



LISTENING TO MUSIC

BROWSING YOUR MUSIC LIBRARY

The **Music Guide** allows you to browse, locate, and play all of your music in one easy to use on-screen guide.

The **Music Guide** displays a list of all your Music Titles. Using the Page buttons on the right edge of the screen, you can scroll up and down the list.

SHOW AND HIDE TRACKS

If you select a Title in the list, you will expand the current Title to reveal a list of the Title's **Tracks**.

Select the Title again to collapse the current Title and hide the track names.

PLAYING THE CURRENT TITLE

Playing the currently highlighted Title is the same as playing a CD in a conventional CD player. Simply **select the PLAY** button and it begins to play from track 1.

Note: If you select a track name, you will start playback from the selected Track.

You'll notice that a new screen appears with a list of the songs (or tracks) on the current Title, this is the **Music Player** screen. The **Music Player** displays the artist name, album name, album cover art, and track list for the current Title.

MUSIC GUIDE SCREEN



MUSIC GUIDE SHOWING TRACKS



MUSIC PLAYER SCREEN



SELECTING A DIFFERENT SONG

In the **Music Player** you can scroll up and down the track list using the page button on the right edge of the screen. Select a different song to play the song.



CHANGING THE GUIDE VIEW

The **PLAYER** button on the left edge of the screen is used to switch between the **Music Guide** and **Music Player** screens. When you are viewing the Music Player screen, select the **GUIDE** button to return to the **Music Guide**.



The Music Guide provides you with several ways to view the contents of your Music Library. One of the easiest ways to browse and sort your Music Library is by using the Music “Views”. There are four Views that you can toggle through using the **MENU/VIEW** button on the left edge of the screen:

- View By Artist
- View By Title
- View By Song
- View By Cover

View By Artist

View By Artist is the default View and displays your Music Library alphabetically from A to Z using according to the Artist Name then the Album Name.



View By Title

View By Title will order the list of Titles alphabetically from A to Z, according to the Album Name then the Artist Name.



View By Song

View By Song will order the list of Titles alphabetically from A to Z, according to the Song Name.



View By Cover

View By Cover displays a graphical 3x3 grid of album cover art, sorted alphabetically from A to Z, according to the Artist Name then Album Name.

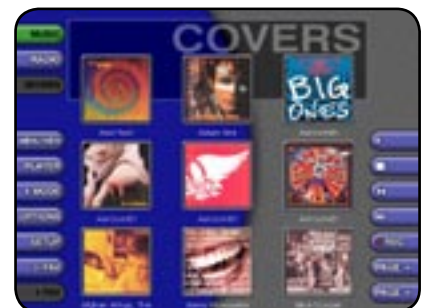

CHANGING THE CURRENT PLAY MODE

The default Play Mode will play the current Title from Track 1 to the last track in order, then stop. If you want to change the order of how tracks are played, there are six different Play Modes to choose from:

- Normal – play each track in order in the current Title, then stop.
- Repeat Track – repeat the same track over and over until you select stop.
- Repeat Title – play each track in the current Title in order then repeat the entire disc until you select stop.
- Repeat Group – play each track in each title in the current group and then repeat them until you select stop.
- Random Title –randomly select and play a track from within the current title. Continue until you select stop or every track in the current title is played.
- Random Group – randomly select and play a track from any title in the current group. Continue until you select stop or every track in the current group is played

To change the current Play Mode, select the **PLAY MODE** key on the left edge of the screen. Each press of the **PLAY MODE** key will switch to the next Play Mode. Stop pressing the **PLAY MODE** key when you see the desired Play Mode appear on the screen.

VIEWING BY GENRE

In addition to the current Guide View, the **Music Guide** automatically organizes your Music into default “Genres” also called “Groups”. The Group Bar displays a horizontal scrolling list of Genres corresponding to the music in your library. Five Genres or Groups are visible at one time. The “All” genre is the default, which displays all Titles in your Music Library.

LEFT and RIGHT arrow buttons appear on the left and right edges of the Group Bar when more Groups are available. Pressing these arrows scrolls the Group Bar horizontally by one or 5 items at a time. Notice that the list of Titles updates to show only Titles in the selected Genre.

- Scroll all the way to the left to return to the All Genre.
- Genre list will scroll to the right to reveal more Genres.
- Refer to the section “Managing Your Media” for instructions on creating your own Genres to create custom groupings of your favorite music titles



LISTENING TO INTERNET RADIO

BROWSING INTERNET RADIO STATIONS

The **Radio Guide** displays a scrolling list of Internet Radio Stations. Using the Page buttons on the right edge of the screen, you can scroll up and down the list. As each Station is highlighted, you will notice that the Information Area and Cover Art changes to reflect the currently highlighted Station.

PLAYING THE CURRENT STATION

Simply **select the PLAY** key on the right edge of the screen and the currently highlighted station will be located, buffered, and then played.

You'll notice that a new screen appears displaying information about the selected station. This is the **Radio Player** screen. The **Radio Player** displays the station name, location, genre, genre cover art, and status about the current Internet Radio station stream. FireBall will attempt to locate the station to make sure it is currently broadcasting over the Internet, connect to it, buffer some audio, then begin playing the audio stream. The status of all of this activity is indicated at the bottom left of the screen.

- Playing Internet Radio requires a valid Internet connection.
- Although some stations will work over a Dialup Internet Connection, a broadband Internet connection is recommended.
- Due to the dynamic nature of the Internet, you may experience periodic audio drop-outs which could be due to many factors such as Internet access problems, busy networks, etc...
- Internet Radio Stations are not hosted by Escient and may not be available at all times. You can update your Internet Radio Stations list by running Tune Stations. Please refer to the "Managing Your Media" section for more information.



WATCHING DVD MOVIES

The Movies source button is only available when you are connected to an Escient DVDM Media Manger with an external DVD changer. The Movies source button will be disabled when you are connected to a FireBall Music Manager.

Please refer to the FireBall DVDM User's Guide for information about setting up external DVD changers and loading your DVD movies.

BROWSING YOUR MOVIE LIBRARY

Once you have properly configured your DVDM, loaded your DVDs into the external changer, and the Quick Lookup feature has acquired information for your DVD collection, the Movies Guide allows you to browse, locate, and play all of your DVD movies in one easy to use on-screen guide.

The Movies Guide displays a list of all your Movies Titles. Using the Page buttons on the right edge of the screen, you can scroll up and down the list.

PLAYING THE CURRENT MOVIE

Playing the currently highlighted Movie is the same as playing a DVD in a conventional DVD player. Simply select the PLAY button. The appropriate DVD disc is located in your external changer, loaded into the player and begins to play.

You'll notice that a new screen appears with a description of the movie, a large cover image, and DVD controls. This is the Movies Player screen. The Movies Player displays information about the current movie and lets you control the playback of the DVD player using the touch screen.

CONTROLLING THE DVD PLAYER

In the Movies Player you can access the DVD's menu system by using the DVD Top Menu and the DVD Menu buttons. Use the arrow buttons to navigate up, down, left, and right within the DVD's on screen menu.

CHANGING THE GUIDE VIEW

The GUIDE button on the left edge of the screen is used to switch between the Movies Guide and Movies Player screens. When you are viewing the Movies Player screen, select the GUIDE button to return to the Movies Guide.



MOVIES GUIDE SCREEN



Watching DVD Movies

The Movies Guide provides you with several ways to view the contents of your DVD Library. One of the easiest ways to browse and sort your Movies Library is by using the Movies "Views". There are two Views that you can toggle through using the "MENU/VIEW" button on the left edge of the screen:

- View By Title
- View By Cover

View By Title

View By Title will order the list of Movies alphabetically from A to Z, according to the movie's title.

View By Cover

View By Cover displays a graphical 3x3 grid of movie cover art, sorted alphabetically from A to Z, according to the movie's title.

VIEWING BY GENRE



In addition to the current Guide View, the Movies Guide automatically organizes your Movies into default "Genres" also called "Groups". The Group Bar displays a horizontal scrolling list of Genres corresponding to the Movies in your library. Five Genres or Groups are visible at one time. The "All" genre is the default, which displays all DVDs in your Movie Library.



LEFT and RIGHT arrow buttons appear on the left and right edges of the Group Bar when more Groups are available. Selecting these arrows scrolls the Group Bar horizontally by one or 5 items at a time. Notice that the list of Titles updates to show only Titles in the selected Genre.

- Scroll all the way to the left to return to the All Genre.
- Genre list will scroll to the right to reveal more Genres.
- Refer to the section "Managing Your Media" for instructions on creating your own Genres to create custom groupings of your favorite Movies titles



Getting Music Into FireBall

GETTING MUSIC INTO FIREBALL

Before you can enjoy the many benefits of your FireBall Music Management system, you will want to get your music collection into the FireBall. The process of getting music into FireBall is called “Recording” or sometimes “Ripping”.

There are several ways to get your music into FireBall:

- Record CDs using the internal CD Drive
- Record CDs using optional external CD changers
- Record from an external source (such as a tape, LP, or other real-time source)
- Transfer Music files from your PC using a network

You may choose to use any or all of these methods at any time. Here is a brief description of a few of these methods, however you should refer to the FireBall User’s Manual for more detailed information about getting music into your FireBall.

RECORDING FROM THE INTERNAL CD

The easiest and quickest way to get music into your FireBall is to record CDs using the built-in internal CD drive. This method requires no additional equipment and is very fast, as the internal CD drive can rip audio at several times the speed of normal playback. This is known as “fast-ripping”.

Follow these steps to record using the internal CD drive:

1. Select the EJECT key on the front panel of your FireBall.
2. Insert an audio CD (label side up) into the CD tray.
3. Select the EJECT key again to close the CD tray.
4. The CD cover and track names for this CD will appear on your web pad. (If the disc is not in the FireBall’s local database, FireBall will use your Internet connection to retrieve the disc information).
5. Select the RECORD button on the right side of the web pad’s screen to display the Recording Options Menu.
6. Make sure that rip to internal hd is selected, then select the CONTINUE button.
7. The Record Select Guide will be displayed showing the current CD with checkmarks to the left of each track name.
8. Select the CONTINUE button to begin recording.

- When recording is complete, FireBall will return to the Music Guide.
- Repeat steps 1-8 for each disc in your music collection.
- Refer to the section “Setting User Preferences” for setting Recording Preferences and Disc Insert Preferences.



Getting Music Into FireBall

RECORDING FROM AN EXTERNAL CHANGER

FireBall can manage up to three - 400 disc CD changers in addition to any music recorded onto the internal hard drive.

Recording from an external changer (of course) requires at least one supported external CD changer properly connected to FireBall. Recording from an external changer is much slower than recording from the internal CD drive because each CD must be played and recorded in real-time compared to the fast ripping speed of recording from the internal CD drive.

All changer based CDs are seamlessly integrated into the same easy to use Music Guide as your recorded CDs.

Please refer to the FireBall's User Manual for details on how to setup and record from an external changer, as well as the additional method of getting music into your FireBall.

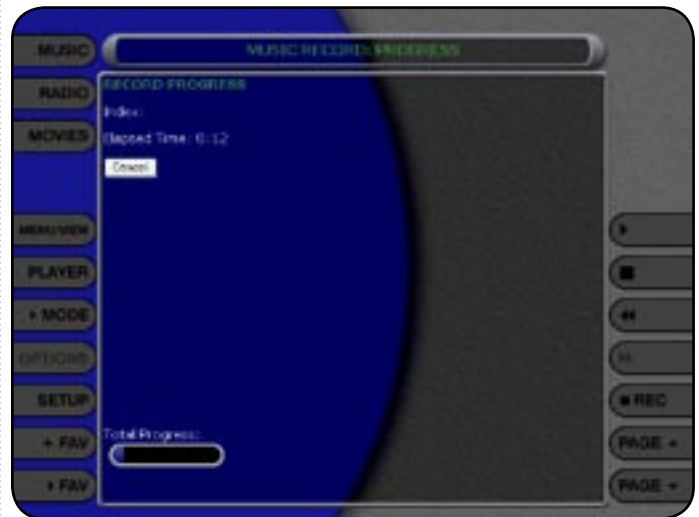
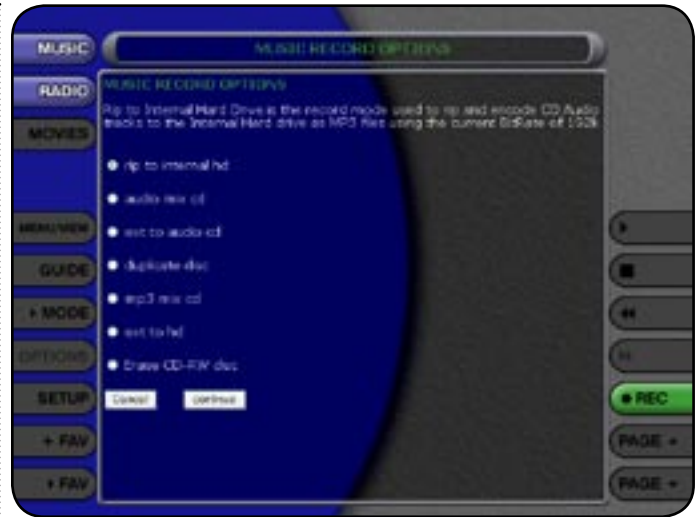

MANAGING YOUR MEDIA

CREATING PLAYLISTS

FireBall allows you to organize your favorite songs into custom “Playlists”. A Playlist is simply a group of songs that you choose from your Music Library. Common uses for Playlists are:

- Collections of your favorite songs
- Songs that have a similar tempo or feel
- Custom albums from one or more of your favorite artists
- Party mixes
- Workout mixes

Playlists are available only in the Music Source. Follow these steps to create your own custom Playlist:

1. Select the **MUSIC** source button to make sure you are in the Music source.
2. Select the **OPTIONS** button to display the Options Menu.
3. Select the **New Playlist** menu item.
4. Using the popup keyboard, enter a name for your Playlist.
5. Select the **CONTINUE** button on screen to advance to the Edit Playlist Select Guide. The Edit Playlist Select Guide works just like the Music Guide. Page up and down the list and select the **OPEN** or **CLOSE** button, expand, or collapse music titles.
6. For each song you want to add to the Playlist, select the box to the left of the song. A checkmark appears in the box of each selected song indicating that it will be added to the Playlist. Select the box again to remove the checkmark.
7. When you have selected all of the songs you want to include in the playlist, select the **SAVE** button on the New Playlist screen to save the Playlist.

- The new Playlist is added to the Playlist Group on the Group Bar.
- You can play any Playlist the same way you play a music title or CD. Just select the Playlist you want to play and then select the **PLAY** button.
- Notice that a Playlist genre is added to the Group Bar. The Playlist genre will always be available as long as you have at least one playlist in your Music Library.

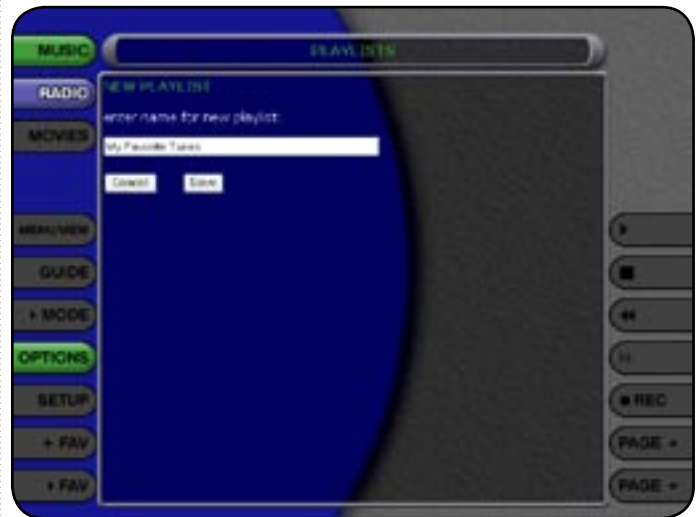
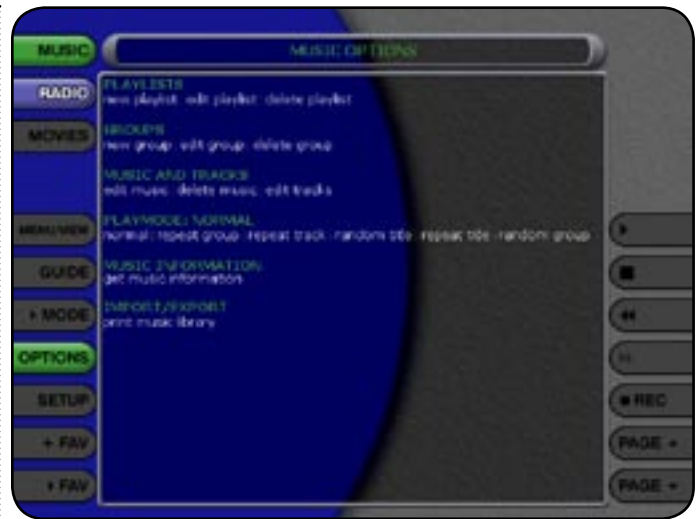

CREATING GROUPS

In addition to Playlists, FireBall allows you to create custom “Groups” of Music Titles, DVD Movies, or Radio Stations. User created Groups appear in the Group Bar along with the automatically created Genre Groups and System Groups (All, CDs, Internal, and Playlists). Some uses for custom Group are:

- Organize music titles or radio stations into custom genres, like “Funk”, 80’s, “Hits”, etc...
- Group all of the albums for a favorite artists together for quick access.
- Create an easily accessible collection of your favorite albums.

To create a custom Group, follow these steps:

1. Select the **MUSIC** source button to make sure you are in the Music source mode or select the **RADIO** source button if you want to create a custom Radio Group.
 2. Select the **OPTIONS** button to display the Options Menu.
 3. Select the **New Group** menu item.
 4. Using the popup keyboard, enter a name for your Group.
 5. Select the **CONTINUE** button on screen to advance to the Edit Group Select Guide. The Edit Group Select Guide works just like the Music or Radio Guide.
 6. For each Music Title or Radio Station you want to add to the Group, select the box to the left of the Title. A checkmark appears on the box of each selected Title or Station indicating that it will be added to the Group. Select the box again to remove the checkmark.
 7. When you have selected all of the Titles or Stations you want to include in the group, select the **SAVE** button on the New Group screen to save the Group.
- Notice that a custom Group is added to the Group Bar along with the System Groups.
 - The custom Group will always be sorted alphabetically within the Group Bar and appear to the right of the All and Playlist Groups.

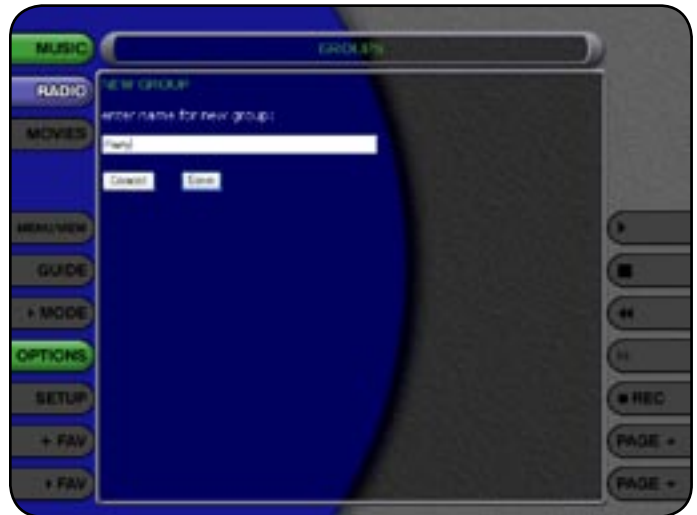

ADDING INTERNET RADIO STATIONS

FireBall comes preloaded with several high quality streaming Internet Radio Stations from around the world, but that may not be enough for you, so FireBall also let's you add your own Internet Radio Stations.

Internet Radio stations must conform to these specifications:

- Windows Media WMA streams only. (MPEG, RealAudio, and other's won't work)
- Windows Media 8 or earlier. Windows Media 9 is not supported.

To add your own Internet Radio Stations, you will need to obtain the URL or Internet Link to the stream using your PC and Microsoft's Windows Media Player. Please refer to the Microsoft web site for information on WMA and Windows Media Player.

Assuming you have a valid URL for a station, follow these steps to add your own Internet Radio Station to the Radio Guide:

1. Make sure you are in the Radio source mode by selecting the RADIO source mode on the left edge of the screen.
 2. Select the OPTIONS button to display the Options Menu.
 3. Select the New Station menu item.
 4. Using the popup keyboard, enter information for the new station including: station name, location, URL, the bit rate of the stream, the genre, and the number of channels (mono or stereo). The cover art will be set according to which genre you select.
 5. Select the SAVE button to save the new station.
- When you are finished creating your new station, the Radio Guide is displayed with the newly created Station.
 - You can play the station just like any other Internet Radio station.

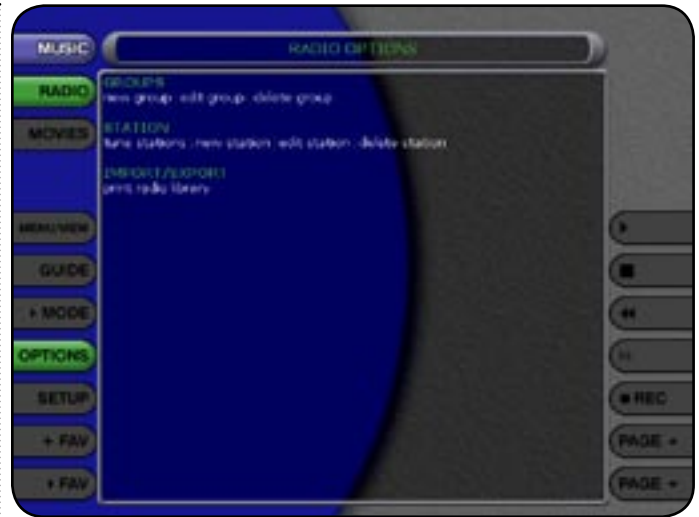

UPDATING THE INTERNET RADIO STATIONS LIST

Escient makes every attempt to insure that the preloaded Internet Radio Stations are alive and well, but due to the dynamic nature of the Internet and the third parties who actually serve up these radio streams, sometimes you will not be able to play a station. The "Tune Stations" feature allows you to download a list of the most recent Internet Radio stations from Escient.

Note: Tune Stations WILL NOT erase any custom stations you may have added, from your Radio Guide. It WILL replace the Escient supplied stations with a fresh new list.

If you want to replace the current Internet Radio Stations with a new list of stations, follow these steps:

1. Select the Radio source button to make sure you are in the Radio source.
2. Select the OPTIONS button to display the Options Menu
3. Select the Tune Stations menu item.
4. Read the WARNING screen and select Tune Stations to proceed.
5. FireBall will Connect to the Escient server and download the latest Internet Radio Stations.

When you are finished Tuning the Stations, the Radio Guide is displayed showing only the new Internet Radio Stations and any user added stations.

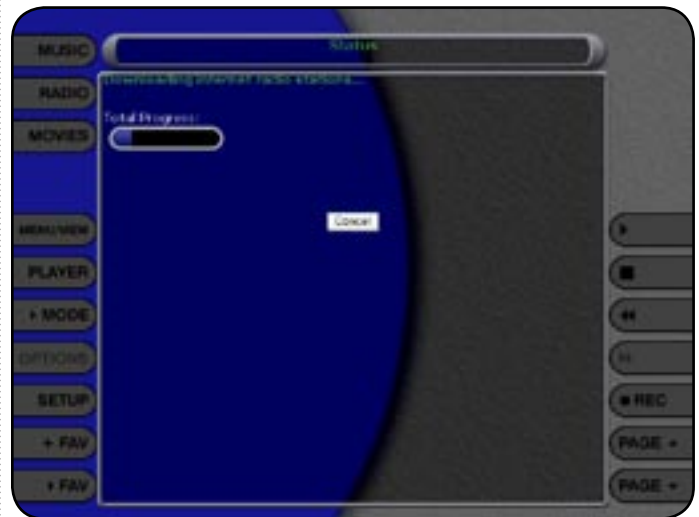
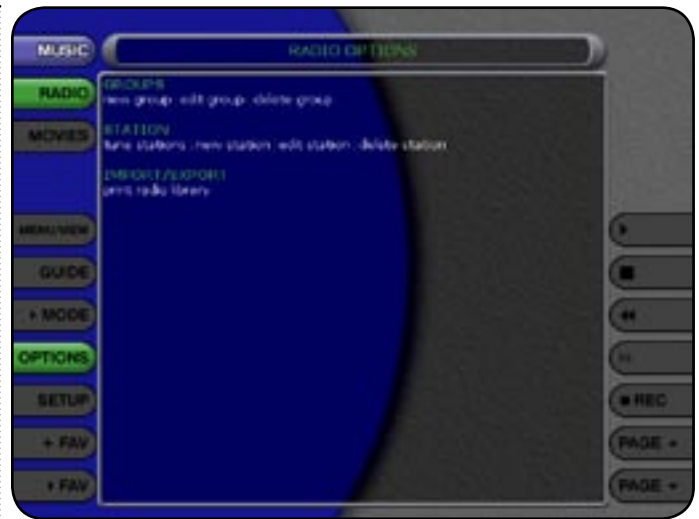

EDITING MUSIC INFORMATION

FireBall has access to over 3 million CD titles, but you may still encounter a CD that does not return a custom cover or the correct disc information. You can edit the disc information for any Music Title using the Edit Disc and Edit Tracks screens.

Editing Disc Info

Follow these steps to edit the disc information for the current Music Title:

1. Select the Music Title you want to edit in the Music Guide.
2. Select the OPTIONS button to display the Options Menu.
3. Select the EDIT MUSIC menu item to display the Edit Music Information screen.
4. Using the popup keyboard, change the artist name, album title, label, year of release, or genre.
5. Select the SAVE button to save your changes and return to the previous screen.

Edit Movie Info

You can also edit DVD movie information for any using the Edit Movie Info screen.

Follow these steps to edit the DVD information for the current DVD Movie:

1. Select the DVD Title you want to edit in the Movies Guide.
2. Select the OPTIONS button to display the Options Menu.
3. Select the EDIT MOVIE menu item to display the Edit Movie Information screen.
4. Using the popup keyboard, change the movie title, studio, year of release, etc...
5. Select the SAVE button to save your changes and return to the previous screen.



Automatically Lookup Information for This Disc

The "Lookup This Disc" button will initiate a disc lookup for only the current title. First, the local database is checked for a match, then if a match is not found, FireBall will connect to the Internet to download the disc information.

Follow these steps to lookup information for the current disc:

1. Select the Music or Movie Title you want to edit in the Music or Movies Guide.
2. Select the OPTIONS button to display the Options Menu.
3. Select the EDIT MUSIC or EDIT MOVIE menu item to display the Edit Information screen.
4. Select the Lookup This Disc button. The Get Info screen will be displayed as FireBall attempts to lookup the disc information for you.
5. When the lookup is complete, you will return to the Edit Disc Information screen where you can verify or edit the results.
6. Select the SAVE button to save your changes and return to the previous screen.



Searching for the Original Cover

Occasionally the wrong cover or the default cover will be displayed for a Music Title. You can manually search for the original cover art by using the “Search for Cover” feature. This is a very powerful tool that allows you to search the Escient servers for an exact or partial match using the artist name and/or album name.

Follow these steps to search for a cover:

1. Select the Music Title you want to edit in the Music Guide.
2. Select the **OPTIONS** button to display the Options Menu.
3. Select the **EDIT MUSIC** menu item to display the Edit Music Information screen.
4. Select the Search for Cover button to display the Search for Cover screen.
5. The current Artist Name and Album Title are entered as the default search strings. You can change either one of these to modify the search. Note that editing the Artist Name or Title **WILL NOT** change them in the Music Library. These edits are **ONLY** used to search for a new cover.
6. Select the **SEARCH** button to start the search.
7. The Get Music Info screen will be displayed as FireBall attempts to search for the cover using the Artist Name and Title you entered.
8. When the search is complete, you will return to the Edit Music Information screen where you can verify or edit the results.
9. Select the **SAVE** button to save your changes and return to the previous screen.

Tips for Searching for Covers

The Escient server uses a fuzzy-match algorithm to locate a matching cover using the Artist Name and Title you enter. There are a few tips to try when searching for covers:

- Remove any punctuation marks from the Artist Name and Title.
- Remove Disc Numbers from the Titles.
- Try different spellings in the Title.
- Try removing part of the Artist Name (if it is more than 2 words).



Selecting an Existing Cover

If for some reason you cannot download the original cover, you can choose one of the existing covers for the current Music Title or DVD Movie

Follow these steps to select an existing cover to assign to the current Title:

1. Select the Title you want to edit in the Guide.
2. Select the OPTIONS button to display the Options Menu.
3. Select the EDIT MUSIC or EDIT MOVIE menu item to display the Edit Information screen.
4. Select the Select a Cover button to display the Select Cover Art screen.
5. Locate the name of the Title corresponding to the cover you wish to use for the current Title in the list of covers. Notice that a preview of the selected cover appears on the right of the list as you highlight each name. Note that it may take several minutes to display all the covers available on your FireBall.
6. Select the SAVE button when you have located the cover of your choice and return to the previous screen.



Editing Track Names

You can also manually edit the Track/Song names of the current Title in the Music Guide.

Follow these steps to edit the track information for the current Music Title:

1. Select the Music Title you want to edit in the Music Guide.
2. Select the OPTIONS button to display the Options Menu.
3. Select the EDIT TRACKS menu item to display the Edit Tracks screen.
4. Using the popup keyboard, change the name of each track.
5. Select the SAVE button to save your changes and return to the previous screen.

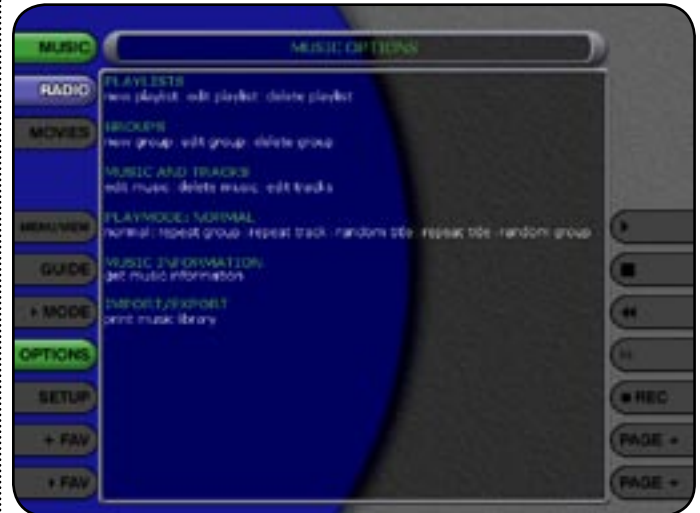

EDITING RADIO INFORMATION

Similar to editing Music Information, you can also Edit the Radio Information.

Follow these steps to edit the station information for the currently highlighted Internet Radio Station:

1. Select the RADIO source button to make sure you are in the Radio source.
2. Select the OPTIONS button to display the Options Menu.
3. Select the Edit Station menu item to display the Edit Station screen.
4. Using the popup keyboard, edit the information for the new station including: station name, location, URL, the bit rate of the stream, the genre, and the number of channels (mono or stereo). The cover art will be set according to which genre you select.
5. Select the SAVE button to save the changes.

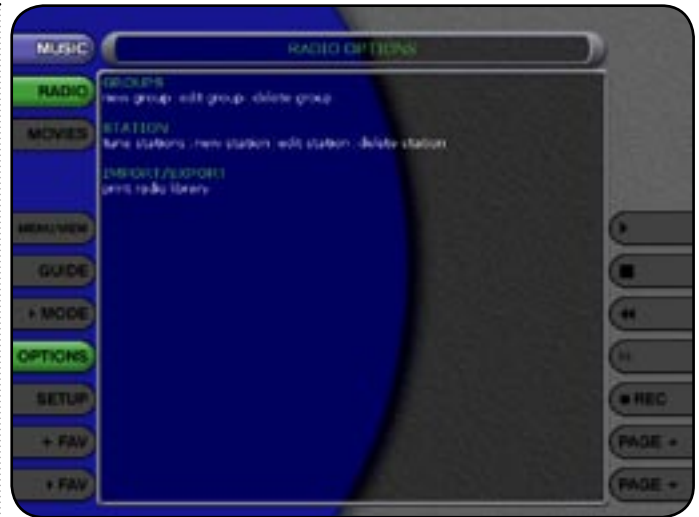

EDITING PLAYLISTS

You can change the name and add or remove tracks from any Playlist you created.

Follow these steps to edit a Playlist:

1. Select the **MUSIC** source button to make sure you are in the Music source.
2. Highlight the Playlist Name you want to edit. Note: The Playlist group will list all of your Playlists.
3. Select the **OPTIONS** key to display the Options Menu.
4. Select the Edit Playlist menu item.
5. Using the popup keyboard, change the name of your Playlist or select the **CONTINUE** button on screen to keep the current name and advance to the Edit Playlist Select Guide.
6. For each song you want to add to the Playlist, select the box to the left of the song. A checkmark appears in the box indicating that it will be added to the Playlist.
7. For each song you want to remove from the Playlist, select the box again and the checkmark will be removed, indicating that the song should be removed from the Playlist.
8. When you have added or removed all of the songs you want to include in the playlist, select the **SAVE** button to save the Playlist.

- If you remove all songs from a Playlist, the Playlist is automatically deleted.
- You cannot reorder songs within a current Playlist.



EDITING GROUPS

As with Playlists, you can also edit the name of a Group, add Music Titles or Radio Stations to the Group, or remove Music Titles or Radio Stations from the Group.

Follow these steps to edit a Group:

1. Select the Group you want to edit within the Group Bar.
2. Select the OPTIONS button to display the Options Menu.
3. Select the Edit Group menu item.
4. Using the popup keyboard, change the name for your Group.
5. Select the CONTINUE button on screen to advance to the Edit Group Select Guide.
6. For each item you want to add to the Group, select the white box to the left of the Title. A checkmark appears on the box of each selected Title or Station indicating that it will be added to the Group. Select the box again to remove the checkmark.
7. When you have selected all of the Titles or Stations you want to include in the group, select the SAVE button on the New Group screen to save the Group.

- You cannot edit the System Groups (All, CDs, Internal, or Playlists).
- If you remove all Titles or Stations from a Group, the Group is automatically deleted.
- You cannot reorder Titles and Stations within a Group. They are always sorted alphabetically.



DELETING MUSIC

You can remove any music you have recorded to the FireBall by using the Delete Music feature. You may want to do this if you have filled up your FireBall and you cannot record any more music or if you want to remove songs that you just don't listen to.

Follow these steps to delete music from your FireBall:

1. Select the **MUSIC** key to make sure you are in the Music source mode.
2. Select the **OPTIONS** key to display the Options Menu
3. Select the Delete Music menu item to display the Delete Music screen.
4. For each Track you want to delete, highlight the Track and select the **SELECT** key on the remote. A checkmark appears to the right of each selected Track indicating that it will be deleted. Select the **SELECT** key again to remove the checkmark. Selecting the **Toggle** key on the remote when a Title is highlighted will toggle all or none of the Title's tracks for deletion.
5. When you have selected all of the Titles you want to delete in the group, select the **RECORD** button on the remote control to permanently remove and delete the checked tracks.

You cannot "delete" physical CDs from the Music Library. You must remove the discs from your changers if you want the CDs to be removed from the Music Guide.



DELETING PLAYLISTS

You may delete entire Playlists from the Music Guide. Follow these steps to permanently delete one or more Playlists from the Music Guide:

Follow these steps to delete playlists from your FireBall:

1. Select the **MUSIC** button to make sure you are in the Music source.
2. Select the **OPTIONS** button to display the Options Menu
3. Select the Delete Playlists menu item to display the Delete Playlists screen.
4. For each Playlist you want to delete, select the box to the left of the playlist name. A checkmark appears in the box indicating that it will be deleted. Select the box again to remove the checkmark.
5. When you have selected all of the Playlists you want to delete, select the **SAVE** button to permanently remove and delete the checked Playlists.



DELETING GROUPS

Deleting Groups from the Group Bar is very similar to deleting Playlists. The contents of the Group (the Music Titles, DVD Movies or Radio Stations) are not deleted. They are still available in any other Groups they may be assigned to and in the All Group.

Follow these steps to delete Groups.

1. Select the **OPTIONS** key to display the Options Menu
2. Select the Delete Groups menu item to display the Delete Groups screen.
3. For each Group you want to delete, select the box to the left of the Group name. A checkmark appears in the box indicating that it will be deleted. Select the box again to remove the checkmark.
4. When you have selected all of the Groups you want to delete, select the **SAVE** button to permanently remove and delete the checked Playlists.

Note: You cannot delete the System Groups (All, CDs, Internal, or Playlists).

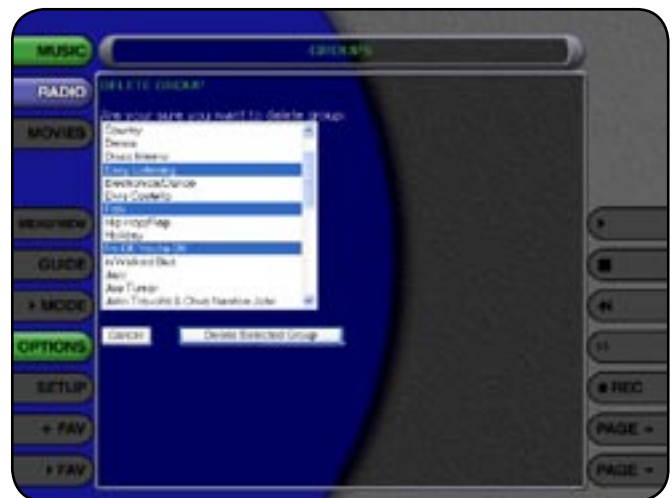
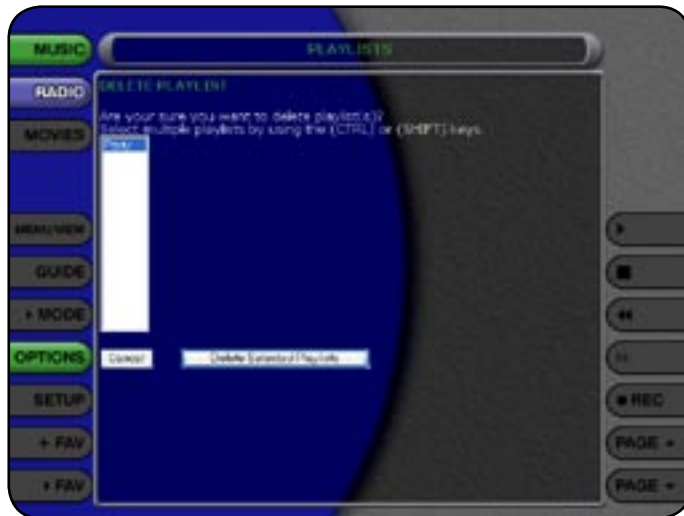

Setting User Preferences

SETTING USER PREFERENCES

User preferences are available to specify global configuration options and preferred system settings by accessing the Setup Menu. To access any of these global user preferences, Select the SETUP button to display the Setup Menu and then select any menu item.

NOTE: these User Preferences control the preferences of the FireBall you are connected to. To adjust the User Preferences of the web pad itself, use the Windows XPe Control Panel.

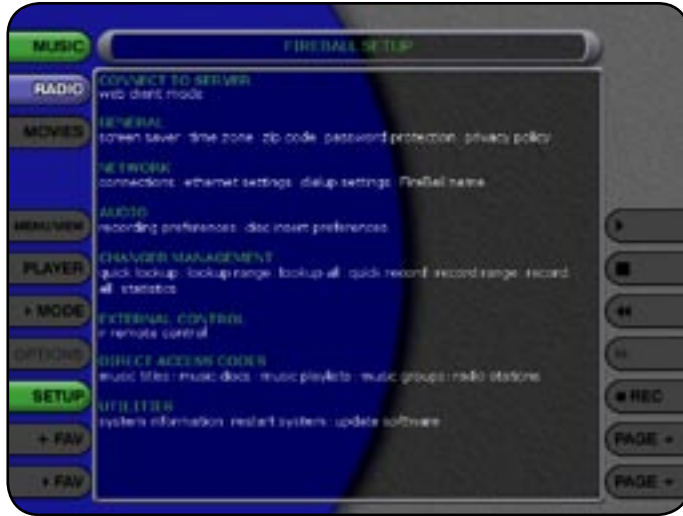

SELECTING THE CLIENT MODE

The FireBall Web Interface for the Web Pad can operate in two different modes:

- Remote Control Mode
- Streaming Music Client Mode

Remote Control Mode is the default mode and controls your FireBall playback system remotely. This means that when you play, pause, stop, or use any other transport control, the FireBall itself is affected. The FireBall is the playback device and the web pad is the controller.

When you set the Client Mode to Streaming Music Client Mode, the Web Pad becomes the playback device. This means that anytime you play, pause, stop, or use any other transport control, the Web Pad's playback system is affected. This mode is useful because the Web Pad becomes another "zone". This means that someone in the main room where your FireBall is located can play one song while you are in another room playing another song from the Web Pad.

Regardless of the Client mode, browsing the music library is independent of what is displayed or browsed on FireBall's main video output.

Note that when you are set to Streaming Client Mode, you will only have access to MP3 files through the Music source. FLAC audio files, Internet Radio and Movies are not streamable to the Web Pad. Also, the Setup menus will be disabled and hidden until you switch back to Remote Control Mode.

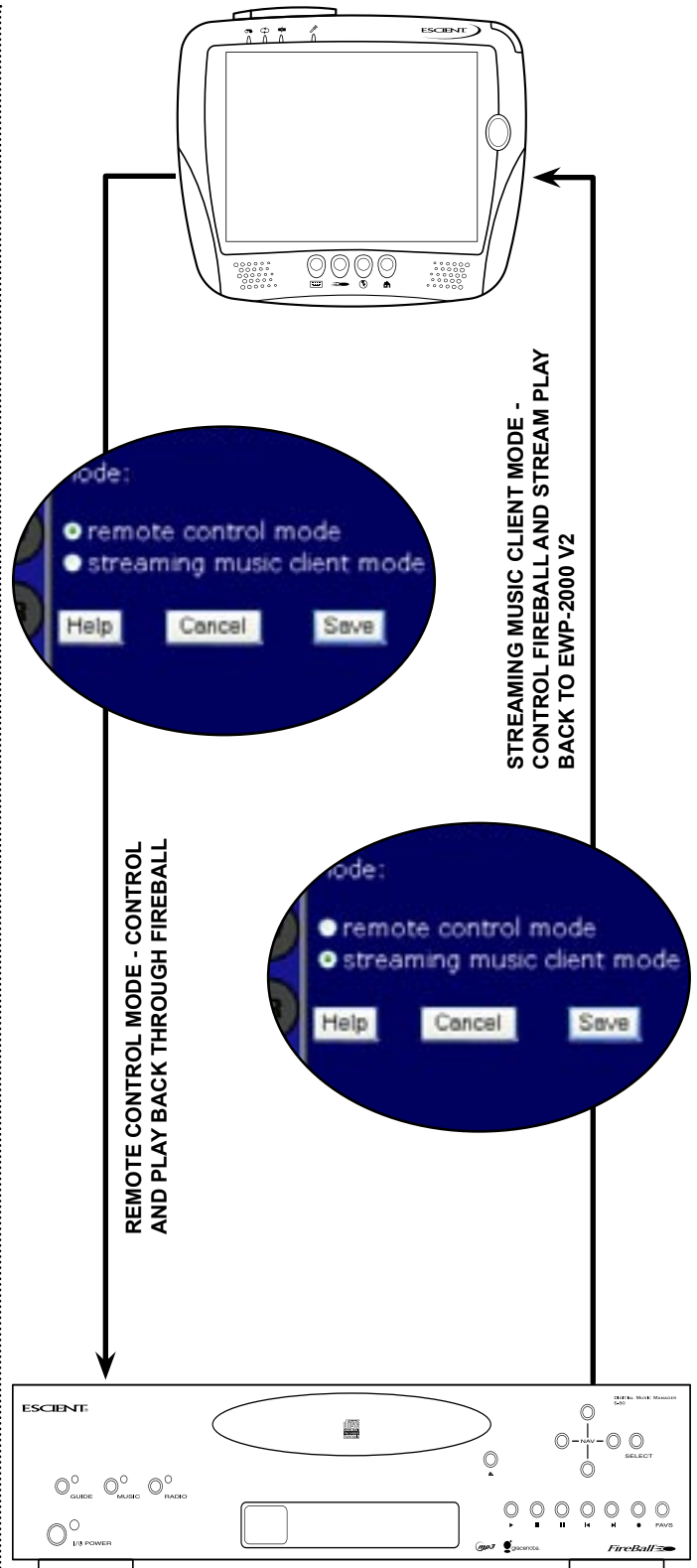

Setting User Preferences

SETTING THE SCREEN SAVER PREFERENCES

Screen Savers are provided for each source mode. Screen Savers provide two important functions, to prevent a static image from being displayed on the video output device for extended periods of time and to provide useful information to the user when activated.

Follow these steps to set your screen saver preferences:

1. Select the **SETUP** button to display the Setup menu.
2. Select the **Screen Saver Menu** item.
3. Select your **Screen Saver Preferences**

Activation Idle Time

You can specify the amount of idle time that FireBall will wait before activating the screen saver from 1 to 60 minutes.

Warning: Some televisions and plasma monitors are more susceptible to screen burn-in than others, therefore, we recommend using a low activation time (like 1 minute) to reduce the risk of burn-in.

Mode

Select either the Normal mode or Product Demonstration mode. The Normal mode displays the current title or station information while the Product Demonstration mode is intended for retail product demos during idle time.



SETTING YOUR TIME ZONE

Specify which time zone your FireBall is located in.

Follow these steps to set your Time Zone:

1. Select the **SETUP** button to display the Setup menu.
2. Select the **Time Zone Menu**
3. Select your select your Time Zone.

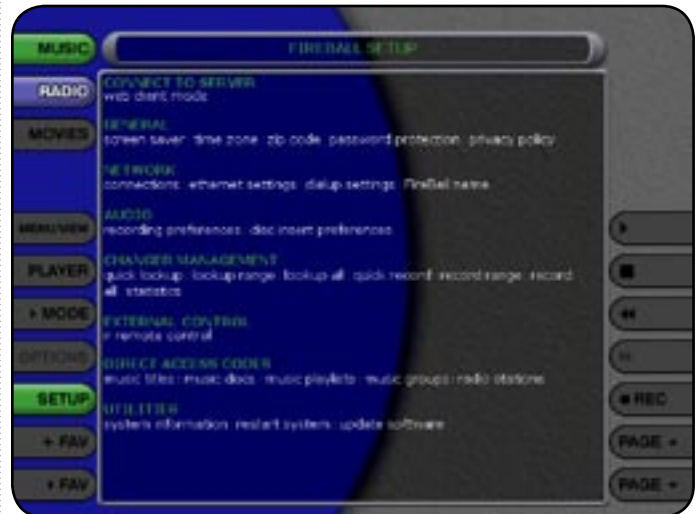

Setting User Preferences

SETTING YOUR ZIP CODE

Select US Zip Code or Canadian Postal Code. Your Zip Code or Postal Code is used to tell the automatic update manager when to connect to Escient for software updates.

Follow these steps to set your Zip Code:

1. Select the **SETUP** button to display the Setup menu.
2. Select the Zip Code Menu
3. Enter your Zip or Postal Code.

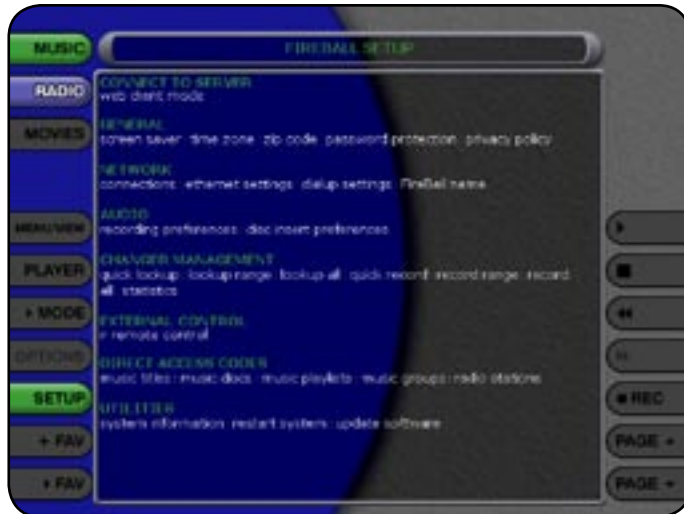

ENABLING PASSWORD PROTECTION

Optional Password Protection enables you to limit user access to the Setup Menu. This is useful to lockout the ability to change the global user settings and preferences.

Setting a System Password

Follow these steps to setup a new system password:

1. Using the popup keyboard, enter a 4 to 8 digit code into the password field.
2. Re-enter the same password into the VERIFY field.
3. Select the **SAVE** button to save your password and enable Password Protection on the Setup Menus.

- You must exit Setup and re-enter setup to activate the password protection.
- If a user password is specified, you will be prompted for your password whenever you press the Setup key on the remote.
- If the password entered matches the stored password, full access is granted to the user until the next power off cycle.
- If the password does not match, the user will be asked 2 more times to enter the correct password. If after the third try the password still does not match, the system will not allow the user access to the Setup menus.
- If the user does not specify a System Password, access to the Setup menu will be allowed whenever you press the Setup key.



Removing a System Password

Follow these steps to remove the system password:

1. Select the **SETUP** button and enter your existing system password.
2. Select the **Clear** button. The password and verify fields will be cleared.
3. Select the **SAVE** button to save the settings.

You will now be able to enter Setup without entering a password.

CHOOSING YOUR NETWORK CONNECTION

Setting User Preferences

FireBall supports two built-in networking methods, Ethernet and Dialup Modem. Your FireBall must be connected to the Internet in order to lookup disc information, download software updates, and access Internet Radio.

If you have a broadband Internet connection such as a cable modem, DSL, or ISDN line, select Ethernet and connect FireBall to your Ethernet network. You may need additional networking hardware (like an Ethernet hub) to join your FireBall to your Ethernet network. See your Escient dealer for more information about home networking.

If you have a dialup ISP (Internet Service Provider (such as AOL, Compuserve, Earthlink, MSN etc...)) select the Dialup Modem button.

Follow these steps to select your network connection:

1. Select the **SETUP** button to display the Setup menu.
2. Select the **Connections** Menu item under **Network**.
3. Select either **ethernet** or **dialup modem**.

Note: Changing your Network Connection will disconnect the Web Pad from the FireBall as the network interface is reset. You will have to manually reconnect to the FireBall using the FireBall Connect application on the desktop.

Ethernet Settings



Ethernet is the preferred networking choice which provides you with the best network performance and allows your FireBall to act as a "server" to deliver your music collection throughout your home network using the optional FireBall-MP150 Music Players.

Ethernet networks require that you configure each device on the network with a valid "address". These addresses are usually configured automatically by your network hardware. If your PC is setup using Dynamic or "DHCP" addressing, you should most likely use the same for your FireBall.

Connect your FireBall to your Ethernet network using the included Ethernet cable and then follow these steps to specify your Ethernet settings:

1. Select the **SETUP** button to display the Setup menu.
2. Select the **Ethernet Settings** Menu item under **Network**.
3. Select **Dynamic** for automatic address configuration or **Static** if you want to manually enter your TCP/IP address information.

If you select Static TCP/IP addressing, you will need to obtain a valid IP address, subnet mask, DNS server, and gateway addresses from your network administrator.

NOTE: CHANGING YOUR NETWORK CONNECTION WILL DISCONNECT THE WEB PAD FROM THE FIREBALL AS THE NETWORK INTERFACE IS RESET. YOU WILL HAVE TO MANUALLY RECONNECT TO THE FIREBALL USING THE FIREBALL CONNECT APPLICATION ON THE DESKTOP.

Dialup Settings

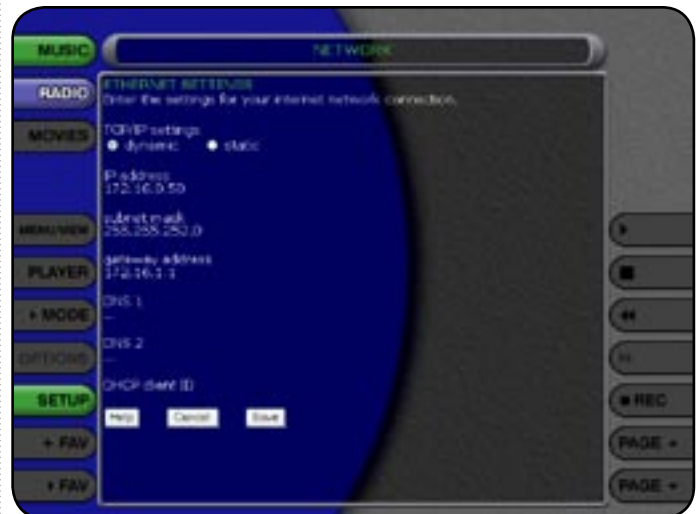

Setting User Preferences

If you are going to use a dialup ISP to connect your FireBall to the Internet, you must provide information for your selected ISP. This information can be obtained by contacting your ISP or from your PC, if you already use it to connect to the Internet.

Connect your FireBall to your phone line using the included phone cable and then follow these steps to specify your Dialup Modem settings:

1. Select the **SETUP** button to display the Setup menu.
2. Select the Dialup Settings Menu item under Network.
3. Enter your login or user name.
4. Enter your password.
5. Enter 1 or 2 dialup access numbers obtained from your ISP.
6. Select your dialing method: Tone or Pulse.
7. Enter any required dialing prefixes you may need for your phone system such as '9' to get an outside line.
8. If you have Call Waiting service on your phone line, you should enter “*70,” (or any other code) to temporarily disable it while using FireBall. This prevents a Call Waiting call from interrupting any FireBall Internet functions that may be in progress, such as updating.
9. Finally select which Provider you are using: AOL, CompuServe or Other.

SETTING THE FIREBALL SERVER NAME

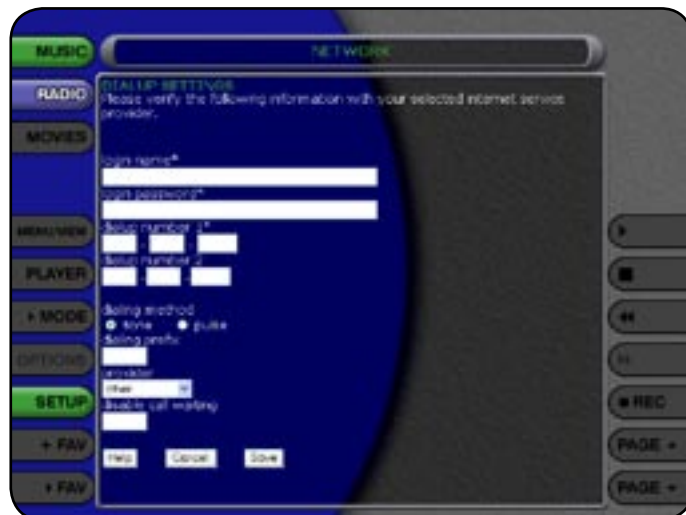

Your FireBall can act as a “server” delivering audio to optional remote FireBall “clients” over a local network. This allows you to control it remotely over a network using a standard web browser and allows Network File Sharing to your PC for backup and import features. The FireBall Name allows you to easily locate and connect to your FireBall by name.

Follow these steps to enter a name for your FireBall:

1. Select the **SETUP** button to display the Setup menu.
2. Select the FireBall Name menu item under Network.
3. Enter a name for your FireBall using the popup keyboard. For example: “Living Room” or “Home Theater” might be a name which helps identify which FireBall you want to connect to.

SELECTING THE AUDIO ENCODER TYPE



Setting User Preferences

You can specify which audio encoder (MP3 or FLAC) you want to use for recording audio to your FireBall. The MP3 format allows the most flexibility and compatibility for efficiently storing many audio files while the FLAC format uses considerably more space than MP3 files, but preserves an exact bit-for-bit recording of the original, using half the space when compared to the full 44.1k CD audio format.

NOTE: YOU CANNOT STREAM FLAC TO THE WEB PAD. ONLY MP3 FILES CAN BE STREAMED.

Follow these steps to select an audio encoder:

1. Select the **SETUP** button to display the Setup menu.
2. Select the **Recording Preferences** menu item under **Audio**.
3. Select **MP3 or CD Quality (FLAC)** as your preferred encoder
4. If you selected **MP3** as your preferred encoder, select a bitrate.

The MP3 bitrate is used to determine the relative quality and compression level. The higher the bitrate, the better quality and more space each song will occupy on the hard drive. Selecting a lower bitrate will provide lesser quality audio and will use less space for each song, allowing you to store more songs on your FireBall.

FLAC audio will always take up approximately 50% of the original WAV/AIFF file size. The FLAC compression level has been optimized to FireBall's processor speed and is not user adjustable. Creating a mix CD using FLAC audio files creates a CD which is identical to the original, thus it is referred to as "CD Quality".

SETTING THE DISC INSERT PREFERENCES



You can specify what to do with new discs inserted into FireBall's front panel CD drive. Display and Play will display the information for the disc and then play the disc. Record and Eject assists in bulk recording, allowing you to insert disc after disc, automatically recording then ejecting each one.

Follow these steps to set the Disc Insert Preferences:

1. Select the **SETUP** button to display the Setup menu.
2. Select the **Disc Insert Preferences** menu item under **Audio**.
3. Select **Display and Play** or **Record and Eject**.

Record and Eject will use the current Recording Preferences to record each disc to your internal hard drive. The Record Select Guide will not be displayed as all tracks are automatically selected and recorded to the internal hard drive. Use the Delete Music feature to delete any unwanted tracks.

MANAGING EXTERNAL CHANGERS

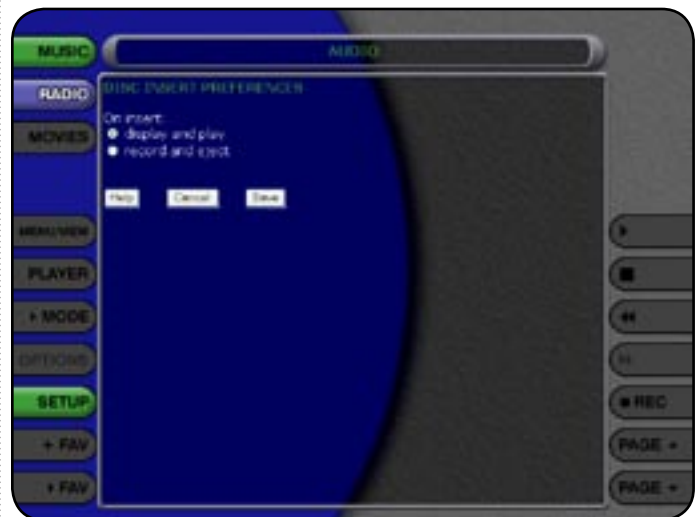

The disc information that FireBall displays on your TV screen is NOT included on the original CDs that you recorded or loaded into your changers. The artist name, album name, track list, and album cover art are supplied by Escient and it's partners. This information is downloaded from the Escient's servers to your FireBall, using your Internet connection. This process is referred to as "Looking up Disc Information".

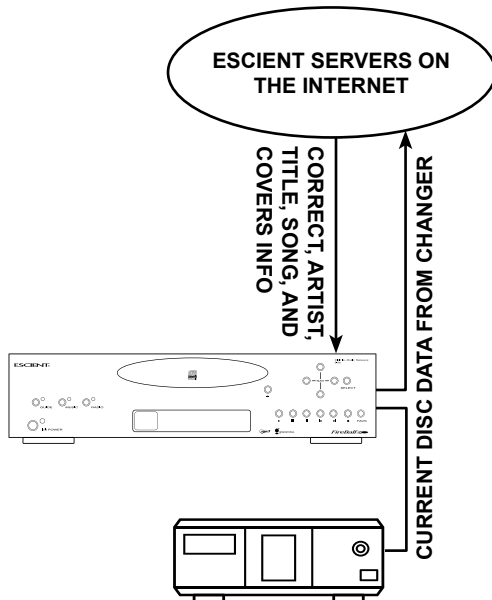

Automatically Getting Disc Information

Once your changers are connected to FireBall and loaded with CDs, all you have to do is close the changer door and in a few seconds FireBall will begin looking up the disc information from each disc in each changer.

Quick Lookup checks each previously empty slot in the changers to see if any new discs were added, and then checks each previously occupied slot in the changer to see if any discs were removed.

One by one, the Table of Contents is read from each CD and compared to the local music database or the Gracenote CDDDB™ using your Internet connection, as FireBall builds your Music Library. As each disc is accessed and looked up, the Quick Lookup screen is updated to display the disc's information and cover art. When all of the discs are looked up, the Music Guide will be displayed.

You can manually run Quick Lookup at any time by following these steps:

1. Select the **SETUP** button to display the Setup menu.
2. Select the **Look up Discs** menu item under **Changer Management**.
3. Select the **Quick Lookup** menu item.
4. FireBall will perform a Quick Lookup for each new disc.

Warning: Quick Lookup checks for newly added and removed CDs each time it runs. Do not remove CDs and replace new CDs into the same changer slots without running Quick Lookup in-between, or FireBall will not know that these slots have changed.

If you want to reuse the same slots, first remove your CDs, let Quick Lookup run, then add new CDs to the same slots.

Getting Disc Information for a Range of Discs

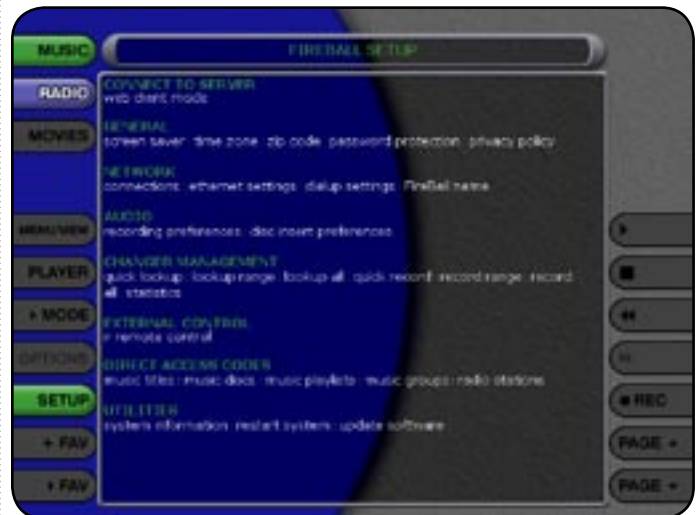

Setting User Preferences

If you want to lookup the disc information for a specific range of slots in a changer, you can use the Lookup Range feature.

Follow these steps to lookup a range of changer slots:

1. Select the **SETUP** button to display the Setup menu.
2. Select the **Lookup Discs** menu item under Changer Management.
3. Select the **Lookup Range** menu item.
4. Enter a valid range of slots to lookup. If you have more than 1 changer, select which changer you want to use.
5. Select the **CHECK RANGE** button.
6. The **Lookup Range** screen displays the progress and results for each disc in the selected range.

Getting Disc Information for All Discs

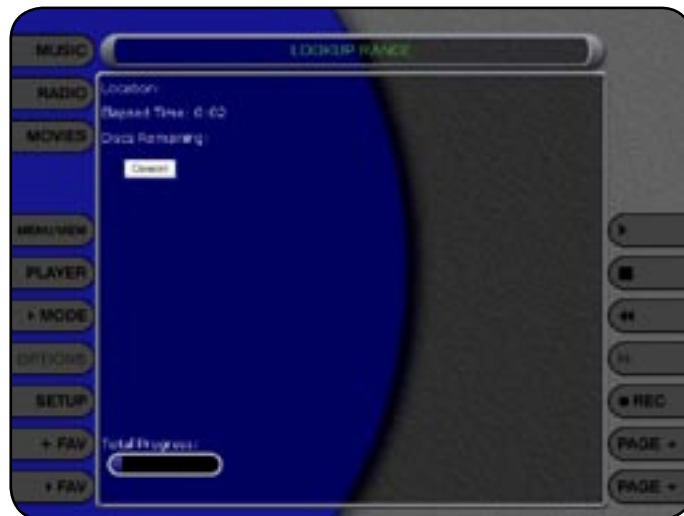
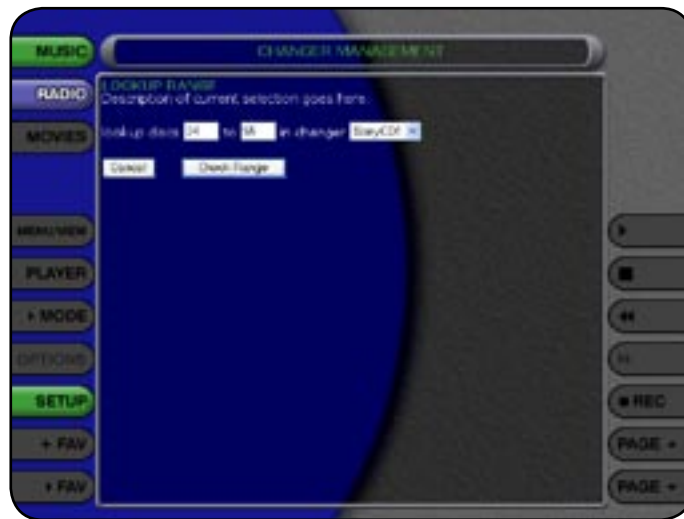

If you want to lookup the disc information for all discs in all changers, you can use the Lookup All feature.

Follow these steps to lookup all discs in all changers:

1. Select the **SETUP** button to display the Setup menu.
2. Select the **Lookup Discs** menu item under Changer Management.
3. Select the **Lookup All** menu item.
4. The **Lookup All** screen displays the progress and results as each disc in each changer is looked up.

RECORDING FROM EXTERNAL CHANGERS



Setting User Preferences

In addition to manually loading and recording CDs one by one using the front panel CD drive, you can record as many CD as you want directly from your external changers.

The advantage of recording multiple discs from your changers is that you don't have to sit there and unload/load each disc after it's recorded, however there is the disadvantage that external recording must occur in real-time, at 1x record speeds, taking up to several weeks to complete for large music collections.

External Changer recording uses the same recording preferences mentioned above in the "Selecting the Audio Encoder Type" and "Handling duplicate Tracks" sections.

Note: Make sure you have both the digital and analog audio connections from your changers connected to FireBall. FireBall will use the digital inputs first, but if there is digital copy protection on a CD, FireBall will then attempt to use the analog audio inputs to record the protected CD.

Automatically Recording CDs

You can easily record changer based CDs to your FireBall's internal hard drive using the Quick Record feature. Quick Record will record all tracks from newly added CDs which are NOT already recorded to your FireBall, in one easy step.

Follow these steps to automatically record changer CDs to your FireBall:

1. Select the **SETUP** button to display the Setup menu.
2. Select the Record Discs menu item under Changer Management.
3. Select the Quick Record menu item.
4. FireBall will determine which changer discs have not been recorded to the internal hard drive, and proceed with recording each disc (all tracks) to the internal hard drive.

Recording a Range of CDs

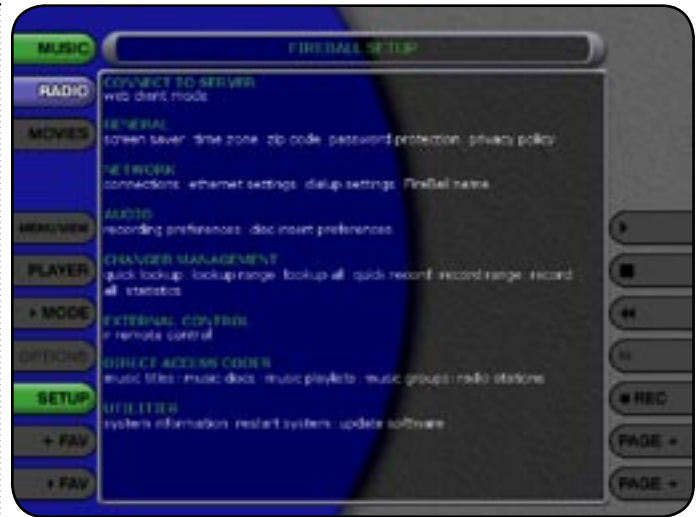

Setting User Preferences

If you want to record a specific range of slots in a changer, you can use the Record Range feature.

Follow these steps to record a range of changer slots:

1. Select the **SETUP** button to display the Setup menu.
2. Select the **Record Discs** menu item under Changer Management.
3. Select the **Record Range** menu item.
4. Enter a valid range of slots to record. If you have more than 1 changer, select which changer you want to use.
5. Select the **RECORD RANGE** button.
6. The **Record Range** screen displays the recording progress for each disc in the selected range.

Recording All CDs

If you want to record all discs in all changers, you can use the Record All feature.

Follow these steps to record each disc in all changers:

1. Select the **SETUP** button to display the Setup menu.
2. Select the **Record Discs** menu item under Changer Management.
3. Select the **Record All** menu item.
4. The **Record All** screen displays the recording progress for each disc in each changer.

FIREBALL UTILITIES

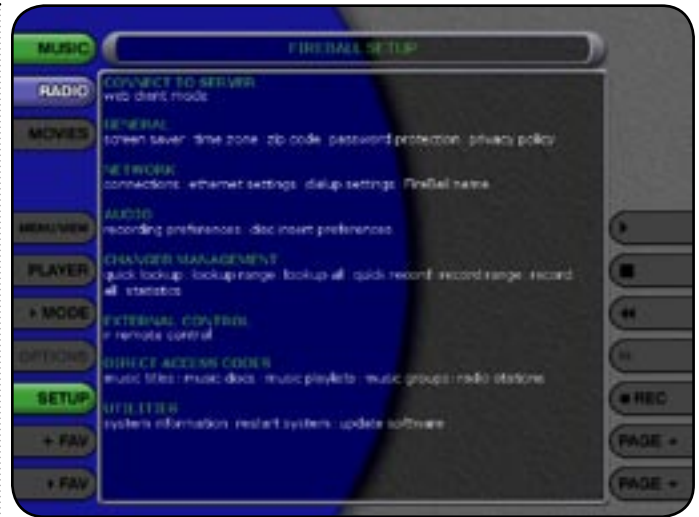

Setting User Preferences

Getting Information about Your FireBall

Information about your FireBall hardware and software is available under the Utilities menu. This information is useful for troubleshooting any problems you may encounter with your network connection or verifying the current software versions.

Follow these steps to view the FireBall system information:

1. Select the **SETUP** button to display the Setup menu.
2. Select the System Information menu item under Utilities.

Restarting the System

There are two ways of manually performing a full restart or reboot of the FireBall system, one using the front panel power button and the other using the Restart System menu.

Follow these steps to restart the system using the front panel Power Button:

1. Select and hold the power button for 4 seconds.
2. When the blue LED on the front panel begins to flash, release the power button.
3. When the blue LED on the front panel glows solid blue (standby mode), FireBall is ready to use.
4. Select and release the Power button to turn on FireBall.

Follow these steps to restart the system using Utilities menu:

1. Select the **SETUP** button to display the Setup menu.
2. Select the Restart System menu item under Utilities.
3. Confirm that you want to restart the system and select the **RESTART** button.
4. When the blue LED on the front panel glows solid blue (standby mode), FireBall is ready to use.
5. Select and release the Power button to turn on FireBall.

Updating the Software

FireBall will automatically check the Escient server once a week for any FireBall software updates, and automatically install them. You can also manually check for a software update.

Follow these steps to manually update the software:

1. Select the **SETUP** button to display the Setup menu.
2. Select the Update Software menu item under Utilities.
3. Confirm that you want to update the current software.
4. FireBall will connect to Escient and compare the current software version with the latest release. If a newer version of the FireBall software is available, it will be downloaded and installed.

ADDITIONAL INFORMATION

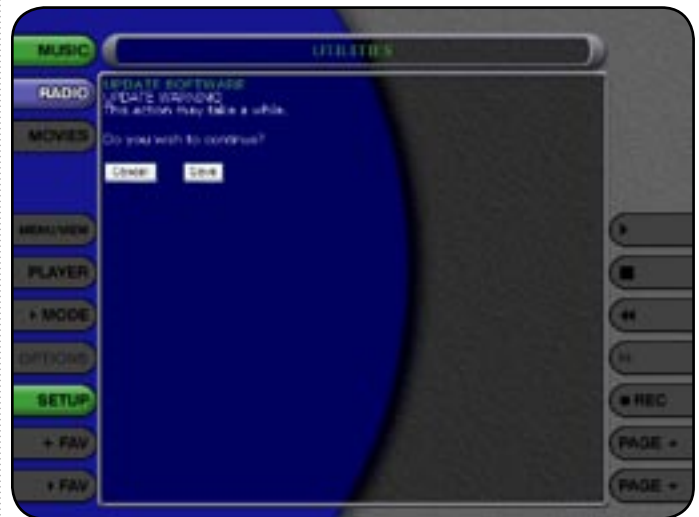
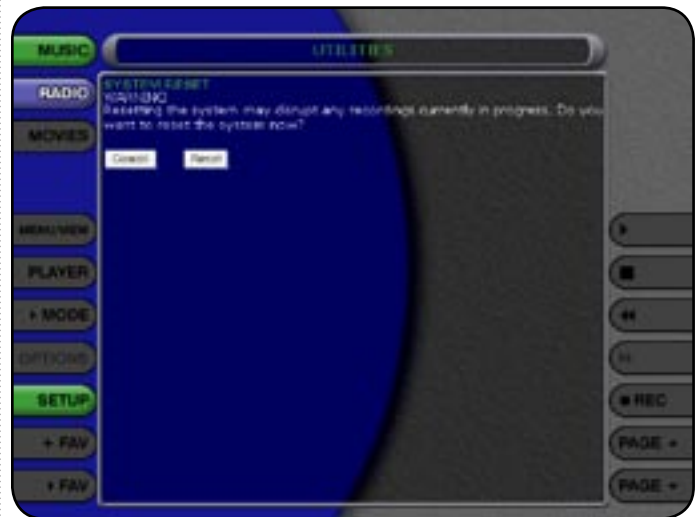

ESCIENT SUPPORT

Contact your dealer or Escent's Customer Support group.

Hours: Monday - Friday 9:00am - 7pm EST
Phone: 800-372-4368 Press "2" for Sales, or "3" for Support
Fax: 317-616-6790
Internet: www.escent.com
Email: support@escent.com

Please have the following information ready for the Escent Customer Support technician:

- Product Serial Number
- Model Number
- Date of Registration or Purchase
- Place of Purchase

SPECIFICATIONS

Specifications are subject to change without notice. Please check the Escent web site for any changes to the specifications.

System

- Transmeta Crusoe™ processor for performance, "instant-on" mode, and extended battery charge intervals
- 8.4" TFT touch display in robust yet light and thin metal alloy enclosure
- 512 MB Flash Memory and 256 MB RAM
- Wireless LAN and WAN capable
- Management Tools for installation, updates, monitoring and control

Web Access and Embedded Applications

- Windows XPe operating system with IE 6 and Windows Media Player 9
- Supports Java Virtual Machine, Acrobat PDF Viewer, and
- Macromedia Flash
- Microsoft Windows XP applications compatible

Thin Client/Server Computing

- RDP and ICA protocols for Microsoft and Citrix Terminal Servers
- Terminal Emulation suite, including IBM 3270 & 5250, DEC VT, Wyse, and HP
- Secure access to software services through Virtual Private Network
- (VPN) support

PC Companion

- Share and view information and data with desktop PCs
- Run applications and access data on Windows XP Professional PC

Wireless Network Support

- IEEE 802.11b WLAN, standard (Up to 11 Mbps)
- 802.11a, 802.11g, Bluetooth and wireless WAN optional

Tethered Network Support

- 10/100 BaseT Ethernet LAN via PCMCIA, CF, or USB interface
- Dialup modem via PCMCIA, CF, or USB interface

Dimensions/Weight

- Unit H x W x D: 7.9" (200 mm) x 9.6" (240 mm) x 0.8" (18 mm)
- Unit Weight: 1.9 lbs. (0.86 kg), excluding AC/DC adapter, protectivejacket, and secondary battery

Regulatory/ Environmental

- FCC-B , CE, and UL
- Operating Temperature: 0°~40°C
- Humidity: 0%~90%

Standard Package & Accessories

- EWP-2000 V2 Unit with internal Li-Ion Battery Packs
- Battery Charging Cradle and AC-DC Adapter
- Protective Jacket with Shoulder Strap
- Optional: Wall, Desktop, Vehicle, mount Docking Cradle
- Optional: External Battery Charger
- Optional: Automobile DC Adapter Kit

Optional Accessories

- External Battery Pack (Li-Ion, 20W) - External, snap-on, hot-swappable battery pack - more than doubles duration of mobile operation.
- External Battery Charger Kit (with AC Adapter & Power Cord) - Recharges external battery pack "offline" without affecting usage of device.
- Screen Protectors for 8.4" Display (10 sheets per package) - Replaceable custom-fitted screen protectors shield your display screen from fingerprints, scratches and dust, while maintaining comfortable input.
- Stylus - Proper tool to operate the Tablet's touch display. Available in kits only; 3 pieces per kit.
- Wall-Mount Cradle Assembly - VESA-compatible, Wall-, Desk-, and Vehicle-Mountable structure offers Tablet storage, security, and connectivity to power, USB accessories, and PCs.
- Enhanced Cradle Assembly - Tablet storage and support with ports to AC power, Input Devices, common USB peripherals and PC systems.
- Protective Jacket and Shoulder Strap - Custom designed and fitted to protect your Tablet, and for convenience in mobile operation
- Internal Battery Pack (Li-Ion, 14W) - Replacement or backup spare for internal battery pack.
- Automobile Power Adapter (12V) - Use with power outlets in vehicles to facilitate device usage and/or battery recharge.
- Carrying Pouch - Professionally designed and custom fitted for light protection and handling of the Tablet. (Not intended for usage with Protective Jacket and External Battery Pack.)
- Mini-USB Keyboard with 1-Port Hub (US Only) - 88-key USB keyboard in compact form factor can be used directly with the device or connected through the Cradle. Actual device may appear different from picture shown.
- AC-DC Power Adapter (12V, 3.5A, 42W) with Power Cord - Facilitates battery recharge or Tablet operation through direct connection to the Tablet or via the Power Jack in the device Cradle. (Choice of US, UK or EU power cord.)
- Tablet Carrying Case - Custom-designed case for convenient usage of device with keyboard and power supply. The secured display is provided with adjustable support and protection in deployment and as well as transport.