

SAMSUNG

**OWNER'S INSTRUCTIONS
MANUAL DE INSTRUCCIONES
MANUEL D'UTILISATION
MANUAL DE INSTRUÇÕES
ISTRUZIONI PER L'USO**

ENGLISH

**AW127JE/B
AW126JE/B
AW147JB
AW146JB
AW12A6(A7)JD
AW12A6(A7)JA
WC12ZR**

**Window-type Room Air Conditioner (Cool)
Acondicionador de aire doméstico sistema de tipo ventana (Refrigeración)
Climatiseur de type Fenêtre (Refroidissement)
O ar Condicionado de Window-Type (Refrigeração)
Condizionatore d'aria per ambienti da finestra (Raffreddamento)**

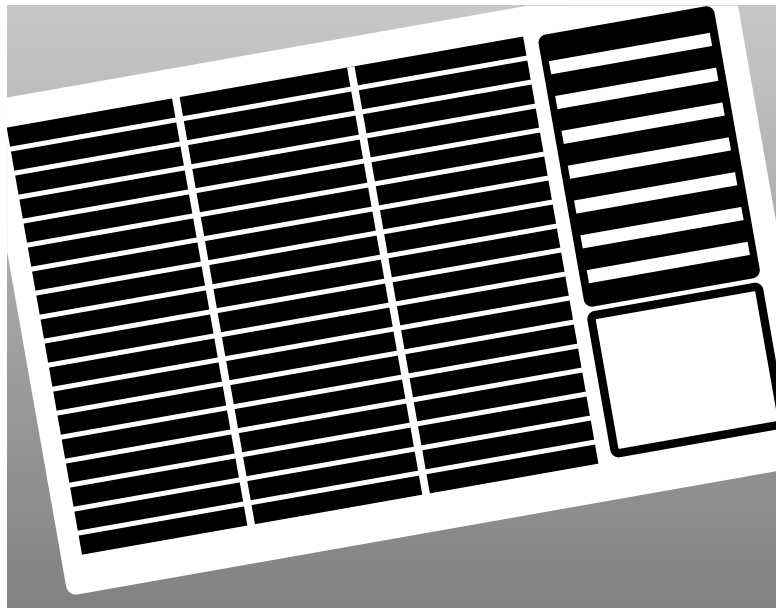

Safety Precautions

The following safety precautions must be taken when installing and using your air conditioner.

1 *The air conditioner must be plugged into its own specific power source, which must be installed in compliance with national wiring, earthing and safety regulations.*

Depending on national regulations and your specific installation, you may need to install:

- ◆ *A circuit breaker*

For further information on electrical requirements, contact a professional electrician.

This air conditioner must be connected by a licenced electrician.

This device must be installed according to the national electrical rules.

2 *Make sure that the unit is correctly ventilated at all times; do NOT place clothing or other materials over it.*

3 *NEVER spill liquid of any kind into the unit. Should this happen, unplug the unit and contact your installation specialist.*

4 *Do NOT insert anything between the air outlet blades, as the inner fan may be damaged and you may be hurt. Keep children away from the unit.*

5 *ALWAYS ensure that the power cable is in good condition. Make sure that it is not walked on or damaged by items placed on or against it. If the power cord is damaged in any way, it must be replaced by an approved power cord available from the manufacturer or its service agent.*

6 *Do NOT attempt to repair the unit yourself. If it is damaged in any way, contact:*

- ◆ *An approved service center*
- ◆ *The outlet at which the air conditioner was purchased*

7 *Do NOT place any obstacles in front of the unit.*

8 *If the remote control will not be used for a long time, remove the batteries.*

9 *Before throwing out the device, it is necessary to pull back the battery cells and get rid of them safely.*

10 *The appliance is not intended for use by young children or infirm person without supervision; young children should be supervised to ensure that they do not play with the appliance.*

CAUTION

The manufacturer do not take the responsibility of the accident happened because the air conditioner is not fixed firmly or installed securely, during installing or using the product. In case you have difficulty in installation, you must ask for an installation specialist help. The accident will be happened in case of installing improperly.

Contents

◆ PREPARING YOUR AIR CONDITIONER	
■ Safety Precautions	2
■ Air Conditioning Unit - Main Parts, Buttons and Display	4
■ Remote Control Buttons	5
■ Getting Started	6
■ Inserting the Remote Control Batteries	7
◆ OPERATING YOUR AIR CONDITIONER	
■ Cooling Your Room	8
■ Airing Your Room	9
■ Adjusting the Air Flow Direction Horizontally	10
■ Adjusting the Air Flow Direction Vertically	10
◆ PROGRAMMING YOUR AIR CONDITIONER	
■ Switching the Unit Off Automatically (Off Timer)	11
■ Cancelling the Off Timer	11
◆ RECOMMENDATIONS FOR USE	
■ Operating Recommendation	12
■ Temperature and Humidity Ranges	12
■ Cleaning Your Air Conditioner	13
■ Solving Common Problems	14
■ Installing a Filter	15
■ Technical Specifications	15
◆ METHOD OF INSTALLATION	16

Air Conditioning Unit - Main Parts, Buttons and Display

* The design and shape are subject to change according to the model.

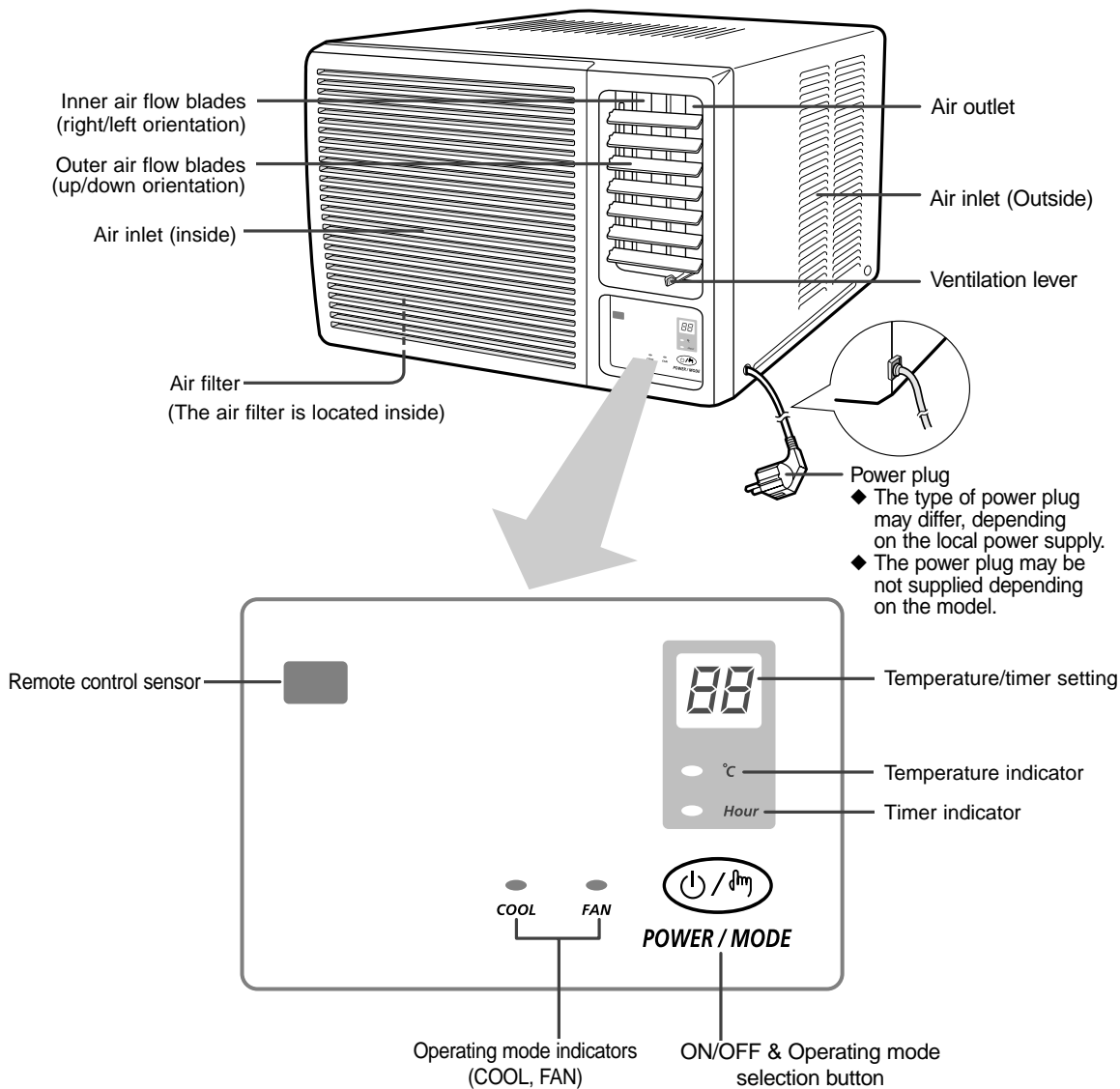

Remote Control - Buttons

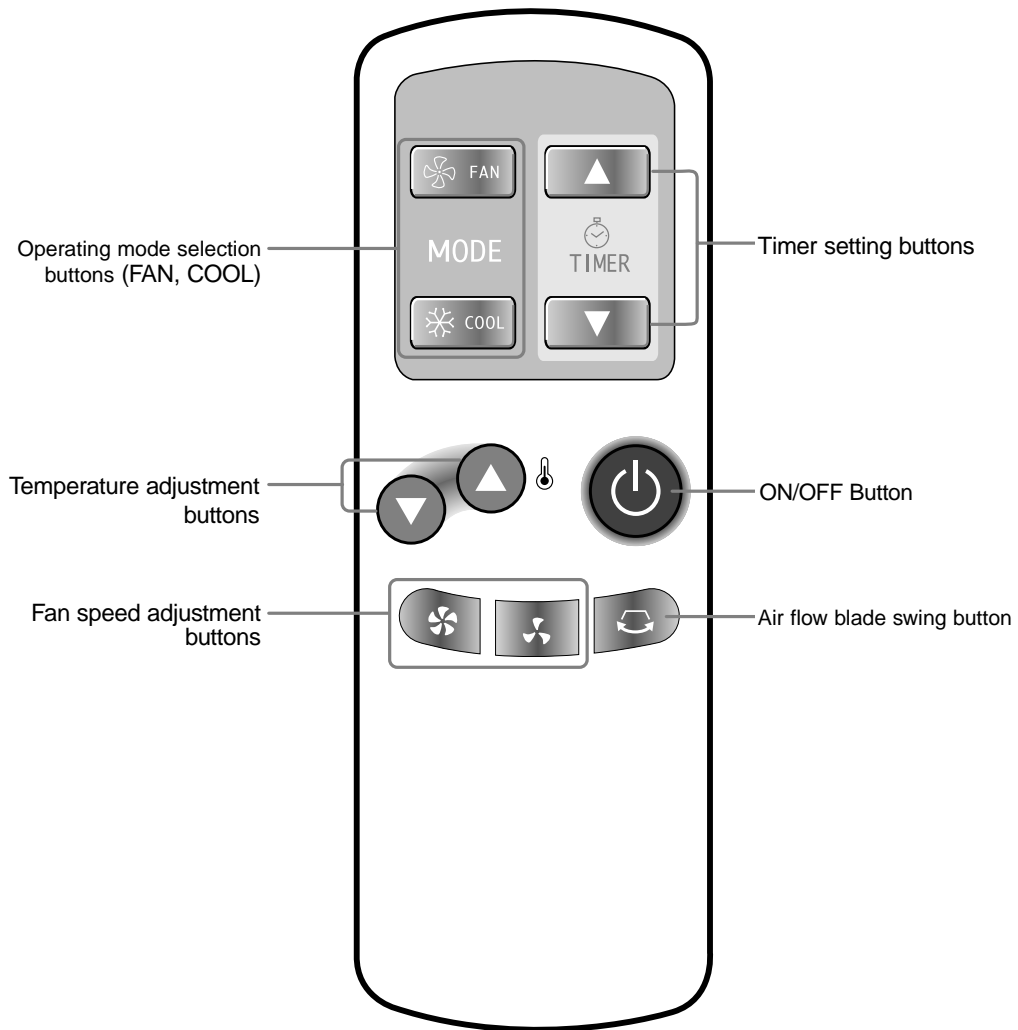

Getting Started

You have just purchased a window-type room air conditioner and it has been installed by your installation specialist.

Your Owner's Instructions contain much valuable information on using your air conditioner. Please take the time to read them as they will help you take full advantage of the unit's features.

The booklet is organized as follows.



- ◆ *The following figures are shown on pages 4 and 5:*
 - *Air conditioning unit (main parts, buttons and display)*
 - *Remote control (buttons)*

They will help you find the buttons and understand the symbols displayed.
- ◆ *In the main part of the document, you will find a series of step-by-step procedures for each function available.*

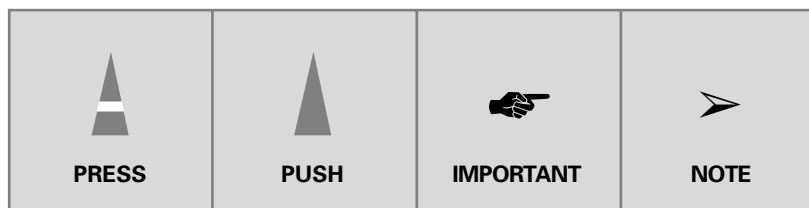
The illustrations in the step-by-step procedures use four different symbols:



Moreover, applicable, wherever the illustrations show the positions of the buttons on both the remote control and the unit itself.

For the...	The illustrations have a...
Remote control	Dark background. Example: 
Unit itself	White background. Example: 

Inserting the Remote Control Batteries

You must insert or replace the remote control batteries when:

- ◆ *You purchase the air conditioner*
- ◆ *The remote control does not work correctly*



Use two LR03 (R03) 1.5 V batteries. Do not use old batteries or different kinds of batteries together.

Batteries may be completely discharged after 12 months, even if they have not actually been used.

- 1 Push the battery cover on the rear of the remote control with your thumb in the direction of the arrow and remove it.
- 2 Insert the two batteries, taking care to respect the polarities:
 - ◆ + on the battery with + on the remote control
 - ◆ – on the battery with – on the remote control
- 3 Close the cover by sliding it back until it clicks into place.

Result: You can control all the functions on your air conditioning unit directly from your seat, using the remote control.

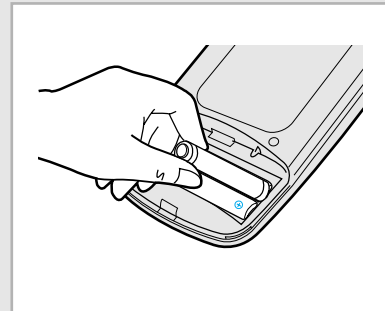
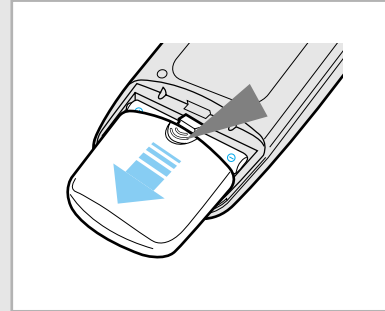

Cooling Your Room

Remote Control



Control Panel

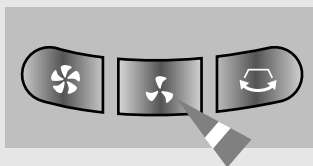
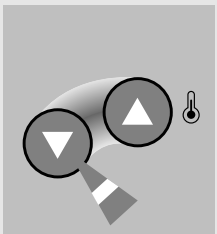
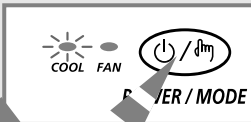
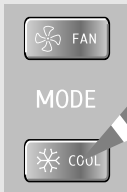
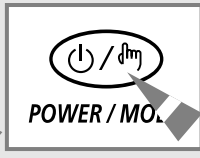

You must select the Cool mode if you wish to lower the temperature in your room. You can also set the fan speed.

- If necessary, press the (On/Off) button.

Result:

 - ◆ The operating mode indicator (COOL or FAN) on the unit comes on.
 - ◆ The air conditioner starts up in the mode selected when the unit was last used.
 - ◆ The unit beeps twice.

The air conditioner is fitted with a protection mechanism to prevent the unit from being damaged when it is started immediately after being:

 - ◆ Plugged in
 - ◆ Stopped

It will start up normally after a three-minute rest period.
- If the COOL indicator is not lit up on the unit:

 - ◆ Press the COOL button on the remote control

or

 - ◆ Press the POWER/MODE button on the unit one or more times until the COOL indicator lights up

Result:

 - ◆ The unit beeps each time you press POWER/MODE.
 - ◆ The air conditioner starts up in Cool mode.

➤ You can change modes at any time.
- To adjust the temperature, press the or buttons on the remote control one or more times until the required temperature is displayed. Possible temperatures are between 18°C and 30°C inclusive.



Result:

 - ◆ Each time you press the temperature buttons:
 - The temperature is adjusted by 1°C and displayed on the control panel
 - The unit beeps
 - ◆ The air conditioner starts cooling if the room temperature is higher than the selected temperature.
- | To set the fan speed to... | Then... |
|----------------------------|--|
| High | Press the button on the remote control. |
| Low | Press the button on the remote control. |

Result: Each time you press a button, the unit beeps.
- To control the direction of the air flow, refer to page 10.



Airing Your Room

If the atmosphere in your room is stale, you can air it using the Fan feature and if necessary, evacuate the stale air outside.

- 1 If you wish to evacuate stale air outside, push the ventilation lever on the front of the unit to the right and the open position ().
Result: The air inside the room circulates and stale air is evacuated outside.
 Otherwise, push the ventilation lever to the left and the closed position ().
Result: The air simply circulates inside the room.

- 2 If necessary, press the  (On/Off) button.
Result:
 - ◆ The operating mode indicator (COOL or FAN) on the unit comes on.
 - ◆ The air conditioner starts up in the mode selected when the unit was last used.
 - ◆ The unit beeps twice.

- 3 If the FAN indicator is not lit up on the unit:
 ◆ Press the FAN button on the remote control
 or
 ◆ Press the POWER/MODE button on the unit one or more times until the FAN indicator lights up
Result:
 - ◆ The unit beeps each time you press POWER/MODE.
 - ◆ The air conditioner starts up in Fan mode.
 ➤
 - ◆ You can change modes at any time.
 - ◆ When the air conditioner is in Fan mode, the temperature is not displayed; moreover, you do not need to set the temperature.

4	To set the fan speed to...	Then...
	High	Press the  button on the remote control.
	Low	Press the  button on the remote control.
	<u>Result:</u>	Each time you press a button, the unit beeps.

- 5 To control the direction of the air flow, refer to page 10.

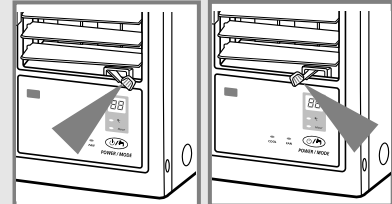

Remote Control

Control Panel

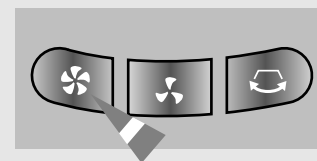
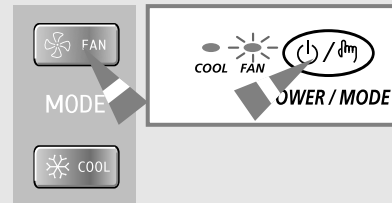

Adjusting the Air Flow Direction Horizontally

Remote Control

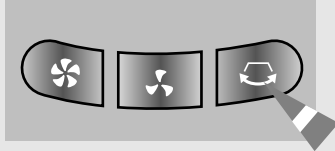

Depending on the position of the unit in your room, you can adjust the orientation of the inner air flow blades on the right-hand side of the unit, thus increasing the efficiency of the air conditioner.

- 1 Press the  button on the remote control.

Result: The inner blades swing automatically left and right.

- 2 To stop the blades moving left and right, press the  button again.

➤ To stop the blades in a specific position and orient the air flow in the corresponding direction, simply press the  button when the blades are in the desired position.

Adjusting the Air Flow Direction Vertically

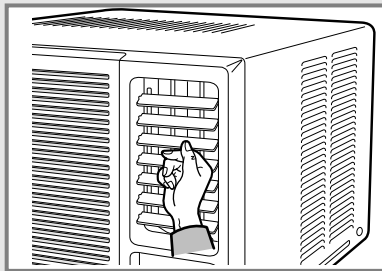

Again depending on the position of the unit in your room, you can adjust the orientation of the outer air flow blades on the right-hand side of the unit.

RECOMMENDATION

When...	Adjust the blades to face...
Cooling	Upwards.

Adjust the air flow blades to the desired position, by pushing them upwards or downwards.

- If you orient the air flow blades downwards and the unit operates in Cool mode for a long period of time, dew may:
- ◆ Form on the surface of the blades
 - ◆ Drip from the blades

Switching the Unit Off Automatically (Off Timer)

You can set the timer to switch the air conditioner off automatically at a given time.

Example: You wish to switch the unit off two hours after you have gone to bed.

- 1 If necessary, press the  (On/Off) button.
-
- 2 Select the required mode by pressing the appropriate button:
 - ◆ COOL or FAN on the remote control
 - ◆ POWER/MODE button on the unit (press it one or more times until the appropriate operating mode indicator lights up)
-
- 3 Set the operating time by pressing:
 - ◆ TIMER ▲ or ▼ on the remote control one or more times.

Example: To switch the unit off two hours after you have gone to bed, set the operating time to 2 hours.

Possible operating times are between 1 and 24 hours inclusive.

Result:

 - ◆ The Hour indicator flashes for about ten seconds.
 - ◆ The operating time is displayed and decreased automatically to indicate the remaining time.
 - ◆ The air conditioner switches off automatically when the operating time reaches zero.

➤ You can change your setting at any time.

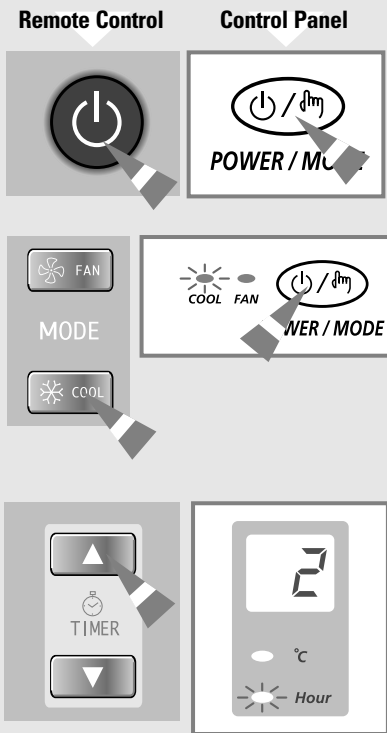

Cancelling the Off Timer

If you no longer wish to use the Off Timer that you have set, you can cancel it at any time.

To cancel the timer, press:

- ◆ TIMER ▲ or ▼ on the remote control one or more times until "--" is displayed.

Result:

- ◆ The unit beeps each time you press a button.
- ◆ The Hour indicator on the unit switches off.
- ◆ The air conditioner operates normally.

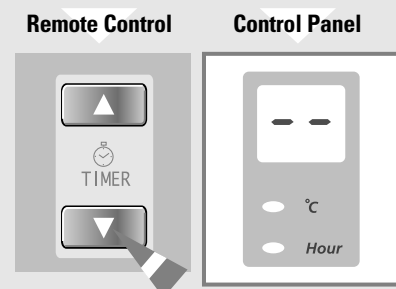

Operating Recommendation

Here is a recommendation that you should follow when using your air conditioner.

Topic	Recommendation
Power failure	If a power failure occurs when the air conditioner is operating, the unit is switched off. When the power returns, you must press  (On/Off) to restart it.

Temperature and Humidity Ranges

The following table indicates the temperature and humidity ranges within which the air conditioner can be used.

Mode	Indoor Temperature	Outdoor Temperature	Indoor Humidity
Cooling	21°C to 32°C approx.	21°C to 43°C approx.	80% or less

If the air conditioner is used at...	Then...
Higher temperatures	The automatic protection feature may be triggered and the air conditioner stopped.
Lower temperatures	A water leakage or some other malfunction may happen if the heat exchanger freezes.
Higher humidity levels	Water may condense on and drip from the surface of the unit if it is used for long periods.

Cleaning Your Air Conditioner

To get the best possible use out of your air conditioner, you must clean it regularly by two weeks to remove the dust on the air filter.

 Before cleaning your air conditioner, ensure that it is switched off and unplugged from the wall socket.



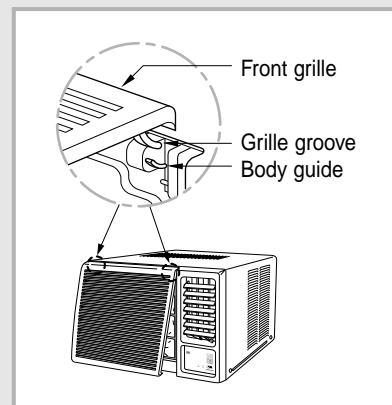
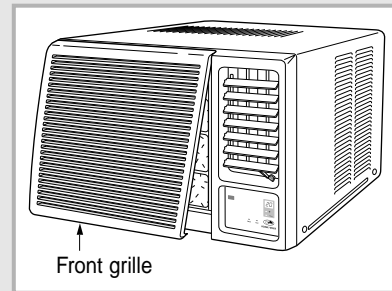

- 1 Open the front grille by pulling on the tabs of the unit.
 - The removal of the front grille makes it easier to clean the air conditioner. After opening the front grille, lift it up as much as possible, then pull down to release it.
- 2 Grasp the handle on the air filter and lift it slightly and then out to the front.
- 3 Remove all dust on the air filter with a vacuum cleaner or brush.
- 4 When you have finished, slide the air filter back into position.
- 5 Clean the outer surfaces with a damp cloth and mild detergent (do NOT use benzene, solvents or other chemicals). Wipe them dry with a clean, soft cloth.

➤ If you...	Then...
Will not be using the air conditioner for a long period of time	<ul style="list-style-type: none"> ◆ Set the fan going for a few hours to dry the inside of the air conditioner thoroughly. ◆ Switch the air conditioner off and unplug it from the wall socket. ◆ Clean the filter and outer surfaces.
Have not used the air conditioner for a long period of time	Set the fan going for a few hours to dry the inside of the air conditioner thoroughly.



Solving Common Problems

Before contacting the after-sales service, perform the following simple checks. They may save you the time and expense of an unnecessary call.

Problem	Explanation/Solution
The air conditioner does not operate at all	<ul style="list-style-type: none"> ◆ Check that the circuit breaker used for the air conditioner has not been triggered. ◆ Check that the power cable is plugged into a wall socket and the socket is switched on, if necessary. ◆ Check that the operating mode indicator (COOL or FAN) on the unit is lit up; if necessary press  (On/Off) on the remote control or unit.
The air conditioner does not operate with the remote control	<ul style="list-style-type: none"> ◆ Check that there are no obstacles between you and the unit. ◆ Replace the remote control batteries if necessary. ◆ Check that you are close enough to the unit (seven metres/yards or less).
No beep is heard when you press  (On/Off) on the remote control	<ul style="list-style-type: none"> ◆ Check that you are pointing the remote control at the remote control sensor on the unit. ◆ Replace the remote control batteries if necessary.
The air conditioner does not cool	<ul style="list-style-type: none"> ◆ Check that the correct operating mode has been selected COOL. ◆ The room temperature may be too low. ◆ Dust may be blocking the air filter; refer to page 13 for cleaning instructions. ◆ Check that there is no obstacle blocking the air flow into or out of the unit.
The air flow direction does not change when you press the  button	<ul style="list-style-type: none"> ◆ Check that the air conditioner has been switched on; if necessary, press  (On/Off) on the remote control or unit.
The timer is not correctly triggered	<ul style="list-style-type: none"> ◆ Check that the timer has been programmed correctly; refer to page 11.
Odours are permeated in the room during air conditioning	<ul style="list-style-type: none"> ◆ Air the room.

Installing a Filter

The air conditioner can be fitted with an Electrostatic filter to remove minute dust particles. The service life of the filter is approximately three months depending on the time during which the air conditioner is used.

- 1 Remove the vinyl packing from the filter.
 - Do not remove the packing from an electrostatic filter until you wish to use the filter, as it will lose its properties.
- 2 Open the front grille by pulling on the tabs of the unit.
- 3 Grasp the handle on the air filter and lift it slightly and then out to the front.
- 4 Remove the filter guard into the air filter.
- 5 Insert the Electrostatic filter in the filter holder and then re-assemble it in the original condition.

◆ Air purifying system

Model	Electrostatic filter
AW127JE/B AW147JB AW12A7JD AW12A7JA	supplied
AW126JE/B AW146JB AW12A6JD AW12A6JA WC12ZR	not supplied

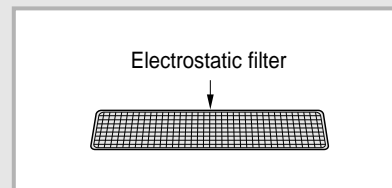
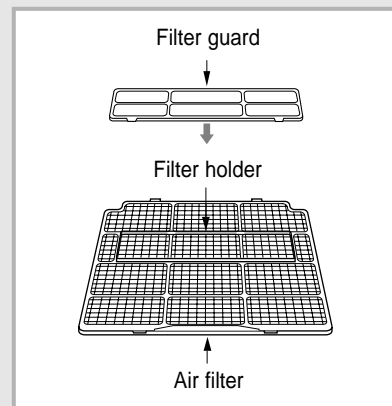

Technical Specifications

Design and specifications are subject to change without notice.

Model	Power Supply
AW127JE AW126JE WC12ZR	220-240V~, 50Hz
AW127JB AW126JB AW147JB AW146JB	220V~, 60Hz
AW12A6JD AW12A7JD	200-220V~, 50Hz
AW12A6JA AW12A7JA	115V~, 60Hz

Method of Installation

Before installation, be sure to check the installation area for the air conditioner, and installation method of the drain hose.

Checkpoints prior to installation

- 1 Check the cabinet and front grille of the unit for any harmful defects such as scratches.
- 2 Be sure to check the power supply.
- Refer to the specifications on the label attached to the unit.

Installation Conditions

- 1 As the unit is heavy, the wall or window of the installation area should have sufficient strength and durability for operation of the air conditioner, and for prevention of any vibration or noise.
If it is weak, reinforcement work should be performed separately.
- 2 It is advisable to install the air conditioner in the north or west side to prevent the effect of direct sunlight.
When installing it in the south or east side due to unavoidable circumstances, it is advisable to install the sunshade to prevent the direct sunlight.
In this case, take care not to cause any hindrance to the flow of outside air.
- 3 When installing the air conditioner, be sure to obtain sufficient space on the rear side of the unit for smooth flow of air.
When operating the air conditioner in closed areas such as inner building with cooling operation, and result in trouble with the unit.
See the illustration below.

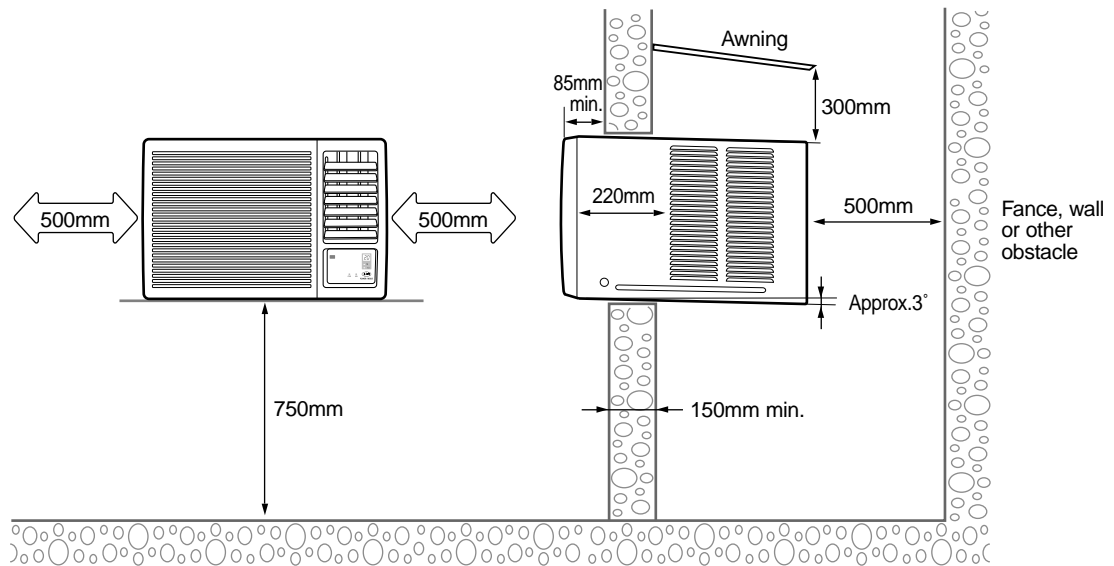

- ◆ If the wall is greater than 150mm thick, cut the wall back on a 45° angle if possible.

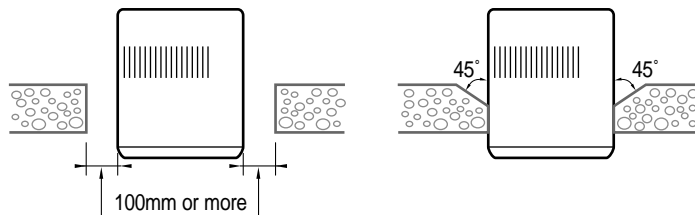

Installation of the Drain Tube

Fix the drain tube as shown in the figure.

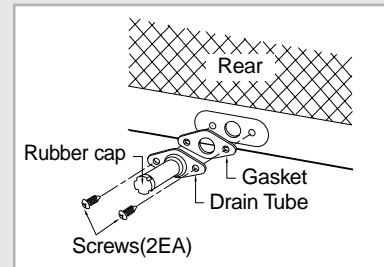



Installation of the Drain Pan

The procedure for installing the drain pan should be determined by the condition of the installing area.

◆ **In the case of an area where the drain pan can not be directly installed on the rear side of the unit after installing the air conditioner.**

Example: High storage

- 1 Open the front grille ; refer to page 13.
- 2 **Remove the screw located at the lower section of the front grille. It is secured in the  section depending on the model.**
- 3 Remove the front panel.
 - 3-1 Press both sides of the cabinet in the direction of the arrow as shown in the figure.
 - 3-2 Pull the lower part of the front panel slightly forward. (below three inches / 7cm)
 - 3-3 Lift the front panel upward.

 Applying excessive force to remove the front panel may cause damage to the tab ; be sure not to use excessive force.
- 4 Remove two screws on the lower, right and left sides of the unit.
- 5 Remove the chassis from the cabinet.
- 6 Remove the rubber cap inserted into the basepan.
- 7 Fix the drain pan as shown in the figure, and then connect the drain hose. (You can use any commercially-available drain hose.)
- 8 Install the cabinet at the specified area after installing the drain pan, and then re-assemble it in the original condition.
 - Secure the front panel to the case by replacing the screw removed in step 2. If a screw not removed in step 2, secure the panel with a supplied screw.

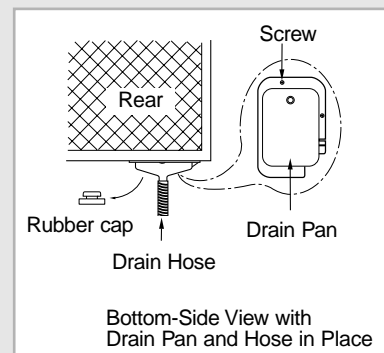
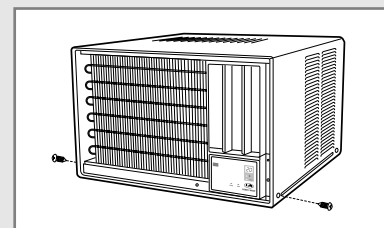
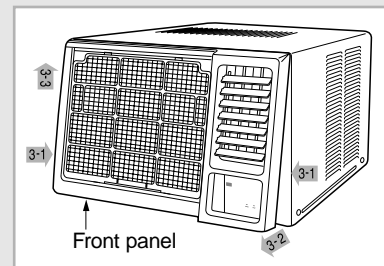
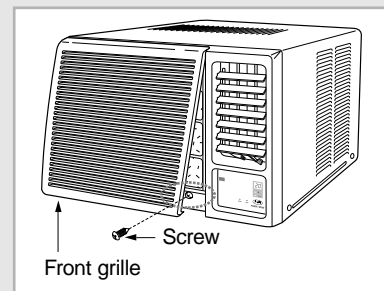

◆ **In the case of an area where the drain pan can be directly installed on the rear side of the unit after installing the air conditioner.**

- 1 Follow steps 6 and 7 only

**THIS AIR CONDITIONER IS MANUFACTURED BY:
ESTE AIRE ACONDICIONADO HA SIDO FABRICADO POR:
CE CLIMATISEUR EST FABRIQUE PAR:
ESTE APARELHO DE AR CONDICIONADO É FABRICADO POR:
QUESTO CONDIZIONATORE D'ARIA È PRODOTTO DA:**



ELECTRONICS