









Cisco Unified IP Conference Station 7937G Phone Guide for Cisco Unified Communications Manager 6.0

INCLUDING LICENSE AND WARRANTY

Americas Headquarters

Cisco Systems, Inc.
170 West Tasman Drive
San Jose, CA 95134-1706
USA
<http://www.cisco.com>
Tel: 408 526-4000
800 553-NETS (6387)
Fax: 408 527-0883

Common Phone Tasks

Place a call	Press  either before or after dialing a number.
Answer a call	Press  , or press the Answer softkey.
End a call	Press  , or press the EndCall softkey.
Redial a number	Press  , or press the Redial softkey.
Mute your phone	Press  .
Use call logs	Press  , select the desired call log, and then select the desired listing. To dial, highlight a listing, and then press Dial .
Hold/Resume a call	Press the Hold softkey to hold a call, or the Resume softkey to resume a call.
Transfer a call to a new number	Press the Transfer softkey, enter the number, and then press Transfer .
Start a standard (ad hoc) conference call	Press the Confrn softkey, dial the participant, and then press Confrn again.
Forward all calls	Press the CFwdALL softkey.



Cisco, Cisco Systems, the Cisco logo, and the Cisco Systems logo are registered trademarks or trademarks of Cisco Systems, Inc. and/or its affiliates in the United States and certain other countries. All other trademarks mentioned in this document or Website are the property of their respective owners. The use of the word partner does not imply a partnership relationship between Cisco and any other company. (0705R)

© 2009 Cisco Systems, Inc. All rights reserved.

OL-11559-02



QUICK REFERENCE



Cisco Unified IP Conference Station 7937G for Cisco Unified Communications Manager 6.0











Softkey Definitions
Phone Screen Icons
Button Icons
Common Phone Tasks

Softkey Definitions











AbbrDial	Dial using a Speed Dial index number
Answer	Answer any call ringing
<<	Delete entered characters
Barge	Add yourself to a call on a shared line
CallBack	Receive notification when a busy extension becomes available
cBarge	Add yourself to a call on a shared line and establish a conference
CFwdALL	Set up/cancel call forwarding
Clear	Delete records or settings
ConfList	View conference participants
Confrn	Create a conference call
Details	Receive information on all placed, received, or missed calls
Dial	Dial a phone number
DirTrfr	Transfer two calls to each other
Down	Decrease the display screen contrast settings
EditDial	Edit a number in a call log
EndCall	Disconnect the current call
Exit	Return to the previous screen
GPickUp	Answer a call ringing in another group
Hold	Place active call on hold
iDivert	Send or redirect a call to a voice message system

Join	Join other calls already on a line to create a conference
MeetMe	Host a Meet-Me conference
Message	Set up, check, or listen to voice messages
more	Display additional softkeys
New Call	Make a new call
Park	Park a call and display it
PickUp	Answer a call ringing in your group
Play	Hear a selected ring type
Redial	Redial the most recently dialed number
Resume	Resume a call on hold
Save	Save the chosen settings
Select	Choose a menu item or call
Submit	Confirm the UserID and PIN entered for Personal Directory access
Transfer	Transfer a call
Up	Increases the display screen contrast setting
Update	Refresh display screen content
Validate	Confirm the UserName and Password entered during security configuration
Voicemail	Check contents of voicemail

Phone Screen Icons

Line and Call States	
	Call on hold
	Connected call
	Incoming call
	Off-hook
	Shared line in use
Other Features	
	Checked box
	Locked
	Settings
	Unchecked box
	Unlocked

Button Icons

	Off-hook
	On-hook
	Navigation
	Select
	Applications
	Directories
	Redial
	Volume Up
	Volume Down
	Mute
	Softkeys

Contents

Getting Started 1

- Using this Guide 1
- Finding Additional Information 2
- Safety and Performance Information 2
- Cisco Product Security Overview 3
- Accessibility Features 3

Connecting Your Conference Station 4

- Connecting the Conference Station to the Network 4
- Registering with TAPS 7

An Overview of Your Conference Station 8

- Understanding Buttons and Hardware 8
- Understanding Lines vs. Calls 11
 - Understanding Line and Call Icons 11
- Understanding Display Screen Features 12
 - Choosing Menu Items 13
 - Cleaning and Maintaining the Display Screen 13
- Understanding Feature Buttons and Menus 13
- Understanding Feature Availability 14

Basic Call Handling 15

- Placing a Call—Basic Options 15
- Placing a Call—Additional Options 16
- Answering a Call 17
- Ending a Call 17
- Using Hold and Resume 17
- Using Mute 18
- Switching Between Multiple Calls 18
- Viewing Multiple Calls 18

Transferring Calls	19
Forwarding All Calls to Another Number	19
Making Conference Calls	20
Understanding Types of Conference Calls	20
Starting and Joining a Standard Conference	21
Starting or Joining a Meet-Me Conference Call	22

Advanced Call Handling 23

Speed Dialing	23
Picking Up a Redirected Call on Your Conference Station	24
Storing and Retrieving Parked Calls	25
Using a Shared Line	25
Understanding Shared Lines	25
Adding Yourself to a Shared-Line Call	26
Preventing Others from Viewing or Barging a Shared-Line Call	27
Tracing Suspicious Calls	27
Using Cisco Extension Mobility	28
Using AutoAnswer	28

Changing Conference Station Settings 29

Customizing Rings and Message Indicators	29
Customizing the Conference Station Display Screen	30

Using Call Logs and Directories 31

Using Call Logs	31
Directory Dialing	32
Using Corporate Directory on Your Conference Station	32
Using Personal Directory on Your Conference Station	33

Accessing Voice Messages 36

Using the User Options Web Pages 37

Accessing Your User Options Web Pages	37
Configuring Features and Services on the Web	37
Using Personal Directory on the Web	38

Using Your Personal Address Book on the Web	38
Configuring Fast Dials on the Web	39
Using the Address Book Synchronization Tool	40
Setting Up Speed Dialing on the Web	40
Setting Up Conference Station Services on the Web	41
Controlling User Settings on the Web	43
Controlling Line Settings on the Web	44
Using Cisco WebDialer	46
Understanding Additional Configuration Options	48
Troubleshooting Your Conference Station	50
General Troubleshooting	50
Viewing Conference Station Administration Data	51
Using the Quality Reporting Tool	51
Cisco One-Year Limited Hardware Warranty Terms	52
Index	55

Getting Started

Using this Guide

This guide provides you with an overview of the features available on your Cisco Unified IP Conference Station 7937G. You can read it completely for a solid understanding of your conference station's capabilities or refer to the table below for pointers to commonly used sections.

If you want to...	Then...
Review safety information	See Safety and Performance Information , page 2
Connect the conference station	See Connecting Your Conference Station , page 4
Use the conference station after it is installed	Start with An Overview of Your Conference Station , page 8
Learn what the conference station buttons mean	See Understanding Buttons and Hardware , page 8
Learn about the display screen	See Understanding Display Screen Features , page 12
Make calls	See Placing a Call—Basic Options , page 15
Put calls on hold	See Using Hold and Resume , page 17
Mute calls	See Using Mute , page 18
Transfer calls	See Transferring Calls , page 19
Make conference calls	See Making Conference Calls , page 20
Set up speed dialing	See Speed Dialing , page 23
Share a phone number	See Using a Shared Line , page 25
Change the ring volume or type	See Customizing Rings and Message Indicators , page 29
Change voice message indicators	See Customizing Rings and Message Indicators , page 29
View your missed calls	See Using Call Logs , page 31
Listen to your voice messages	See Accessing Voice Messages , page 36
See softkey and icon definitions	Refer to the Quick Reference Card in the front of this guide

Finding Additional Information

You can access the most current conference station documentation on the World Wide Web at this URL:

http://www.cisco.com/univercd/cc/td/doc/product/voice/c_ipphon/index.htm

You can access the Cisco website at this URL:

<http://www.cisco.com/>

You can access international Cisco websites from this URL:

http://www.cisco.com/public/countries_languages.shtml

Safety and Performance Information

Refer to these sections for information about the impact of power outages and other devices on your conference station.

Power Outage

Your accessibility to emergency service through the phone is dependent on the phone being powered. If there is an interruption in the power supply, Service and Emergency Calling Service dialing will not function until power is restored. In the case of a power failure or disruption, you may need to reset or reconfigure equipment before using the Service or Emergency Calling Service dialing.

Using External Devices

The following information applies when you use external devices with the conference station:

Cisco recommends the use of good quality external devices (such as headsets) that are shielded against unwanted radio frequency (RF) and audio frequency (AF) signals.

Depending on the quality of these devices and their proximity to other devices such as mobile phones or two-way radios, some audio noise may still occur. In these cases, Cisco recommends that you take one or more of the following actions:

- Move the external device away from the source of the RF or AF signals.
- Route the external device cables away from the source of the RF or AF signals.
- Use shielded cables for the external device, or use cables with a better shield and connector.
- Shorten the length of the external device cable.
- Apply ferrites or other such devices on the cables for the external device.

Cisco cannot guarantee the performance of the system because Cisco has no control over the quality of external devices, cables, and connectors. The system will perform adequately when suitable devices are attached using good quality cables and connectors.



Caution

In European Union countries, use only external speakers and microphones that are fully compliant with the EMC Directive [89/336/EC].

Cisco Product Security Overview

This product contains cryptographic features and is subject to United States and local country laws governing import, export, transfer and use. Delivery of Cisco cryptographic products does not imply third-party authority to import, export, distribute or use encryption. Importers, exporters, distributors and users are responsible for compliance with U.S. and local country laws. By using this product you agree to comply with applicable laws and regulations. If you are unable to comply with U.S. and local laws, return this product immediately.

A summary of U.S. laws governing Cisco cryptographic products may be found at: <http://www.cisco.com/wwl/export/crypto/tool/stqrg.html>. If you require further assistance please contact us by sending email to export@cisco.com.

Accessibility Features

A list of accessibility features is available upon request.

Connecting Your Conference Station

Your system administrator will likely connect your new Cisco Unified IP Conference Station 7937G to the corporate IP telephony network. If that is not the case, refer to the following graphics and tables to connect the conference station.

Connecting the Conference Station to the Network

The following graphic and table describe how to connect the conference station to the network.

 **Note** Connecting multiple conference stations is not a supported configuration and will not work.

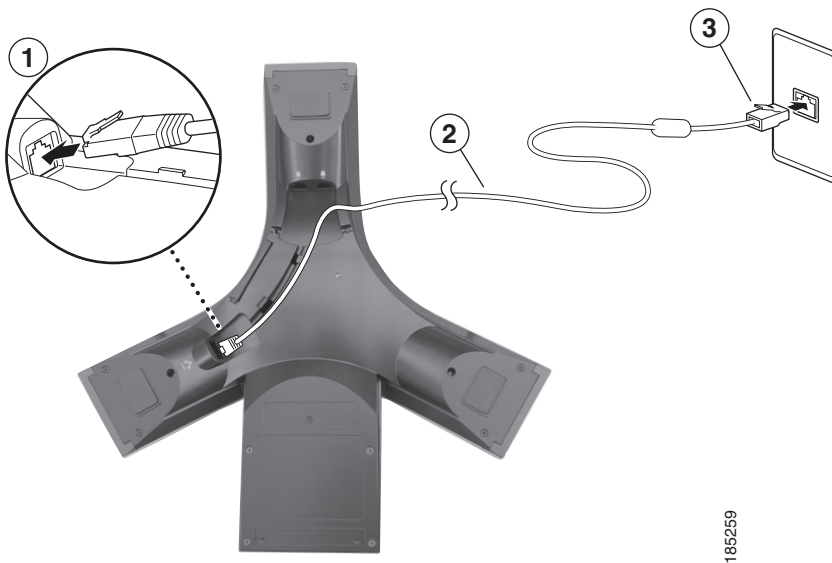

185259

1	Connection of end of network cable (without ferrite bead) to RJ-45 port on bottom of conference station
2	Network cable (25-foot)
3	Connection of end of network cable (with ferrite bead) to LAN port

Connecting Optional External Microphones

You can connect optional external microphones. See the graphic below.

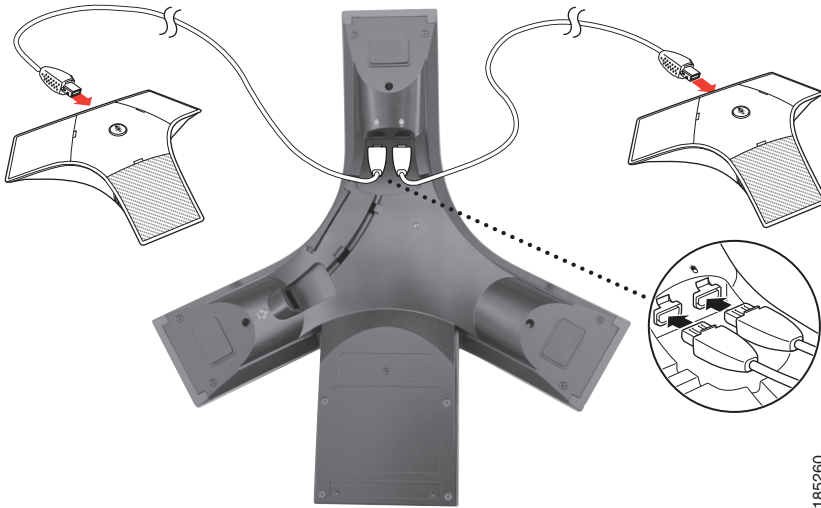

Connecting an Optional Third-Party Wireless Microphone Kit

You can connect an optional third-party wireless microphone kit. See the graphic below.

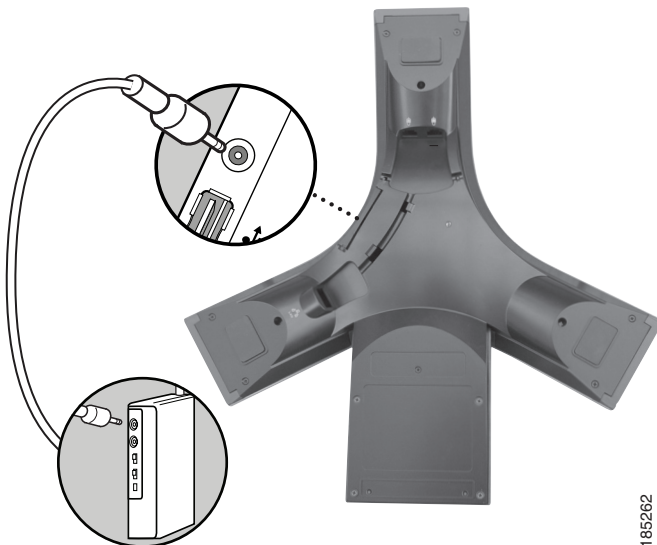

Connecting Conference Station Using an Optional External Power Source

If you connect the conference station to the network using an external power source, you must use a power interface cable and an external power supply. These items are optional and are not included in the conference station package. The following graphic and table show how to connect the conference station to the network if you use an external power source. For more information about using an external power source, see your system administrator.

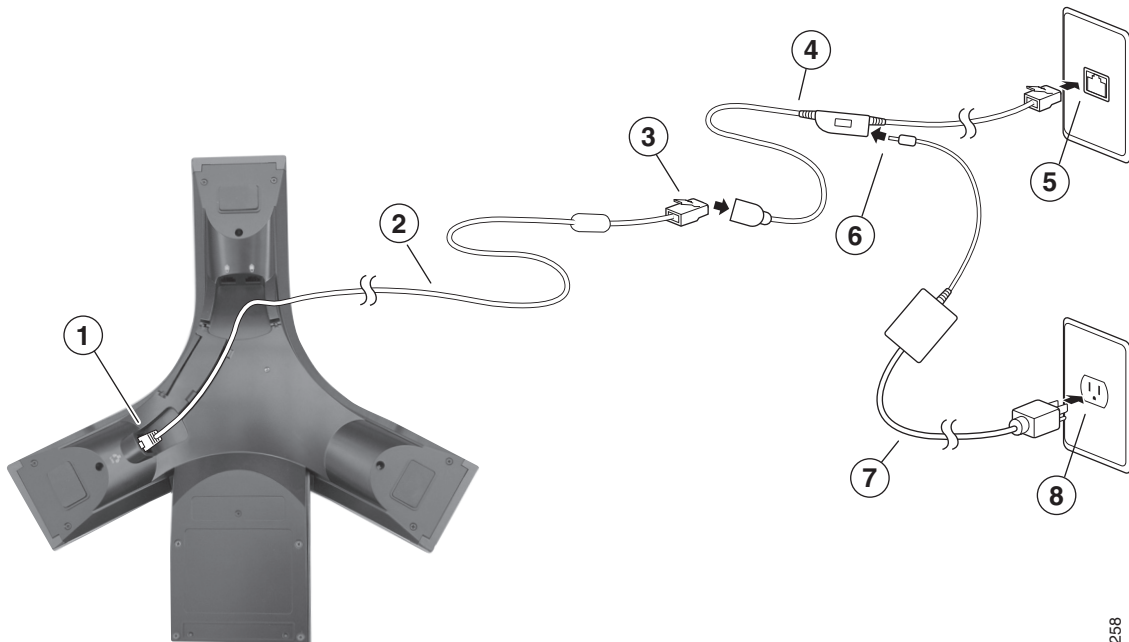

186258

1	Connection of end of network cable (without ferrite bead) to conference station RJ-45 port
2	Network cable (25-foot)
3	Connection of end of network cable (with ferrite bead) to power interface cable
4	Power interface cable
5	Connection of power interface cable to LAN wall port
6	Connection of power interface cable to external power supply
7	External power supply
8	Connection of external power supply to wall outlet

Registering with TAPS

After the conference station is connected to the network, your system administrator might ask you to auto-register the conference station using TAPS (Tool for Auto-Registered Phones Support). TAPS might be used either for a new conference station or to replace an existing conference station. To register with TAPS, activate the conference station, enter the TAPS extension provided by your system administrator, and follow the voice prompts. You might need to enter your entire extension, including the area code. After the conference station displays a confirmation message, hang up. The conference station will re-start.

An Overview of Your Conference Station

Your Cisco Unified IP Conference Station 7937G is a full-feature conference station that provides voice communication over the same data network that your computer uses. It allows you to place and receive calls, put calls on hold, transfer calls, make conference calls, and so on.





In addition to basic call-handling features, your conference station can provide enhanced productivity features that extend your call-handling capabilities. Depending on configuration, the conference station supports:



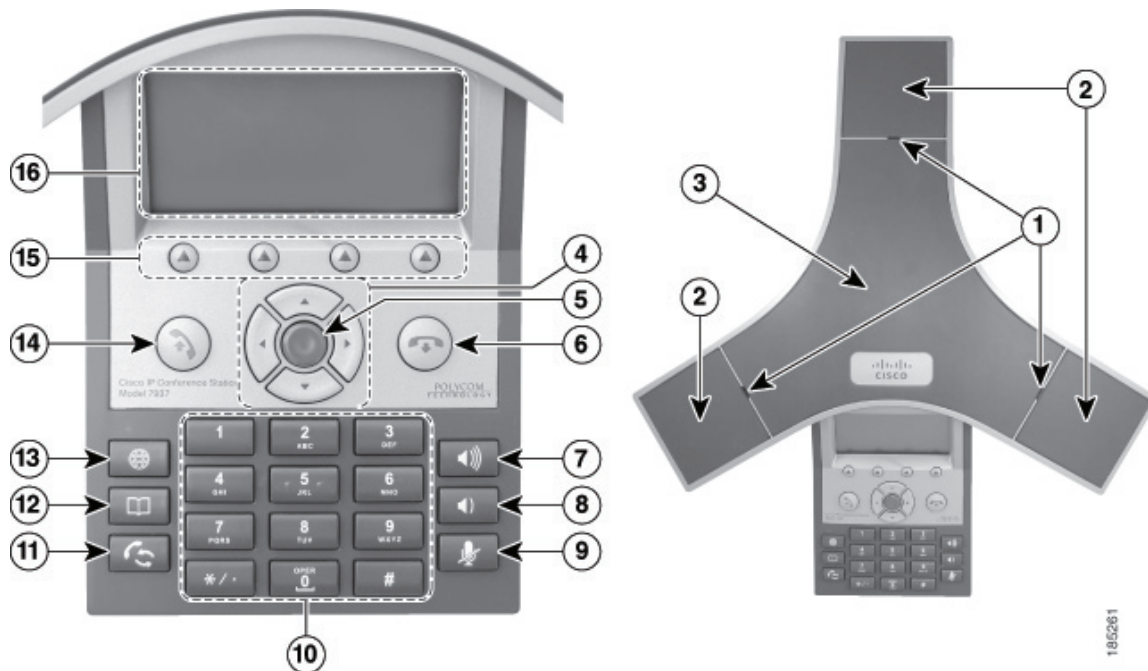

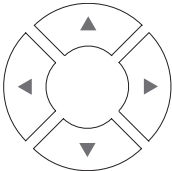

- Access to network data, XML applications, and web-based services.
- Online customizing of conference station features and services from your User Options web pages.

Understanding Buttons and Hardware

You can use the graphic and table below to identify buttons and hardware on your conference station.



	Item	Description	For more information, see...
1	LED indicators	<p>Three multi-color LED indicators provide call status information:</p> <ul style="list-style-type: none"> • Off: Ready, Call State Off • Solid amber: Powering On • Solid red: Powering On, Mute, or Voice Message • Flashing red: Hold • Solid green: Dial Tone, Dialing, or Connected • Flashing green: Incoming Call (Ringing/Connecting) 	<p><i>Cisco Unified IP Conference Station 7937G Administration Guide for Cisco Unified Communications Manager 6.0.</i></p>
2	Microphones	Three internal unidirectional microphones.	Your system administrator.
3	Speaker	Internal speaker.	Your system administrator.
4	Navigation buttons (four) 	Allow you to scroll through menus and highlight items.	Using Call Logs, page 31.
5	Select button 	Activates the currently highlighted screen menu option.	Choosing Menu Items, page 13.
6	On-hook button 	Ends your current call.	Placing a Call—Basic Options, page 15. Ending a Call, page 17 Transferring Calls, page 19
7	Volume Up button 	Raises the volume of the speaker (off-hook) and the ringer (on-hook).	Customizing Rings and Message Indicators, page 29.

	Item	Description	For more information, see...
8	Volume Down button 	Lowers the volume of the speaker (off-hook) and the ringer (on-hook).	Customizing Rings and Message Indicators, page 29.
9	Mute button 	Toggles the Mute feature.	Using Mute, page 18.
10	Keypad	Allows you to dial phone numbers, enter letters, and choose menu items.	Basic Call Handling, page 15.
11	Redial button 	Dials the most recent number you called.	Placing a Call—Basic Options, page 15.
12	Directories button 	Toggles the Directories menu. Allows you to access call logs, speed dials, and directories.	Using Call Logs and Directories, page 31. Advanced Call Handling, page 23.
13	Applications button 	Toggles the Applications menu. Allows you to access the Messages, Settings, and Services menus.	Accessing Voice Messages, page 36. Changing Conference Station Settings, page 29. Setting Up Conference Station Services on the Web, page 41.
14	Off-hook button 	Allows you to go off-hook to: <ul style="list-style-type: none"> • Invoke a dial tone • Obtain a dial tone to initiate a call • Initiate a call after you enter a phone number • Answer an incoming call • View certain softkeys 	Placing a Call—Basic Options, page 15. Starting or Joining a Meet-Me Conference Call, page 22 Picking Up a Redirected Call on Your Conference Station, page 24
15	Softkey buttons (four) 	Allow you to select softkey options that display on the screen.	Understanding Display Screen Features, page 12.
16	Conference station screen	Displays conference station menus and features.	Understanding Display Screen Features, page 12.





Understanding Lines vs. Calls

To avoid confusion about lines and calls, refer to these descriptions:

- **Line**—A line corresponds to the directory number that others can use to call you. Each conference station supports one line only. To see your conference station's line, look at the upper right of the display screen.
- **Call**—A line supports multiple calls. By default, the conference station supports four connected calls per line, but your system administrator can adjust this number according to your needs. Only one call can be active at any time; other calls are automatically placed on hold.

Understanding Line and Call Icons

The conference station displays icons to help you determine the line call state.

Icon	Line or call state	Description
	Off-hook line	You are dialing a number or an outgoing call is ringing.
	Connected call	You are currently connected to the other party.
	Ringing call	An incoming call is ringing on your line.
	Call on hold	You have put the call on hold. See Using Hold and Resume, page 17 .
	Remote-in-use	Another phone that shares your line has a connected call. See Using a Shared Line, page 25 .

Understanding Display Screen Features

You can use the following graphic and table to see what your conference station display screen looks like with active calls and feature menus open.

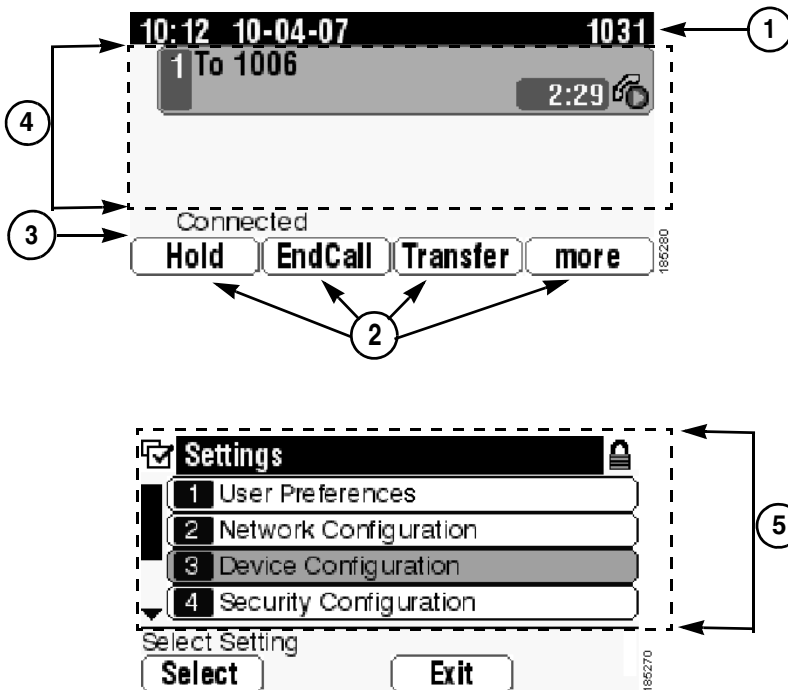

Item	Description
1	Conference station directory number Displays the current time, date, and number (directory number) of your conference station.
2	Softkey labels Each displays a softkey function. Softkey labels are selected by the softkey buttons.
3	Status line Displays conference station status information and prompts.
4	Call activity area Displays the current call, including caller ID, call duration, and call state. See Understanding Line and Call Icons, page 11 .
5	Feature menu Each indicates an open feature menu and the menu options. See Understanding Feature Buttons and Menus, page 13 .

Choosing Menu Items

There are three ways to choose menu items on the conference station's display screen.

To choose a display screen item...	Do this...
By softkey	Press the Select softkey.
By navigating (scrolling)	Press the appropriate Navigation button to highlight a desired menu item, and then press the Select button or the Select softkey.
By item number	Press the corresponding number on your keypad. For example, press 4 to choose the fourth item in a menu.

Cleaning and Maintaining the Display Screen





Caution

Use only a soft, dry cloth to wipe your conference station display screen. Do not use any liquids or powders on the phone, as they can contaminate phone components and cause failures.

Understanding Feature Buttons and Menus

Press a feature button to open or close a feature menu.

If you want to...	Then...
Open or close a menu	Press a feature button:  Applications (Messages, Settings, and Services).  Directories (Missed Calls, Placed Calls, Received Calls, Speed Dials, Personal Directory, Corporate Directory).
Scroll through a list or menu	Press the Up or Down Navigation button.
Go back one level in a feature menu	Press Exit . Pressing Exit from the top level of a menu closes the menu.

Understanding Feature Availability





Depending on the conference station system configuration, features included in this guide might not be available to you or might work differently on the conference station. Contact your support desk or system administrator for information about feature operation or availability.

Basic Call Handling

You can perform basic call-handling tasks using a range of features and services. Feature availability can vary; see your system administrator for more information.

Placing a Call—Basic Options

Here are some easy ways to place a call on your conference station.



If you want to...	Then...	For more information, see...
Place a call off-hook (with a dial tone)	Press  to go off-hook, and then enter a number.	Understanding Buttons and Hardware, page 8.
Place a call on-hook (without a dial tone), or pre-dial a number	Enter a number, and then go off-hook by pressing Dial or  .	Understanding Buttons and Hardware, page 8.
Redial a number	Press  to dial the last number. Or, press the Down Navigation button (with the conference station idle), highlight the desired phone number, and then press Dial .	Using Call Logs, page 31.
Place a call while another call is active	<ol style="list-style-type: none">1. Press Hold.2. Press New Call.3. Enter a number.	Using Hold and Resume, page 17.
Dial from a call log	<ol style="list-style-type: none">1. Choose  > Missed Calls, Placed Calls, or Received Calls.2. Select the desired listing from the call log, and then press Dial.	Using Call Logs, page 31.

Tip

- If you make a mistake while dialing, press << to erase digits.

Placing a Call—Additional Options

You can place calls using special features and services that might be available on the conference station. See your system administrator for more information about these additional options.

If you want to...	Then...	For more information, see...
Speed Dial a number	Do one of the following: <ul style="list-style-type: none"> • Choose  > Speed Dials. • Use the Abbreviated Dial feature. • Use the Fast Dial feature. 	Speed Dialing, page 23.
Dial from a corporate directory on the conference station	<ol style="list-style-type: none"> 1. Choose  > Corporate Directory (name can vary). 2. Enter a name and press Search. 3. Highlight a listing and press Dial. 	Using Corporate Directory on Your Conference Station, page 32.
Dial from a corporate directory on your personal computer using Cisco WebDialer	<ol style="list-style-type: none"> 1. Open a web browser and go to a WebDialer-enabled corporate directory. 2. Click the number that you want to dial. 	Using Cisco WebDialer, page 46.
Use Cisco CallBack to receive notification when a busy or ringing extension is available	<ol style="list-style-type: none"> 1. Press CallBack while listening to the busy tone or ring sound. 2. Hang up. The conference station alerts you when the line is free. 3. Place the call again. 	Your system administrator.
Dial from a Personal Address Book (PAB) entry	<ol style="list-style-type: none"> 1. Choose  > Personal Directory, and then log in with your Personal Directory UserID and PIN. 2. Choose Personal Address Book and search for a listing. 	Using Personal Directory on Your Conference Station, page 33.
Place a call using your Cisco Extension Mobility profile	Log in to Cisco Extension Mobility on a conference station.	Using Cisco Extension Mobility, page 28.

Answering a Call

You can answer a call by simply pressing the Off-hook button, or you can use other options if they are available on the conference station.

If you want to...	Then...	For more information, see...
Switch from a connected call to answer a new call	Press Answer	Using Hold and Resume, page 17
Answer a call on hold	Highlight the appropriate call, and then press Resume	Using Hold and Resume, page 17
Send a call to your voice messaging system	Press iDivert	Accessing Voice Messages, page 36
Auto-connect calls	Use AutoAnswer	Using AutoAnswer, page 28
Retrieve a parked call on another conference station	Use Call Park	Storing and Retrieving Parked Calls, page 25
Use the conference station to answer a call ringing elsewhere	Use Call Pickup	Picking Up a Redirected Call on Your Conference Station, page 24

Ending a Call

There are two ways to end a call.

If you want to...	Then...
Hang up your current call	Press  or EndCall .
Hang up one call, but preserve another call on the same line	Press EndCall . If necessary, remove the call from hold first.

Using Hold and Resume

You can hold and resume calls.



If you want to...	Then...
Put a call on hold	<ol style="list-style-type: none">1. Make sure the call you want to put on hold is highlighted.2. Press Hold.
Remove a call from hold	<ol style="list-style-type: none">1. Make sure the appropriate call is highlighted.2. Press Resume.

Tips

- Engaging the Hold feature typically generates music or a beeping tone.
- A held call is indicated by the Hold icon: 

Using Mute

With Mute enabled, you can hear other parties on a call but they cannot hear you. You can use Mute either in conjunction with the conference station or the external microphones.

If you want to...	Then...
Toggle Mute on	Press 
Toggle Mute off	Press 

Switching Between Multiple Calls

You can switch between multiple calls on a line. If the call that you want to switch to is not automatically highlighted, use the appropriate Navigation button to scroll to it.

If you want to...	Then...
Switch between connected calls on one line	<ol style="list-style-type: none">1. Make sure the call that you want to switch to is highlighted.2. Press Resume. Any active call is placed on hold and the selected call is resumed.
Switch from a connected call to answer a ringing call	Press Answer . The active call is placed on hold, and the selected call is resumed.

Viewing Multiple Calls

Understanding how multiple calls are displayed on the conference station can help you organize your call-handling efforts.

In standard viewing mode, the conference station displays calls as follows for the highlighted line:

- Calls with the highest precedence and longest duration display at the top of the list.
- Calls of a similar type are grouped together. For example, calls that you have interacted with are grouped near the top, and calls on hold are grouped last.

Transferring Calls

Transfer redirects a connected call. The *target* is the number to which you want to transfer the call.

If you want to...	Then...
Transfer a call without talking to the transfer recipient	<ol style="list-style-type: none">1. From an active call, press Transfer.2. Enter the target number.3. Press Transfer again to complete the transfer or EndCall to cancel. <p>Note If the conference station supports on-hook transfer, you can alternately complete the transfer by hanging up.</p>
Talk to the transfer recipient before transferring a call (consult transfer)	<ol style="list-style-type: none">1. From an active call, press Transfer.2. Enter the target number.3. Wait for the transfer recipient to answer.4. Press Transfer again to complete the transfer or EndCall to cancel. <p>Note If the conference station supports on-hook transfer, you can alternately complete the transfer by hanging up.</p>
Redirect a call to your voice messaging system	Press iDivert . The call is automatically transferred to your voice message greeting. You can use iDivert with a call that is in-progress, ringing, or on hold.

Tips

- If on-hook transfer is enabled on the conference station, you can either hang up to complete the call, or press **Transfer**, and then hang up.
- If on-hook transfer is not enabled on the conference station, hanging up without pressing **Transfer** again places the call on hold.
- You cannot use **Transfer** to redirect a call on hold. Press **Resume** to remove the call from hold before transferring it.

Forwarding All Calls to Another Number

You can redirect incoming calls from the conference station to another number.

If you want to...	Then...
Set up call forwarding on your conference station	Press CFwdAll and enter a target conference station number.
Cancel call forwarding on your conference station	Press CFwdAll .

If you want to...	Then...
Verify that call forwarding is enabled on your conference station	Look for the call forward target number in the status line.
Set up or cancel call forwarding remotely	<ol style="list-style-type: none"> <li data-bbox="440 297 1209 358">1. Log in to your User Options web pages. See Accessing Your User Options Web Pages, page 37. <li data-bbox="440 367 1143 427">2. Access your call forwarding settings. See Controlling Line Settings on the Web, page 44.

Tips

- Enter the call forward target number exactly as you would dial it from the conference station. For example, enter an access code or the area code, if necessary.
- You can forward your calls to a traditional analog telephone or to another IP conference station, although your system administrator might restrict the call forwarding feature to numbers within your company.
- Your system administrator can change call forwarding conditions for the conference station line.

Making Conference Calls

Your conference station allows you to combine three or more separate calls into one conversation, creating a conference call.

Understanding Types of Conference Calls

There are two types of conference calls: Standard and Meet-Me.

Standard Conference Calls

You can create a standard conference in different ways, depending on your needs and the softkeys available on the conference station:

- **Confrn**—Use this softkey to establish a standard conference by calling each participant. Standard conference calling is a default feature available on most conference stations.
- **cBarge**—Use this softkey to add yourself to an existing call on a shared line and to turn the call into a standard conference call. This feature is available only on conference stations that use a shared line.

For additional instructions, see [Starting and Joining a Standard Conference, page 21](#).

Meet-Me Conference Calls

You can create a Meet-Me conference by calling the Meet-Me conference station number at a specified time. For additional instructions, see [Starting or Joining a Meet-Me Conference Call, page 22](#).

Starting and Joining a Standard Conference

A standard conference allows at least three participants to talk on a single call.

If you want to...	Then...
<ul style="list-style-type: none">• Create a conference by calling participants• Add new participants to an existing conference	<ol style="list-style-type: none">1. From a connected call, press Confrn. (You may need to press the more softkey to see Confrn.)2. Enter the participant's conference station number.3. Wait for the call to connect.4. Press Confrn again to add the participant to your call.5. Repeat steps 1 to 4 to add additional participants.
Participate in a conference	Answer the conference station when it rings.
Create a conference by barging a call	Highlight a call on a shared line and press cBarge . (You may need to press the more softkey to see cBarge .) See Using a Shared Line, page 25 .
View a list of conference participants	<ol style="list-style-type: none">1. Highlight an active conference.2. Press ConfList. <p>Participants are listed in the order in which they join the conference with the most recent additions at the top.</p>
Get an updated list of participants	While viewing the conference list, press Update .
See who started the conference	While viewing the conference list, locate the person listed at the bottom of the list with an asterisk (*) next to the name.
Drop the last party added to the conference	Press RmLstC . You can remove participants only if you initiated the conference call.
Remove any conference participant	<ol style="list-style-type: none">1. Highlight the participant's name.2. Press Remove. <p>You can remove participants only if you initiated the conference.</p>
End your participation in a conference	Hang up or press EndCall .

Tip

- Depending on how the conference station is configured, if you leave a conference after creating it, the conference might end. To avoid this, transfer the conference before hanging up.

Starting or Joining a Meet-Me Conference Call

Meet-Me conferencing allows you to start or join a conference by dialing the conference number.

If you want to...	Then...
Start a Meet-Me conference	<ol style="list-style-type: none">1. Obtain a Meet-Me conference station number from your system administrator.2. Distribute the number to participants.3. When you are ready to start the meeting, go off-hook to invoke a dial tone, and then press MeetMe.4. Dial the Meet-Me conference number. Participants can now join the conference by dialing in. <p>Note Participants hear a busy tone if they call the conference before the initiator has joined. In this case, participants must call back.</p>
Join a Meet-Me conference	<p>Dial the Meet-Me conference number (provided by the conference initiator).</p> <p>Note You will hear a busy tone if you call the conference before the initiator has joined. In this case, try your call again.</p>
End a Meet-Me conference	<p>All participants must hang up.</p> <p>The conference does not automatically end when the conference initiator disconnects.</p>

Advanced Call Handling

Advanced call-handling tasks involve special features that your system administrator might configure for the Cisco Unified IP Conference Station 7937G depending on your call-handling needs and work environment.

Speed Dialing

Speed Dialing allows you to enter an index number or select a conference station screen item to place a call. Depending on configuration, the conference station can support several Speed Dialing features:

- Speed Dials
- Abbreviated Dials
- Fast Dials



Note

- To set up Speed Dials and Abbreviated Dials, access your User Options web pages. See [Accessing Your User Options Web Pages, page 37](#).
 - To set up Fast Dials, access the Personal Directory feature. See [Using Personal Directory on Your Conference Station, page 33](#).
 - Alternately, your system administrator can configure Speed Dialing features for you.
-

If you want to...	Then...
Use Speed Dials	<ol style="list-style-type: none">1. Set up Speed Dials. See Setting Up Speed Dialing on the Web, page 40.2. To place a Speed Dial call, press <input type="text"/> > Speed Dials, and then select the desired Speed Dial number.
Use Abbreviated Dials	<ol style="list-style-type: none">1. Set up Abbreviated Dialing codes. See Setting Up Speed Dialing on the Web, page 40.2. To place a call, enter the Abbreviated Dialing code and press AbbrDial.
Use Fast Dials	<ol style="list-style-type: none">1. Create a Personal Address Book entry and assign a Fast Dials code. See Using Personal Directory on Your Conference Station, page 33, or Using Personal Directory on the Web, page 38.2. To place a call, access the Fast Dial service on the conference station. See Using Personal Directory on Your Conference Station, page 33.

Picking Up a Redirected Call on Your Conference Station

Call PickUp allows you to answer a call that is ringing on a coworker's conference station by redirecting the call to your conference station. You might use Call PickUp if you share call-handling with coworkers.

If you want to...	Then...
Answer a call that is ringing on another extension within your call pickup group	<ol style="list-style-type: none">1. Do one of the following:<ul style="list-style-type: none">– If the PickUp softkey is available, press it.– If the PickUp softkey is not available, go off-hook to display it, and then press PickUp.If the conference station supports auto-pickup, you are now connected to the call.2. If the call rings, press Answer to connect to the call.
Answer a call that is ringing on another extension outside of your group	<ol style="list-style-type: none">1. Do one of the following:<ul style="list-style-type: none">– If the GPickUp softkey is available, press it.– If the GPickUp softkey is not available, go off-hook to display it, and then press GPickUp.2. Enter the group pickup code. If the conference station supports auto-pickup, you are now connected to the call.3. If the call rings, press Answer to connect to the call.
Answer a call that is ringing on another extension in your group or in an associated group	<ol style="list-style-type: none">1. Do one of the following:<ul style="list-style-type: none">– If the OPickUp softkey is available, press it.– If the OPickUp softkey is not available, go off-hook to display it, and then press OPickUp.If the conference station supports auto-pickup, you are now connected to the call.2. If the call rings, press Answer to connect to the call.

Tips

- Pressing **PickUp** and **GPickUp** connects you to the call that has been ringing for the longest time.
- Pressing **OPickUp** connects you to the call in the pickup group with the highest priority. Your system administrator sets the priority of pickup groups.

Storing and Retrieving Parked Calls

You can park a call when you want to store the call so that you or someone else can retrieve it from another conference station in the Cisco Unified Communications Manager system (for example, a conference station at a coworker's desk or in a conference).

If you want to...	Then...
Store an active call using Call Park	<ol style="list-style-type: none">1. During a call, press Park. (You may need to press the more softkey to see Park.)2. Note the call park number displayed on the conference station screen.3. Hang up.
Retrieve a parked call	Enter the call park number from any conference station in your network to connect to the call.



Note

You have a limited amount of time to retrieve a parked call before it reverts to ringing at the original number. For more information, see your system administrator.

Using a Shared Line

Your system administrator might ask you to use a shared line if you:

- Have multiple conference stations and want one conference station number
- Share call-handling tasks with coworkers
- Handle calls on behalf of a manager

Understanding Shared Lines

Remote-in-Use Icon

The remote-in-use icon  appears when another conference station that shares your line has a connected call. You can place and receive calls as usual on the shared line, even when the remote-in-use icon appears.

Sharing Call Information and Barging

Conference stations that share a line each display information about calls that are placed and received on the shared line. This information might include caller ID and call duration.

When call information is visible in this way, you and coworkers who share a line can add yourselves to calls using either **Barge** or **cBarge**. See [Adding Yourself to a Shared-Line Call, page 26](#).

Privacy

If you do not want coworkers who share your line to see information about your calls, enable the Privacy feature. The Privacy feature also prevents coworkers from barging your calls. See [Preventing Others from Viewing or Barging a Shared-Line Call](#), page 27.



Note The maximum number of calls that a shared line supports can vary by conference station.

Adding Yourself to a Shared-Line Call

Depending on how the conference station is configured, you can add yourself to a call on a shared line using either **Barge** or **cBarge**.



If you want to...	Then...
See if the shared line is in use	Look for a remote-in-use icon  on the lower left of the conference station display.
Add yourself to a call on a shared line using the Barge softkey	<ol style="list-style-type: none">1. Highlight a remote-in-use call.2. Press Barge. (You may need to press the more softkey to see Barge.) Other parties hear a beep tone announcing your presence.
Add yourself to a call on a shared line using the cBarge softkey	<ol style="list-style-type: none">1. Highlight a remote-in-use call.2. Press cBarge. (You may need to press the more softkey to see cBarge.) Other parties hear a tone and brief audio interruption, and call information changes on the conference station screen.
Add new conference participants to a call that you have barged	Barge the call using cBarge , if available. Unlike Barge , cBarge converts the call into a standard conference call, allowing you to add new participants. See Making Conference Calls , page 20.
Leave a barged call	Hang up. If you hang up after using Barge , the remaining parties hear a disconnect tone and the original call continues. If you hang up after using cBarge , the call remains a conference call (provided at least three participants remain on the line).

Tips

- If a conference station that is using the shared line has Privacy enabled, call information and barge softkeys will not appear on the other conference stations that share the line.
- You will be disconnected from a call that you have joined using **Barge** if the call is put on hold, transferred, or turned into a conference call.

Preventing Others from Viewing or Barging a Shared-Line Call

If you share a conference station line, you can use the Privacy feature to prevent others who share the line from viewing or barging (adding themselves to) your calls. Your system administrator must configure the Privacy feature for you.

If you want to...	Then...
Prevent others from viewing or barging calls on a shared line	<ol style="list-style-type: none">1. Press Private.2. To verify that Privacy is on, look for the feature-enabled icon  next to your directory number on the main display screen.
Allow others to view or barge calls on a shared line	<ol style="list-style-type: none">1. Press Private.2. To verify that Privacy is off, look for the feature-disabled icon  next to your directory number on the main display screen.

Tip

- If the conference station that shares your line has Privacy enabled, you can make and receive calls using the shared line as usual.



Tracing Suspicious Calls

If you receive suspicious or malicious calls, your system administrator can add the Malicious Call Identification (MCID) feature to your conference station. This feature enables you to identify an active call as suspicious, which initiates a series of automated tracking and notification messages.

If you want to...	Then...
Notify your system administrator about a suspicious or harassing call	Press MCID . Your conference station plays a tone and displays the message, "MCID successful."

Using Cisco Extension Mobility

Cisco Extension Mobility (EM) allows you to temporarily configure a conference station as your own. Once you log in to EM, the conference station adopts your user profile, including the conference station line, features, established services, and web-based settings. Your system administrator must configure EM for you.

If you want to...	Then...
Log on to EM	<ol style="list-style-type: none">1. Choose  > Services > EM Service (name can vary).2. Enter your userID and PIN (provided by your system administrator).3. If prompted, select a device profile.
Log off of EM	<ol style="list-style-type: none">1. Choose  > Services > EM Service (name can vary).2. When prompted to log out, press Yes.

Tips

- EM automatically logs you out after a certain amount of time. This time limit is established by your system administrator.
- Changes that you make to your EM profile (from your User Options web pages) take effect the next time that you log on to EM on a conference station.
- Settings that are controlled only on the conference station are not maintained in your EM profile.

Using AutoAnswer



When AutoAnswer is enabled, your conference station answers incoming calls automatically after a few rings. Your system administrator configures AutoAnswer to use the conference station. You might use AutoAnswer if you receive a high volume of incoming calls.

Changing Conference Station Settings

You can personalize your Cisco Unified IP Conference Station 7937G by adjusting the ring type and volume, the display screen, and voice message indicators.

Customizing Rings and Message Indicators

You can customize how the conference station indicates an incoming call and a new voice message. You can also adjust the ringer volume for the conference station.

If you want to...	Then...
Change the ring type	<ol style="list-style-type: none">1. Choose  > Settings > User Preferences > Ring Type.2. Highlight a ring type, and then press Play to hear a sample of it.3. Press Select, and then press Save to set the ring type.
Change how the conference station indicates a new voice mail message	<ol style="list-style-type: none">1. Log in to your User Options web pages. See Accessing Your User Options Web Pages, page 37.2. Access your message settings. See Controlling Line Settings on the Web, page 44. <p>Note Before you can access this setting, your system administrator might need to enable it for you.</p>
Adjust the volume level for the conference station ringer	Press  or  while the conference station is on-hook (that is, when there is no call activity). The volume is saved automatically.

Customizing the Conference Station Display Screen

You can adjust the characteristics of your conference station's display screen.





If you want to...	Then...
Change the display screen contrast	<ol style="list-style-type: none"><li data-bbox="370 300 1219 337">1. Choose  > Settings > User Preferences > Contrast.<li data-bbox="370 344 1219 381">2. To adjust the contrast settings, press Up or Down.<li data-bbox="370 388 1219 418">3. Press Save.
Change the language on the display screen	<ol style="list-style-type: none"><li data-bbox="370 425 1219 492">1. Log in to your User Options web pages. See Accessing Your User Options Web Pages, page 37.<li data-bbox="370 498 1219 557">2. Access your user settings. See Controlling User Settings on the Web, page 43.

Using Call Logs and Directories

This section describes how you can use call logs and directories on your Cisco Unified IP Conference Station 7937G. To access both features, use the Directories button .

Using Call Logs

Your conference station maintains call logs. Call logs contain records of your missed, placed, and received calls.

If you want to...	Then...
View your call logs	Choose  > Missed Calls , Placed Calls , or Received Calls . Each log stores up to 100 records. To view a truncated listing, highlight it and press EditDial .
Erase your call logs	Choose  , and then press Clear . This erases all records in all logs.
Dial from a call log (while not on another call)	<ol style="list-style-type: none">1. Choose  > Missed Calls, Placed Calls, or Received Calls.2. Highlight a call record from the log.3. Go off-hook to place the call.
Dial from a call log (while connected to another call)	<ol style="list-style-type: none">1. Choose  > Missed Calls, Placed Calls, or Received Calls.2. Highlight a call record from the log.3. Press Dial.4. Choose a menu item to handle the original call:<ul style="list-style-type: none">- Hold—Puts the first call on hold and dials the second.- Transfer—Transfers the first party to the second and drops you from the call. (Press Transfer again after dialing to complete the action.)- Conference—Creates a conference call with all parties, including you. (Press Confrn again after dialing to complete the action.)- EndCall—Disconnects the first call and dials the second.



Directory Dialing

Depending on configuration, the conference station can provide both corporate and personal directory features:

- **Corporate Directory**—Corporate contacts that you can access on the conference station. Corporate Directory is set up and maintained by your system administrator.
- **Personal Directory**—Personal contacts and associated fast dial codes that you configure and access from the conference station and your User Options web pages. Personal Directory contains the following menu items:
 - **Personal Address Book (PAB)**—A directory of your personal contacts.
 - **Fast Dials**—A quick-dialing method that allows you to assign PAB entries and conference station numbers to a fast dial list. For quick dialing, you search the list for the number to dial.

Using Corporate Directory on Your Conference Station

You can use a corporate directory to place calls to coworkers.

If you want to...	Then...
Dial from a corporate directory (while not on another call)	<ol style="list-style-type: none">1. Choose  > Corporate Directory (exact name can vary).2. Use your keypad to enter a full or partial name, and then press Search.3. To dial, press the listing, or scroll to the listing, and then go off-hook.
Dial from a corporate directory (while on another call)	<ol style="list-style-type: none">1. Choose  > Corporate Directory (exact name can vary).2. Use your keypad to enter a full or partial name, and then press Search.3. Scroll to a listing, and then press Dial.4. Choose a menu item to handle the original call:<ul style="list-style-type: none">– Hold—Puts the first call on hold and dials the second.– Transfer—Transfers the first party to the second and drops you from the call. (Press Transfer again after dialing to complete the action.)– Conference—Creates a conference call with all parties, including you. (Press Confmn again after dialing to complete the action.)– EndCall—Disconnects the first call and dials the second.

Tip

- Use the numbers on your keypad to enter characters on the conference station screen. Use the Navigation buttons on the conference station to move between input fields.

Using Personal Directory on Your Conference Station

The Personal Directory feature set contains your PAB and Fast Dials. This section describes how to set up and use Personal Directory on the conference station. To use Personal Directory on the web, see [Using Personal Directory on the Web, page 38](#).

If you want to...	Then...
Access Personal Directory (for PAB and Fast Dial codes)	<ol style="list-style-type: none"> 1. Choose  > Personal Directory (exact name can vary). 2. Enter your Personal Directory UserID and PIN, and then press Submit.
Search for a PAB entry	<ol style="list-style-type: none"> 1. Access Personal Directory, and then choose Personal Address Book. 2. Enter search criteria, and then press Submit. You can choose Previous or Next to move through listings. 3. Highlight the PAB entry that you want, and then press Select.
Dial from a PAB entry	<ol style="list-style-type: none"> 1. Search for a PAB entry. 2. Highlight the entry, and then press Select. 3. Press Dial. (You may need to press the more softkey to see Dial.) 4. Highlight the number that you want to dial, and then press OK. 5. Press OK again to dial the number.
Delete a PAB entry	<ol style="list-style-type: none"> 1. Search for a PAB entry. 2. Highlight the listing, and then press Select. 3. Press Delete. (You may need to press the more softkey to see Delete.) 4. Press OK to confirm the deletion.
Edit a PAB entry	<ol style="list-style-type: none"> 1. Search for a PAB entry. 2. Highlight the entry, and then press Select. 3. Press Edit to modify a name or email address. (You may need to press the more softkey to see Edit.) If necessary, choose Phones to modify a phone number. 4. Press Update.

If you want to...	Then...
Add a new PAB entry	<ol style="list-style-type: none"> 1. Access Personal Directory, and then choose Personal Address Book. 2. Press Submit. 3. Press New. (You may need to press the more softkey to see New.) 4. Use the conference station keypad to enter a name and email information. 5. Choose Phones, and then use the keypad to enter phone numbers. Be sure to include any necessary access codes such as a 9 or 1. 6. Press Submit to add the entry to the database.
Assign a Fast Dial code to a PAB entry	<ol style="list-style-type: none"> 1. Search for a PAB entry. 2. Highlight the entry, and then press Select. 3. Press Fast Dial. 4. Highlight the number that you want to add to the fast dial list, and then press Select. 5. Highlight a fast dial listing that is unassigned, and then press Select.
Add a new Fast Dial code (not using a PAB entry)	<ol style="list-style-type: none"> 1. Access Personal Directory, and then choose Personal Fast Dials. 2. Highlight a Fast Dial listing that is unassigned, and then press Select. (You may have to press the Next softkey to display an unassigned item.) 3. Press Assign. 4. Enter a phone number. 5. Press Update.
Search for Fast Dial codes	<ol style="list-style-type: none"> 1. Access Personal Directory, and then choose Personal Fast Dials. 2. Highlight the listing that you want, and then press Select. You can press Previous or Next to move through listings.
Place a call using a Fast Dial code	<ol style="list-style-type: none"> 1. Search for a fast dial listing. 2. Highlight the listing you want, and then press Select. 3. Press Dial. 4. Press OK to complete the action.
Delete a Fast Dial code	<ol style="list-style-type: none"> 1. Search for a fast dial listing. 2. Highlight the listing you want, and then press Select. 3. Press Remove.
Log out of Personal Directory	<ol style="list-style-type: none"> 1. From the Personal Directory menu, highlight Log Out, and then press Select. 2. Press OK.

Tips

- Your system administrator can provide you the userID and PIN that you need to log in to Personal Directory.
- Personal Directory automatically logs you out after a certain amount of time. This time limit can vary. Ask your system administrator for more information.
- Use the numbers on your keypad to enter characters on your conference station screen. Use the Navigation buttons on your conference station to move between input fields.

Accessing Voice Messages

To access voice messages, use the **Msgs** softkey.



Note Your company determines the voice message service that the Cisco Unified IP Conference Station 7937G system uses. For the most accurate and detailed information, refer to the documentation that came with your voice message service.

If you want to...	Then...
Set up and personalize your voice message service	Press the Msgs softkey, and then follow the Integrated Voice Response instructions. If a menu appears on your display screen, choose the appropriate menu item.
See if you have a new voice message	Look for these visual and audible alerts: <ul style="list-style-type: none">• Red LED indicators on the conference station• Stutter dial tone when you place a call To configure message indicators, see Customizing Rings and Message Indicators, page 29 .
Listen to your voice messages, or access the voice messages menu	Press the Msgs softkey. Depending on your voice message service, doing so either auto-dials the message service or provides a menu on your display screen.
Send a call to your voice message system	Press the iDivert softkey. The iDivert feature automatically transfers a call (including a ringing or held call) to your voice message system. Callers hear your voice message greeting and can leave you a message.

Using the User Options Web Pages

Your Cisco Unified IP Conference Station 7937G is a network device that can share information with other network devices in your company, including your personal computer. You can use your computer to log in to your User Options web pages, where you can control features, settings, and services for your conference station.

Accessing Your User Options Web Pages

This section describes how to log in and select a conference station.

If you want to...	Then do this...
Log in to your User Options web pages	<ol style="list-style-type: none"><li data-bbox="366 643 1264 703">1. Obtain a Cisco Unified Communications Manager User Options URL, username, and password from your system administrator.<li data-bbox="366 711 1264 906">2. Open a web browser on your computer, enter the URL, and then log in. If prompted to accept security settings, click Yes or Install Certificate. The Cisco Unified Communications Manager User Options main web page appears. From this page you can choose User Options to access Device Settings, User Settings, Directory features, a Personal Address Book, and Fast Dials.
Select a device after logging on	<ol style="list-style-type: none"><li data-bbox="366 922 1264 1019">1. Log in to your User Options web pages, and then choose User Options > Device. The Device Configuration page appears.<li data-bbox="366 1027 1264 1292">2. If you have multiple conference stations assigned to you, verify that the appropriate conference station is selected. If necessary, choose another conference station from the Name drop-down list. From the Device Configuration page, you can access conference station-specific options, such as Line Settings, Speed Dials, Phone Services, and Service URL. To return to the Device Configuration page from another page, choose User Options > Device.

Configuring Features and Services on the Web

This section describes how to configure features and services from your User Options web pages after logging in. To access your User Options web pages, see [Accessing Your User Options Web Pages, page 37](#).

Using Personal Directory on the Web

The Personal Directory feature set that you can access on your computer consists of:

- A Personal Address Book (PAB)
- Fast Dials
- Cisco Unified Communications Manager Address Book Synchronizer



Note You can also access PAB and Fast Dials from the conference station. See [Using Personal Directory on Your Conference Station, page 33](#).

Using Your Personal Address Book on the Web

This section describes how to use your PAB from your User Options web pages. To access your User Options web pages, see [Accessing Your User Options Web Pages, page 37](#).

If you want to...	Then do this after you log in...
Add a new PAB entry	<ol style="list-style-type: none">1. Choose User Options > Personal Address Book.2. Click Add New.3. Enter information for the entry.4. Click Save.
Search for a PAB entry	<ol style="list-style-type: none">1. Choose User Options > Personal Address Book.2. Specify search information, and then click Find.
Edit a PAB entry	<ol style="list-style-type: none">1. Choose User Options > Personal Address Book.2. Search for the PAB entry you want to edit.3. Click the nickname for the PAB entry you want to edit.4. Edit the entry, and then click Save.
Delete a PAB entry	<ol style="list-style-type: none">1. Choose User Options > Personal Address Book.2. Search for the PAB entry you want to delete.3. Check the checkbox next to the PAB entry you want to delete.4. Click Delete Selected.

Configuring Fast Dials on the Web

This section describes how to assign Fast Dials from your User Options web pages. To access your User Options web pages, see [Accessing Your User Options Web Pages](#), page 37.

If you want to...	Then do this after you log in...
Assign a Fast Dial code to a PAB entry	<ol style="list-style-type: none">1. Create a PAB entry to assign a fast dial to. For information on how to create a PAB entry, see the preceding section.2. Choose User Options > Fast Dials.3. Click Add New.4. In the Fast Dial Entry area, change the Fast Dial index number, if desired.5. Search for the PAB entry you created in step 1.6. In the search results area, click the phone number of the PAB entry. The phone number automatically appears in the Phone Number field.7. Click Save.
Assign a Fast Dial code to a conference station number (without using a PAB entry)	<ol style="list-style-type: none">1. Choose User Options > Fast Dials.2. Click Add New.3. In the Fast Dial Entry area, change the Fast Dial index number, if desired.4. In the Phone Number field, enter the phone number for the conference station.5. Click Save.
Search for a Fast Dial entry	<ol style="list-style-type: none">1. Choose User Options > Fast Dials.2. Specify search information, and then click Find.
Edit a Fast Dial conference station number	<ol style="list-style-type: none">1. Choose User Options > Fast Dials.2. Search for the fast dial entry that you want to edit.3. In the search results area, click a component of the fast dial entry.4. In the Phone Number field, change the phone number of the conference station.5. Click Save.
Delete a Fast Dial entry	<ol style="list-style-type: none">1. Choose User Options > Fast Dials.2. Search for the fast dial entry that you want to delete.3. Check the checkbox next to the fast dial entry you want to delete.4. Click Delete Selected.

Tips

- You can create up to 500 fast dial and PAB entries.
- When you create a new fast dial entry without using a PAB entry, the fast dial entry is labeled “Raw” in your User Options web pages. The entry does not display a configurable text label and does not have a matching entry in your PAB.

Using the Address Book Synchronization Tool

You can use the Cisco Unified Communications Manager Address Book Synchronizer to synchronize your existing Microsoft Windows Address Book (if applicable) with your PAB. Entries from your Microsoft Windows Address Book will then be accessible on your conference station and your User Options web pages. Your system administrator can give you access to the synchronizer and provide detailed installation instructions.

Setting Up Speed Dialing on the Web

Depending on configuration, the conference station can support several Speed Dialing features:

- Speed Dials
- Abbreviated Dials
- Fast Dials



Note

For more information on Speed Dialing features, see [Speed Dialing, page 23](#).

This section describes how to set up speed dialing features from your User Options web pages. To access your User Options web pages, see [Accessing Your User Options Web Pages, page 37](#).

If you want to...	Then do this after you log in...
Set up Speed Dials	<ol style="list-style-type: none"> 1. Choose User Options > Device. 2. If you have more than one device, select a device. 3. Click Speed Dials. 4. In the Speed Dial Settings area, enter a number and label for the speed dial entry. 5. Click Save. <p>Note The conference station uses the ASCII Label field if the conference station does not support double-byte character sets.</p>
Set up Abbreviated Dialing	<ol style="list-style-type: none"> 1. Choose User Options > Device. 2. If you have more than one device, select a device. 3. Click Speed Dials. 4. In the Abbreviated Dial Settings area, enter a number and label for the abbreviated-dial entry. 5. Click Save.
Set up Fast Dials	<p>See Configuring Fast Dials on the Web, page 39.</p> <p>You can also set up Fast Dials on the conference station. See Using Personal Directory on Your Conference Station, page 33.</p>

Setting Up Conference Station Services on the Web

Conference station services can include special conference station features, network data, and web-based information (such as stock quotes and movie listings). You must first subscribe to a conference station service before accessing it on the conference station.

This section describes how to configure conference station services using your User Options web pages. To access your User Options web pages, see [Accessing Your User Options Web Pages, page 37](#).

If you want to...	Then do this after you log in...
Subscribe to a service	<ol style="list-style-type: none"> 1. Choose User Options > Device. 2. If you have more than one device, select a device. 3. Click Phone Services. 4. Click Add New. 5. From the Select a Service drop-down list, select a service, and then click Next. 6. Click Save.
Search for services	<ol style="list-style-type: none"> 1. Choose User Options > Device. 2. If you have more than one device, select a device. 3. Click Phone Services. 4. Click Find.
End services	<ol style="list-style-type: none"> 1. Choose User Options > Device. 2. If you have more than one device, select a device. 3. Click Phone Services. 4. Click Find. 5. Check the checkboxes next to the services you want to end. 6. Click Delete Selected.
Change a service name	<ol style="list-style-type: none"> 1. Choose User Options > Device. 2. If you have more than one device, select a device. 3. Click Phone Services. 4. Click Find. 5. Click the name of the service you want to update. 6. Change the service information. 7. Click Save.
Access a service on the conference station	From the conference station, choose  > Services .

Controlling User Settings on the Web

User settings include your password, PIN, and language (locale) settings.

Your PIN and password allow you to access different features and services. For example, use your PIN to log in to Cisco Extension Mobility or Personal Directory on the conference station. Use your password to log in to your User Options web pages and Cisco WebDialer on your personal computer. For more information, ask your system administrator.

This section describes how to control your user settings from your User Options web pages. To access your User Options web pages, see [Accessing Your User Options Web Pages, page 37](#).

If you want to...	Then do this after you log in...
Change your password	<ol style="list-style-type: none">1. Choose User Options > User Settings.2. In the Browser Password area, enter your password information.3. Click Save.
Change your PIN	<ol style="list-style-type: none">1. Choose User Options > User Settings.2. In the Phone PIN area, enter your PIN information.3. Click Save.
Change the language (locale) for your User Options web pages	<ol style="list-style-type: none">1. Choose User Options > User Settings.2. In the User Locale area, choose the language for your web pages from the Locale drop-down list.3. Click Save.
Change the language (locale) for the conference station screen	<ol style="list-style-type: none">1. Choose User Options > Device.2. If you have more than one device, select the device that requires a language change.3. From the User Locale drop-down list, choose the language for the conference station screen.4. Click Save.

Controlling Line Settings on the Web

Line settings include call-forwarding, voice message indicators, ring types, and line text labels that you set up for your conference station.



- Note**
- You can set up call forwarding directly on the conference station. See [Forwarding All Calls to Another Number, page 19](#).
 - To learn about phone settings that you can access directly on the conference station, see [Changing Conference Station Settings, page 29](#).
 - By default, the ring type and line text label options do not display on your User Options web pages. See your system administrator to set up these options so you can access them.

This section describes the line settings you can update from your User Options web pages. To access your User Options web pages, see [Accessing Your User Options Web Pages, page 37](#).

If you want to...	Then do this after you log in...
Set up call forwarding	<ol style="list-style-type: none">1. Choose User Options > Device.2. If you have more than one device, select a device.3. Click Line Settings.4. In the Incoming Call Forwarding area, choose call forwarding settings for various conditions.5. Click Save.
Change the message indicator setting	<ol style="list-style-type: none">1. Choose User Options > Device.2. If you have more than one device, select a device.3. Click Line Settings.4. In the Message Waiting Lamp area, choose a policy from the Message Waiting Lamp Policy drop-down list. The policy tells the conference station how to indicate a new voice message. The conference station can display a light and/or a prompt (a message on the conference station screen). <p>Note Typically the System Policy prompts the conference station to display a steady red light to indicate a new voice message.</p> <ol style="list-style-type: none">5. Click Save.

If you want to...	Then do this after you log in...
Change the audible message indicator setting	<ol style="list-style-type: none"> 1. Choose User Options > Device. 2. If you have more than one device, select a device. 3. Click Line Settings. 4. In the Audible Message Waiting Indicator area, choose a policy from the Audible Message Waiting Indicator Policy drop-down list. If you turn the message indicator on, and you have a new voice message, you will hear a stutter dial tone when you place a call. 5. Click Save.
Change the ring type	<ol style="list-style-type: none"> 1. Choose User Options > Device. 2. If you have more than one device, select a device. 3. Click Line Settings. 4. In the Ring Settings area, choose a setting to tell the conference station how to indicate an incoming call. 5. Click Save. <p>Note The “idle” ring setting pertains if you receive an incoming call when the conference station is idle. The “consecutive” ring setting pertains if you receive an incoming call when the conference station is active.</p>
Update the text (line text label) that displays on the called party’s conference station that identifies your directory number.	<ol style="list-style-type: none"> 1. Choose User Options > Device. 2. If you have more than one device, select a device. 3. Click Line Settings. 4. In the Line Text Label area, enter the text that will identify your directory number when you call another conference station. <p>Note If you do not specify a line text label, your directory number will display on the called party’s conference station.</p> <ol style="list-style-type: none"> 5. Click Save. <p>Note The conference station uses the ASCII Label field if the conference station does not support double-byte character sets.</p>

Using Cisco WebDialer

Cisco WebDialer allows you to make calls on your conference station to directory contacts by clicking items in a web browser. Your system administrator must set up this feature for you.

If you want to...	Then...
Use Cisco WebDialer with your Cisco Unified Communications Manager User Options directory	<ol style="list-style-type: none"><li data-bbox="344 334 1210 393">1. Log in to your User Options web pages. See Accessing Your User Options Web Pages, page 37.<li data-bbox="344 399 1083 431">2. Choose User Options > Directory and search for a coworker.<li data-bbox="344 438 841 470">3. Click the number that you want to dial.<li data-bbox="344 477 1184 535">4. If this is your first time using Cisco WebDialer, set up preferences and click Submit. (See the last row in this table for details.)<li data-bbox="344 542 1204 659">5. If the Make Call page appears, click Dial. (See the last row in this table to learn how to suppress this page in the future, if desired.) The call is now placed on the conference station.<li data-bbox="344 665 1163 698">6. To end a call, click Hangup or hang up from the conference station.
Use Cisco WebDialer with another online corporate directory (not your Cisco Unified Communications Manager User Options directory)	<ol style="list-style-type: none"><li data-bbox="344 714 1204 773">1. Log in to a Cisco WebDialer-enabled corporate directory and search for coworkers.<li data-bbox="344 779 841 812">2. Click the number that you want to dial.<li data-bbox="344 818 969 850">3. When prompted, enter your user ID and password.<li data-bbox="344 857 1184 915">4. If this is your first time using Cisco WebDialer, set up preferences and click Submit. (See the last row in this table for details.)<li data-bbox="344 922 1204 1039">5. If the Make Call page appears, click Dial. (See the last row in this table to learn how to suppress this page in the future, if desired.) The call is now placed on the conference station.<li data-bbox="344 1045 1163 1078">6. To end a call, click Hangup or hang up from the conference station.

If you want to...	Then...
Log out of Cisco WebDialer	Click the logout icon in the Make Call or Hang Up page.
Set up, view, or change Cisco WebDialer preferences	<p>Access the Preferences page.</p> <p>The Preferences page appears the first time that you use Cisco WebDialer (after you click the number that you want to dial.)</p> <p>To return to Preferences in the future, click the Preferences icon from the Make Call or Hang Up page.</p> <p>The Preferences page contains the following options:</p> <ul style="list-style-type: none"> • Preferred language—Determines the language used for Cisco WebDialer settings and prompts. • Use permanent device—Identifies the conference station and directory number (line) that you will use to place Cisco WebDialer calls. • Use Extension Mobility—If selected, prompts Cisco WebDialer to use the conference station that is associated with your Cisco Extension Mobility profile (if available). • Do not display call confirmation—If selected, prompts Cisco WebDialer to suppress the Make Call page. This page appears by default after you click a conference station number in a Cisco WebDialer-enabled online directory. • Disable Auto Close—If selected, prompts Cisco WebDialer to display the Hang Up page.

Understanding Additional Configuration Options

Your system administrator can configure your Cisco Unified IP Conference Station 7937G to use specific button and softkey templates along with special services and features, if appropriate. This table provides an overview of some configuration options that you might want to discuss with your system administrator based on your calling needs and work environment.

If you...	Then...	For more information...
Need to handle more calls on the conference station line	Ask your system administrator to configure your line to support more calls.	Talk to your system administrator or phone support team.
Need more speed dial entries	First make sure that all your speed dial entries are assigned. If you need additional speed dials, try using abbreviated dials or fast dials.	See Speed Dialing, page 23 .
Want to use one extension for several phones	Request a shared line. This allows you, for example, to use one extension for your desk phone and lab phone.	See Using a Shared Line, page 25 .
Share conference stations or office space with coworkers	Consider using: <ul style="list-style-type: none">• Call Park to store and retrieve calls without using the transfer feature.• Call Pickup to answer calls ringing on another phone.• A shared line to view or join coworkers' calls.• Cisco Extension Mobility to apply the conference station number and user profile to a shared conference station.	Ask your system administrator about these features and see the following: <ul style="list-style-type: none">• Advanced Call Handling, page 23.• Using a Shared Line, page 25.• Tracing Suspicious Calls, page 27.• Using Cisco Extension Mobility, page 28.

If you...	Then...	For more information...
Answer calls frequently or handle calls on someone's behalf	Ask your system administrator to set up the AutoAnswer feature for the conference station.	See Using AutoAnswer, page 28 .
Want to temporarily apply the conference station number and settings to a shared conference station.	Ask your system administrator about the Cisco Extension Mobility Service.	See Using Cisco Extension Mobility, page 28 .

Troubleshooting Your Conference Station

This section provides troubleshooting information for the Cisco Unified IP Conference Station 7937G.



General Troubleshooting

This section provides information to help you troubleshoot general problems with the conference station. For more and detailed information, see your system administrator.

Symptom	Explanation
You cannot hear a dial tone or complete a call	One or more of the following factors might apply: <ul style="list-style-type: none">You must log into the Cisco Extension Mobility Service.The conference station has time-of-day restrictions that prevent you from using some features during certain hours of the day.
A conference station button is unresponsive	Your system administrator may have disabled the button on the conference station.
The softkey that you want to use does not appear	One or more of the following factors might apply: <ul style="list-style-type: none">You must change the line state (for example, go off-hook or have a connected call).You must press more to reveal additional softkeys.The conference station is not configured to support the feature associated with that softkey.
Barge fails and results in a fast busy tone	One or more of the following factors might apply: <ul style="list-style-type: none">You cannot barge an encrypted call if the conference station you are using is not configured for encryption. When your barge attempt fails for this reason, the conference station plays a fast busy tone.You have toggled on the Privacy softkey.
You are disconnected from a call that you joined using Barge	You will be disconnected from a call that you have joined using Barge if the call is put on hold, transferred, or turned into a conference call.
Cisco CallBack fails	The other party might have call forwarding enabled.

Viewing Conference Station Administration Data

Your system administrator might ask you to access administration data on the conference station for troubleshooting purposes.

If you are asked to...	Then...
Access network configuration data	Choose  > Settings > Network Configuration , and then navigate to the item that you want to view.
Access status data	Choose  > Settings > Status , and then navigate to the item that you want to view.
Access conference station model information	Choose  > Settings > Model Information , and then navigate to the item that you want to view.

Using the Quality Reporting Tool

Your system administrator may temporarily configure the conference station with the Quality Reporting Tool (QRT) to troubleshoot performance problems. You can press **QRT** to submit information to your system administrator. Depending on your configuration, use the QRT to:

- Immediately report an audio problem on a current call.
- Select a general problem from a list of categories and choose reason codes.

Cisco One-Year Limited Hardware Warranty Terms

There are special terms applicable to your hardware warranty and various services that you can use during the warranty period. Your formal Warranty Statement, including the warranties and license agreements applicable to Cisco software, is available on Cisco.com. Follow these steps to access and download the Cisco Information Packet and your warranty and license agreements from Cisco.com.

1. Launch your browser, and go to this URL:

http://www.cisco.com/univercd/cc/td/doc/es_inpkc/cetrans.htm

The Warranties and License Agreements page appears.

2. To read the *Cisco Information Packet*, follow these steps:

- a. Click the **Information Packet Number** field, and make sure that the part number 78-5235-03B0 is highlighted.
- b. Select the language in which you would like to read the document.
- c. Click **Go**.

The Cisco Limited Warranty and Software License page from the Information Packet appears.

- d. Read the document online, or click the **PDF** icon to download and print the document in Adobe Portable Document Format (PDF).



Note

You must have Adobe Acrobat Reader to view and print PDF files. You can download the reader from Adobe's website: <http://www.adobe.com>

3. To read translated and localized warranty information about your product, follow these steps:

- a. Enter this part number in the Warranty Document Number field:
78-10747-01C0
- b. Select the language in which you would like to view the document.
- c. Click **Go**.

The Cisco warranty page appears.

- d. Read the document online, or click the **PDF** icon to download and print the document in Adobe Portable Document Format (PDF).

You can also contact the Cisco service and support website for assistance:

http://www.cisco.com/public/Support_root.shtml.

Duration of Hardware Warranty

One (1) Year

Replacement, Repair, or Refund Policy for Hardware

Cisco or its service center will use commercially reasonable efforts to ship a replacement part within ten (10) working days after receipt of a Return Materials Authorization (RMA) request. Actual delivery times can vary, depending on the customer location.

Cisco reserves the right to refund the purchase price as its exclusive warranty remedy.

To Receive a Return Materials Authorization (RMA) Number

Contact the company from whom you purchased the product. If you purchased the product directly from Cisco, contact your Cisco Sales and Service Representative.

Complete the information below, and keep it for reference.

Company product purchased from	
Company telephone number	
Product model number	
Product serial number	
Maintenance contract number	

Index

A

abbreviated dials

about [23](#)

setting up [40–41](#)

using [23](#)

Address Book Synchronizer [40](#)

administration data, viewing [51](#)

answering calls [17](#)

applications button, about [10](#)

ASCII label field support [41](#)

AutoAnswer [28](#)

B

barge

and privacy [27](#)

and shared lines [25–27](#)

using [26](#)

buttons, identifying [8–10](#)

C

call

forwarding, setting up from conference station [19–20](#)

forwarding, setting up from web [20, 44](#)

logs [15, 31](#)

park [25](#)

PickUp [24](#)

CallBack [16](#)

caller ID [12](#)

call-handling [15–22, 23–28](#)

calls

answering [17](#)

barging [25](#)

and call forwarding [19–20, 44](#)

compared to lines [11](#)

conference [20–22](#)

ending [17](#)

holding and resuming [17](#)

icons for [11](#)

maximum per line [11](#)

multiple parties on [20](#)

multiple, handling and viewing [18](#)

muting [18](#)

on hold, answering [17](#)

parked, storing and retrieving [25](#)

placing [15–16](#)

preventing barging of [27](#)

redirecting while ringing [17, 24](#)

removing from hold [17](#)

reporting problems with [51](#)

sending to voice messaging system [17](#)

shared lines [25–27](#)

- suspicious [27](#)
- transferring [19](#)
- cBarge
 - about [20](#)
 - using [26](#)
 - See also* barge
- Cisco Extension Mobility [16, 28](#)
- Cisco Unified Communications Manager
 - Address Book Synchronizer [40](#)
 - User Options web pages [37–47](#)
- Cisco Unified IP Conference Station 7937G.
 - See* conference station
- Cisco WebDialer, using [16, 46–47](#)
- conference calls [20–22](#)
- conference station
 - buttons [8–10](#)
 - cleaning [13](#)
 - connecting to network [4](#)
 - connecting to power interface cable [5–6](#)
 - connections, illustrations of [4–6](#)
 - documentation for [2](#)
 - feature configuration for [14, 48](#)
 - illustration of [8](#)
 - installing [4–6](#)
 - lines, description of [11](#)
 - microphones, using [5](#)
 - overview of [8–14](#)
 - registering [7](#)
 - ringer, adjusting volume [29](#)
 - services [41–42](#)
 - sharing [48](#)
 - troubleshooting [50–51](#)
 - using with external power source [5–6](#)

- voicemail settings, adjusting [29](#)
- wireless microphone, using [5](#)
- corporate directory [16, 32, 46](#)

D

- dialing, options for [15–16](#)
- directories
 - about [32](#)
 - button [10](#)
 - corporate [16, 32, 46](#)
 - personal [32–34](#)
 - using from conference station [32–34](#)
 - using from web [38–40](#)
- documentation, accessing [2](#)

E

- EM [16, 28](#)
- ending a call, options for [17](#)
- erasing call logs [31](#)
- Extension Mobility [16, 28](#)
- external microphones, graphic [5](#)
- external power source
 - about [6](#)
 - illustration of [6](#)
 - using [5–6](#)

F

- fast dials
 - about [23, 32, 33](#)
 - setting up [39, 40–41](#)
 - using [23, 33, 34](#)

feature menus [13](#)
features, availability of [14, 48](#)
forwarding calls [19–20, 44](#)

G

going off-hook [15](#)
GPickUp [24](#)

H

hanging up, options for [17](#)
headset, hanging up with [17](#)
hold
 and switching calls [18](#)
 and transferring [19](#)
 using [17](#)

I

icons
 for call states [11](#)
 for lines [11](#)
iDivert [19, 36](#)
installing the conference station [4–7](#)

L

language settings, changing [30, 43](#)
LED indicators, about [9](#)
lines
 and call forwarding [19, 44](#)
 call states for [11](#)

 compared to calls [11](#)
 description of [11](#)
 icons for [11](#)
 number of calls supported on [11, 48](#)
 ring types for [29](#)
 shared [25](#)
 voice message settings for [44–45](#)

M

Malicious Call Identification [27](#)
MCID [27](#)
Meet-Me conferences [21, 22](#)
menus, using [13](#)
message indicators, setting up [29, 44](#)
messages, listening to [36](#)
microphones, graphic [5](#)
missed calls, viewing [31](#)
model information, viewing [51](#)
multiple calls, handling [18](#)
mute [10, 18](#)

N

navigation buttons, about [9](#)
network cable, connecting [4](#)
network configuration data, viewing [50](#)

O

off-hook, about [15](#)
on-hook, about [15](#)
OPickUp [24](#)

P

PAB

- about [32](#)
- accessing [33](#)
- using from conference station [16, 33–34](#)
- using from web page [38–39](#)

Park [25](#)

parked call, retrieving [17, 25](#)

password, changing [43](#)

Personal Address Book. *See* PAB

personal directory

- about [32](#)
- using from web page [38–40](#)
- using on conference station [33–34](#)

PickUp [24](#)

PIN, changing [43](#)

placed calls, viewing [31](#)

placing calls, options for [15, 16](#)

power

- external
 - about [6](#)
 - illustration of [6](#)
- interface cable
 - about [6](#)
 - illustration of [6](#)
- supply, interruption of [2](#)

pre-dial [15](#)

privacy, and shared lines [25, 27](#)

Q

QRT [51](#)

Quality Reporting Tool [51](#)

R

received calls, viewing [31](#)

redialing a number [10, 15](#)

redirecting calls [24](#)

remote-in-use icon for shared lines [25](#)

resume, using [17](#)

ringer, adjusting [29](#)

S

safety warnings [2](#)

screen, adjusting contrast [30](#)

select button, about [9](#)

services [41–42](#)

shared lines

- and remote-in-use icon [25](#)
- description of [25](#)
- with barge [26–27](#)
- with privacy [27](#)

sharing conference stations [48](#)

softkeys, about [10, 12](#)

speakerphone, using [15, 17](#)

speed dials

- about [23](#)
- setting up [40–41](#)
- using [16, 23](#)

status data, viewing [50](#)

subscriptions, for conference station services [41](#)

suspicious calls, handling [27](#)

switching calls [18](#)

T

TAPS [7](#)

Tool for Auto-Registered Phones Support [7](#)

transferring calls [19](#)

troubleshooting

 general [50](#)

See also QRT

U

User Options web pages [37–47](#)

V

voice mail settings, changing [29, 44–45](#)

volume, adjusting for ringer [29](#)

W

warnings, safety [2](#)

web-based services, setting up [37](#)

WebDialer, using [16, 46–47](#)

wireless microphone kit, graphic [5](#)



Americas Headquarters
Cisco Systems, Inc.
San Jose, CA

Asia Pacific Headquarters
Cisco Systems (USA) Pte. Ltd.
Singapore

Europe Headquarters
Cisco Systems International BV
Amsterdam, The Netherlands

Cisco has more than 200 offices worldwide. Addresses, phone numbers, and fax numbers are listed on the
Cisco Website at www.cisco.com/go/offices.

CCDE, CCENT, Cisco Eos, Cisco Lumin, Cisco Nexus, Cisco StadiumVision, Cisco TelePresence, the Cisco logo, DCE, and Welcome to the Human Network are trademarks; Changing the Way We Work, Live, Play, and Learn and Cisco Store are service marks; and Access Registrar, Aironet, AsyncOS, Bringing the Meeting To You, Catalyst, CCDA, CCDP, CCIE, CCIP, CCNA, CCNP, CCSP, CCVP, Cisco, the Cisco Certified Internetwork Expert logo, Cisco IOS, Cisco Press, Cisco Systems, Cisco Systems Capital, the Cisco Systems logo, Cisco Unity, Collaboration Without Limitation, EtherFast, EtherSwitch, Event Center, Fast Step, Follow Me Browsing, FormShare, GigaDrive, HomeLink, Internet Quotient, IOS, iPhone, iQ Expertise, the iQ logo, iQ Net Readiness Scorecard, iQuick Study, IronPort, the IronPort logo, LightStream, Linksys, MediaTone, MeetingPlace, MeetingPlace Chime Sound, MGX, Networkers, Networking Academy, Network Registrar, PCNow, PIX, PowerPanels, ProConnect, ScriptShare, SenderBase, SMARTnet, Spectrum Expert, StackWise, The Fastest Way to Increase Your Internet Quotient, TransPath, WebEx, and the WebEx logo are registered trademarks of Cisco Systems, Inc. and/or its affiliates in the United States and certain other countries.

All other trademarks mentioned in this document or Website are the property of their respective owners. The use of the word partner does not imply a partnership relationship between Cisco and any other company. (0807R)

© 2009 Cisco Systems, Inc. All rights reserved.



The Java logo is a trademark or registered trademark of Sun Microsystems, Inc. in the U.S. or other countries.