

# **READ ME FIRST**

# **Windows® NT**



---

## **\*DSL Equipment Installation Guide: Alcatel Speed Touch PC®**

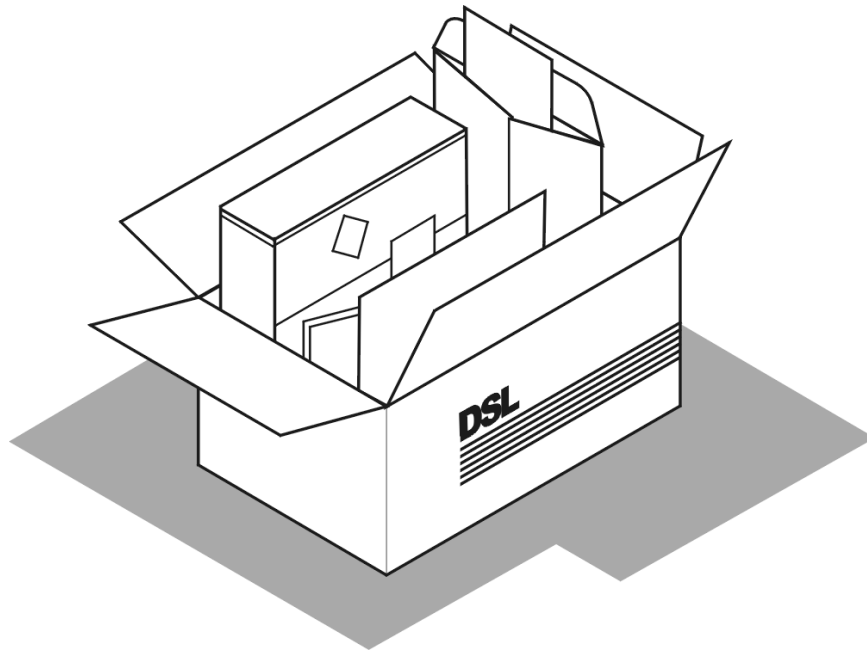

---

**\*Digital Subscriber Line**

Part Number: AlcatelPCNT02A  
Version 1.2-A

©2001 SBC Advanced Solutions, Inc. All rights reserved.

# Table of Contents

---

## Follow Steps 1 through 7 to complete the DSL Equipment Installation

---

Step 1: Verify Your System Requirements and Documents	2
Step 2: Verify the Contents of Your DSL Equipment Kit	3
Step 3: Install a Telephone Filter on Every Telephone Line	4
Step 4: Choose Your Modem and Check Your Minimum Requirements	8
Step 5: Installing the Alcatel Speed Touch PC® Software and Hardware	12
Step 6: Finish Configuring your System	19
Step 7: Create a Connection Profile	22
APPENDICES	24
Having Trouble?	25
Uninstalling/Reinstalling the Alcatel Speed Touch PC® Adapter	26
Adding TCP/IP to Windows NT	27
Troubleshooting SBC Express	30
Modem Diagnostic Lights	32

For Support:

- Review the **troubleshooting section** in this guide on **page 25**
- Call your Internet Service Provider 'help desk' for further information on Internet Service Provider connection, and registration.

**IMPORTANT NOTE: This guide portrays the typical flow for the installation process. Please follow the instructions, including running the SBC Express software BEFORE installing any NIC cards or modems. Some computer or network configurations may cause software windows to appear that are not depicted in this guide. Please read and follow the instructions on those screens to continue the installation process.**

**Verify that you are installing your DSL equipment AFTER the “Service Completion Date” given to you when you ordered your DSL Internet Service.**

**SBC Advanced Solutions, Inc. and affiliates have no responsibility for any personal injury or property damage which may result from your installation of DSL Equipment as discussed in this Guide. SBC Advanced Solutions, Inc. and its affiliates specifically disclaim any liability for such injury or damage. By proceeding with this installation, you assume all risk of personal injury or property damage. Please consult the documentation provided by your PC vendor to identify any impacts to your warranty. SBC, SBC EXPRESS and the SBC Logo are registered trademarks of SBC Communications, Inc.**

## ***Step 1*: Verify Your System Requirements and Documents**

---

**This Installation Guide is for Windows® NT users only.**

**The SBC Express software will ensure that you meet the following minimum requirements. You will not be able to complete the installation without meeting these requirements.**

- PC with a Pentium-class processor, CD-ROM Drive, 133 MHz, 25 Mb free disk space, 32 Mb RAM and An available PCI slot

**Other items you may need during the installation process:**

- Your system manufacturer Owner's Manual.
- Documentation and/or software from your Internet Service Provider.

**Call your Internet Service Provider if you have questions regarding System Requirements or System Documentation.**

## Step 2: Verify the Contents of Your DSL Equipment Kit

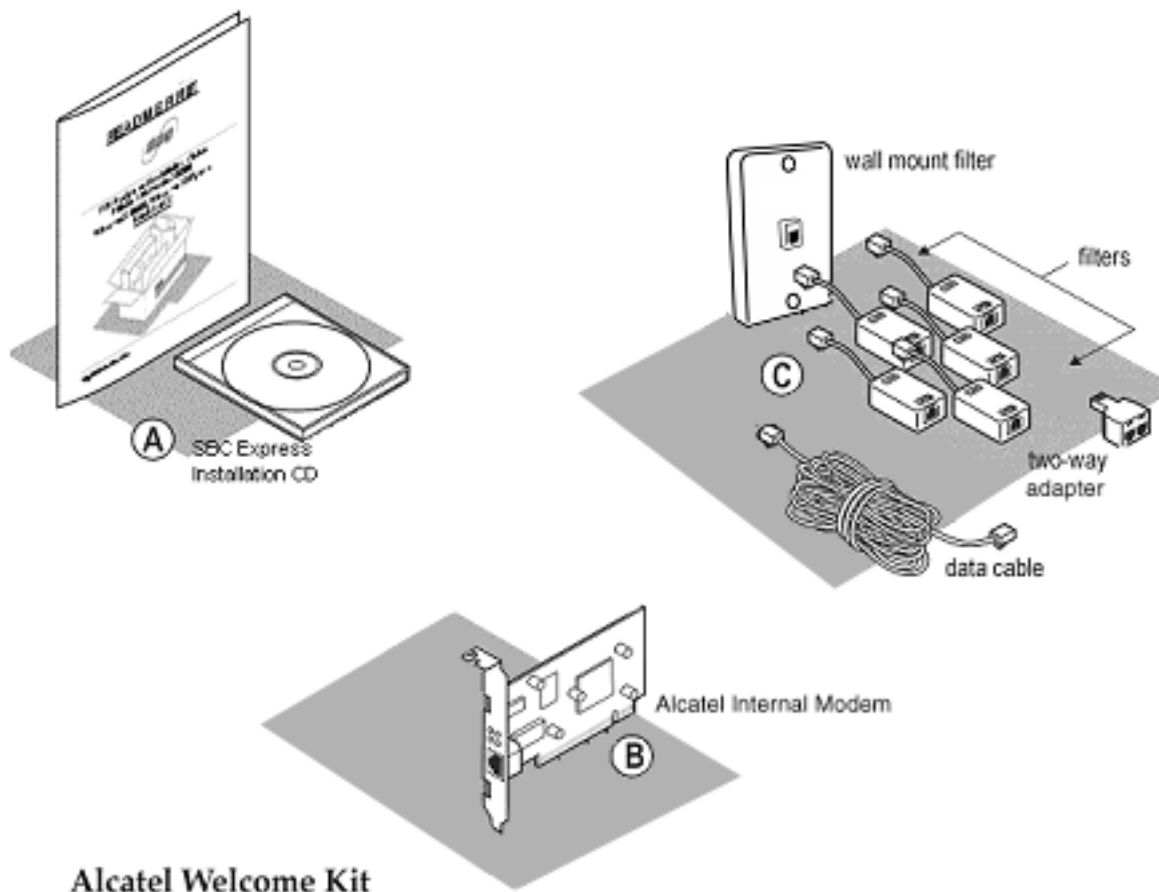

### Your DSL Equipment Kit Contains:

**A:** This Installation Guide and the SBC Express CD.

**B:** 1 Alcatel Speed Touch PC® Internal Modem

**C:** 1 Filter Pack containing: 5 in-line filters, 1 wall-mount filter, 1 two-way adapter, and 1 data cable.

*Note: Internet Software and/or instructions may be provided separately by your Internet Service Provider.*

## **Step 3: Install a Telephone Filter on Every Telephone Line**

3-1 Determine how many telephone jacks in your home share the same telephone number with the activated DSL.

**1) Locate the phone jack where you want to connect your DSL**

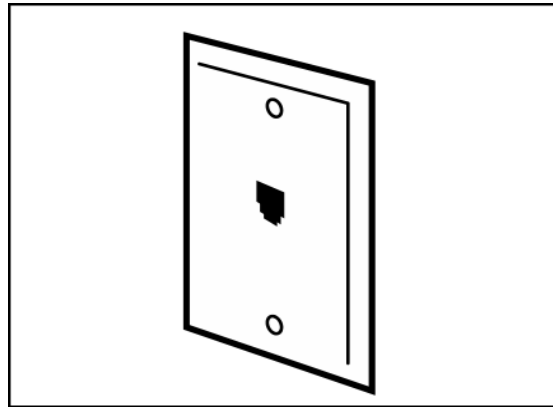

**2) Insert the 2-way adapter in the phone jack**

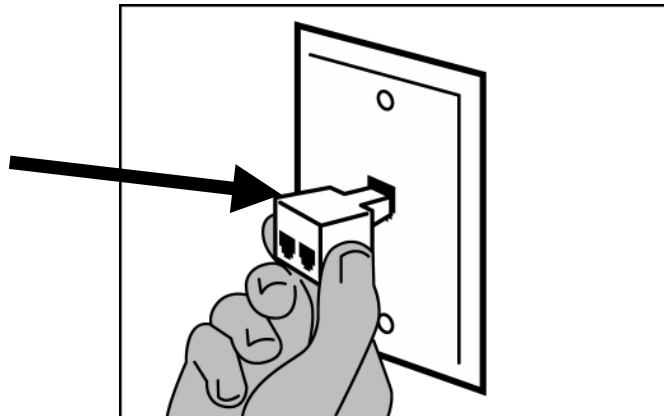

**3) Connect a filter to one side of the 2-way adapter**

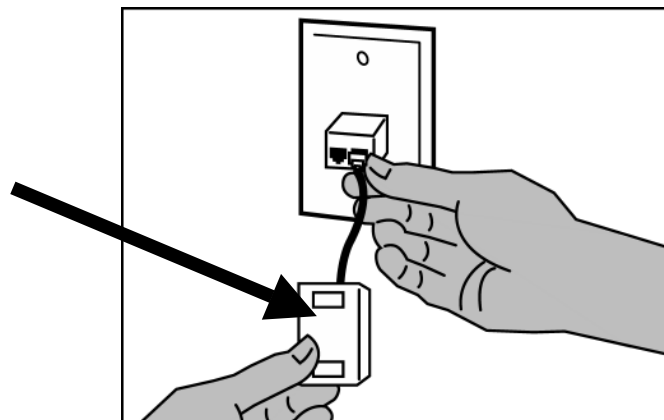

**4) If you have a phone, fax machine, analog modem or other phone device at this location, connect it to the filter**

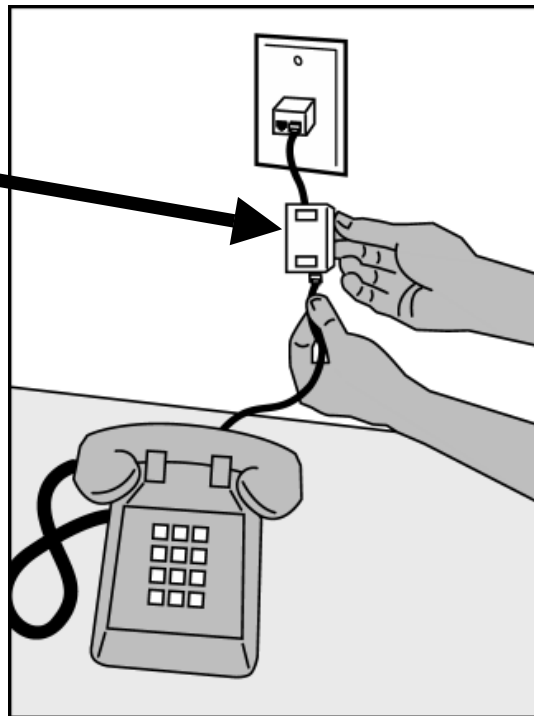

**5) Connect the data cable that will go to your DSL modem to the unfiltered side of the 2-way adapter**

To the DSL modem

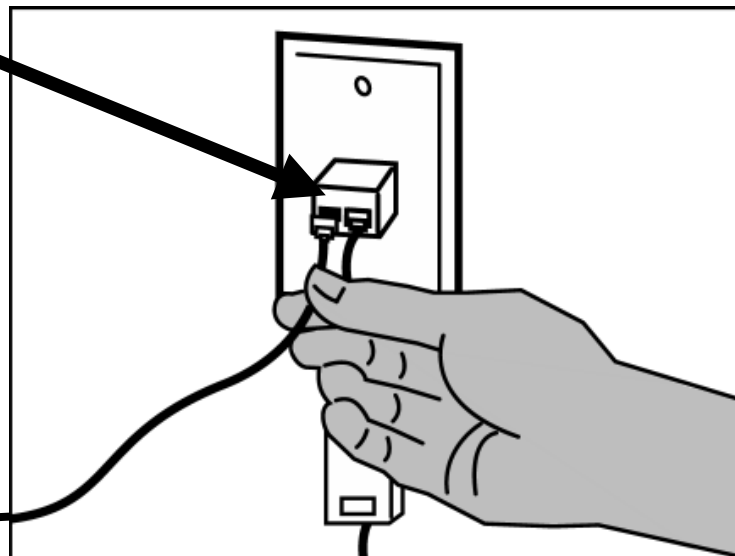

3-2 Install a filter on all other phones and phone devices



**Why do I need a filter on all my other phones and phone devices?**

Converting your regular phone line into a high-speed Digital Subscriber Line (DSL) can cause audible noise (high pitched tones and static) when you talk on the phone. You need to install a filter on every telephone or device that shares the same phone number as your DSL line to eliminate this noise.

**Other phones**

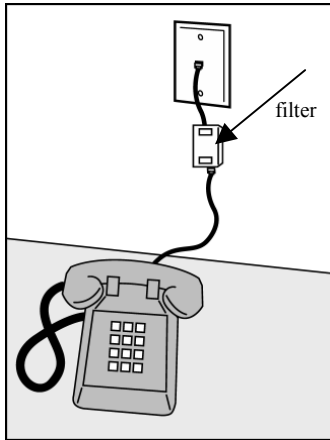

**Answering machines**

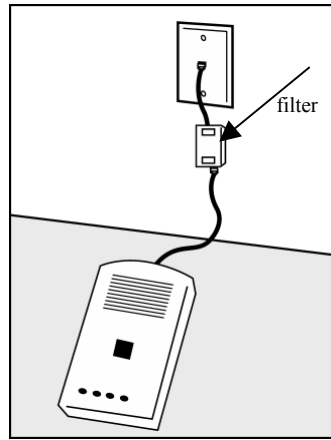

**Caller ID boxes**

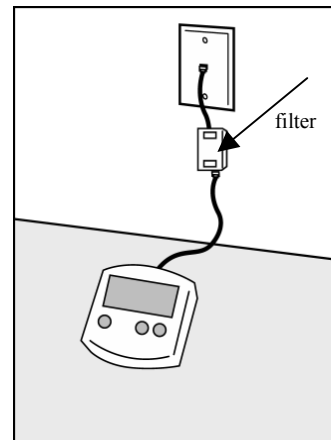

**Analog computer modems**

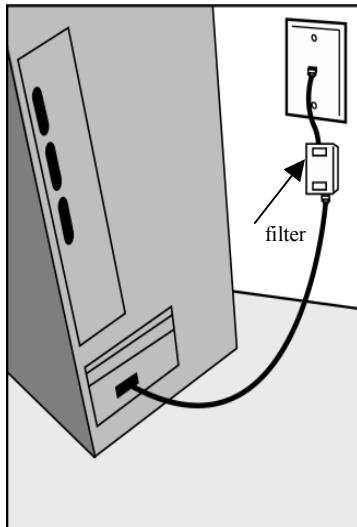

**Fax machines**

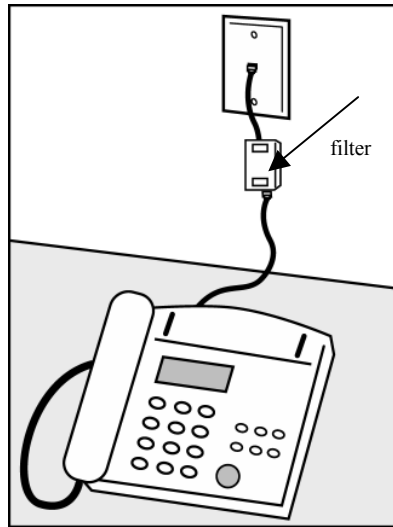

**Wall mount phones**

Use the wall mount filter shown

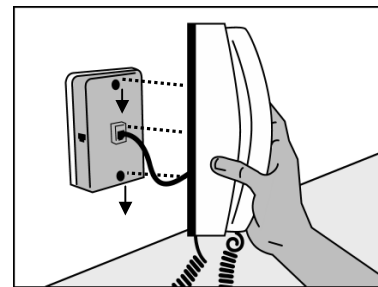
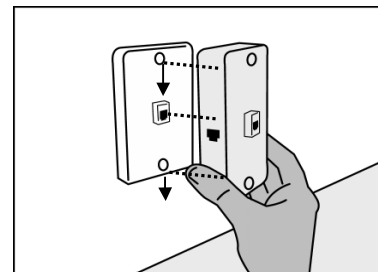

**Remember! Don't install a filter on the data cable that you are connecting to your DSL modem.**

3-3 Other filters you may encounter in your DSL Equipment Kit.

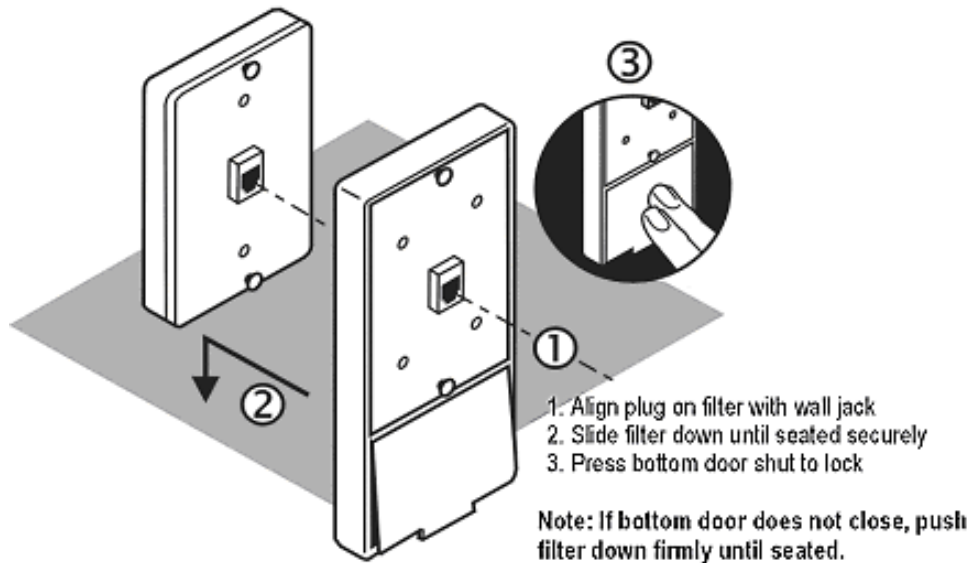
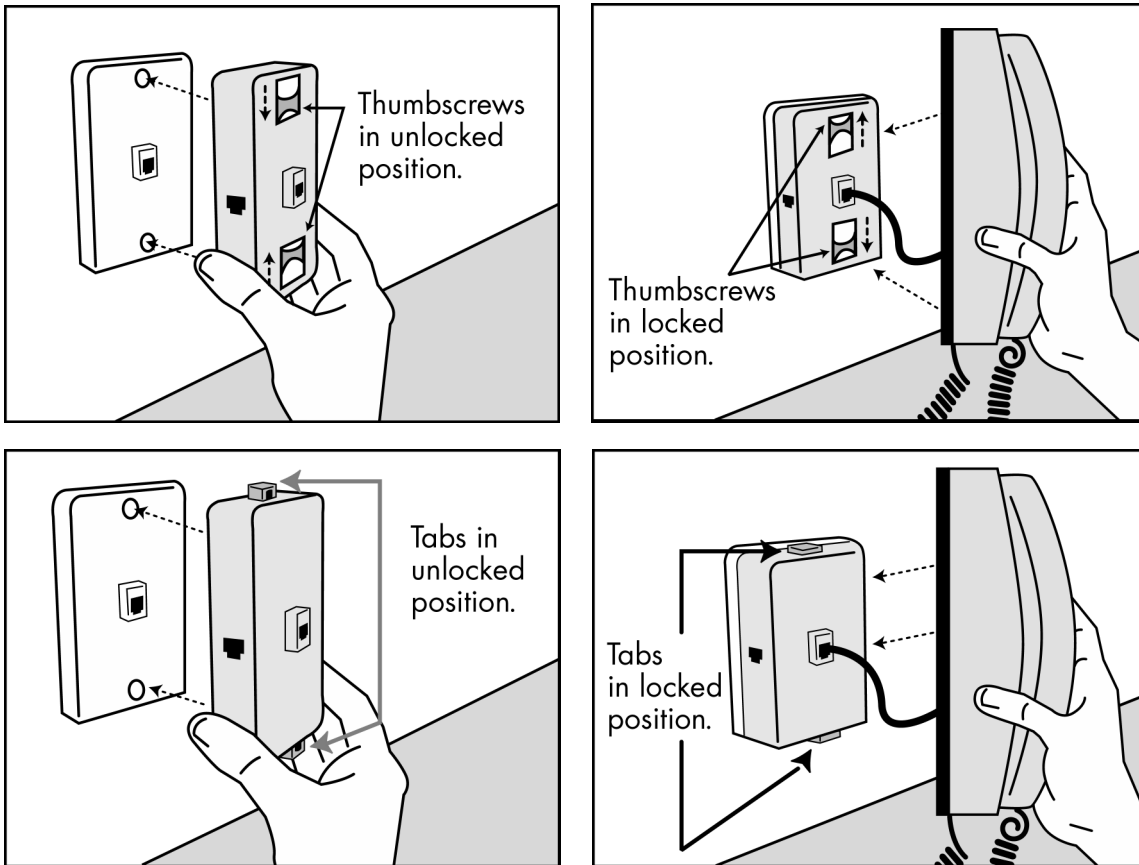



## **Step 4: Choose Your Modem and Minimum Requirements Check**

- 4-1 Insert the SBC Express CD into your CD-ROM drive. SBC Express should start automatically. If not, select **Run** from the Windows Start menu. Type “D:\Launch.exe”. (Substitute the appropriate letter of your CD-ROM drive for “D”.)
- 4-2 Select Alcatel Speed Touch PC and click **Next**.

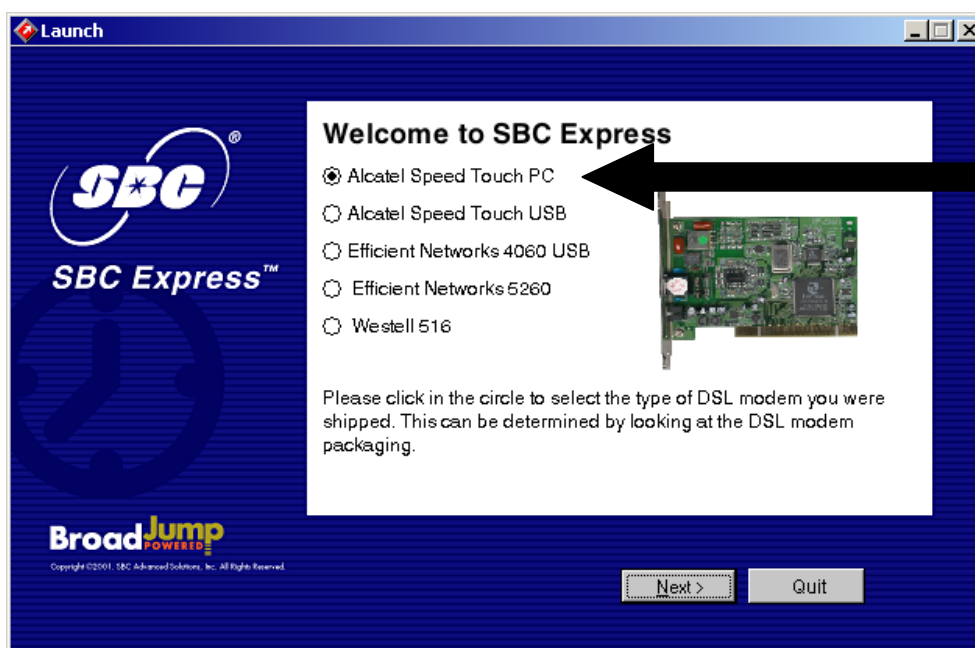

4-3 SBC Express displays the Welcome screen. Click **Next** to proceed.

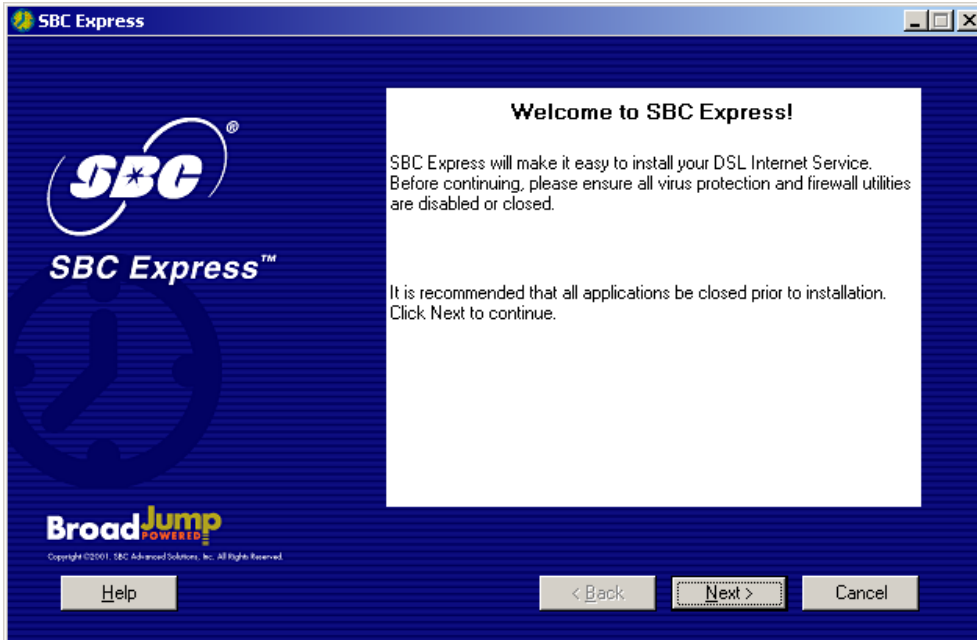

4-4 SBC Express displays the license agreement. If you agree to the terms, click **Accept**. If you do not accept, installation cannot continue.

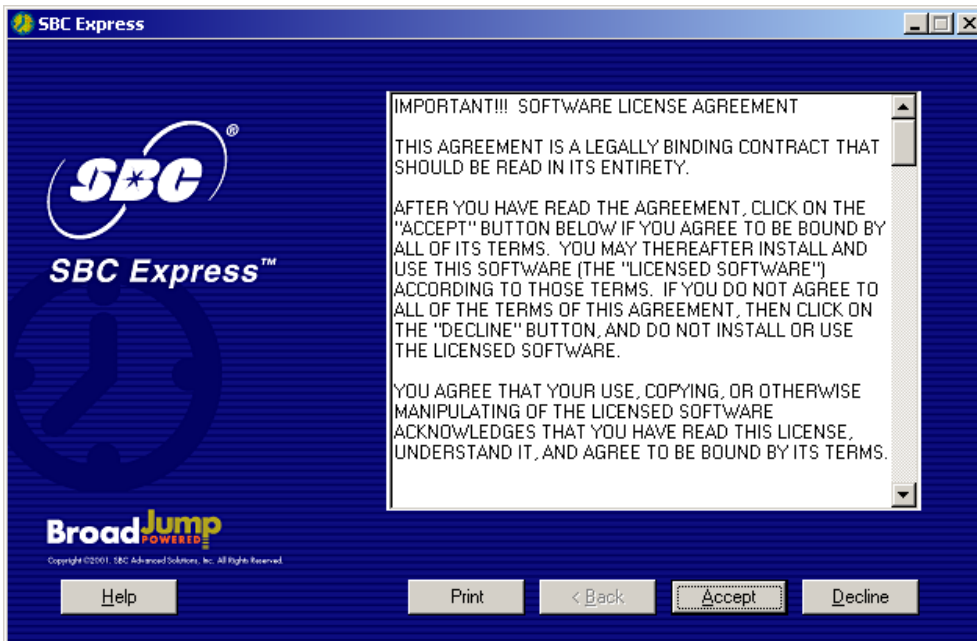

- 4-5 SBC Express now prompts you for your first and last name. Please type your first and last name and then click **Next** to proceed. Do not enter Technician Name.

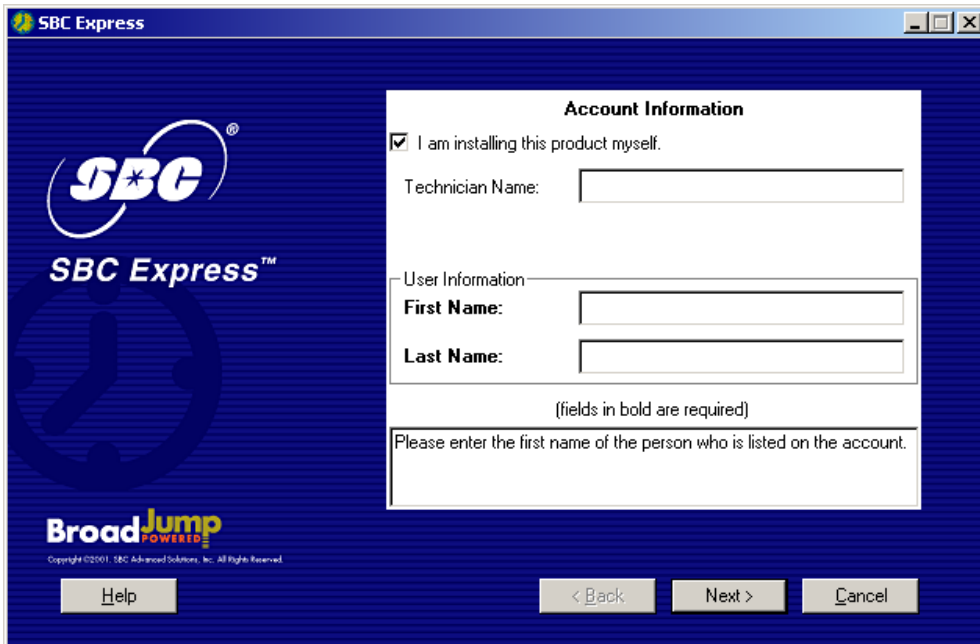

The screenshot shows the 'Account Information' window of the SBC Express installer. The window has a dark blue background with the SBC logo and 'SBC Express' text on the left. The main content area is white and contains the following elements:

- Account Information** header.
- A checked checkbox:  I am installing this product myself.
- A text input field for 'Technician Name'.
- A section titled 'User Information' containing:
  - A text input field for 'First Name'.
  - A text input field for 'Last Name'.
- A note: (fields in bold are required)
- A message: Please enter the first name of the person who is listed on the account.

At the bottom of the window, there are three buttons: 'Help', '< Back', and 'Next >', and a 'Cancel' button.

- 4-6 Enter your 10-digit DSL phone number in the next screen. Click **Next** to proceed.

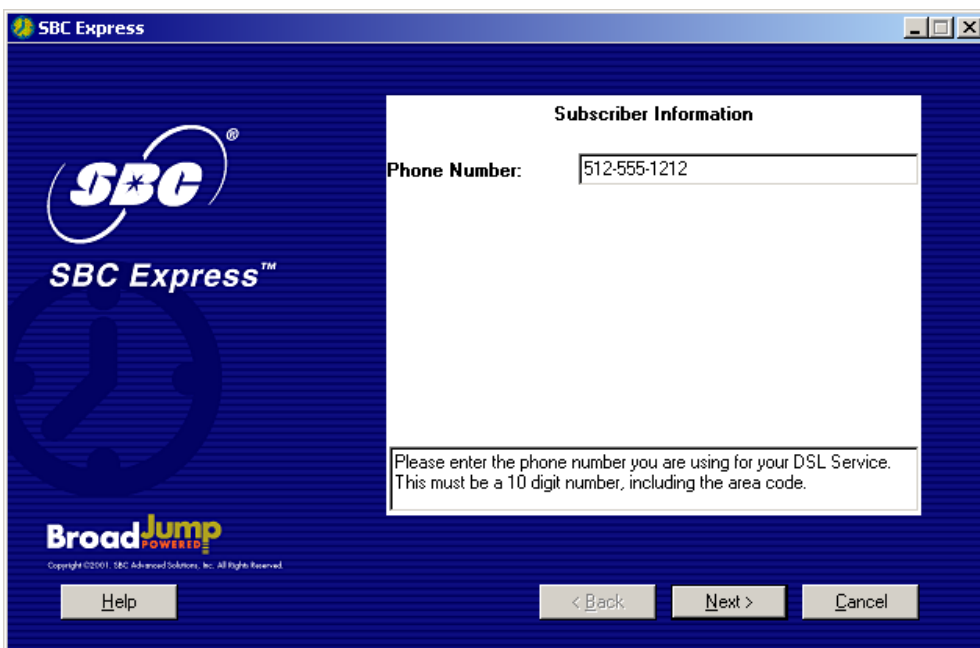

The screenshot shows the 'Subscriber Information' window of the SBC Express installer. The window has a dark blue background with the SBC logo and 'SBC Express' text on the left. The main content area is white and contains the following elements:

- Subscriber Information** header.
- A text input field for 'Phone Number' containing the value '512-555-1212'.
- A message: Please enter the phone number you are using for your DSL Service. This must be a 10 digit number, including the area code.

At the bottom of the window, there are three buttons: 'Help', '< Back', and 'Next >', and a 'Cancel' button.

- 4-7 SBC Express quickly checks your computer system to ensure that it meets the minimum requirements for DSL service.

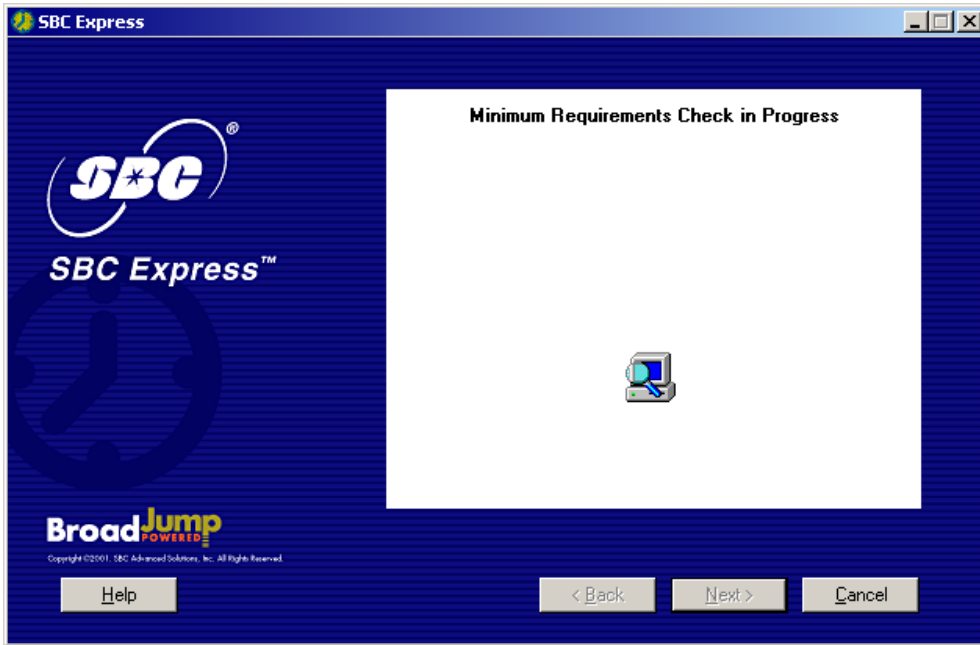

- 4-8 SBC Express has determined that you need to install the Alcatel Speed Touch PC. Click **Shutdown** and proceed to step 5 to install the Alcatel Speed Touch PC.

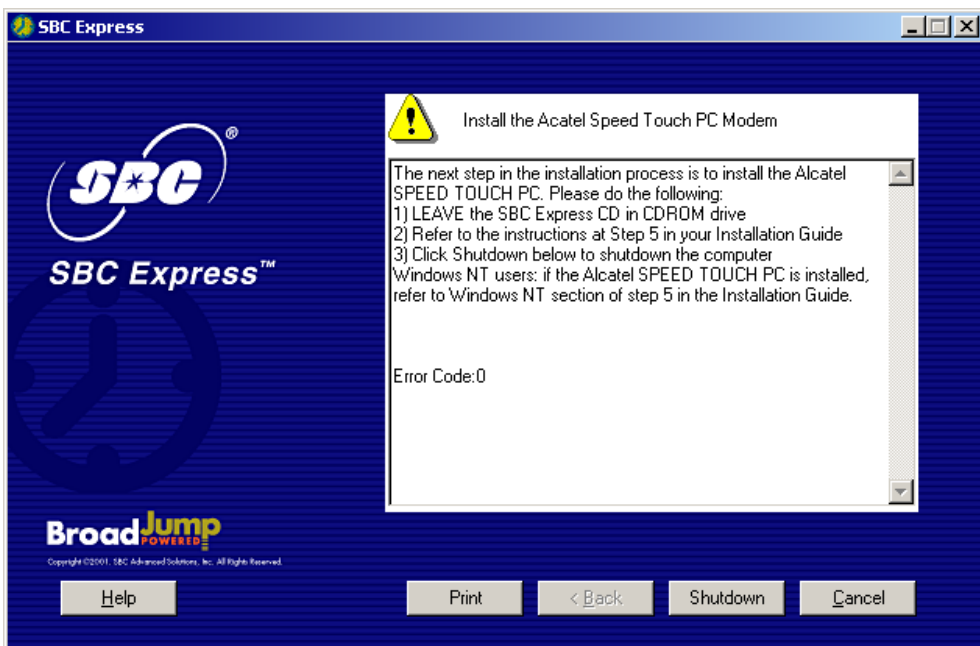

## Step 5: Installing the Alcatel Speed Touch PC

---

If you shutdown your computer, **leave the CD in the the CDROM drive**, and SBC Express will continue after you restart.

You should be at the following screen in the SBC Express Software:

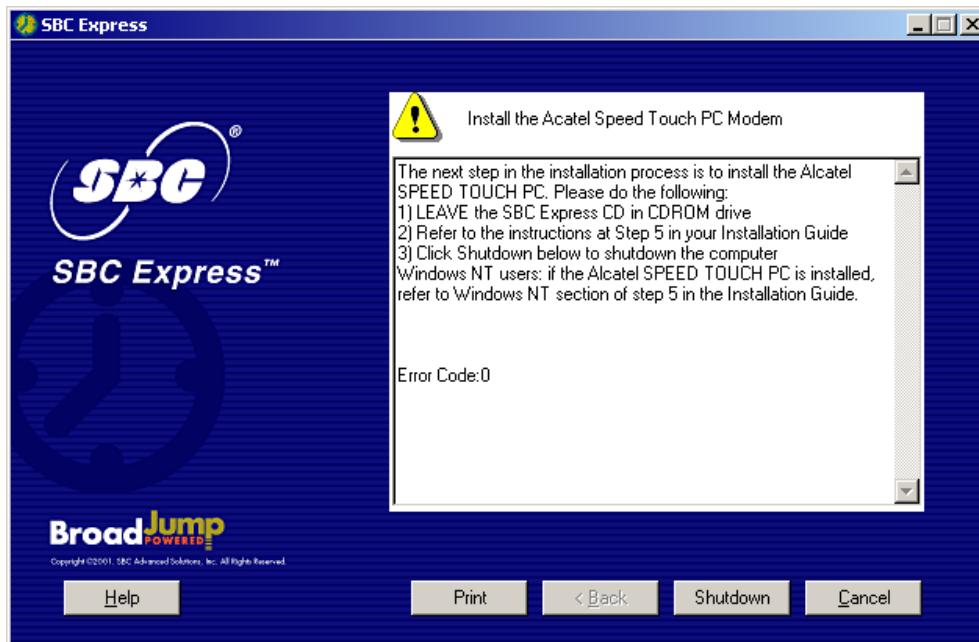

- 5-1 **Click Shutdown in SBC Express and then turn off all peripheral devices. Remember to leave the SBC Express CD in the CD-ROM drive.**
- 5-2 Unplug the power cord for your computer from the electrical outlet.
- 5-3 Open the case of your computer (review your computer manufacturer's Owner's Manual for specific instructions).
- 5-4 Touch the computer chassis (metal frame) before touching the Alcatel Speed Touch PC adapter. This helps to protect the Alcatel DLS Modem from static electricity.
- 5-5 Locate an available PCI slot (usually white in color). You may use any available PCI slot. Make sure you are looking downwards on the PCI slot. You may need to turn the computer on its side to accomplish this (*review your computer manufacturer's Owner's Manual for specific instructions*).

- 5-6 Remove the metal PCI slot cover from the unused PCI slot, and retain the screw.

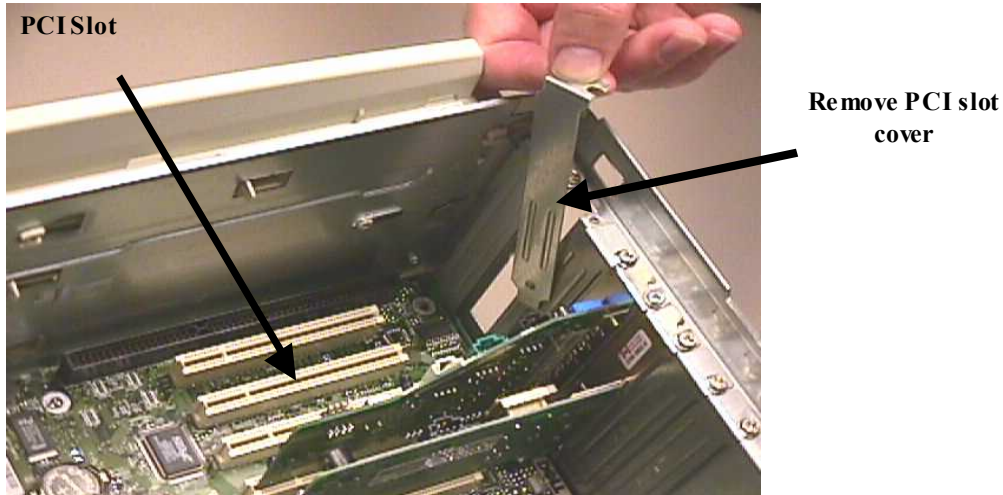

- 5-7 Carefully insert the Alcatel Speed Touch PC adapter into any empty PCI slot. Make sure the card is completely seated by pressing firmly.
- 5-8 Verify that the end bracket is flush against the chassis. Make sure the gold connectors along the base of the Alcatel Speed Touch PC adapter are completely and evenly inserted into the PCI slot.

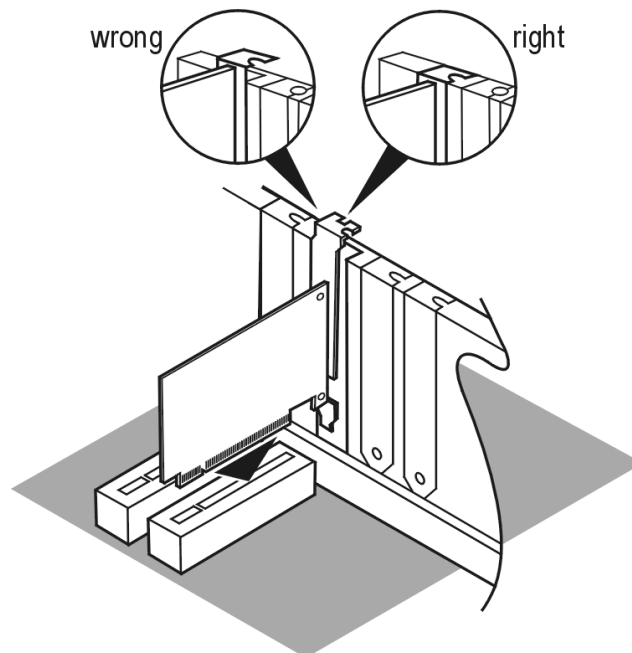

- 5-9 Fasten the card into the computer chassis with the screw you set aside earlier.
- 5-10 Replace the computer cover. Plug the power cord back into the electrical outlet, making sure the **SBC Express CD is in the CD-ROM drive.**

## Installing the Alcatel Speed Touch PC® Software

5-11 Turn on your computer.

- **NOTE: Windows NT will NOT automatically detect your Alcatel Speed Touch PC® adapter. SBC Express will display the screen below. Please IGNORE this screen and proceed to step 5-12. Do NOT Cancel SBC Express.**

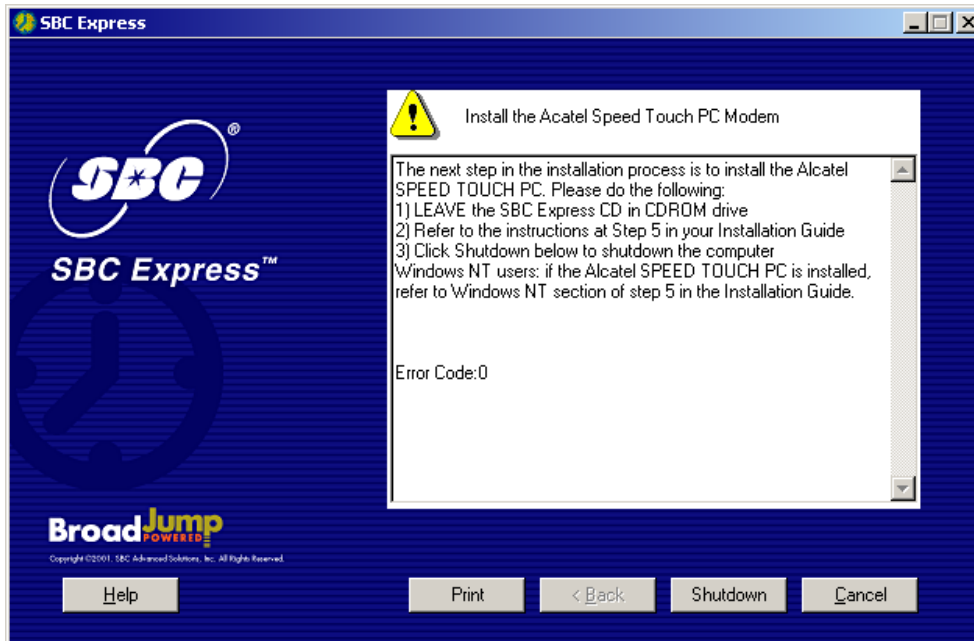

5-12 Right click on the Network Neighborhood icon and select **Properties**.

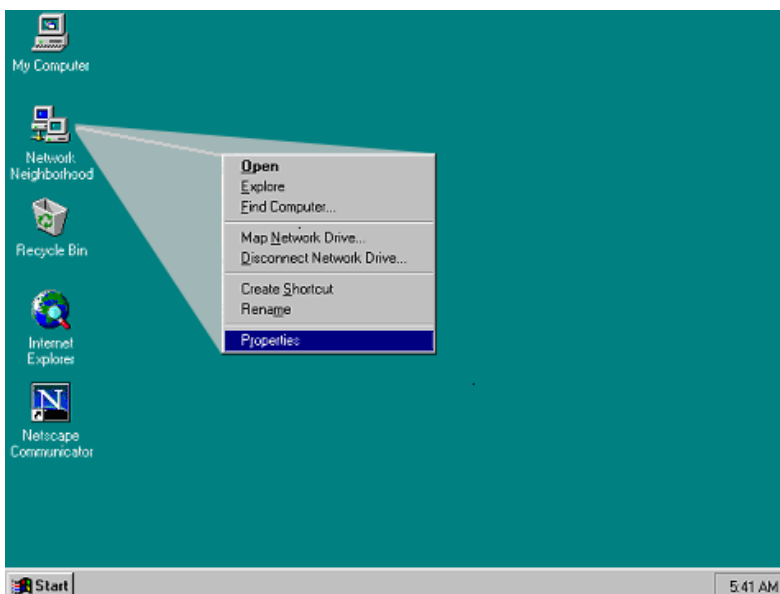

5-13 Click on the **Adapters** tab.

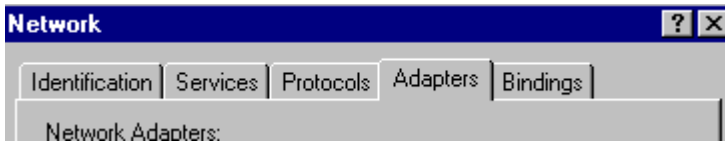

5-14 Click on the **Add** button.

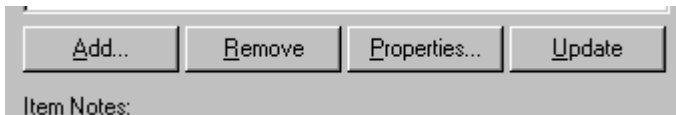

5-15 Click on the **Have Disk** button.

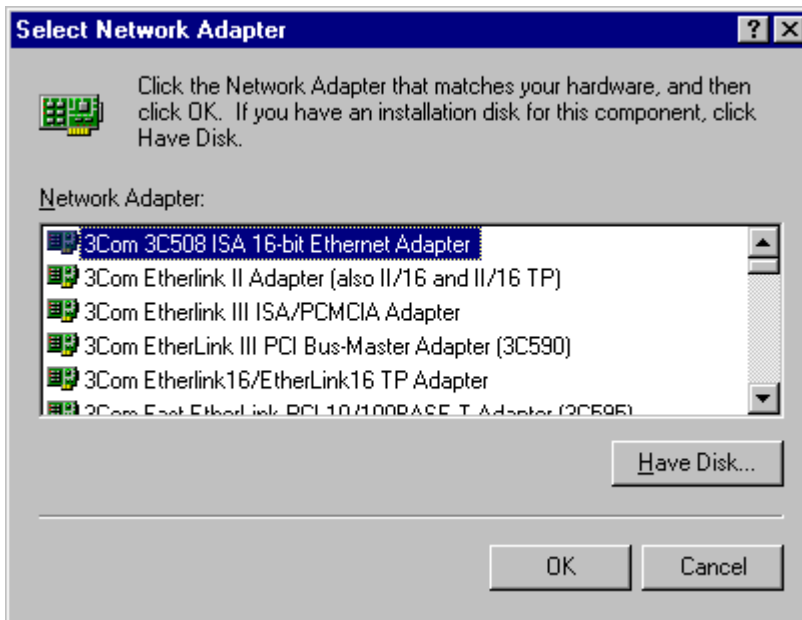

5-16 The SBC Express has copied all the necessary files to "C:\Temp". At this prompt please type in **C:\Temp** and click **OK**.

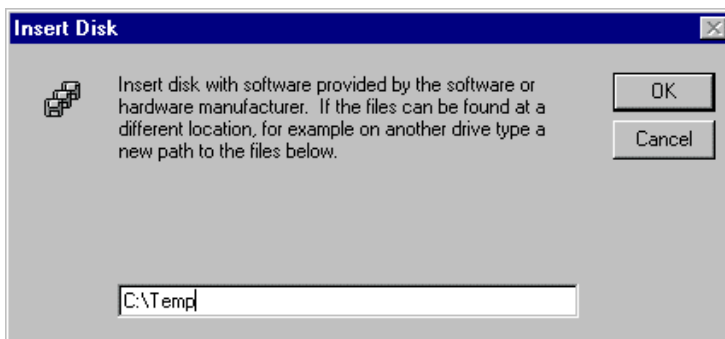



- 5-17 Windows NT will present the following select OEM option screen, select **ITeX ADSL PCI NIC** and click **OK**. (Note: The IteX ADSL PCI NIC is the Alcatel Speed Touch PC adapter. This is the formal adapter name used for NT)

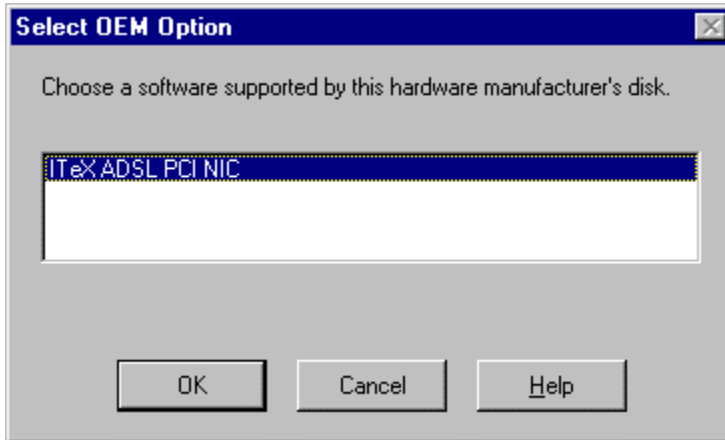

- 5-18 After you install the driver software, the ITeX ADSL PCI NIC will appear under Network Adapters. Click **Close**.

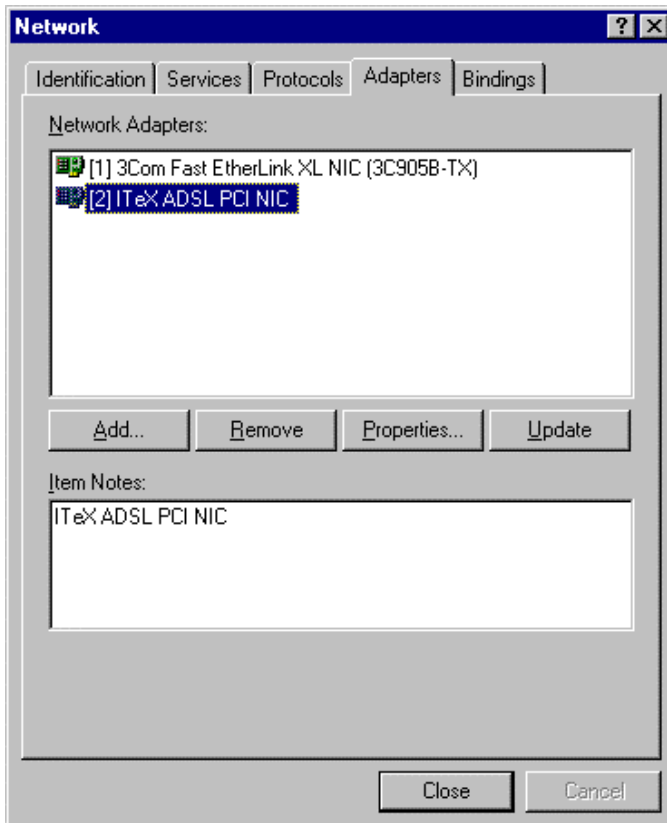

- 5-19 You will be prompted to bind a TCP/IP address to the Adapter. Select the **ITeX ADSL PCI NIC** in the drop down box in the Microsoft TCP/IP Properties window shown below. Next, click “**Obtain an IP address from a DHCP server.**” This selection will cause the Microsoft TCP/IP window (also shown below) to appear. Click **Yes** to this screen and then **OK** on the Microsoft TCP/IP Properties window.

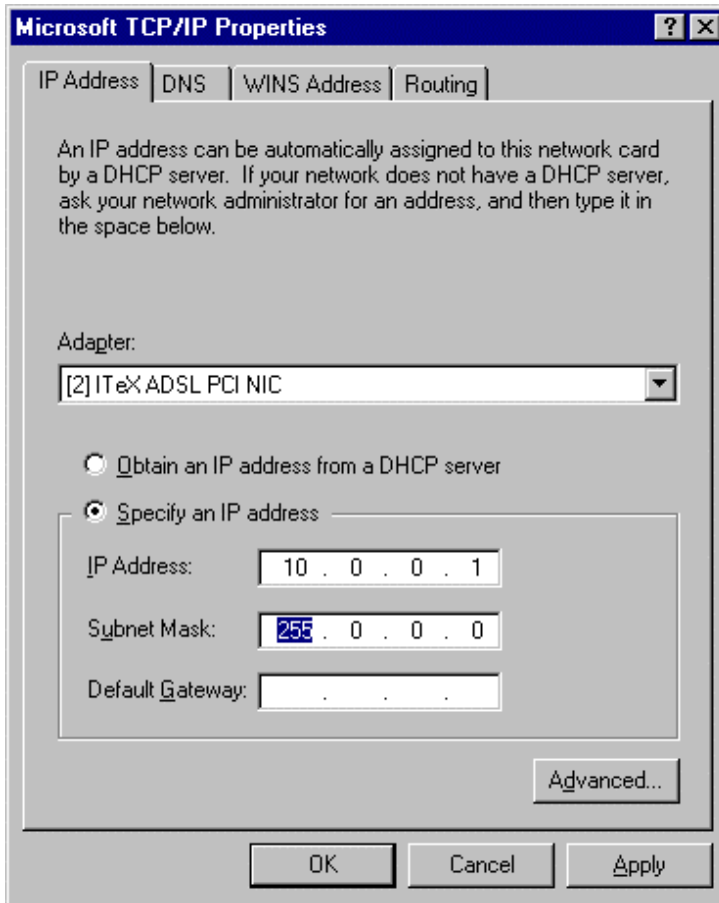

- 5-20 You will be prompted to reboot the system. This may take several ( 3-5 ) minutes as network settings are established. **BE SURE TO LEAVE SBC EXPRESS CD IN CD-ROM DRIVE.** Click **Yes.**

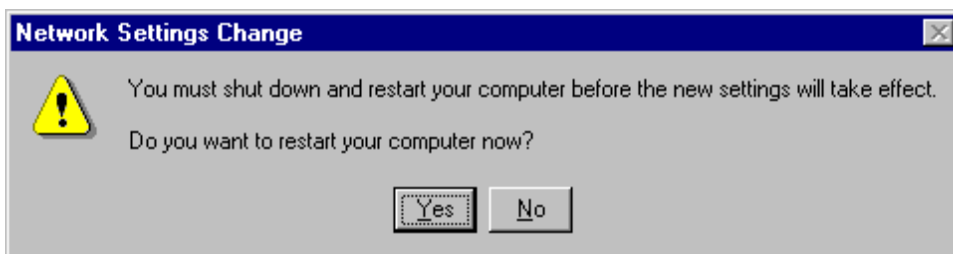

- 5-21 SBC Express will re-run the Minimum Requirements test and detect the newly installed Alcatel Speed Touch PC adapter and complete, stopping at the following screen. If problems are detected follow the instructions on the screen or look at the troubleshooting section of this manual for further information. **Follow the instructions in Step 6 beginning on the next page before continuing.**

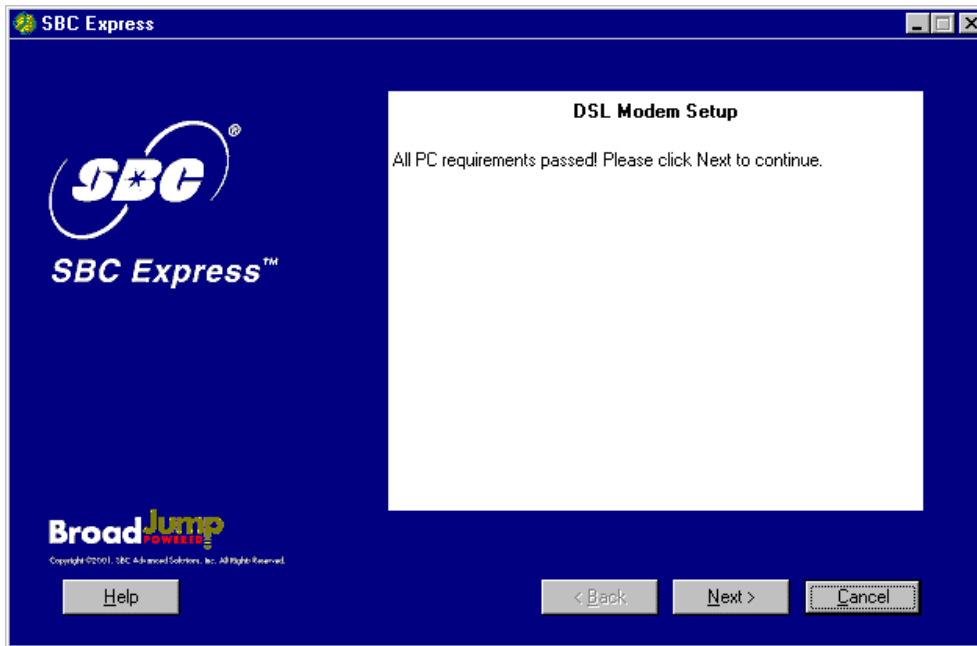

## Step 6: Finish Configuring Your System

- 6-1 If the Alcatel Speed Touch PC card is installed properly, you will see the following screen. You must now connect the Alcatel Speed Touch PC to the phone jack prepared in Step 3.

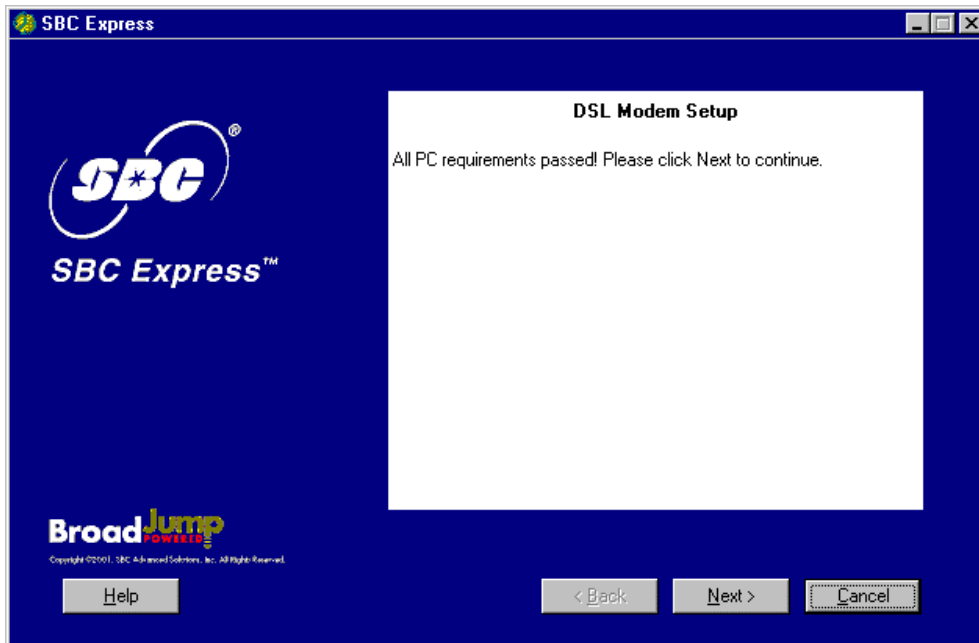

- 6-2 Connect the Alcatel Speed Touch ADSL modem, see diagram below.

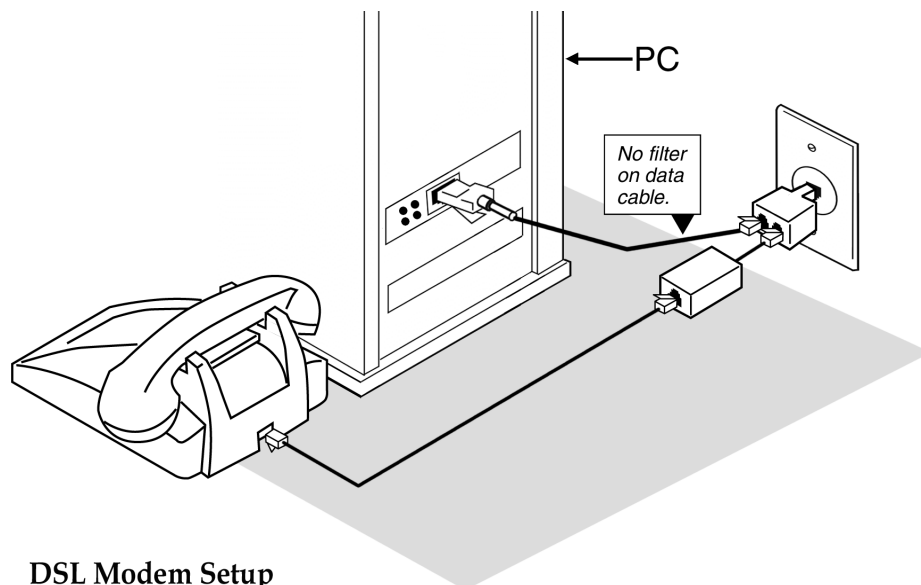

DSL Modem Setup  
with Two-Way Adapter

- 6-3 To determine if your DSL modem has made a good connection look at the icon in the system tray. If both lights are black then you have a good connection. If either light is red or there is a red circle with a slash through it then check the diagnostic guide in appendix E for help.



- 6-4 SBC Express will install additional software necessary for your service. **Leave the SBC Express CD in the CD-ROM drive.** You will see the following screen during the software installation. Your machine may reboot during this process.



- 6-5 You have finished software installation for DSL. Click Finished in SBC Express window and then proceed to Step 7 to configure the connection to your Internet Service Provider.



## Step 7: Create a Connection Profile

---

### 7-1 Setup a New Profile in EnterNet 300.

- Double-click on the desktop **EnterNet 300** icon.
- In **Profiles**, double-click on the **Create New Profile** icon.

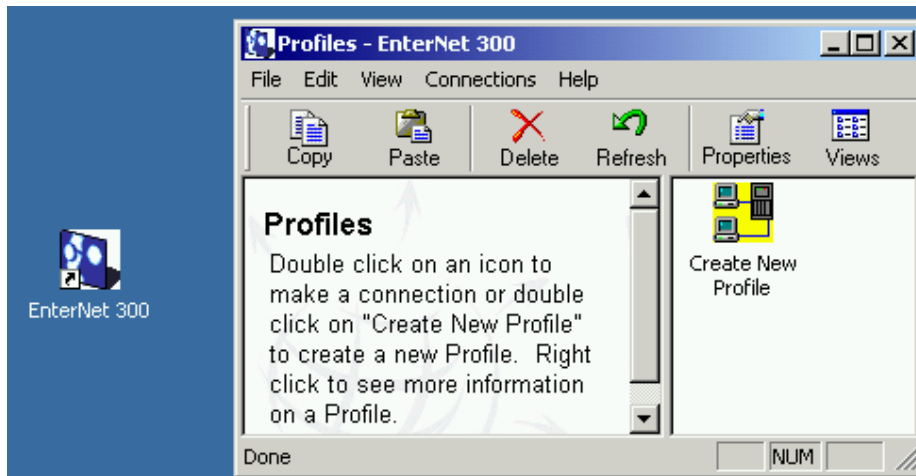

7-2 You will be prompted to supply a name for the connection. Enter the Profile Name as **DSL Connection**. Click **Next**.

7-3 Locate your ISP provided **User ID** and **Password**. Set up the DSL Connection profile by typing the **User ID** and **Password** in the User Name and Password fields. Click **Next**.

7-4 Leave the **Server** and **Service** fields BLANK. Click **Next**.

7-5 Click **Finish** to save the configuration.

7-6 Double-click the new **DSL Connection** icon in the Profiles Dialog box.

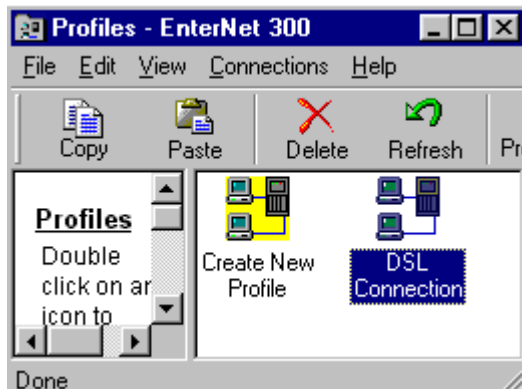

7-7 A Connection dialog will open. Click **Connect**.



7-8 **Double-click** on the EnterNet icon in the system tray (next to the clock, in the lower-right corner of your screen) and select **Disconnect**.

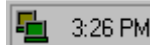

**EnterNet Icon**

7-9 Double-click the EnterNet 300 folder on your desktop and then double-click **DSL Connection** icon.



7-10 Open your browser again and test your connection by visiting your favorite web sites.



# Appendices

## **APPENDIX A**

---

### **Having Trouble?**

If the suggestions below don't resolve your problem, technical support is available from your Internet Service Provider. Please refer to the Internet Service Provider's information on how to contact them for technical assistance.

### **I can't open my computer case. What do I do?**

- Consult your computer manufacturer's Owner's Manual.
- Call your computer manufacturer's Support Line.

### **I can't connect. What do I do?**

- Make sure there is no filter on the phone jack/cord connected to your DSL modem
- Check your Ethernet cable connection. Is it secure?
- Verify that you are installing your DSL equipment AFTER the "Service Completion Date" given to you when you ordered your DSL Internet Service.

## APPENDIX B

---

### Uninstall/reinstall the Alcatel Speed Touch PC® Adapter

#### Uninstalling (and reinstalling) the Alcatel Speed Touch PC® adapter in Windows® NT

1. Select *Start -> Settings -> Control Panel*. Double-click the **Network** icon and choose the **Adapters** tab.
2. Highlight the **Alcatel Speed Touch PC® Adapter** and click the **Remove** button.
3. Click 'Yes' to remove the component from the system when prompted.

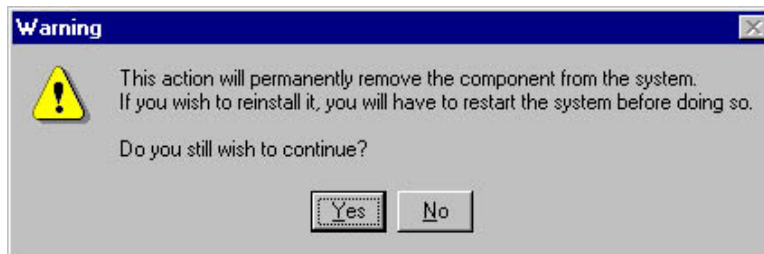

4. Click the **Close** button to close the Adapters window.
5. Shut down the desktop or laptop. Turn OFF and unplug the computer and any peripheral devices.
6. Remove the Alcatel Speed Touch PC® Adapter Card.
  - Open the computer case using your computer manufacturer's instructions and then, remove the screw holding card in place.
  - Carefully remove the Alcatel Speed Touch PC® Adapter card from the PCI slot.
7. Reinstall the card following procedures in Step 5.

## APPENDIX C

---

### Adding TCP/IP to Windows NT

Right click on the network neighborhood icon and select properties.

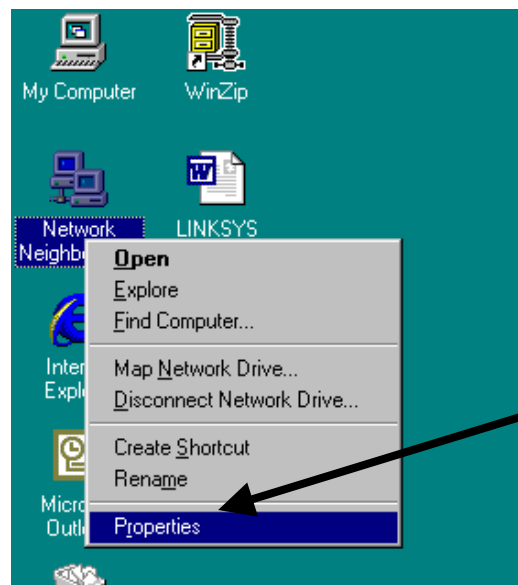

2. Click on the 'Protocols' tab and click 'Add'.

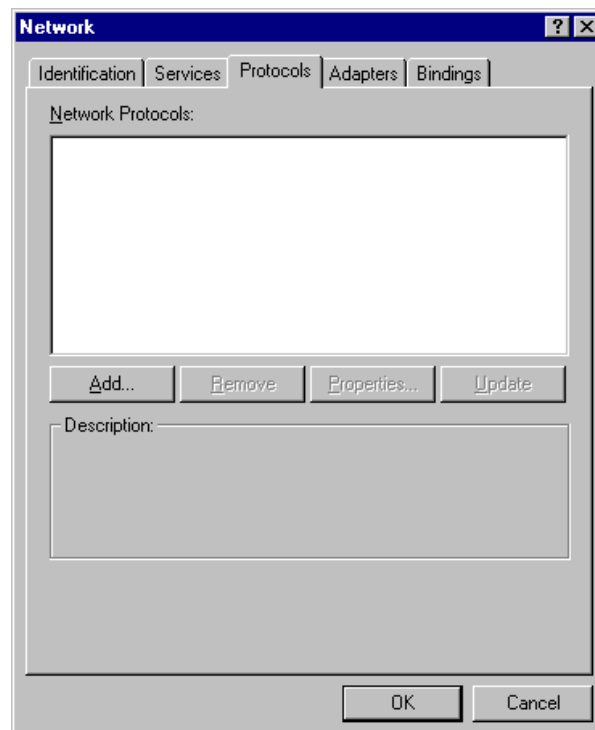

3. Select the 'TCP/IP Protocol' and click 'OK.'

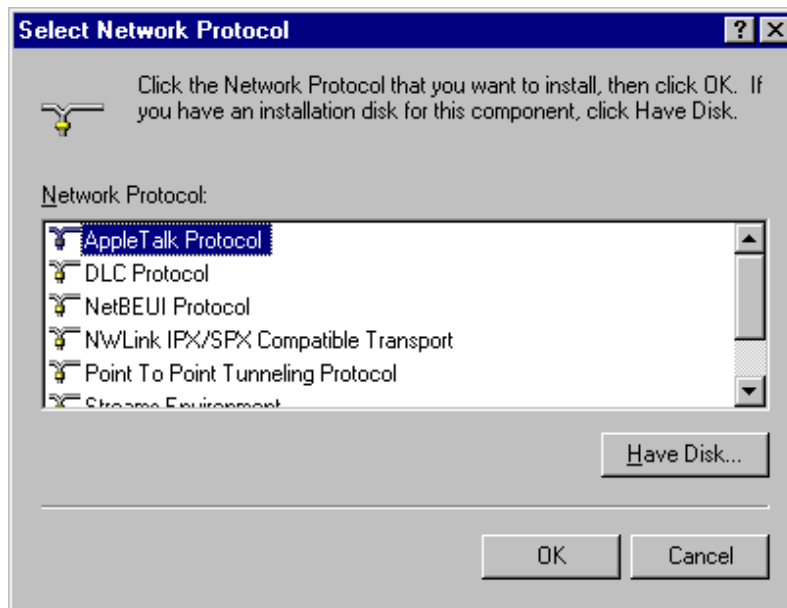

4. Specify the path of your NT installation files **or** insert the Windows NT CD-ROM and specify the I386 folder.

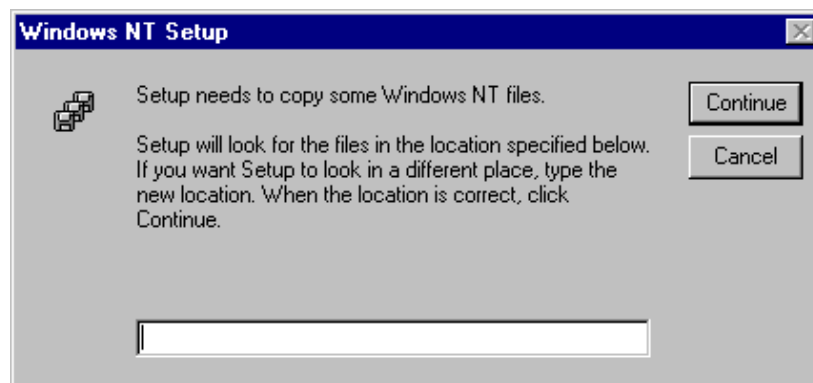

5. Select "No" when NT asks 'Do you wish to use DHCP?'

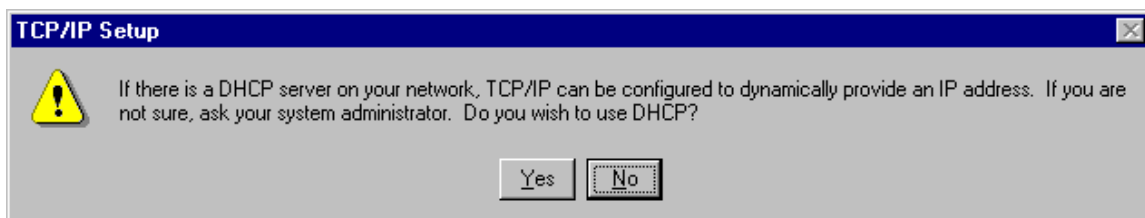

6. After clicking “No”, TCP/IP should appear under the protocols tab.

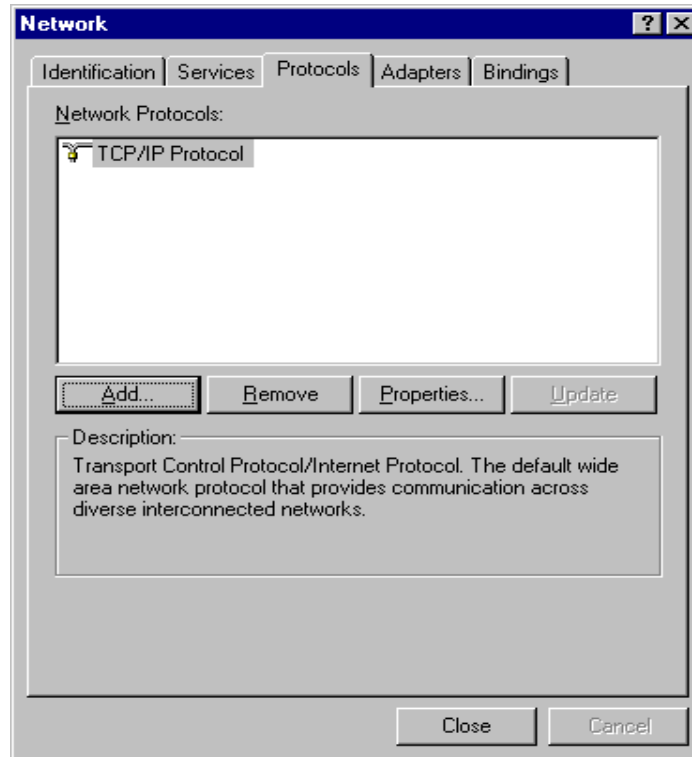

7. Click “Close” to bind all the information. You must restart your computer for the settings to be stored.

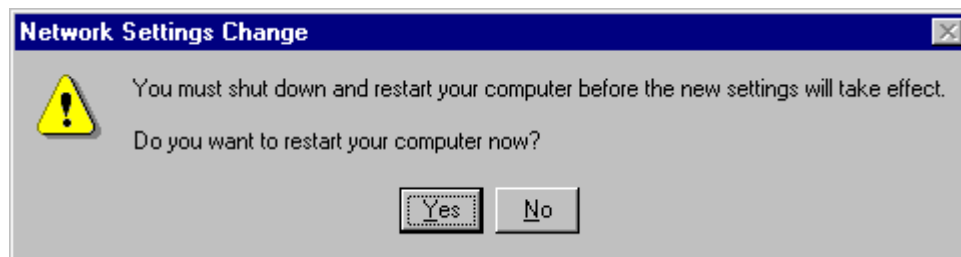

## APPENDIX D

### Troubleshooting SBC Express

Please refer to this list if you are having problems using SBC Express or if you receive an error message. If after troubleshooting, you are still having problems, then you should contact your Internet Service Provider for assistance.

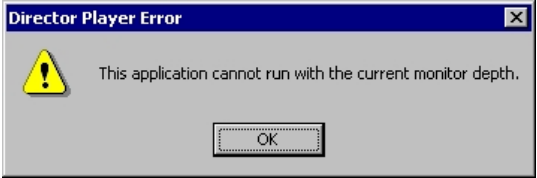
Step	Problem	Solution
Launch	<p>The following dialog appears:</p> 	<p>Reset your display to 256 colors or more. SBC Express will not run in 16 color mode.</p> <p>From the start menu, choose “settings-&gt;control panel”. Double-click “Display” and choose the “settings” tab. Select more colors from the “colors” pull-down list.</p>
Minimum Resources	<p>SBC Express verifies minimum requirements on several resources including hard drive space, RAM, operating system level, and processor speed and family.</p> <p>If any of these resources are under the required value, an error will display describing which resource did not meet the requirement.</p>	<p>Update your computer to the recommended resource level.</p>
Installing Network Interface Card	<p>When installing Network Interface Cards on Windows systems the installation process may ask for the original installation disk.</p>	<p>Some of these files can be found in the SYSTEM directory or the WINDOWS directory of the machine. If not, you will have to provide an installation CD-ROM for the installation of the drivers to be successful.</p>
Incompatible Adapter	<p>This scenario can occur when a machine had a previous NIC or Network Adapter installed, but the physical device is missing or was misconfigured.</p>	<p>Use the “Fix” button to launch the appropriate system control panel along with context sensitive help. The help provided will guide you through the steps to disable or remove the adapter.</p>
Missing Internet Protocol	<p>This scenario can occur if Client for Microsoft Networks is not installed with the TCP/IP protocol or if the NIC is installed without binding TCP/IP to the NIC.</p>	<p>Use the “Fix” button to launch the appropriate control panel and context sensitive help to guide you in binding TCP/IP to the network adapter.</p>
Disabled Network Adapter	<p>This scenario can occur when a NIC is present in the system, yet the adapter has been disabled.</p>	<p>Use the “Fix” button with context sensitive help to guide you through enabling the adapter.</p>

Unknown Network Interface Adapter	This scenario can occur if a NIC is physically present and detected by Plug-n-Play, but no drivers were installed for the NIC. Windows will add this device to the "Other Devices" section in the Device Manager.	Use the "Fix" button to launch the appropriate control panel and context sensitive help to guide you through removing the "Unknown device".
Ping Test	The Ping Test is usually accomplished within the Configure TCP/IP step, where SBC Express pings the default gateway. An explicit IP address can also be used.	<p>Failure during this test can occur from invalid network settings, the Ethernet cable not being plugged in, the DSL modem not being in synch, or if the specified IP address does not allow a ping.</p> <p>Make sure your Ethernet cable is plugged in and powercycle your DSL modem. Use the "Retry" button to try the test again.</p>
DNS Test	The DNS Test will determine the currently defined DNS servers, attempt to ping them, and upon a successful ping, will resolve a specified hostname to an IP address.	This test can fail if the DNS server is invalid. If you entered static IP information, ensure you entered the DNS servers correctly.



## APPENDIX E

---

### Modem Diagnostic Lights

To help identify a problem with the modem connection please look at the icon on located in the system tray as seen below.

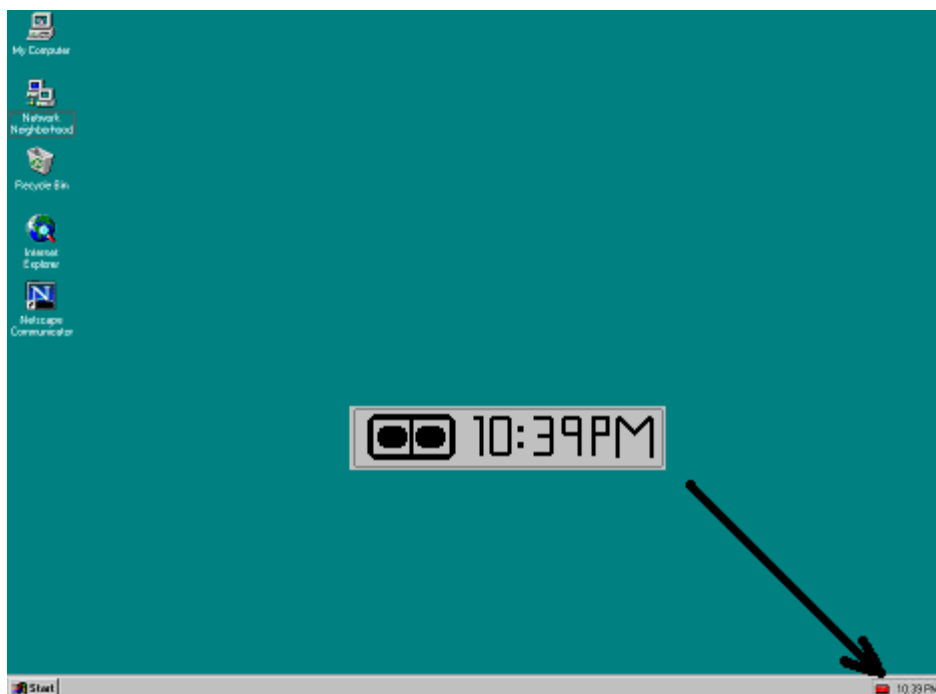

By comparing the lights to the table below you should be able to determine the problem.

### Diagnostic Icon

Red, Red	No ADSL connection or handshaking. Check your cable.
Black, Yellow	Handshaking (flashing yellow alternating position).
Black, Black	No data traffic or idle connection.
Black, Green	Modem is receiving data.
Green, Black	Modem is transmitting data.
Green, Green	Modem is receiving and transmitting data
Red Circle With Slash	ADSL modem is either disconnected or a driver installation problem exists

### **This concludes the DSL Equipment Installation Guide**