

ZVC42LSS GE Monogram® 42" Custom Hood Insert

Custom Insert Liner

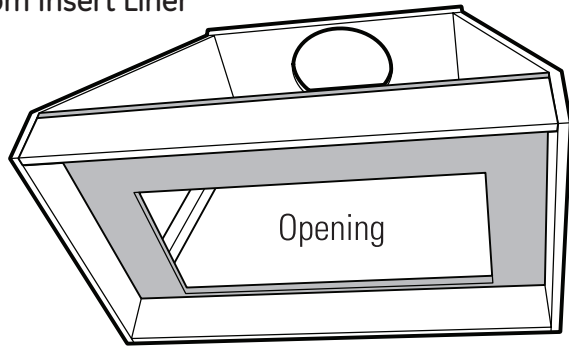

The custom canopy must be sized to fit the insert sleeve. Construct the canopy with an opening that is:
38-3/4"W x 13-3/16"D
The opening must be constructed of 3/4" thick material to allow the sleeve locking clips to engage.

The Supplied Liner

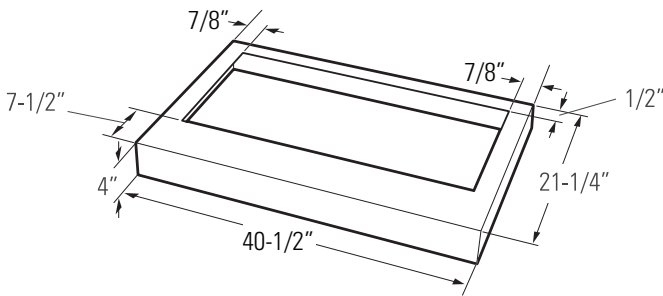

A stainless steel liner is shipped with each hood insert. This non-combustible liner protects the underside of the canopy. Custom Liner
If you are not using the supplied liner, you may construct a custom non-combustible liner. Use the supplied liner as a template. The opening must be 38-3/4"W x 13-3/16"D. 3/4" thick material must surround the opening to allow the sleeve locking clips to engage. The insert sleeve inside the cabinet should be positioned 1/2" from the rear wall so that the center of the 8" duct is 5-1/2" from the rear wall.

For answers to your Monogram®, GE Profile™ or GE® appliance questions, visit our website at ge.com or call GE Answer Center® service, 800.626.2000.

Dimensions and Specifications (in inches)

Outside Dimensions

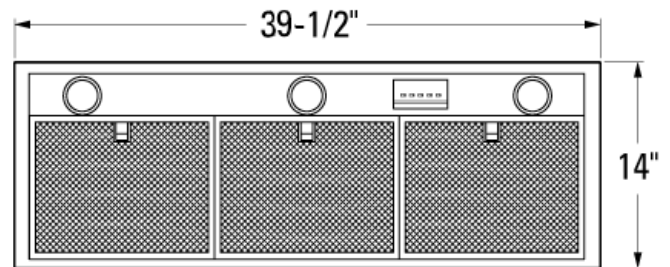

The Insert Sleeve

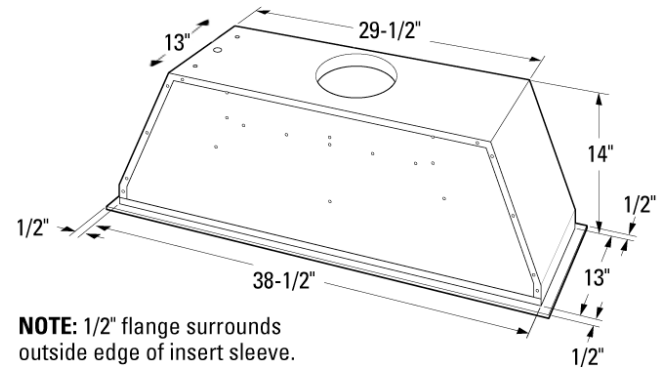

Remote Location for the Control

The control may be removed from the hood and installed into a wall or countertop. A 30-ft length of wire is supplied to accommodate most installations. A blanking plate covers the opening when the controls are removed. The overall size of the control is 4-1/4" wide and 2-1/4" deep.

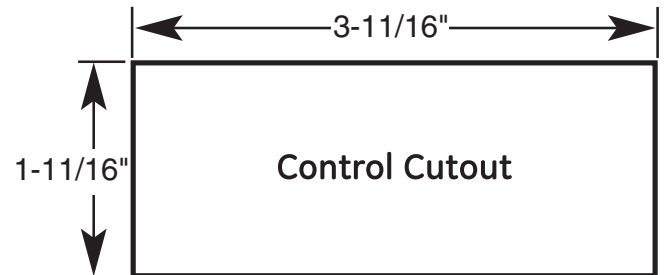

We recommend that the cutout in granite or other hard surfaces be made before the countertop is installed.

ZVC42LSS

GE Monogram® 42" Custom Hood Insert

Features and Benefits

- Patented Installation Process - Makes the insert ideally suited to a wide variety of custom hood applications; with easy and secure connection to the ventilation duct
- Dual-Blower Ventilation with 1200 CFM and 4 Fan Speeds - Provides the power necessary to capture the smoke and fumes produced by high-performance cooking equipment
- Control with ADA Compliant Remote-Mount Option - Can be removed and relocated to a more convenient location, such as a wall or countertop
- Blower, Liner and Filters Included - No additional components or accessory kits required
- Three Halogen Lights - Provide four levels of illumination over the cooking surface
- Three Stainless Steel Mesh Filters - Trap airborne grease particles and can be easily removed for safe cleaning in your dishwasher
- Model ZVC42LSS - 42" Wide Stainless Steel Hood Insert

