

Microwave Oven

Owner's Manual



Safety Information.....

2

- Welcome...2
- Grounding...4
- Excessive Energy Warning...5
- Features and Benefits, Specifications...6



Operating your microwave.....

8

- Setting up your microwave...8
- Parts and Accessories...8
- Turntable Installation...8
- Control Panel...9
- Power Levels...10
- Clock...10
- Voice On/Off...10
- Add 30 Seconds...13
- One Stage Cooking...12
- Two Stage Cooking...12
- Defrost...13
- Memory Function...16
- Clock Function...16
- Child Lock...10
- Kitchen Timer...16
- Express Cooking...13



Preset functions.....

14

- Beverage...14
- Popcorn...14
- Potato...14
- Pizza...14
- Soup...15
- Dinner Plate...15
- Fresh Vegetable...15
- Frozen Vegetable...15



Use and Care.....

17

- Care and Cleaning...17
- Troubleshooting...18
- Warranty...19
- Technical Support...19
- Ordering Parts...19

Welcome!

Congratulations, you have acquired a high quality Hamilton Beach™ Microwave Oven. This unit is packed with many extra features that you will find convenient to use. TEMO the talking microwave comes with the exclusive, easy-to-use i-Talk interactive talking feature that actually talks you through each step of the microwave cooking process, five memory settings and eight different one-touch cooking buttons provide for convenient meal preparation and tasty snacks. It will provide you with many years of trouble free use if you follow the safety precautions and operating instructions provided in this easy-to-use manual. Please take the time to read it, and save these instructions for future use. Please also remember to record the serial number and series code. They are on a label on back of the unit. Save your receipt by stapling it to this manual for convenient access.

Model number: **87108**

Serial number _____

Series code _____

Date of purchase _____

!! IMPORTANT SAFETY INSTRUCTIONS !!

When using electrical appliances, basic safety precautions should be followed, including the following:

WARNING! - To reduce the risk of burns, electric shock, fire, injury to persons, or exposure to excessive microwave energy:

- 1) Read all instructions before using the appliance.
- 2) Read and follow the specific "PRECAUTIONS TO AVOID POSSIBLE EXPOSURE TO EXCESSIVE MICROWAVE ENERGY" found on page 5.
- 3) This appliance must be grounded. Connect only to properly grounded outlet. See "IMPORTANT GROUNDING INSTRUCTIONS" found on page 4.
- 4) Install or locate this appliance only in accordance with the provided installation instructions.
- 5) Some products such as whole eggs and sealed containers – for example, closed glass jars – are able to explode and should not be heated in this oven.
- 6) Use this appliance only for its intended use as described in the manual. Do not use corrosive chemicals or vapors in this appliance. This type of microwave oven is specifically designed to heat, cook, or dry food. It is not designed for industrial or laboratory use.
- 7) As with any appliance, close supervision is necessary when used by children.

- 8) Do not operate this appliance if it has a damaged cord or plug. If it is not working properly, or if it has been damaged or dropped.
- 9) This appliance should be serviced only by a qualified service personnel. Contact nearest authorized service facility for examination, repair or adjustment.
- 10) Do not cover or block any openings on this appliance.
- 11) Do not store this appliance outdoors. Do not use this product near water – for example, near a kitchen sink, in a wet basement, near a swimming pool, or similar locations.
- 12) Do not immerse cord or plug in water.
- 13) Keep cord away from heated surfaces.
- 14) Do not let cord hang over edge of table or counter.
- 15) When cleaning surfaces between the door and the microwave that come together upon closing, use only mild, nonabrasive soaps or detergents applied with a sponge or soft cloth.
- 16) To reduce the risk of fire in the microwave cavity:
 - a) Do not overcook food. Carefully attend appliance when paper, plastic, or other combustible materials are placed inside the microwave to facilitate cooking.
 - b) Remove wire twist-ties from paper or plastic bags before placing bag in oven.
 - c) If materials inside the microwave ignite, keep microwave door closed, turn the microwave off and disconnect the power cord, or shut off power at the fuse or circuit breaker panel.
 - d) Do not use the cavity for storage purposes. Do not leave paper products, cooking utensils, or food in the cavity when not in use.
- 17) Liquids, such as water, coffee, or tea are able to be overheated beyond the boiling point without appearing to be boiling. Visible bubbling or boiling when the container is removed from the microwave oven is not always present. **THIS COULD RESULT IN VERY HOT LIQUIDS SUDDENLY BOILING OVER WHEN THE CONTAINER IS DISTURBED OR A UTENSIL IS INSERTED INTO THE LIQUID.**
- 18) This appliance is intended for household use only.

!! SAVE THESE INSTRUCTIONS !!



Important Grounding Instructions

This appliance must be grounded. In the event of an electrical short circuit, grounding reduces the risk of electric shock by providing an escape wire for the electric current. This appliance is equipped with a cord having a grounding wire with a grounding plug. The plug must be plugged into an outlet that is properly installed and grounded.

Three-pronged
(grounding) plug

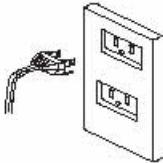

Properly polarized and
grounded outlet

WARNING-Improper use of grounding can result in a risk of electric shock.

Consult a qualified electrician or serviceman if the grounding instructions are not completely understood, or if doubt exists as to whether the appliance is properly grounded and either:

1. If it is necessary to use an extension cord, use only a 3-wire extension cord that has a 3-blade grounding plug, and a 3-slot receptacle that will accept the plug on the appliance. The marked electrical rating of the extension cord shall be equal to or greater than the rating of the appliance, or
2. Do not use an extension cord. If the power supply cord is too short, have a qualified electrician or serviceman install an outlet near the appliance.



PRECAUTIONS TO AVOID POSSIBLE EXPOSURE TO EXCESSIVE MICROWAVE ENERGY

- Do not attempt to operate this microwave oven with the door open because this can result in harmful exposure to microwave energy. It is important not to break or tamper with the safety interlocks.
- Do not place any object between the microwave oven frame and the door or allow soil or cleaner residue to accumulate on sealing surfaces.
- Do not operate the microwave oven if it is damaged. It is very important that the microwave door closes properly and that there is no damage to the:
 - a) Door (including any dents)
 - b) Hinges and Latches (including broken or loose parts)
 - c) Door seals and Sealing surfaces
- The microwave oven should not be adjusted or repaired by anyone except properly qualified service personnel.

Features and Benefits

- 0.9 cu.ft. 900W Oven Cavity
- Easy-to-use Instructive Talking Programmable Feature
- Interchangeable Voice Language Feature (English/Spanish)
- 10 Power Levels
- Eight Instant Settings for Common Foods
- Five Express Cook One-Touch Settings
- Five Memory Setting Buttons
- Blue Electronic Digital Display with Clock (LED)
- Turntable
- Time Cook
- Time and Weight Defrost
- Remind Signal
- Kitchen Timer

Specifications

Model.....	87108
Power Source.....	120V ~ 60Hz
Power Consumption.....	1450 W
Maximum Output.....	900 W
Oven Capacity.....	0.9 Cu.ft.
Turntable Diameter.....	12.4 inches
External Dimensions.....	20.1 x 17 x 11.2 inches
Net Weight.....	30.5 lbs

How to test for a microwave-safe dish:

To determine if a dish is microwave safe, place the dish in the microwave along with a glass measuring cup filled with one cup of water. Microwave for one minute on high and then carefully feel the dish. If it is warm, it is not microwave safe.

Arcing – The microwave term for sparks in the oven. Caused by:

- Metal or foil touching the side of the microwave
- Upturned edges of foil not wrapped around the food
- Metals in the microwave such as twisty ties, meat pins or metal rimmed dishes
- Recycled paper towels in the microwave that contain small flecks of metal

Materials for use in microwave

To avoid arcing and other hazards, follow these instructions for the use of safe materials in the microwave.

Browning dish	Follow manufacturer's instructions. The bottom of browning dish must be at least 3/16 inch (0.5 cm) above the turntable. Incorrect usage may cause the turntable to break.
Dinnerware	Microwave-safe only. Follow manufacturer's instructions. Do not use cracked or chipped dishes.
Glassware	Heat-resistant microwave oven glassware only. Make sure there is no metallic trim. Do not use cracked or chipped dishes.
TEMO cooking bags	Follow manufacturer's instructions. Do not close with metal tie. Make slits to allow steam to escape.
Paper plates/cups	Use for short-term cooking/warming only. Do not leave microwave oven unattended while cooking.
Paper towels	Use to cover food for reheating and absorbing fat. Use with supervision for short-term cooking only.
Parchment paper	Use as a cover to prevent splattering or a wrap for steaming.
Plastic	Microwave-safe only. Follow the manufacturer's instructions. Boiling bags and tightly closed plastic bags should be slit, pierced or vented as directed by package. Due to various manufacturers you may receive varying performance results when using a bacon tray.
Plastic wrap	Microwave-safe only. Use to cover food during cooking to retain moisture. Do not allow plastic wrap to touch food.
Thermometers	Microwave-safe only.
Wax paper	Use as a cover to prevent splattering and retain moisture.

Materials to avoid in microwave

- Metal pans and bake ware
- Recycled paper products
- Non-heat-resistant glass
- Food storage bags
- Dishes with metallic trim
- Brown paper bags
- Non-microwave-safe-plastics (margarine tubs)
- Metal twist-ties

Setting up your microwave

Installation:

1) Remove all packing materials and accessories. Examine the microwave oven for any damage such as dents or broken door. Do not install if microwave oven is damaged.

2) Select a level surface that provides enough open space for ventilation. Allow for 3 inches of open space next to the sides and back of the microwave. Allow for 12 inches of open space above the microwave, and do not remove the legs from the bottom of the microwave.

3) Place the microwave as far away as possible from radios and televisions. Microwave may cause interference to these appliances.

4) Plug the microwave into a standard household outlet. Check the rating label of the microwave to ensure the voltage and frequency are compatible with the outlet.

5) Do not install microwave over a range cook top or other heat-producing appliance. Heat can damage the microwave and void the warranty.

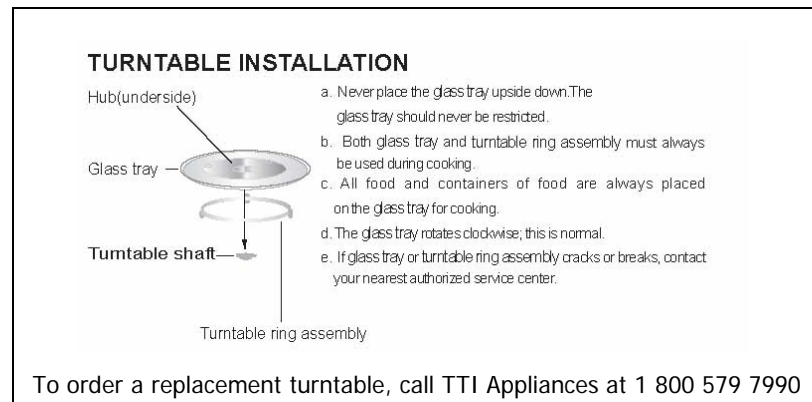
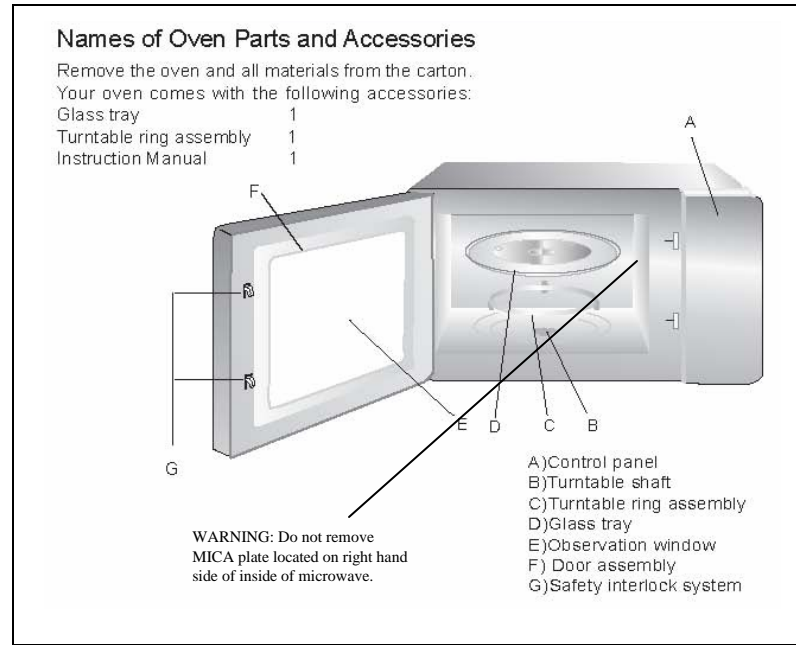

Control Panel Operation

Control Panel

Display Window

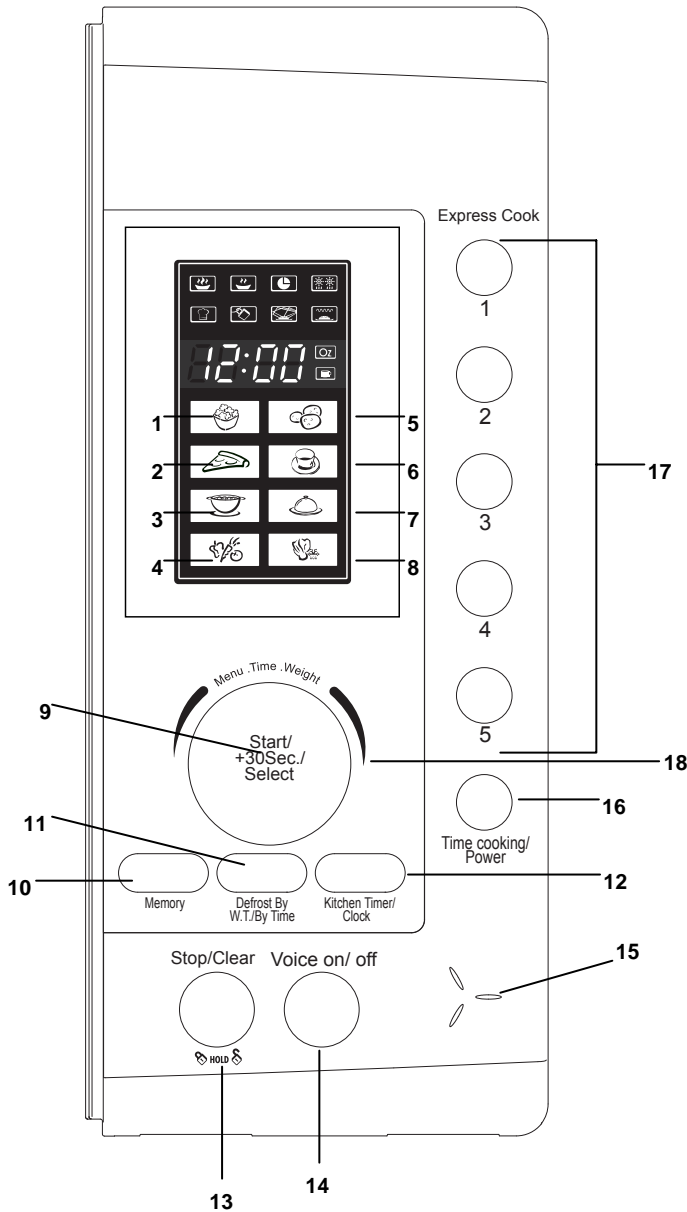

Display Window Icons*

- (1) High Power
- (2) Low Power
- (3) Time
- (4) Defrost
- (5) Auto Cook
- (6) Lock function for children
- (7) Microwave
- (8) Grill
- (9) Ounce
- (10) Cup

		Page
1	POPCORN	14
2	PIZZA	14
3	SOUP	15
4	FRESH VEGETABLE	15
5	POTATO	14
6	BEVERAGE	14
7	DINNER PLATE	15
8	FROZEN VEGETABLE	15
9	START / +30 SEC / SELECT	13
10	MEMORY	16
11	DEFROST BY WEIGHT / TIME	13
12	KITCHEN TIMER / CLOCK	16
13	STOP / CLEAR / CHILD LOCK: clears all previous settings if pressed before cooking starts. During cooking, press once to stop oven, twice to stop and clear all entries. See page 16 for child lock.	10
14	VOICE ON / OFF	10
15	VOICE SPEAKER	
16	TIME COOKING / POWER	11
17	EXPRESS COOK	13
18	SELECTOR DIAL	10

* Note: Not all icons are used for all models

1. Clock Setting

When the microwave TEMO is plugged into an outlet, the TEMO will say **“TEMO would like to welcome you”** and display **“0:00”**. TEMO will then request to and say **“Set clock, please select hour”**. Using the selector dial choose the correct hour. Press select after correct hour is entered, TEMO will then say **“Please select minutes”**. Using the selector dial choose the correct minutes. Press **“Start”** to finish clock setting and TEMO will say **“Hi, I’m TEMO and I’m ready to cook”**.

2. Voice on/off

TEMO voice setting is defaulted to high volume in English language. User has the option of changing voice volume to either high or low, turning voice off or on and changing language preference to either English or Spanish (French).

1. To change voice volume to **“low”** press **“Voice on/off”** button. TEMO will say **“Voice low”**.
2. To turn voice **“off”** press **“Voice on/off”** button. TEMO will say **“Voice off”**.
3. To turn voice volume to **“high”** press **“Voice on/off”** button. TEMO will say **“Voice high”**.
4. To switch language from English to Spanish (French) press and hold **“Voice on/off”** button for 3 seconds. Follow same procedure to switch language back to English.
5. Follow steps 1 through 3 in Spanish (French) language to turn voice volume to either **“low”**, **“off”** or **“high”**. Follow step 4 to switch language.

3. Selector Dial

Selector dial is used to set time for clock, select minutes and seconds for the following functions: Time Cooking, One-stage cooking, Two-stage cooking, Time Defrost and Kitchen timer. Selector dial is also used to select proper weight for Defrost by Weight function. Eight preset functions for common foods also require the use of selector dial to toggle through, the different presets and choosing of appropriate settings.

Selector dial can be turned clockwise or counter-clockwise. For time selection you increase time by turning selector dial clockwise and decrease time by turning counter-clockwise. Once done turning, push selector dial button in-ward to confirm selection.

4. Child Lock

- 1) Press **“Stop/Clear”** button and hold for 3 seconds TEMO will say **“Child lock on”**. TEMO is now locked and cannot be used.
- 2) To unlock, press and hold **“Stop/Clear”** button for 3 seconds TEMO will say **“Child lock off”**. TEMO is now unlocked.

5. Stop/Clear

- 1) To stop TEMO at any point during cooking, press **“Stop/Clear”** once TEMO will say **“Stop”**.
- 2) To clear the display window, press **“Stop/Clear”** again and TEMO will say **“Clear”**.

6. Time Cooking / Power

Press Time Cooking/Power button once to cook by time. Press Time cooking/Power button twice to select power level. Ten power levels are available. Turn selector dial to scan through the different Power levels.

1. Push Time cooking/Power button once and TEMO will say **"Time cooking, please select minutes"**. User can select minutes by turning selector dial. User can choose 1 through 30 minutes in increments of 1 minute. Minutes 35-95 can be chosen in increments of 5 minutes. Once desired minutes are entered push **"Select"** and TEMO will say **"Please select seconds"**. Select desired seconds by turning selector dial and press **"Start"** once seconds are entered. TEMO will say **"Cooking started"** when **"Start"** is pressed. When cooking is completed TEMO will say **"Cooking finished"**.

2. Push Time cooking/Power button twice and TEMO will say **"Please select power level"**. Using the selector dial user can select level. TEMO default level is 10, if selected it will say **"100 percent"**. If different level is desired turn selector dial to select proper power level and TEMO will say power level chosen (**"90 percent", "80 percent",... "10 percent"**.) LED display will show power levels in the following format: PL10, PL 9, PL 8, PL 7, PL 6, PL 5, PL 4, PL 3, PL 2 and PL 1. Correct icon will flash while in use (high power or low power). After power level is selected push **"Select"** and TEMO will say **"Please select minutes"**. User can select minutes by turning selector dial. User can choose 1 through 30 minutes in increments of 1 minute. Minutes 35-95 can be chosen in increments of 5 minutes. Once desired minutes are entered press **"Select"** and TEMO will say **"Please select seconds"**. User can select seconds by turning selector dial and press **"Start"** once seconds are entered. TEMO will say **"Cooking started"** when **"Start"** is pressed. When cooking is completed TEMO will say **"Cooking finished"**.

Level	10	9	8	7	6	5	4	3	2	1
Power	100%	90%	80%	70%	60%	50%	40%	30%	20%	10%

High level indicator lights up and will flash while in operation

Low level indicator lights up and will flash while in operation

7. One-stage cooking

To cook food at only one power level:

1. User can select power level to use by pressing "Time Cooking/Power" button twice and TEMO will say **"Please select power level"**.
2. Using the selector dial user can select level. TEMO default level is 10, if selected it will say **"100 percent."** If different level is desired turn selector dial to select proper power level and TEMO will say level chosen (**"90 percent", "80 percent",... "10 percent"**). LED display will show power levels in the following format: PL10, PL 9, PL 8, PL 7, PL 6, PL 5, PL 4, PL 3, PL 2, and PL 1. Correct icon will flash while in use (high power or low power).
3. After power level is selected press "Select" and TEMO will say **"Please select minutes"**. User can select minutes by turning selector dial . User can choose 1 through 30 minutes in increments of 1 minute. Minutes 35 to 95 can be chosen in increments of 5 minutes.
4. Once desired minutes are entered press "Select" and TEMO will say **"Please select seconds"**. User can select seconds by turning selector dial . Press "Start" once desired seconds are entered.
5. TEMO will say **"Cooking started"** when "Start" is pressed. When cooking is completed TEMO will say **"Cooking finished"**.

8. Two-stage cooking

To cook food at one power level, and then at a second power level immediately after:

1. Press "Time cooking/Power" twice and TEMO will say **"Please select power level"**. Using the selector dial to select power level desired. TEMO will say **"XX percent"**.
2. Using selector dial user can select level. TEMO default level is 10, if selected it will say **"100 percent"**. If different level is desired turn selector dial to select proper power level and TEMO will say level chosen (**"90 percent", "80 percent", ... "10 percent"**). LED display will show power levels in the following format: PL10, PL 9, PL 8, PL 7, PL 6, PL 5, PL 4, PL 3, PL 2 and PL 1. Correct icon will flash while in use (high power or low power).
3. Press "Select" and TEMO will say **"Please select minutes"**. User can select minutes for stage 1 cooking by turning selector dial.
4. Once desired minutes are entered press "Select" and TEMO will say **"Please select seconds"**. User can select desired seconds for stage 1 cooking by turning selector dial. **Do not press "SELECT"**.
5. Press "Time cooking/Power" twice for stage 2 cooking and TEMO will say **"Please select power level"**. Using the selector dial select power level desired. See step 2 above.
6. Press "Select" and TEMO will say **"Please select minutes"**. User can select minutes for stage 2 cooking by turning selector dial.

7. Once desired minutes are entered press "Select" and TEMO will say "**Please select seconds**". User can select desired seconds for stage 2 cooking by turning selector dial.

8. Press "Start" and TEMO will say "**Cooking started**". Once cooking is finished TEMO will say "**Cooking finished**". You will hear a beep sound when stage 1 finishes and stage 2 begins.

9. Express Cook

Buttons 1-5 on the control panel are for express cooking. To cook food at 100% power with the touch of a button, press "1" for one minute, "2" for 2 minutes, and so on up until "5" for 5 minutes.

TEMO will say "**One minutes express cook**" if 1 is pressed, "**Two minutes express cook**" if 2 is pressed, "**Three minutes express cook**" if 3 is pressed, "**Four minutes express cook**" if 4 is pressed and "**Five minutes express cook**" if 5 is pressed.

10. +30 SEC

The "+30 SEC" button can be used to set the time for cooking or for adding on time while food is already cooking. To set the time for cooking, press "+30 SEC" button repeatedly to increase the time to your desired cooking time. Press "+30 SEC" button during cooking to increase the cooking time by 30 seconds. TEMO will say "**30 seconds added**" every time it is entered. The maximum amount of time that can be added is 95 minutes.

11. Defrost by Weight Function

1) Press "Defrost by W.T./By Time" button once TEMO will say "**Defrost by weight, please select weight**".

2) Using the selector dial enter the weight in ounces (4-100 oz). Press "Start/+30 Sec/Select" and TEMO will say "**Defrost started**".

3) When defrost time elapses TEMO will say "**Defrost finished**".

12. Time Defrost Function

1) Press "Defrost by W.T./By Time" button twice to defrost by time. TEMO will say "**Defrost by time, please select minutes**", using the selector dial enter desired minutes. Minutes 1 through 30 can be chosen in increments of 1 minute. Minutes 35 to 95 can be chosen in increments of 5 minutes. Once desired minutes are entered push "Select" and TEMO will say "**Please select seconds**". Select desired seconds by turning selector.

2) Press "Start" once seconds are entered, TEMO will say "**Defrost started**". Once time has elapsed TEMO will say "**Defrost finished**".

13. Popcorn



-Do not use this button if the size of the popcorn bag is less than 1.75 oz. (50 grams).

- 1) Using the selector dial toggle to "POPCORN" icon on LED display, TEMO will say "**Popcorn**" then press "Select" button. TEMO will ask "**Please select weight**".
- 2) Using the selector dial select popcorn bag size: 1.75 oz, 3.0 oz or 3.5 oz. LED will display "1.75 oz", "3.0 oz" or "3.5 oz". Once bag size is selected press "Start" TEMO will say "**Cooking started**". Once cooking time has elapsed TEMO will say "**Cooking finished**".

Always follow manufacturer's instructions for popcorn if the cooking time for the pre-set buttons differs from the manufacturer's recommended time. Never leave popcorn cooking unattended. Place popcorn bags on center of turntable glass. If bag moves during cooking please stop TEMO and place bag in center of glass and resume cooking.

14. Potato



- 1) Using the selector dial toggle to "Potato" icon on LED display, TEMO will say "**Potato**" then press "Select" button. TEMO will ask "**Please select pieces**".
- 2) Using the selector dial choose amount of pieces (1 pc is about 230g). LED will display "1" for one potato (approximately 230 grams), "2" for 2 potatoes (approximately 460 grams), "3" for 3 potatoes (approximately 690 grams).
- 3) Once desired pieces are entered press "Start" TEMO will say "**Cooking started**". Once cooking time has elapsed TEMO will say "**Cooking finished**".

15. Pizza



- 1) Using the selector dial toggle to "Pizza" icon on LED display, TEMO will say "**Pizza**" then press "Select" button. TEMO will ask "**Please select slices**".
- 2) Using the selector dial choose number of slices to cook. LED will display "1" for 1 slice (approximately 3 oz./85grams), "2" for 2 slices (approximately 6 oz./170 grams), "3" for 3 slices (approximately 9 oz./255 grams).
- 3) Once amount of slices are entered press "Start" TEMO will say "**Cooking started**". Once the cooking time has elapsed TEMO will say "**Cooking finished**".

16. Beverage



- 1) Using the selector dial toggle to cup icon on LED display, TEMO will say "**Beverage**" then press "Select" button. TEMO will ask "**Please select cups**".
- 2) Using the selector dial choose amount of cups. LED display will show "1" for 1 cup (approximately 250 ml), "2" for 2 cups, "3" for 3 cups.
- 3) Once desired cups are entered press "Start" TEMO will say "**Cooking started**". Once the cooking time has elapsed TEMO will say "**Cooking finished**".

17. Soup



- 1) Using the selector dial toggle to "Soup" icon on LED display, TEMO will say "**Soup**" then press "Select" button. TEMO will ask "**Please select weight**".
- 2) Using the selector dial choose weight to cook. LED will display "4.0 oz" (approximately 113 grams), "8.0 oz" (approximately 227 grams), "12 oz" (approximately 340 grams), or "16 oz" (approximately 454 grams).
- 3) Once desired weight is entered press "Start" TEMO will say "**Cooking started**". Once the cooking time has elapsed TEMO will say "**Cooking finished**".

18. Dinner Plate



- 1) Using the selector dial toggle to "Dinner plate" icon on LED display, TEMO will say "**Dinner plate**" then press "Select" button. TEMO will ask "**Please select weight**".
- 2) Using the selector dial choose weight to cook. LED will display "9.0 oz" (approximately 255 grams), "12 oz" (approximately 340 grams), or "18 oz" (approximately 510 grams).
- 3) Once desired weight is entered press "Start" TEMO will say "**Cooking started**". Once the cooking time has elapsed TEMO will say "**Cooking finished**".

19. Fresh Vegetable



- 1) Using the selector dial toggle to "Fresh Vegetable" icon on LED display, TEMO will say "**Fresh vegetable**" then press "Select" button. TEMO will ask "**Please select weight**".
- 2) Using the selector dial choose weight to cook. LED will display "4 oz" (approximately 113 grams), "8 oz" (approximately 227 grams), or "16 oz" (approximately 454 grams).
- 3) Once desired weight is entered press "Start" TEMO will say "**Cooking started**". Once the cooking time has elapsed TEMO will say "**Cooking finished**".

20. Frozen Vegetable



- 1) Using the selector dial toggle to "Frozen Vegetable" icon on LED display, TEMO will say "**Frozen vegetable**" then press "Select" button. TEMO will ask "**Please select weight**".
- 2) Using the selector dial choose weight to cook. LED will display "4 oz" (approximately 113 grams), "8 oz" (approximately 227 grams) or "16 oz" (approximately 454 grams).
- 3) Once desired weight is entered press "Start" TEMO will say "**Cooking started**". Once the cooking time has elapsed TEMO will say "**Cooking finished**".

21. Memory Function

There are five memory settings which you can use to save your own cooking instructions:

- 1) Press "Memory" one to five times to select one of the five memory settings. TEMO will say and indicate which Memory setting is being selected ("**Memory one**", "**Memory two**", "**Memory three**", "**Memory four**" or "**Memory five**").
- 2) Follow one of the instructions (A,B,C) below:
 - a) For one-stage cooking follow the instructions on page 12 of manual.
 - b) For two-stage cooking follow the instructions on page 12 of manual.
 - c) To use Time Defrost follow the instructions on page 13 of manual.
- 3) Press "Memory" to save your setting.
- 4) To cook food using the memory settings, press "Memory" one to five times to select the desired memory setting, then press "Start". TEMO will say "**Cooking started**". When time has elapsed TEMO will say "**Cooking finished**".

22. Clock Functions

To determine the time in the middle of cooking, press "Clock". The time will display for three seconds.

To determine the power level while cooking, press the "Power" button and the current power level will be displayed.

23. Kitchen Timer

- 1) Press "Kitchen Timer/Clock" button once to set kitchen timer, TEMO will say "**Set kitchen timer, please select minutes**".
- 2) Using the selector dial enter minutes. User can choose minutes 1-30 in increments of 1 minute. Minutes 35-95 can be chosen in increments of 5.
- 3) Once desired minutes are entered press "Select" TEMO will say "**Please select seconds**". Using the selector dial enter desired seconds.
- 4) Press "Start" TEMO will say "**Kitchen timer started**".
- 5) When countdown ends, TEMO will beep five times.

Care and Cleaning

- Keep the inside of the TEMO clean. Food particles and liquid stains that stick to the TEMO walls can hinder the operation of the microwave.
- Clean up spilled liquids immediately with a damp towel and mild soap. Avoid abrasive cleaners.
- To loosen food particles and stains, heat up two cups of water with lemon juice at high power for four minutes, or until boiling. Let stand in the microwave for three minutes before cleaning.
- Remove the glass turntable from the microwave while cleaning. Do not put the turntable directly in water immediately after cooking, or it may break. Wash the turntable in warm, soapy water or in the dishwasher.
- The outside of the microwave can be cleaned with damp towel and mild soap. Do not let water seep into any openings or damage may occur to the microwave.



Troubleshooting

Problem	Possible Causes	What to do
1. Dim TEMO Light	1a. In low power cooking, TEMO light may become dim 1b. Reflective door may make light seem dim	1a. This is normal 1b. This is normal
2. Steam accumulating on door or hot air coming out of vents during cooking	2. Food releases steam during cooking	2. This is normal
3. TEMO is started accidentally with no food in it	3. Microwave is started accidentally with no food in it	3. No damage will occur if the microwave runs for less than 20 seconds
4. Interference with TV reception	4. Microwave operation may affect radio and TV reception	4. This is normal
5. Microwave will not start	5a. Power cord not plugged in tightly 5b. A fuse is blown or circuit breaker trips 5c. Problem with electrical outlet	5a. Unplug, wait 10 seconds, then plug in again 5b. Replace fuse or reset circuit breaker 5c. Consult with professional electrician
6. Glass turntable makes noise during operation	6. The microwave cavity is dirty	6. Clean the microwave and Turntable rest with warm water and microwave-safe cleaning products
7. Popcorn is over-cooked or under-cooked with "Popcorn" Easy Button	7. Incorrect power level selected for size of popcorn bag	7. Refer to page 12 for "Popcorn" Button instructions. Always follow manufacturer's instructions for popcorn if the cooking time for the pre-set buttons differs from the manufacturer's recommended time. Never leave popcorn cooking unattended.
8. One of the display icons begins flashing when the microwave isn't cooking	8. A cooking function was accidentally activated	8. Press "Stop/Clear" button

LIMITED 1-YEAR WARRANTY

What does this warranty cover?

- Any defect in materials or workmanship in the manufactured product

What does this warranty not cover?

- Service trips to your home to teach you how to use the product.
- Improper installation.
- Failure of the product if it is abused, misused, altered or used in any manner not in accordance with manufacturer's instructions.
- Products that are used for a commercial purpose.
- Replacement of house fuses or resetting of circuit breakers.
- Damage to the product caused by accident, fire, floods or acts of God.
- Any service to the product
- The glass turntable.
- **Incidental or consequential damage caused by possible defects with this appliance, its installation or repair.**

For how long after the original purchase?

- One (1) year.

How do I make a return?

Return to the retailer from which it was purchased, along with a copy of the store receipt within the given period of time allowed for returns by the retailer (i.e. 90 days). After this period of time, contact TTI Appliances at 1 800 579 7990.

How does state or province law relate to this warranty?

-This warranty is extended to the original purchaser only for products purchased for household use within the country of purchase. **Some states and provinces do not allow the exclusion or limitation of incidental or consequential damages. This warranty gives you specific legal rights, and you may also have other rights which vary from state to state or province to province.**

-Exclusion of implied warranties: Except where prohibited or restricted by law, there are no warranties, whether express, oral or statutory which extend beyond the description on the face hereof, including specifically the implied warranties of merchantability or fitness for a particular purpose.

Warrantor: TTI Appliances, Los Angeles, CA 90025

Consumer Support:

Phone: 1-800-488-5080 (Monday – Friday 8:00 AM – 5:00 PM ET)

Email: support@hb-microwaves.com

On the web: www.hb-microwaves.com

To order replacement turntables:

Phone: 1-800-579-7990

Email: support@hb-microwaves.com

Please complete and return warranty registration card.