



SATA 4 Port PCI Adaptor with RAID RC209
User Manual



Content

• Feature highlights	01
• Package contents	01
• System requirement	01
• Magic Switch introduction and jumper setting	02
• Step by step photo installation of Magic Switch	03
• Hardware installation	05
• Important message for user	06
• RAID introduction	
• RAID 0	06
• RAID 1	09
• RAID 0+1	10
• RAID 5 (optional)	11
• BIOS configuration	14
• Driver installation	
• Quick guide	14
• Detail guide	17

Sil 3114 SATA PCI Card

Feature Highlights

- Silicon Image Sil3114 SATA controller chip
- Compliant with PCI Specification, Rev. 2.3, 32bit, 33/66Mhz
- Compliant with Serial ATA 1.0 specification
- Provides four independent channels to support up to four Serial ATA drives
- Supports RAID0(striping), RAID1(mirroring), RAID5(Parity RAID), RAID 0+1 (mirroring+striping) and Concatenation modes
- HDD functions normally when not in RAID sets (un-RAID mode)
- Supports SATA up to 150MB/Sec
- Supports Windows® 98SE, Me, 2000, XP/2003 32/64 bit
- Connectors : 4 x internal SATA connectors, 2 x external SATA connectors

Package Contents

- 1x Serial ATA 4-Channel RAID PCI HD controller
- 1x Driver CD
- 2x SATA Data Cables & 2 x SATA Power Cables
- 1x Manual
- 1x Low profile bracket

System Requirements

- Pentium-class computer with one available PCI slot
- Windows® 98SE, ME, 2000, XP/2003 32/64 bit

Magic Switch introduction and jumper setting

Before installing the Sil 3114 SATA PCI Card, please see the photo below which shows all the ports & jumpers on this PCI Card.

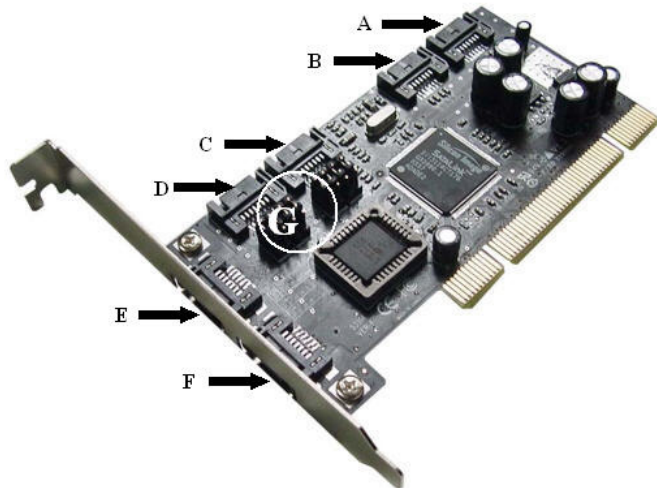

A	SATA Connector 1 (internal)
B	SATA Connector 2 (internal)
C	SATA Connector 3 (internal)
D	SATA Connector 4 (internal)
E	SATA Connector 5 (external)
F	SATA Connector 6 (external)
G	Jumpers

IDE/RAID: Jumper Settings (Default mode as below : 2-3 close)

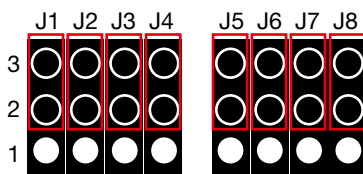

Jumper Settings

JP	Description	Active port
J1-J4	1-2 close	Enable SATA Connector 5
	2-3 close	Enable SATA Connector 4
J5-J8	1-2 close	Enable SATA Connector 6
	2-3 close	Enable SATA Connector 3

Step by step photo installation of Magic Switch

1. There are six SATA ports in RC209 RAID adapter. We named these ports character A through F. Ports A to D are internal SATA ports and E to F are external SATA ports. By changing the jumper setting on RC209 that allows you to utilize 4 ports of this card. Please reference our photos below for the proper jumper setting. Port A and B are always active. With different jumper setting you can active port C, D, E and F by referencing the following photos.

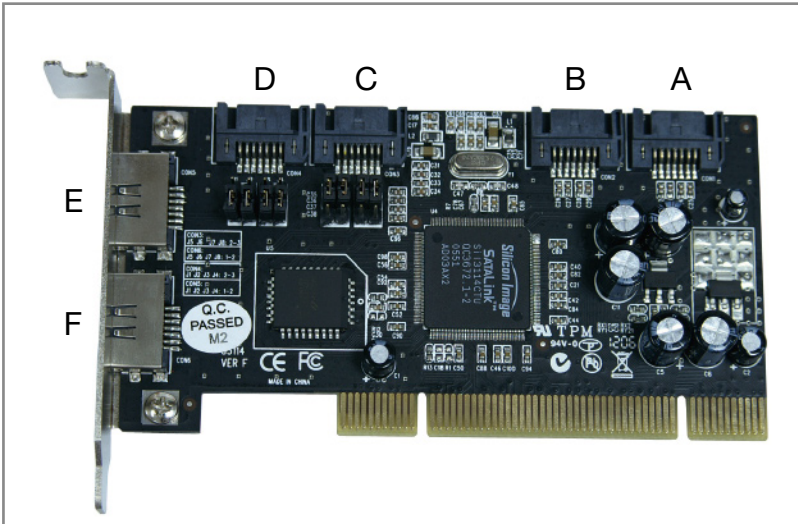

2. Available port setting

- *Jumper setting for 1 pin and 2 pin close
 - connect pin 1 and 2 on J1, J2, J3 and J4.
- *Jumper setting for 2 pin and 3 pin close
 - connect pin 2 and 3 on J5, J6, J7 and J8.

3. ○ Active ✕ Inactive

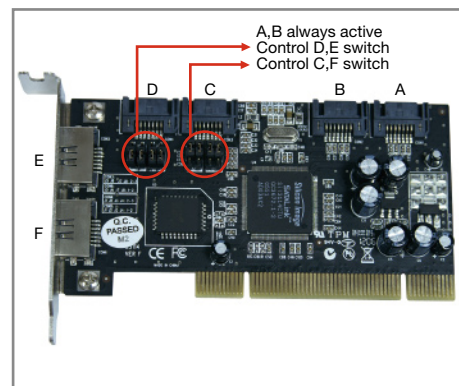
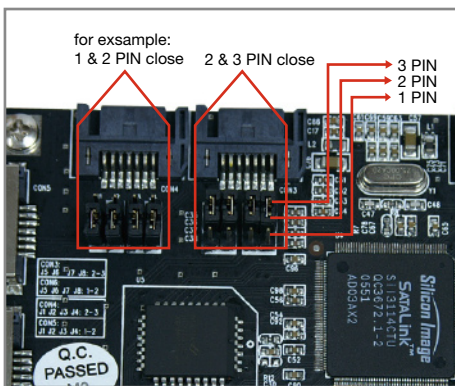

Mode 1 (Default) - ABCD Active

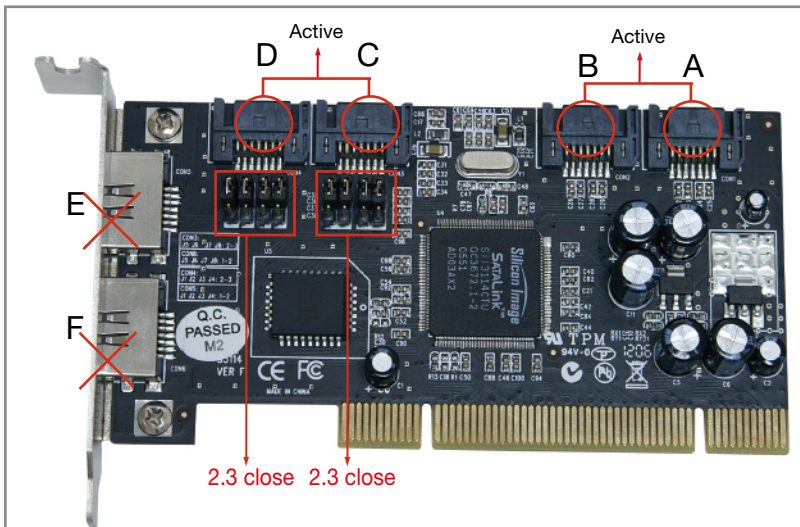

Mode 2 - ABDF Active

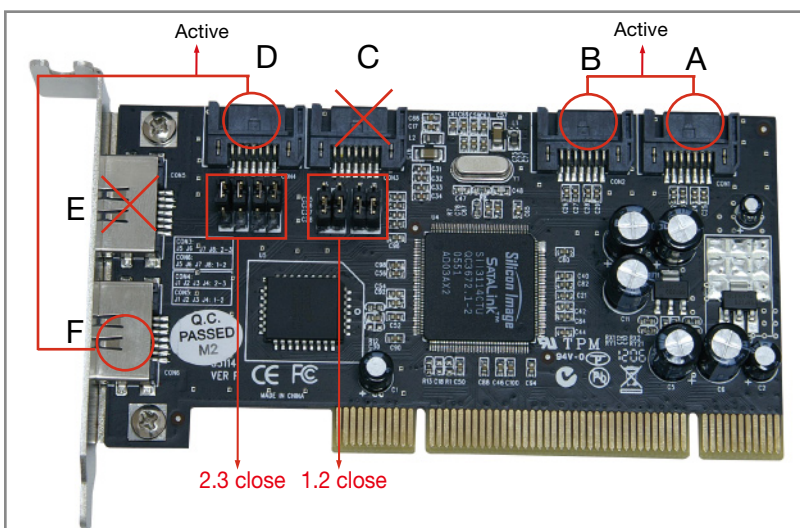

Mode 3 - ABEF Active

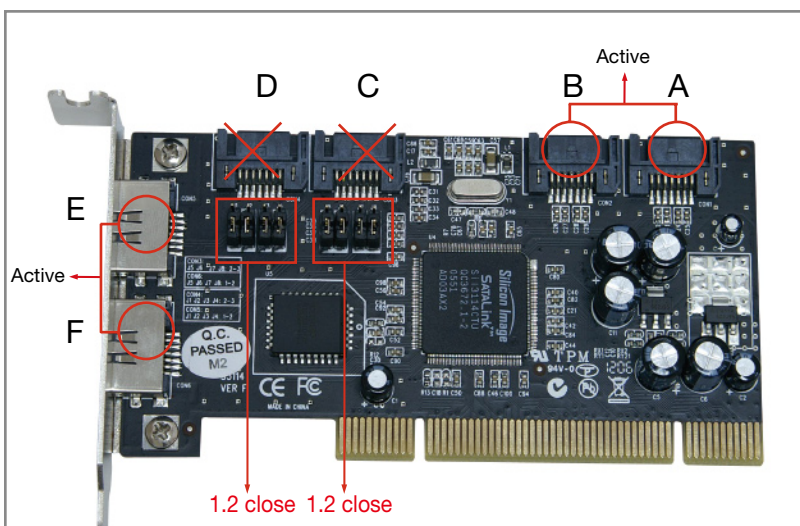

Mode 4 - ABCE Active

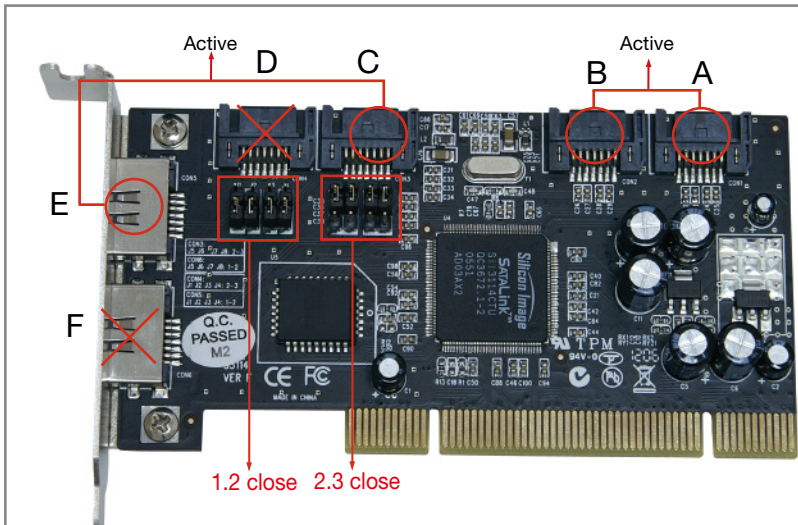

Note: There are six SATA ports in Serial ATA 4-Channel RAID adapter. We named these ports character A through F. Ports A to D are internal SATA ports and E & F are external SATA ports. By changing the jumper setting on the Serial ATA 4-Channel RAID adapter that allows you to utilize 4 ports of this card at the same time. Please set which port to work by jumper setting. By default, Port A, B, C and D are working.

Hardware Installation

1. Turn Off the power to your computer and any other connected peripheral devices.
2. Unplug the power cord from the back of the computer.
3. Remove your computer's cover.
4. Remove the slot bracket from an available PCI slot.
5. To install the card, carefully align the card's bus connector with the selected PCI slot on the motherboard. Push the board down firmly, but gently, until it is well seated.
6. Replace the slot bracket's holding screw to secure the card.

Device Connection

The Serial ATA 4-Channel RAID adapter is a four channel Serial ATA controller that supports up to four Serial ATA hard disk drives. It is recommended to use identical hard drives for all RAID configurations.

1. Install your hard disk drive(s) in chassis.
2. Connect the Serial ATA hard disk drive to the system power supply using the included Serial ATA power cable.

3. Connect one end of the Serial ATA cable to the hard disk drive.
4. Attach the other end of the Serial ATA cable to the Serial ATA controller on the Serial ATA 4-Channel RAID adapter.
5. Follow the same instructions to connect up to four hard drives. Device connection is now complete.
6. Replace the computer cover and reconnect the power cord.

Important message for user

1. Backup all your data in HD before setting any RAID.
2. New HD connecting to RC-209 is recommended to “initial” and “format” before setting a RAID. Otherwise, PC might find nothing in the system.
3. Please read the PDF file of “SATARAID5-UserGuide_v1.40” for basic RAID knowledge.
4. If you want to boot from correct HD either from motherboard HD or RC-209 HD, please change from BIOS “booting sequence”.
5. Although SATA HD is a “hot swap” design, it is strongly recommended that all users turn off the power before you add any HD to PC.
6. If you want to use RC-212 as a un-RAID card, please do not enter the RAID BIOS and set any RAID set at the beginning of booting. You can jump to P11 “Driver installation” directly to complete the install. The only different is ignoring the step of RAID setting and the driver setting is the same as a RAID card.

RAID Arrays

RAID Arrays are setup in the Serial ATA 4-Channel RAID adapter’s BIOS.

RAID 0 (Striping)

This RAID array to be used on **New/Blank** hard drives. Striping will destroy all existing data on the original hard drive. **Auto Configuration** is recommended. For applications that require custom chunk size, **Manual Configuration** is offered.

Auto configuration (recommended)

The default chunk size is **64k** when selecting **Auto configuration**.

1. As the BIOS boots press **Ctrl+S** or **F4** when prompted to enter the RAID BIOS.

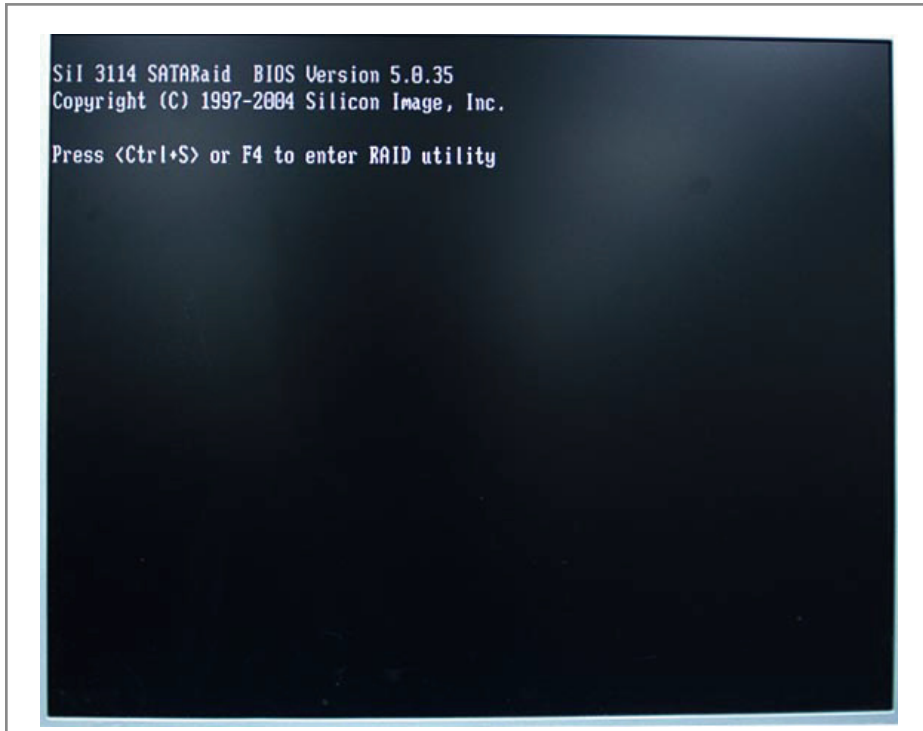

2. At the next screen select **Create RAID Set**, then press **Enter**.

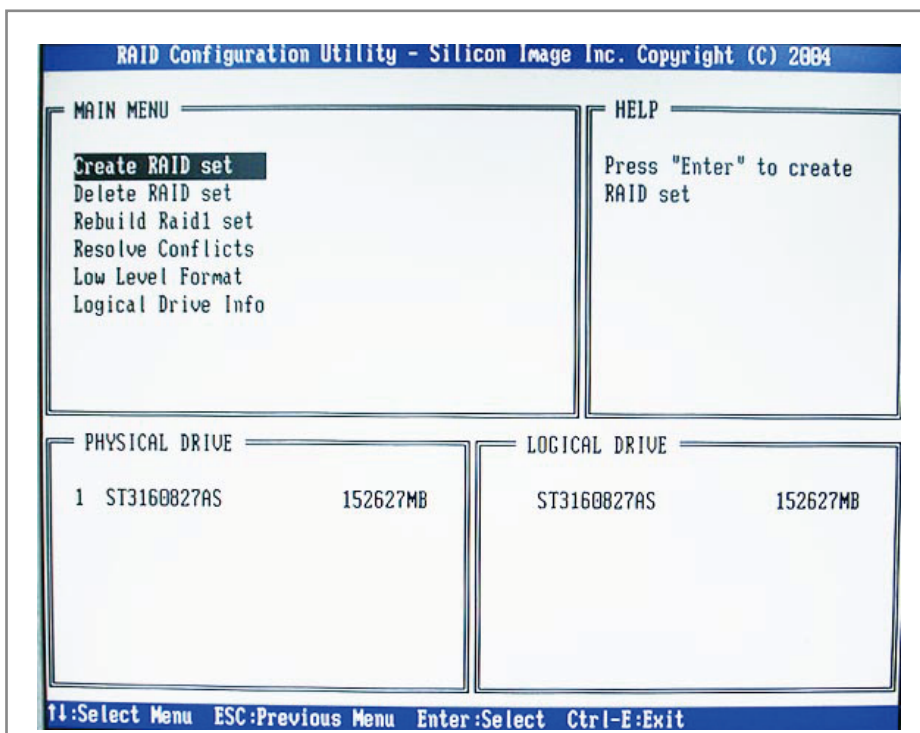

3. Select **RAID0**, then press **Enter**.

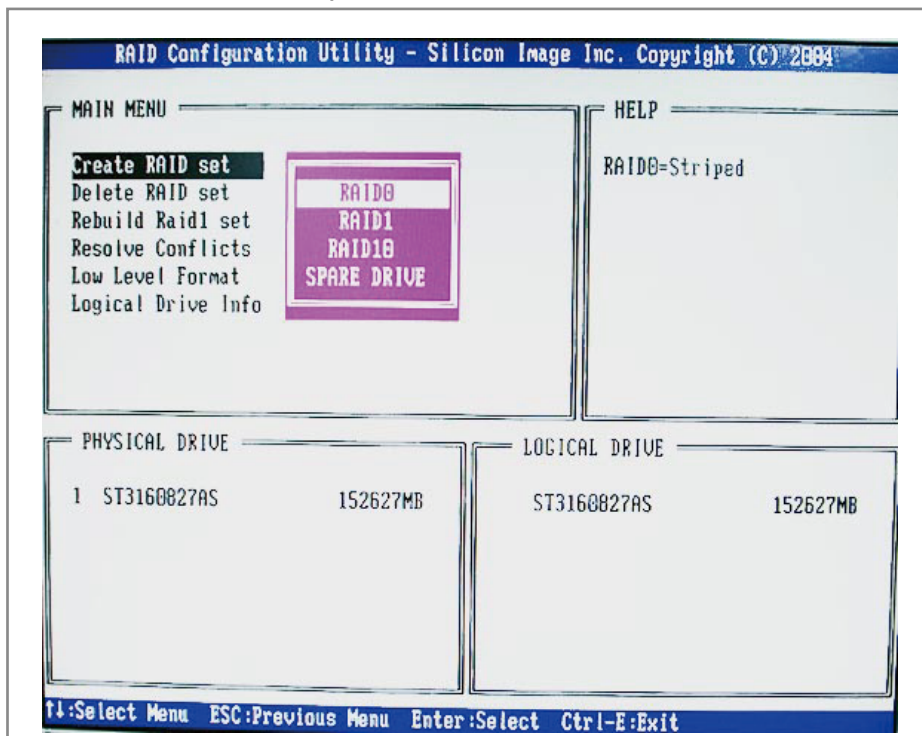

4. Select the number of drives then press **Enter**.
5. Select **Auto configuration**, then press **Enter**.
6. Input the RAID size, press **Enter**.
7. When asked Are You Sure (Y/N)?, press Y to accept.
8. Press **Ctrl+E** to exit the BIOS.
9. When asked **Are you sure to exit (Y/N)?**, press **Y** to exit and reboot.
10. Continue with FDISK and FORMAT steps as if you were installing a conventional hard drive.

Manual configuration

1. As the BIOS boots press **Ctrl+S** or **F4** when prompted to enter the RAID BIOS.
2. At the next screen select **Create RAID Set**, then press Enter.
3. Select **RAID0**, then press **Enter**.
4. Select the number of drives then press **Enter**.
5. Select **Manual configuration** then press **Enter**
6. Select chunk size from **8k, 16k, 32k, 64k** or **128k**, then press **Enter**.
7. Select the **first drive**, press **Enter**.
8. Select the **second drive**, press **Enter**.
9. If applicable select the **3rd** and **4th** drives pressing enter after each selection.
10. Input the RAID size, press **Enter**.
11. When asked **Are You Sure(Y/N)?**, press **Y** to accept.

12. Press **Ctrl+E** to exit the BIOS.
13. When asked Are you sure to exit(Y/N)?, press Y to exit and reboot.
14. Continue with FDISK and FORMAT steps as if you were installing a conventional hard drive.

RAID 1 (Mirror)

For New/Blank Hard Drive

Recommended for all fresh HD without data.

1. As the BIOS boots press **Ctrl+S** or **F4** when prompted to enter the RAID BIOS.
2. At the next screen select **Create RAID Set**, then press **Enter**.
3. At the next screen select **RAID1** then press **Enter**.
4. Select **Auto configuration**, then press **Enter**.
5. Input the RAID size, press **Enter**.
6. When asked **Are You Sure(Y/N)?**, press **Y** to accept.
7. Press **Ctrl+E** to exit the BIOS.
8. When asked **Are you sure to exit(Y/N)?**, press **Y** to exit and reboot.
9. Continue with FDISK and FORMAT steps as if you were installing a conventional hard drive.

For Existing Hard Drives with Data

Recommended for one/two original HD with data to mirror with one/two fresh empty HD

1. As the BIOS boots press **Ctrl+S** or **F4** when prompted to enter the RAID BIOS.
2. At the next screen select **Create RAID Set**, then press **Enter**.
3. At the next screen select **RAID1** then press **Enter**.
4. Select **Manual configuration**, then press **Enter**.
5. Select the Source drive, press **Enter**.
6. Select the Target drive, press **Enter**.
7. Select Create with data copy, then press **Enter**.
8. Select online copy, then press **Enter**.

Note : Selecting **Online Copy** builds the mirror while in Windows. Selecting **Offline Copy** builds the mirror before exiting the RAID BIOS.

9. Input the RAID size, press **Enter**.
10. Press **Ctrl+E** to exit the BIOS.
11. When asked **Are you sure to exit(Y/N)?**, press **Y** to exit and reboot.

Note : If during boot the RAID BIOS reports an **RAID1 set is in Rebuild status**, **The rebuild will continue after boot sequence is complete**, disregard the message, continue booting, and let the Mirror rebuild.

Creating a SPARE Drive

This function is used when you want to backup your data by adding a new HD to RC-209. You can transfer original data to the new adding HD by the following.

When a hard drive failure occurs in a mirror set, the auto-rebuild feature enables a drive designated as **SPARE** to become the new member of the mirror set. After you process this function, your mirror will be rebuilt.

1. During boot press **Ctrl+S** or **F4** to enter the RAID BIOS.
2. Select **Create RAID Set** then press **Enter**.
3. Select **SPARE DRIVE** then press **Enter**.
4. Select the single hard drive then press **Enter**.
5. When asked **Are You Sure(Y/N)?**, press **Y** to accept.
6. Press **Ctrl+E** to exit.
7. When asked **Are you sure to exit(Y/N)**, press **Y** to exit.

The **SPARE** drive will not be used by Windows, however, it remains in the background waiting to rebuild the mirror in the event of a hard drive failure.

Rebuilding a Failed Mirror Set

This function is used when any HD in mirror is failure. Your data is still safety. System will notice and help you rebuild mirror by replacing new HD to the broken part.

When a failure to one member occurs, you will be notified either by the **RAID BIOS** during boot or by the **SATARAID5 GUI** while in Windows. The steps below will guide you in rebuilding a failed mirror set.

1. Replace the failed drive with one of equal or greater capacity, then start the computer.
2. During boot press **Ctrl+S** or **F4** to enter the RAID BIOS.
3. Select **Create RAID Set** then press **Enter**.
4. Select **SPARE DRIVE** then press **Enter**.
5. Select the replacement drive then press **Enter**.
6. When asked **Are You Sure(Y/N)?**, press **Y** to confirm.
7. Press **Ctrl+E** to exit.
8. When asked **Are you sure to exit(Y/N)?**, press **Y** to exit.

RAID 0+1 (Mirroring+Striping)

This RAID array to be used on **New/Blank** hard drives, do not use existing hard drive(s) with data. To create a RAID 0+1 set at least four hard drives are required.

Auto configuration (recommended)

The default chunk size is **64k** when selecting **Auto configuration**.

1. As the BIOS boots press **Ctrl+S** or **F4** when prompted to enter the RAID BIOS.
2. At the next screen select **Create RAID Set**, then press **Enter**.
3. Select **RAID10**, then press **Enter**.
4. Select Auto configuration, then press **Enter**.
5. Input the RAID size, press **Enter**.
6. When asked **Are You Sure(Y/N)?**, press **Y** to accept.
7. Press **Ctrl+E** to exit the BIOS.
8. When asked **Are you sure to exit(Y/N)?**, press **Y** to exit and reboot.
9. Continue with FDISK and FORMAT steps as if you were installing a conventional hard drive.

Manual configuration

1. As the BIOS boots press **Ctrl+S** or **F4** when prompted to enter the RAID BIOS.
2. At the next screen select **Create RAID Set**, then press **Enter**.
3. Select **RAID10**, then press **Enter**.
4. Select the number of drives then press **Enter**.
5. Select **Manual configuration** then press **Enter**.
6. Select chunk size from **8k, 16k, 32k, 64k** or **128k**, then press **Enter**.
7. Select the **first drive**, press **Enter**.
8. Select the **second drive**, press **Enter**.
9. Select the **third drive**, press **Enter**.
10. Select the **fourth drive**, press **Enter**.
11. Select **Create without data copy** then press **Enter**.
12. Input the RAID size, press **Enter**.
13. When asked **Are You Sure(Y/N)?**, press **Y** to accept.
14. Press **Ctrl+E** to exit the BIOS.
15. When asked **Are you sure to exit(Y/N)?**, press **Y** to exit and reboot.
16. Continue with FDISK and FORMAT steps as if you were installing a conventional hard drive.

RAID 5 (Parity)

This RAID array to be used on **New/Blank** hard drives. Striping will destroy existing data on the hard drive. **Auto Configuration** is recommended. For applications that require custom chunk size, **Manual Configuration** is offered.

Auto configuration (recommended)

The default chunk size is **64k** when selecting **Auto configuration**.

1. As the BIOS boots press **Ctrl+S** or **F4** when prompted to enter the RAID BIOS
2. At the next screen select **Create RAID Set**, then press **Enter**.

3. Select **RAID5**, then press **Enter**.
4. Select the number of drives then press **Enter**.
5. Select **Auto configuration**, then press **Enter**.
6. Input the RAID size, press **Enter**.
7. When asked **Are You Sure(Y/N)?**, press **Y** to accept.
8. Press **Ctrl+E** to exit the BIOS.
9. When asked **Are you sure to exit(Y/N)?**, press **Y** to exit and reboot
10. Continue with FDISK and FORMAT steps as if you were installing a conventional hard drive.

Manual configuration

1. As the BIOS boots press **Ctrl+S** or **F4** when prompted to enter the RAID BIOS.
2. At the next screen select **Create RAID Set**, then press **Enter**.
3. Select **RAID5**, then press **Enter**.
4. Select the number of drives then press **Enter**.
5. Select **Manual configuration** then press **Enter**.
6. Select chunk size from **8k, 16k, 32k, 64k** or **128k**, then press **Enter**.
7. Select the **first drive**, press **Enter**.
8. Select the **second drive**, press **Enter**.
9. Select the **third drive**, press **Enter**.
10. If applicable select the **4th drive** pressing enter after each selection.
11. Input the RAID size, press **Enter**.
12. When asked **Are You Sure(Y/N)?**, press **Y** to accept.
13. Press **Ctrl+E** to exit the BIOS.
14. When asked **Are you sure to exit(Y/N)?**, press **Y** to exit and reboot.
15. Continue with FDISK and FORMAT steps as if you were installing a conventional hard drive.

CONCATENATION

This RAID array allows you to use one, two, three or four hard drives to a array. It does not provide any data protection or performance improvement but can be useful for utilizing leftover space on disks.

1. As the BIOS boots press **Ctrl+S** or **F4** when prompted to enter the RAID BIOS.
2. At the next screen select **Create RAID Set**, then press **Enter**.
3. Select **CONCATENATION**, then press **Enter**.
4. Select the number of drives then press **Enter**.
5. Select the **first drive**, press **Enter**.
6. If applicable select the **2nd, 3rd, 4th drive** pressing enter after each selection.
7. When asked **Are You Sure(Y/N)?**, press **Y** to accept.
8. Press **Ctrl+E** to exit the BIOS.

9. When asked **Are you sure to exit(Y/N)?**, press **Y** to exit and reboot.
10. Continue with FDISK and FORMAT steps as if you were installing a conventional hard drive.

Deleting RAID Arrays

1. As the BIOS boots press **Ctrl+S** or **F4** when prompted to enter the RAID BIOS.
2. Select **Delete RAID Set**, then press **Enter**.
3. Select the RAID set then press **Enter**.
4. When asked **Are You Sure(Y/N)?**, press **Y** to confirm.

Resolving Conflicts

When a RAID set is created, then metadata written to the disk includes drive connection information. If, after a disk failure, the replacement disk was previously part of a RAID set (or used in another system), it may have conflicting metadata. If so, this will prohibit the RAID set from being either created or rebuilt, in order for the RAID set to function properly, this old metadata must be first overwritten with the new metadata. To resolve this, from the main BIOS window select **Resolve Conflicts**, then press **Enter**, the correct metadata, including the correct drive connection information, will be written to the replacement disk.

Low Level Format

Low Level Format is build into the RAID BIOS to make it more convenient to erase the entire contents of a hard disk drive, including data, drive and partition information. The Low Level Format utility works on single hard drive only, before the RAID set is configured.

Logical Drive Info

This menu item allows the display of the assignment of physical drives within a logical set(RAID0, RAID1, etc.). This is display only function.

BIOS Configuration

The Serial ATA 4-Channel RAID adapter BIOS will appear every time your system starts up. If the BIOS doesn't show, please try your controller in another PCI slot. During this (POST) process, the

BIOS will show up and indicate the devices attached to it.

Driver Installation

Quick guide:

1. If you want to add RC-209 to an existing OS, set up RC-209 into a PCI slot. Enter the OS and install RC-209 with driver disk. In this case, PC is booting up by an existing HD connecting to motherboard. After RC-209 is installed complete, you can add HD and set the RAID by RAID BIOS.
2. If you want to add RC-209 to a new PC without any OS, you need to boot the OS from HD connecting to RC-209 instead of motherboard.
 - a. Put the driver (the driver must fit the OS you want to install to the HD) into a floppy disk and keep it in the floppy drive.
 - b. Plug the HD. Turn on PC and press F4 to complete the RAID set. After you complete, save and left the setting.
 - c. Inset Windows installation disk and start the windows installation.
 - d. Press F6 at the beginning as the blue screen scanning.

This will let PC boot from a HD controller instead of motherboard HD.

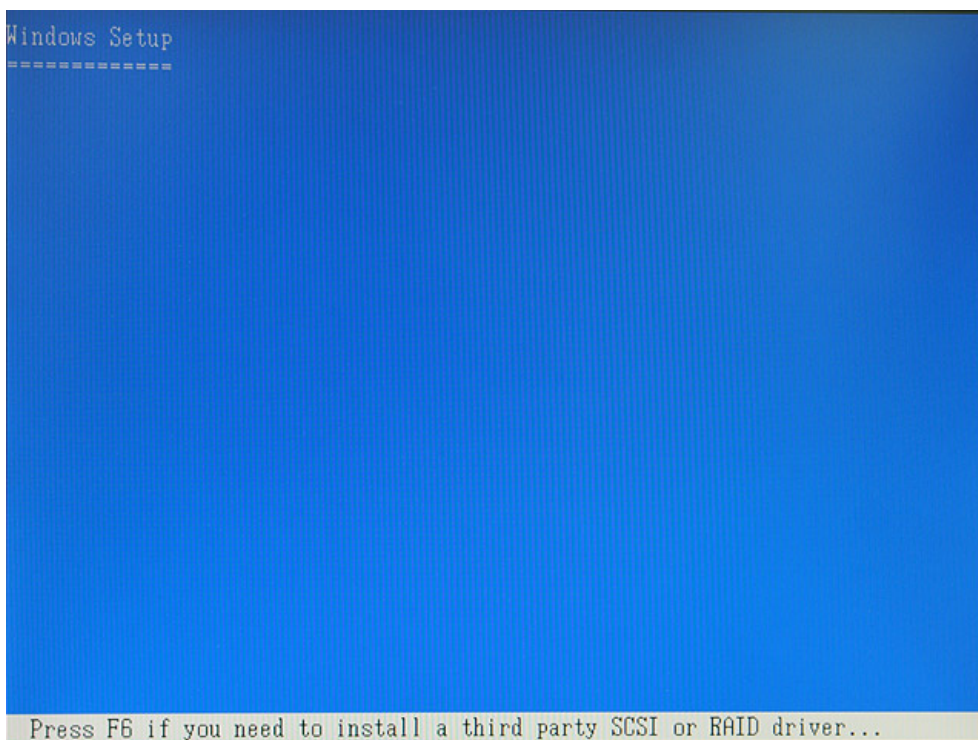

- e. Keep the floppy in floppy drive and follow the installation. Press "S" when the screen shows as the following picture.

```
Windows Setup
=====

Setup could not determine the type of one or more mass storage devices
installed in your system, or you have chosen to manually specify an adapter.
Currently, Setup will load support for the following mass storage device(s):

<none>

* To specify additional SCSI adapters, CD-ROM drives, or special
  disk controllers for use with Windows, including those for
  which you have a device support disk from a mass storage device
  manufacturer, press S.

* If you do not have any device support disks from a mass storage
  device manufacturer, or do not want to specify additional
  mass storage devices for use with Windows, press ENTER.

S=Specify Additional Device  ENTER=Continue  F3=Exit
```

Choose the correct OS for your future system.

```
Windows Setup
=====

You have chosen to configure a SCSI Adapter for use with Windows,
using a device support disk provided by an adapter manufacturer.

Select the SCSI Adapter you want from the following list, or press ESC
to return to the previous screen.

Silicon Image SiI 3114 SATA RAID Controller for Windows XP/Server 2003
Silicon Image SiI 3114 SATA RAID Controller for Windows NT 4.0 and 2000

ENTER=Select  F3=Exit
```

Then choose "Standard PC with C-Step i486".

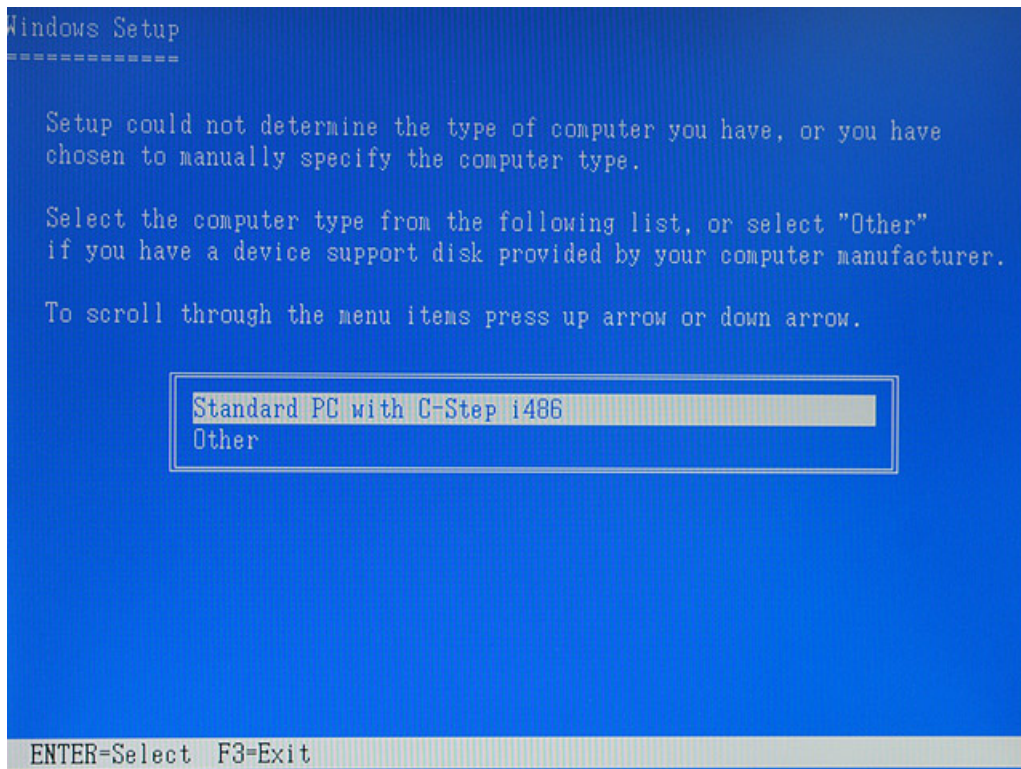

Keep the floppy disk in floppy drive. PC will notice you as below if you take them off from the drive.

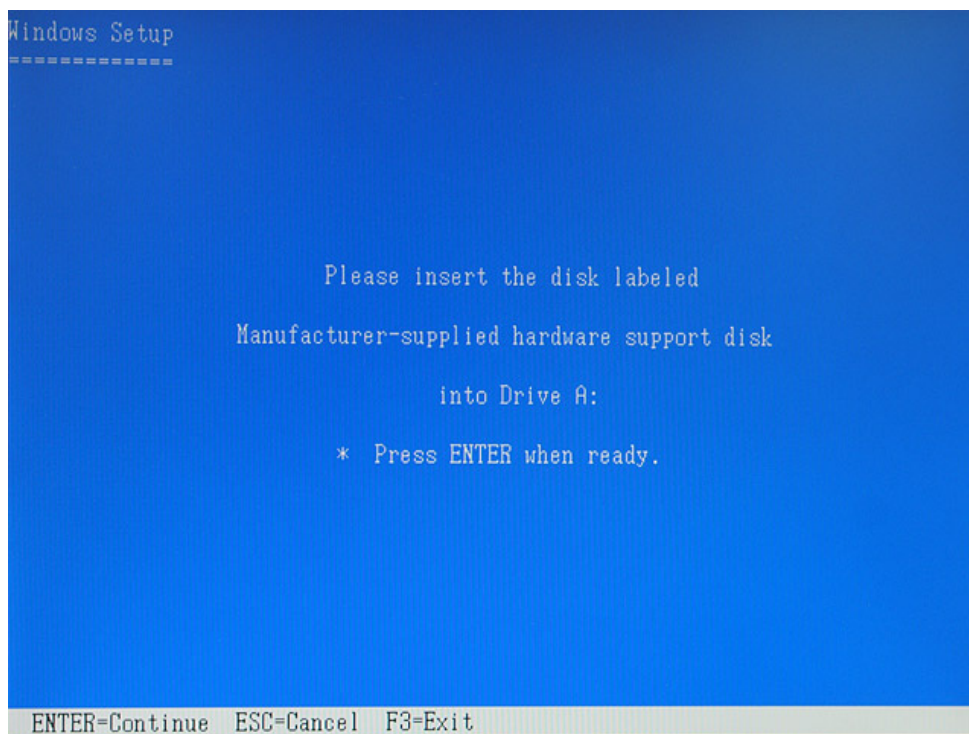

The installation of RC-209 by floppy drive will be completed and the system will detect the HD which now plug on the card.

After you install RC-209 successfully by floppy disk, installation will lead you back to the same screen as below and then press “enter” to left the setting.

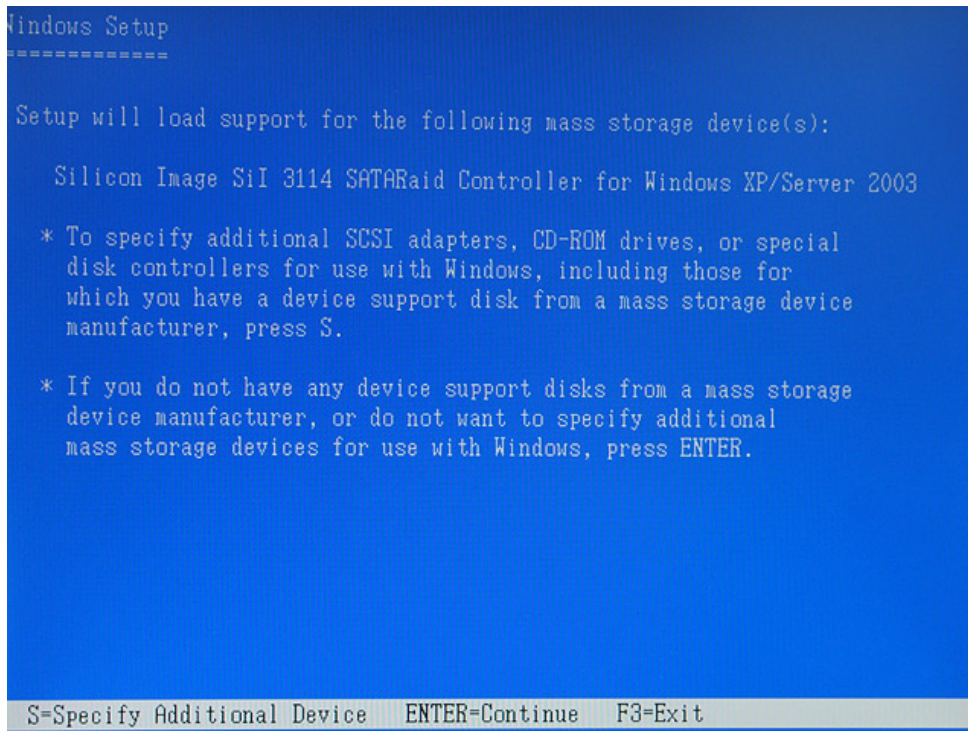

```
Windows Setup
=====

Setup will load support for the following mass storage device(s):

  Silicon Image SiI 3114 SATA RAID Controller for Windows XP/Server 2003

* To specify additional SCSI adapters, CD-ROM drives, or special
  disk controllers for use with Windows, including those for
  which you have a device support disk from a mass storage device
  manufacturer, press S.

* If you do not have any device support disks from a mass storage
  device manufacturer, or do not want to specify additional
  mass storage devices for use with Windows, press ENTER.

S=Specify Additional Device  ENTER=Continue  F3=Exit
```

- f. Once the system can find the HD connecting to RC-209, you can follow the normal steps to complete the Windows installation.
3. If you want to create a mirror with a HD with existing OS and a fresh HD, the data on existing HD will copy to fresh HD and boot as RAID 1. In addition, based on the above situation, if a bootable HD on the RC209 is desired. It means in this case you will boot our computer from RC209 instead of motherboard. Please follow the following instructions.
 - a. Install RC-209 to an existing OS HD connecting to motherboard.
 - b. After RC-209 install complete, turn off PC. Take the original HD off from motherboard and connect to RC-209. Take another fresh HD to connect to RC-209 for setting mirror.
 - c. Turn on PC and enter RAID BIOS to set mirror. Choose “Manual” and then select the original HD as the data source to complete mirror. The copy will take a long time depending on your HD capability. After data copy complete, save and left RAID BIOS.
Important message: If you choose the wrong HD source at the step of “manual”, all your data will be lost.
 - d. Reboot your PC and now you can enter your OS with RAID 1.

Detail guide

For Windows® XP/Server 2003

For New Installation

A new installation requires a floppy disk for the driver installation. To make this floppy disk, copy the contents of the “RC-209\Driver\RAID” folder, found on the driver CD, onto a blank floppy disk then follow the directions below.

1. Setup the RAID Array prior to Windows installation.
2. Follow Microsoft’s Windows installation procedure.
3. Restart the computer when prompted by Windows’ installation.
4. At the Windows Setup screen, press **F6** to install the RAID driver.
5. When prompted, press **S** to specify the location of the driver.
6. Insert the floppy disk, then press **Enter**.
7. Select **Silicon Image Sil 3114 SoftRAID 5 Controller for Windows XP/Server 2003**, then press **Enter**.
8. Press **Enter** to finish driver installation, then follow the on-screen instructions to complete the Windows installation.

Note: If the **Security Alert** warning pops up, click **Yes**. Our driver has passed Microsoft compatibility testing, this message appears during new installation.

For An Existing Installation

1. Setup the RAID Array prior to driver installation and boot up to Windows.
2. At the **Found New Hardware Wizard**:
XP(w/SP1 or earlier)/Server 2003: continue to step #3
XP(w/SP2 or later)/Server 2003(w/SP1 or later): select **No, not this time**, then click **Next**.
3. Insert the driver CD, select **Install the software automatically (Recommended)**, and click **Next**.
4. Click **Finish**.
5. Repeat steps 2-4.

For Windows® 2000

For A New Installation

A new installation requires a floppy disk for the driver installation. To make this floppy disk, copy the contents of the “**RC-209\Driver\RAID**” folder, found on the driver CD, onto a blank floppy disk then follow the directions below.

1. Setup the RAID Array prior to Windows installation.
2. Follow Windows® 2000 installation procedure.
3. Restart the computer when prompted by the installation.
4. At the Windows® 2000 Setup screen, press **F6** to install the RAID driver.
5. When prompted, press **S** to specify the location of the driver.

6. Insert the floppy disk, then press **Enter**.
7. Select **Silicon Image Sil 3114 SoftRaid 5 Controller for Windows 2000**, then press **Enter**.
8. Press **Enter** again to finish driver installation, then follow the on-screen instructions to complete the Windows installation.

For An Existing Installation

1. Setup the RAID Array prior to driver installation and boot up to Windows.
2. At **Found New Hardware Wizard**, click **Next**.
3. Select **Search for a suitable driver for my device(recommend)** then click **Next**.
4. Insert the driver CD, check **CD-ROM drives**, uncheck the other boxes, click **Next**, then click **Next** again.
5. If the **Digital Signature Not Found** message appears, click **Yes**. Our driver has been thoroughly tested for stability and compatibility.
6. Click **Finish**.
7. Repeat steps 2-6.

To Verify Windows® 2000/XP/Server 2003 Installation

1. Right click **My Computer** and click **Manage**.
2. Select **Device Manager**.
3. Double click **SCSI and RAID Controller**, then double click **Silicon Image Sil 3114 SoftRaid 5 Controller** to display driver properties. A message this device is working properly is displayed in the dialog box, the driver has been correctly installed.

For Windows® 98SE

For New Installation

1. Setup the RAID array prior to Windows installation.
2. Follow Microsoft procedures to install Windows® 98SE accordingly.
3. Once Windows has installed and booted, right click **My Computer** and click **Properties**. Select **Device Manager** tab.
4. Double click **PCI RAID controller** listed under **Other Devices**.
5. Select **Driver** tab, then click **Update Driver** button.
6. Please insert the CD driver bound with Serial ATA 4-Channel RAID adapter into your CD-ROM Drive, then click **Next**.
7. Select **Search for the best driver for your device (Recommended)** and click **Next**.
8. Select **Specify a location** and type **D:\RC-209\Driver\RAID** on the field designating the

- file's location. Press **Next** to continue to setup.
(Change **D:** to match your CD-ROM drive letter)
9. Click **Next** again, then **Finish**.
 10. Remove the driver CD, close all open Windows, then restart Windows to complete the installation.

For An Existing Installation

1. Setup the RAID Array prior to driver installation and boot up to Windows.
2. At the **Found New Hardware Wizard** window pop-up, click **Next** to continue.
3. Please insert the CD driver bound with Serial ATA 4-Channel RAID adapter into your CD-ROM Drive, then click **Next**.
4. Select **Search for the best driver for your device (Recommended)** and click **Next**.
5. Select **Specify a location** and type **D:\RC-209\Driver\RAID** on the field designating the file's location. Press **Next** to continue to setup.
(Change **D:** to match your CD-ROM drive letter)
6. Click **Next** again, then **Finish**.
7. Remove the driver CD, close all open Windows, then restart Windows to complete the installation.

For Windows® Me

For New Installation

1. Setup the RAID array prior to Windows installation.
2. Follow Microsoft procedures to install Windows® Me accordingly.
3. Once Windows has installed and booted, right click **My Computer** and click **Properties**.
Select **Device Manager** tab.
4. Double click **PCI RAID controller** listed under **Other Devices**.
5. Select **Driver** tab, then click **Update Driver** button.
6. Please insert the CD driver bound with Serial ATA 4-Channel RAID adapter into your CD-ROM Drive, then click **Next**.
7. Select **Automatic search for a better driver (Recommended)**, then click **Next**.
8. Click **Finish**, remove the CD, close all open Windows, then restart Windows to complete the installation.

For An Existing Installation

1. Setup the RAID Array prior to driver installation and boot up to Windows.
2. At the **Add New Hardware Wizard**, insert the CD driver bound with Serial ATA 4-channel RAID adapter into your CD-ROM Drive, select **Automatic search for a better driver (Recommended)**, then click **Next**.

3. Click **Finish**.
4. Remove the driver CD, close all open Windows, then restart Windows to complete the installation.

To Verify Windows® 98SE/Me Installation

1. Right click **My Computer**, click **Properties**, then click **Device Manager**.
2. Double click **SCSI Controllers**, **Silicon Image Sil 3114 SoftRaid 5 Controller** should be displayed.
3. Highlight **Silicon Image Sil 3114 SoftRaid 5 Controller** and click **Properties**.
A message this device is working properly is displayed in the dialog box, the driver has been correctly installed.

Thank you for purchasing a quality Rosewill Product.

Please register your product at : www.rosewill.com/

for complete warranty information and future support for your product.

If you have any question while using our products, please feel free to contact us at feedback@rosewill.com