

Space Saving 120 Volt Portable Compact Electronic Top Load Washer

French

Spanish

Welcome to the world of
Haier Compact Portable Laundry!

- Efficient, Compact and Portable
- Easy Installation and Use
- Uses Convenient Standard 120VAC -15 amp Outlets
- You can install them anywhere!

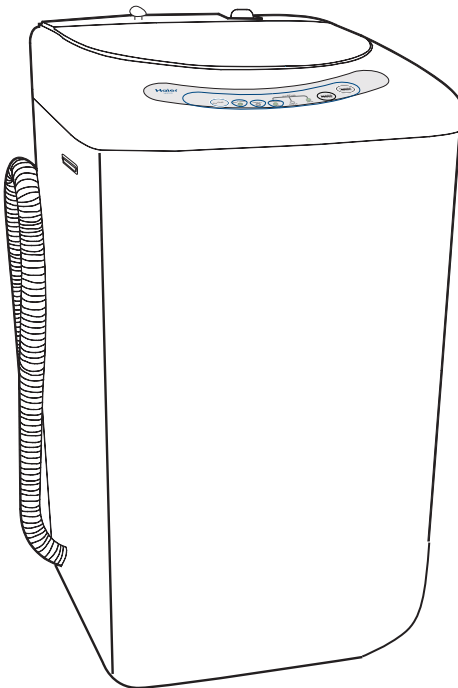

User Manual
HLP021-WM

Guide de l'Utilisateur
HLP021-WM

Manual del Usuario Modelo
HLP021-WM

Haier

Quality ▪ Innovation ▪ Style

UNPACKING YOUR WASHING MACHINE



1. Inspect and remove all packing materials. This includes the foam and any adhesive tape both inside and outside of the unit.
2. Inspect and remove any remains of packing, tape or printed materials before powering on the Washer.

DANGER

Risk of child entrapment. Before throwing away your old appliance, remove the door so that children may not easily become trapped inside.

PRODUCT REGISTRATION

Thank you for purchasing our Haier product. This easy-to-use manual will guide you in getting the best use of your washer.

Remember to record the model and serial number. They are on a label in back of the washer.

Model number

Serial number

Date of purchase

Staple your receipt to your manual.

You will need it to obtain warranty service.

Please register your product online at www.prodregister.com/haier



IMPORTANT SAFETY INSTRUCTIONS

Warning – To reduce the risk of fire, electric shock, or injury to persons when using your appliance, follow basic precautions, including the following:

1. **Read all instructions before using the appliance.**
2. Use this appliance only for its intended purpose as described in this use and care guide.
3. Use only detergents or softeners as recommended for use in this manual and keep them out of the reach of children.
4. This appliance must be properly installed in accordance with the installation instructions before it is used.
5. Never unplug your appliance by pulling on the power cord. Always grasp the plug firmly and pull straight out from the outlet.
6. Replace immediately any worn power cords, loose plugs and power outlets.
7. Unplug your appliance before cleaning or before making any repairs.
8. If your old appliance is not being used, we recommend that you remove the door. This will reduce the possibility of danger to children.
9. Do not operate your appliance in the presence of explosive fumes.
10. Do not use this appliance to wash clothes that have been soaked, spotted or washed in gasoline, dry cleaning solvents or any other explosive or flammable substances that may ignite and explode.
11. Clothes or rags used to clean flammable or explosive materials should not be washed in this appliance until all traces of this material have been removed.
12. Do not add or mix any flammable or explosive substances to the wash.
13. Do not try to remove clothes while the tub is moving. Allow it to come to a complete stop before reaching in.
14. The appliance's loading door must be closed when the tub is spinning.
15. Do not operate your appliance when parts are missing or broken.
16. Do not use this appliance for commercial uses.
17. Do not operate this appliance unless all enclosure panels are properly in place.
18. Do not tamper with controls.
19. To reduce the risk of injury, do not allow children to play in or on the appliance. Close supervision of children is necessary when the appliance is used near children.

20. This appliance must be connected to a proper electrical outlet with the correct electrical supply.
21. Proper grounding must be ensured to reduce the risk of shock and fire. **DO NOT CUT OR REMOVE THE GROUNDING PLUG.** If you do not have a three-prong electric receptacle outlet in the wall, have a certified electrician install the proper receptacle. The wall receptacle **MUST** be properly grounded.
22. Hydrogen gas may be produced if the water heater has not been used in more than 2 weeks. This may be explosive under certain circumstances. If this is the case turn on all the hot faucets and let the hot water run for a few minutes before using this appliance. This will let the trapped hydrogen escape. Avoid accidents during this process by refraining from turning **ON** any electrical appliances, smoking, lighting a match/lighter, and using flames.
23. Do not repair or replace any part of the appliance or attempt any servicing unless specifically recommended in the user-repair instructions, which you understand and have the skill to carry out.
Note: If for any reason this product requires service, we strongly recommend that a certified technician perform the service.
24. To reduce the risk of electric shock or fire, do not use extension cords or adapters to connect the unit to an electrical power source.

SAVE THESE INSTRUCTIONS HOUSEHOLD USE ONLY

Tools and Materials Required

You will need to use the following tools when installing your washer:



①



②

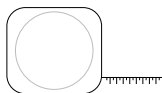

③



④



⑤

1. Phillips Screwdriver - For bottom plate.
2. Open End Pliers - To secure intake hose.
3. Tape Measure - Check measurement of washer location.
4. Level - To balance washer.
5. Wrench - To attach and lock caster.

SAFETY INSTRUCTIONS

Electrical Requirements



WARNINGS:

Grounding Instructions

This appliance must be grounded. It is equipped with a 3-wire cord having a grounded plug. The plug must be plugged into an outlet which is properly installed and grounded.

Warning! Improper use of the grounded wire can result in the risk of electric shock. Consult a qualified electrician if necessary. Do not attempt to defeat this safety feature by modifying the plug.

Avoid the use of an extension cord because it may overheat and cause a risk of fire. However, if it is necessary to use an extension cord:

- Use only 3-wire extension cord with 3-blade grounding plug.
- The marked rating of the extension cord must be equal to or greater than the rating of this appliance.
- It should be positioned such that it does not drape over the counter or tabletop where it can be pulled on children or tripped over.

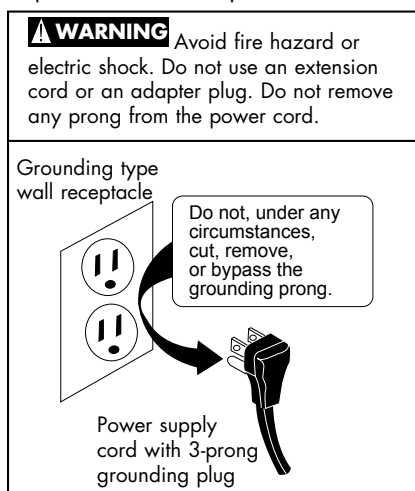

Attempting any maintenance or cleaning:

To minimize the possibility of electric shock, unplug this appliance from the power supply or disconnect the dryer at the household distribution panel by removing the fuse or switching off the circuit breaker before attempting any maintenance or cleaning (except the removal and cleaning of the lint filter).

Note: Pressing the Power ON/OFF button to an off position or pressing Start / PAUSE button, does NOT disconnect the appliance from the power supply.

Wiring Requirements

- This appliance must be plugged into at least a 15 AMP 110-115 VOLT, 60 HZ GROUNDED OUTLET.

TABLE OF CONTENTS

	PAGE
SAFETY INSTRUCTIONS	1-2
PARTS AND FEATURES	4-5
OPERATING YOUR WASHER	6-11
UNPACKING AND ACCESSORIES INVENTORY	12
PROPER LOCATION	13
INSTALLATION INSTRUCTIONS	14-16
UNIT DIMENSIONS	17
ELECTRICAL CONNECTIONS	18
PROPER CARE AND CLEANING	19
TROUBLESHOOTING GUIDE	20-21
WARRANTY	22

UNPACKING AND CHECKING PARTS



Unpacking

1. Remove all packing materials. This includes the foam base and all adhesive tape holding the washer accessories inside and outside. Slide out and remove the bottom Styrofoam that is used to protect the washer from shipping damage due to vibrations and shock.
2. Inspect and remove any remaining packing, tape or printed materials before using the washer.

Note: The bottom panel is located between the top foam used for protection and box.

Parts

- | | |
|----------------------------------|--------------------------------|
| a) 1 Bottom Panel | f) 1 Quick Sink Faucet Adapter |
| b) 6 Screws for the Bottom Plate | g) 2 Washers |
| c) 1 Water Inlet Hose | h) 1 Lint Filter |
| d) 1 Drain Hook (Gooseneck) | i) 4 Caster |
| e) 1 Wrench | |

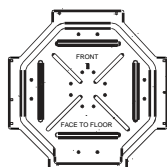

a



b



c

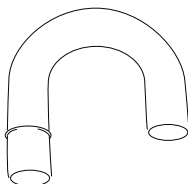

d



e

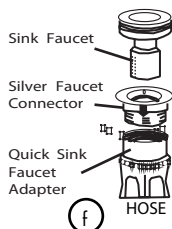

f



g

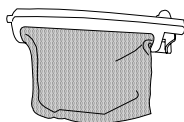

h

Optional 4 Pack

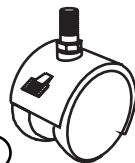

i



Check to make sure that the accessories are present and in good condition. If you find that they are not in good condition or are missing, please contact our customer service department for assistance. **Our Toll-Free number is 1-877-337-3639.**

WASHER PARTS AND FEATURES

Front View

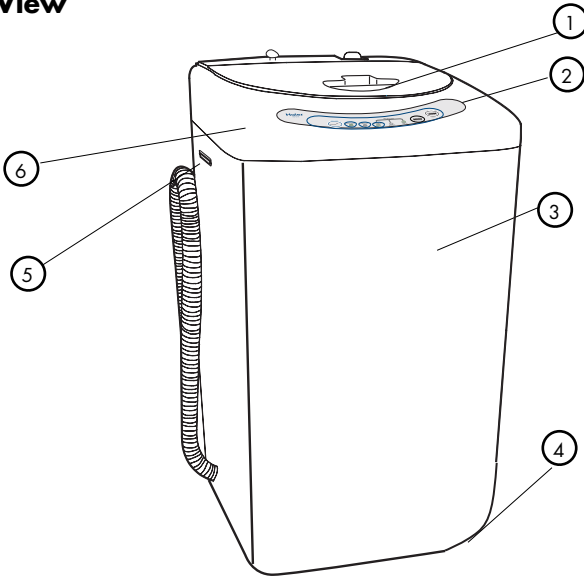

- 1. Top Lid
- 2. Control Panel
- 3. Washer Cabinet
- 4. Front Leveling Leg (or for Caster)
- 5. Cabinet Handle (located on both sides of the washer)
- 6. Control panel

Back View

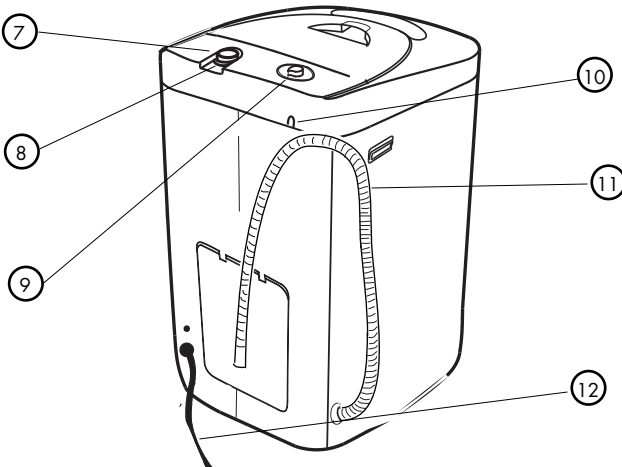

- 7. Water Inlet Fitting
- 8. Water Absorption Cushion
- 9. Water Level Selector
- 10. Power Cord Holder Clip
- 11. Drain Hose
- 12. Power Cord (120 Volt / 60 Hz)

CONTROL PANEL

1. Cycle Button

Choose washing cycle

Normal - Normal Wash

Heavy - Huge and heavy garments

Quick Wash - Small loads that are slightly soiled

2. Status Indicator Lights

Indicates cycle chosen with stages of cycle in operation.

3. Start/Pause Button

With Power "ON" Press the "Start/Pause" button to start washing cycle, pause operation, or resume operation.

4. Power ON/OFF Button

Press in the "Power On/Off" button to turn on the power of the washer.

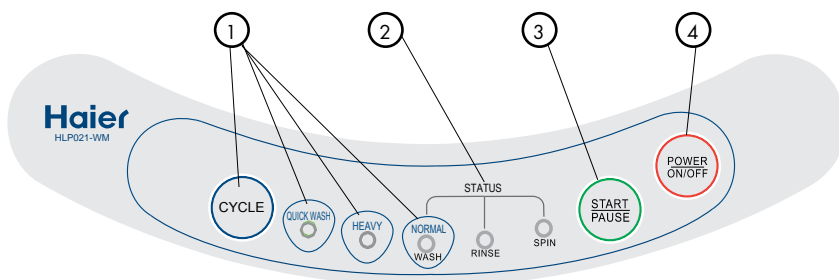

Water Level Selector Knob

Select water height in drum based on laundry being washed.

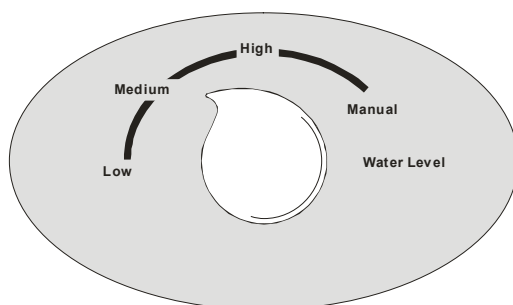

QUICK SET-UP INSTRUCTIONS FOR NORMAL WASH

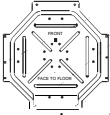
1. Locate the best place for using your NEW compact portable washer. Make sure it is near a 120 volt outlet and a water source, like a sink, with a drain. 
2. Screw on the bottom plate with the six (6) screws provided. 
3. Connect the water inlet hose, Using the Quick connect fitting, or directly connect to faucet.
4. Place drain hose in drain or inside the sink using the Drain Hook.

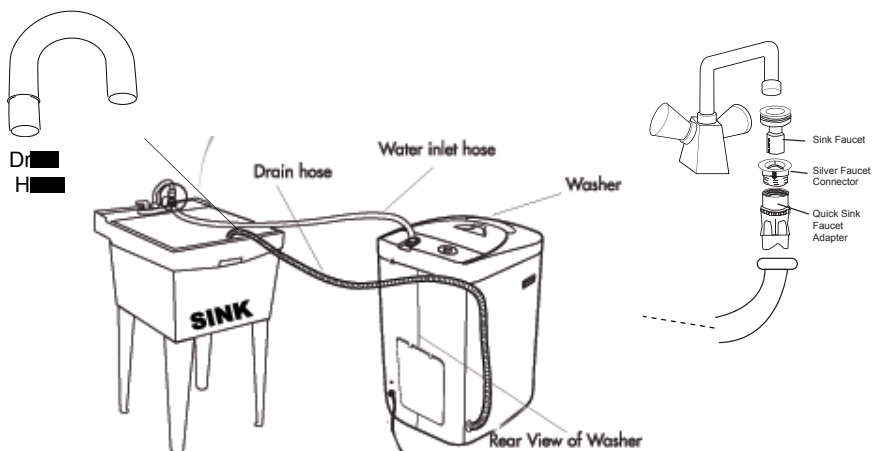

5. Make sure the lint filter is in place, it is installed on the side of the drum.
6. Ensure nothing but clothing is in the washer, then plug power cord into a 15 AMP 110-120 VOLT, 60 HZ GROUNDED OUTLET ONLY.
7. Proceed by pressing the "POWER ON" button. 
8. Select water height
9. Select "NORMAL" washing using the "CYCLE" button, then press the "START" button.

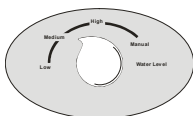

PROPER LOCATION

- Select a suitable location for the washer on a hard even surface away from direct sunlight and heat sources (e.g., radiators, baseboard heaters, cooking appliances, etc.).
- Verify the compact washer's measurement with the location you have selected and make sure the washer will fit.
- Make sure you have a grounded 120 volt outlet next to the area of washers use.
- Any floor unevenness should be corrected with the leveling leg located on the bottom right corner of the washer.

Cold Environments

- The washer must be placed and used at room temperatures ONLY. You must not place the washer where the temperature is at or below freezing or outside.
- This appliance must be stored at room temperature. Do not install or operate this appliance in an area where room temperature is below freezing.
- If you received this appliance when the outside temperature is below freezing, do not operate until this appliance has warmed to room temperature.

Unit Dimensions

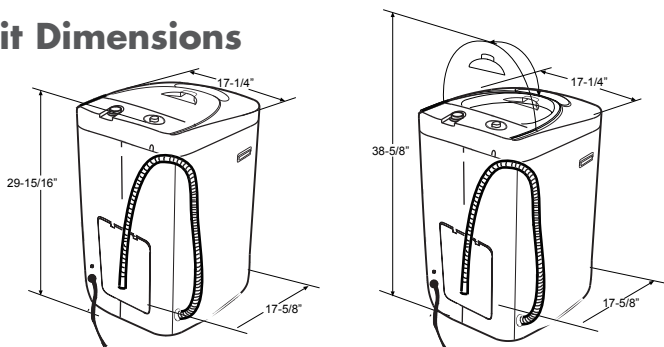

INSTALLATION INSTRUCTIONS

Read carefully and understand all installation instructions before installing this washing machine. If after completing the process you are still unsure whether the washer has been properly installed, we recommend that you contact a qualified installer.

Step 1

Installing the Bottom Panel

The bottom panel blocks noises to provide you with the quietest performance possible during the wash cycle operation.

1. First, lay down the washer on its front side.
2. Place the panel against the bottom of the machine. Align the holes in the panel with the holes in the washer.
3. Insert the screws through the holes of the panel into the bottom of the washer and tighten. (6 screws are supplied)
4. Once all screws have been installed and the panel is in place, return the washer to its standing position.

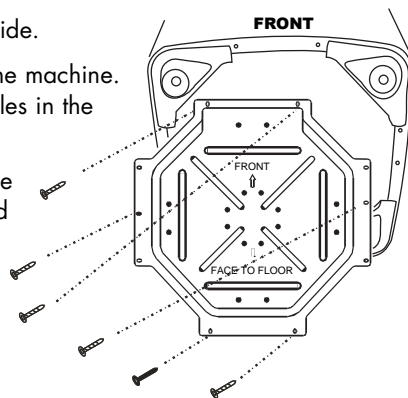

Note: During this time, you may reroute the drain hose to the left or right side for draining. Just remove hose clamp and snake to other side, then reinsert hose to other side

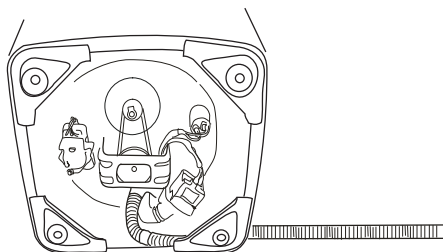
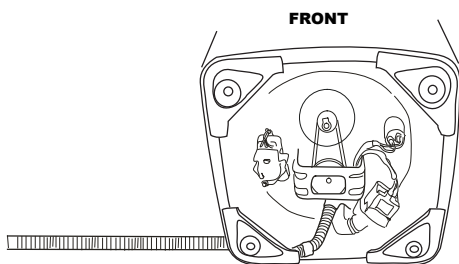

Leveling the Washer

Your washer has an adjustable leveling leg that is located on the front right corner. After properly placing your washer in its final location, you must level the washer.

Warning! An "off-balance" washer will not function properly and can stop. Using a level is best practice.

- Loosen the adjustable outer and larger ring of the fixed foot. The leveling leg can be adjusted by turning the center foot counter-clockwise to raise the foot and clockwise to lower the washer. Once the foot is at the right height, then lock that position using the outer and larger ring of the fixed foot. This should be done for all feet of the washer.

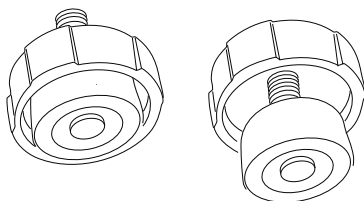

Note: If the washer is inclined more than 2°, the machine will not operate.

Caster Option

This washer can convert from fixed feet to casters for mobility and portability. The best time to change from fixed feet to casters is when installing the bottom panel.

Unscrew and remove the fixed feet.

Screw each of the 4 casters to the bottom base by hand first, then use a wrench to secure the caster's locking bolt to the washer body.

Locking caster;
Lift tab DOWN to lock and UP to unlock

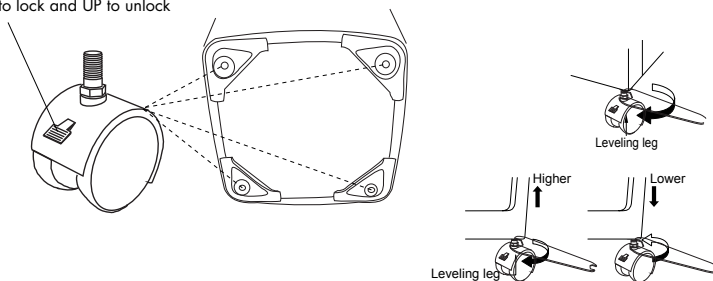

Installing Your Washer

Read the installation instructions carefully and ensure washer location before beginning.

Installing Quick Sink Adapter:

When installing the quick sink faucet adapter to the faucet, follow the steps below:

1. First, remove the aerator from your faucet nozzle and determine the size/type of the faucet.
2. Once you determine the size/type of the faucet (Outside Threaded End or Inside Threaded End), place the proper sized rubber washer into the silver faucet adapter.



A
Outside Thread



B
Large Inside thread
3. Attach the silver faucet connector to the faucet.
4. Attach the faucet connector to the water inlet hose and make sure that the rubber washer is placed in between.
5. Attach the other end of the water inlet hose to the washer water inlet and make sure that the rubber washer is placed in between.

Attached hose to water inlet

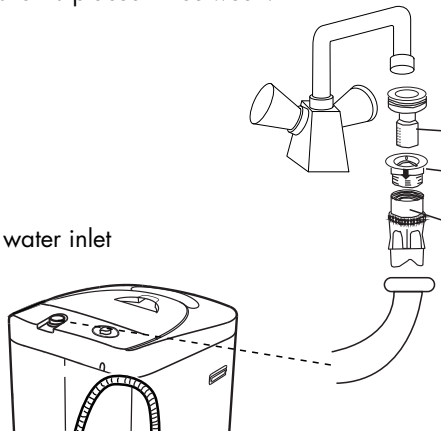

As a second option, you can install directly to a fixed utility hot and cold water outlet by using a "Y Hose" (NOT supplied) .

To washer inlet

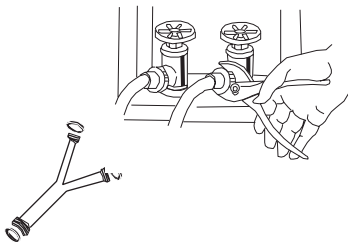

Note: Incoming hot water must not exceed 122°F/50°C.

6. The drain hose must be placed into a drainpipe or sink at least 1-1/2 inches in diameter. Use the gooseneck drain hook to hold the hose in place. To avoid possible water back-up, the drain hose must reach a height of at least 31-1/2 inches minimum and 40 inches maximum.

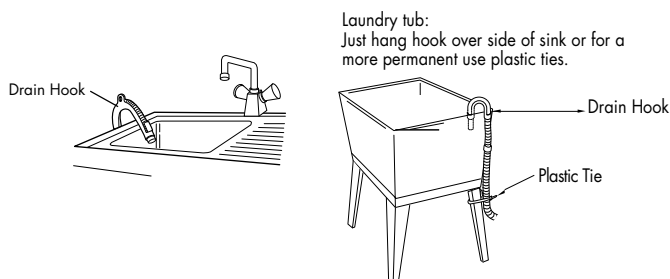

Final connection of washer to sink should look like this.

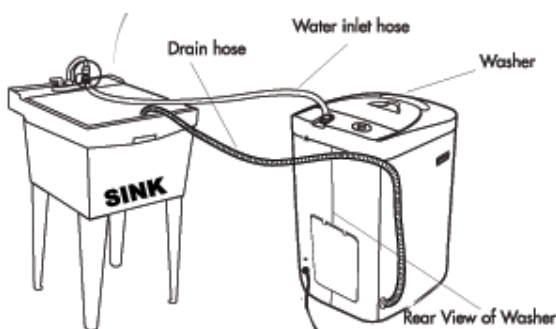

7. Make sure the lint filter is installed. The lint filter must be installed before the washer is used. The lint filter is packaged with the User Manual.
8. Plug in the washer to a regular 115 Volt / 60 Hz, 15 Amps outlet, only after all water and drain lines are connected .

Note: Carefully inspect for any leaks around the machine and at the back. If there is a leak, check if any connections are loose. You may need to tighten any loose connections. Do not remove the water absorption cushion. Check before each use to make sure it is not damaged.

CAUTION! If after completing these steps you are still unsure whether unit has been properly installed, contact a qualified installer. We recommend that the washer be installed by a certified technician to ensure that it is properly installed.



Installing the Lint Filter

The lint filter must be installed before the washer is used. The lint filter is packaged with the User Manual.

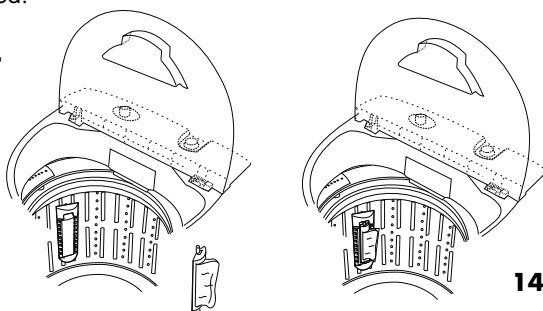

OPERATING YOUR WASHER

The Control Panel

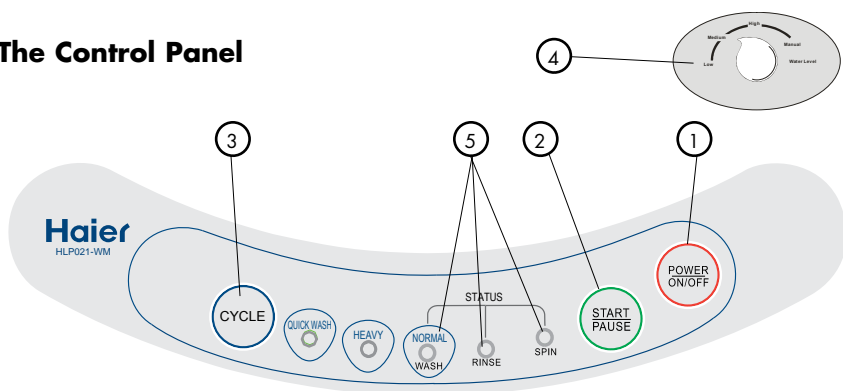

Power ON/OFF: (1)

- Press the POWER button once to turn ON the power to the washer. Press it again to turn the power OFF.



Start/Pause: (2)

- Press this button once to start the wash process. Press this button once again to pause the activity during the wash cycle. Push it again to resume the wash cycle.



CYCLE Select: (3)

- Select your desired cycle program by pressing the "CYCLE Select" button. There are 3 main washing cycles, Normal, Heavy and Quickwash, along with a total of 7 wash operation options. Press the CYCLE select button for the desired setting.

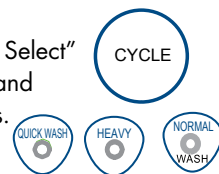

Water Level Selector: (4)

- Turn the Water Level Selector knob to select the proper water level setting. You may select from low, medium and high water level settings depending on the wash load. There is also a MANUAL override, by holding the knob in the manual position, until the desired water level is achieved

Function and Status Indicator Lights: (5)

- The function display lights indicate that a selected feature is ON or what the cycle is about to begin.

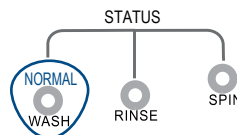

- During the wash cycle, a flashing light indicates the current STATUS of wash/rinse/spin cycle.

Note: Rapid flashing indicates that the washer is not operating properly.

Steps for the Wash Process

1. The lint filter must be cleaned and in place before you start washing
2. Turn the power ON by pressing the "ON" button.
3. Press "Cycle Select" to select the wash program.
4. Select the water level.
5. Add the detergent.
6. Add the wash load.
7. Press the Start / Pause button.
8. After the washing machine starts, you may change the Cycle or program by turning OFF the machine and then restarting to make the new selection.

Note: If the washer is turned ON without any water in the tub, it will start to spin after a few minutes. The pulsator will not rotate unless the water is filled to a selected level.

Note: Do not use the "HEAVY Wash" program for woolen clothing.

Note: Loading the Washer

- Load each item loosely.
- Separate the white from the colored clothing. Separate heavy fabrics from light fabrics.
- Carefully check all pockets and cuffs for foreign items. They can easily slide into the tub and cause damage to the tub and/or make disturbing noises during cycles.
- Always balance the laundry load evenly within the washer tub, so there is no single heavy areas and all the laundry is evenly distributed.

Lint Filter and Water Filter

- The Lint filter is located inside the washer drum. A small nylon bag collects lint and residue from clothes during the wash cycle.

Note: NEVER wash your clothes without the filter in its compartment inside the tub.

- You must clean the filter after every load for the best results. Push down the tab in the filter to remove. Clean and slide the filter back in place.
- There is also a filter in the water inlet valve. This prevents foreign particles in the water from entering the washer. Clean this at least once a month.

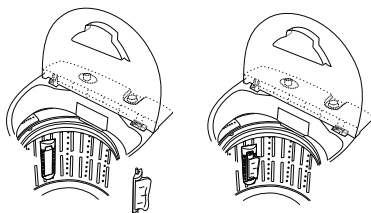

Selecting the Wash Cycle

When you first turn on the POWER, the washer will automatically be set for the **NORMAL wash cycle**, for Wash, Rinse & Spin. The LED indicators will be lit, to show cycle program.

Power ON

Wash, Rinse & Spin

Normal Wash

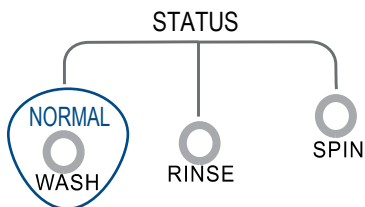

Then press the START button to begin.



- With POWER ON, Press the "CYCLE Select" button for your desired wash cycle. Choose between 7 various washing cycles options. Each time you press the CYCLE button, you will move through the washers cycle menu. When you finalize your selection, please press the START button.



Program Select	Wash Program	Application
1. Power ON	Normal Wash Cycle	Wash, Rinse & Spin
2. Press Once	Wash only	No Spin or Rinse
3. Press Twice	Wash & Rinse only	No Spin
4. Press Three Times	Rinse & Spin only	No Wash
5. Press Four Times	Spin only	No Wash or Rinse
6. Press Five Times	Heavy Wash Cycle	Heavy Wash, Wash, Rinse, Spin
7. Press Six Times	Quick Wash Cycle	Quick, Wash, Rinse, Spin

Approximate Wash Times

Wash Program Times	Soak (approx minutes)	Wash (approx minutes)	Rinse Minutes / Times	Spin (approx minutes)	Total (approx minutes)
NORMAL Wash Wash, Rinse & Spin	None	8 – 15	6 / 2	4	35 – 42
Heavy Wash Twice Wash, Wash, Rinse & Spin	25	16 – 30	6 / 2	4	68 – 82
Quick Wash Quick, Wash, Rinse & Spin	None	5 - 9	3 / 1	4	21 – 28

Note:

- The total wash times will vary depending on cycle.
- The total time includes the normal water inlet time and drain time. The total washing time may be affected by the water inlet pressure and water level.
- The spin time is the time from the intermittent running to the finishing of the cycle.
- In the "Heavy Wash" program, (heavy soiled laundry) the first soak is approximately 20 minutes, pre-wash is approximately 8 minutes. Clothes are soaked again for approximately 5 minutes. The washing, rinsing and spinning will then be completed. The wash time includes the pre-wash time.
- In the "Quick" program select wash, (fast wash, for delicates) rinse and spin are set automatically. No procedure can be selected after setting.

Note: When you turn the power OFF, then ON; the machine will reset to the standard NORMAL wash program with wash/rinse/spin applications.

Selecting the Water Level

- There are 3 pre-set water levels to choose from: Low, Medium and High and 1 manual override selection using the knob. Your selection may depend on your wash load.

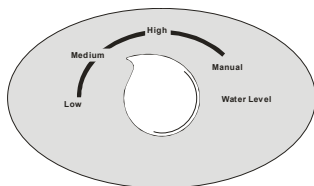

- Turning the knob to “MANUAL” will add more water to your wash load as long as it is held in that position. Release knob after setting to the desired water level by manually adding water.

Recommended Water Levels

Load Size in lbs	Water Level	Approximate Water used in Gallons
3.3	High	8.72
1.76	Medium	5.81
Less than 1.76	Low	3.70

End-of-Cycle Signal

The machine will beep at the end of the cycle, indicating that the washing is complete. The “Wash/Rinse/Spin” indicator lights will still be ON. The washer will turn OFF automatically in approximately 10 minutes after the completion of the cycle.

Closing the Top Lid

For safety purposes, the top lid must always be closed during the wash process. If you open the top lid while the wash cycle is in progress, you will observe the following:

- An alarm will sound.
- The tub will not spin while the lid is open.
- If the unit is in wash mode, it will stop running.

Simply close the top lid and press the start/pause button to resume the cycle.

Loading the Washer

- Load each item loosely.
- Separate the white from the colored clothing. Separate heavy fabrics from light fabrics.
- Carefully check all pockets and cuffs for foreign items. They can easily slide into the tub and cause damage to the tub and/or make disturbing noises during cycles.
- Pre-treat all stains and heavily soiled areas for best results.
- Do not overload your washer.
- Close the door or top lid properly after loading the clothes.
- When loading wet items, keep water level high enough to keep the unit in balance and to allow clothing to float easily in the water.

Proper Use of Detergent

- Fill water in the tub at the "Low" water level.
- Add the detergent.
- Load the washer.
- Select the water level.

Note: The amount of detergent used depends on the size of the load, the water type (hard or soft) and whether the clothes are heavily soiled or lightly soiled. Besides the performance of the washing machine, the quality of the detergent also affects the wash result. For best results, use low sudsing detergents only. Refer to the detergent manufacturer's recommended amount for usage.

Proper Use of Bleach

Refer to the bleach manufacturer's chart for the recommended use of liquid bleach. Dilute the bleach and add it to the water before putting clothes into the washtub.

Warning! Be careful not to spill undiluted bleach onto the washer cabinet or onto clothing. It is a strong chemical that may damage your clothes and the finish of the washer if not properly diluted.

PROPER CARE AND CLEANING

Warning! Always unplug your appliance before cleaning to avoid electric shock. Ignoring this warning may result in personal injury or death. Before using cleaning products, always read and follow the cleaning product manufacturer's instructions and warnings to avoid personal injury and product damage.



General Cleaning and Maintenance

Use only a damp or sudsy cloth to clean the control panel.

- To avoid any kind of damage to the cabinet finish, wipe the appliance cabinet as needed. If liquid/powdered softener, bleach or detergent is spilled onto the cabinet, wipe the cabinet immediately because it may cause damage to the finish.
- Do not use any abrasives, harsh chemicals, ammonia, chlorine bleach, concentrated detergent, solvents or metal scouring pads. Some of these chemicals and materials may dissolve, damage and/or discolor your appliance.
- Remove pins and other sharp objects from clothing to prevent scratches on interior parts.
- The lint filter must be cleaned before each use for optimal efficiency. **DO NOT USE YOUR WASHER WITHOUT THE LINT FILTER IN PLACE.**
- The filter screen of the water inlet valve may become blocked by soil and residue. Please clean it with a brush monthly.

Long Absences / Moving

- Turn OFF the water supply faucets and disconnect the hoses. Drain water from all hoses. This will prevent damage from water leakage if the hoses are accidentally ruptured or if they become loose.
- Disconnect the electrical plug.
- Dry the inner washtub. If moving the washer, disconnect the drain hose.
- To prevent mold and mildew, leave the door open so that the moisture inside the machine can evaporate.
- Reinstall the foam base/Styrofoam at the bottom of the unit to prevent internal parts from becoming damaged due to vibrations and shock when the washer is being moved to another location.

Normal Operating Sounds

The following sounds are normally heard during the operation of the washer:

- Tumbling sounds can be heard as heavy wet clothes in the washer are tossed around continuously.
- Air rushing noise is the result of the washtub spinning at a very high RPM.
- Clicking sounds are caused by the wash and rinse cycles turning ON and OFF.

TROUBLESHOOTING GUIDE

Before calling for service, determine the symptoms and follow the suggested solutions:

Washer does not operate:

- Check if the unit is plugged in. The plug may have come loose.
- Check if the electrical wall receptacle is of proper voltage.
- Check if the circuit breaker needs to be reset or if the fuse needs to be replaced.
- Check if the washer is overloaded. Reload and redistribute the clothing to rebalance the machine.
- Check if the door is open. You may have to close the door properly.
- Check if the program selections are set properly. You may have to adjust the settings.
- Check the Power "ON/OFF" button to see if it is in the OFF position. You may need to press the button to set it in the ON position.
- Check if the "Start/Pause" button is on "Pause" mode. Press this button to start the wash process.
- The wash process is paused. This is normal. The clothing sensor is checking to verify that there are clothes inside the washtub. Water will be added approximately 48 seconds later.
- The pulsator pauses during incoming water flow in the wash and rinse cycle. This is normal. This prevents splashing during water inlet.
- The washer may need to be reloaded and the clothes may need to be rebalanced.

Problems with water:

- Not enough water is coming in - The water faucet may need to be fully turned ON. Water hose may be tangled or bent; straighten the hose. Check the water level selection. It may need to be readjusted. This may cause the wash program to pause for a few minutes after water inlet.
- Water leaks - This is due to improper installation of the drain hose or fill hose. Your home drain may be clogged. You may need to tighten the hose, check the plumbing or call a plumber. Water may also leak if the machine is overloaded or if too much detergent is used.
- Water does not drain - This is due to improper installation of the drain hose. You may need to connect the drain hose properly. Check the position of the drain hose. The drain hose may be clogged or bent.
- Water flows out of the drain hose during the first use of the machine - This may be the water left in the tub after the factory inspected the unit to test its performance in order to ensure the best quality.

Washer makes noises:

- Washer may need to be reinstalled and leveled. Refer to the washer installation section.
- Wash load may need to be rebalanced, as the load may be uneven.
- Coins, loose change, buttons or other heavy objects may be making the noise.
- A squeaking sound may be due to an overloaded wash tub.
- Vibration noises are due to an improper leveling of the washer or an uneven distribution of clothing in the tub.

Problems with clothing:

- Clothes are too wrinkled – Clothes have been improperly sorted or the machine has been overloaded. Do not mix heavy clothes such as work clothes with light clothes such as blouses, light shirts and delicate items.
- Clothes have soap residue – The detergent may not be dissolving in the water. Check the water temperature or add detergent as the washtub is being filled with water (before you load your clothes) to avoid soap residue on clothes. Liquid detergent is recommended.
- Clothes are ripped or have holes - Sharp objects such as pins and belt buckles were left in the washtub. You must remove small, loose, sharp objects. Fasten belts, zippers, metal snaps etc. Check if you are using undiluted bleach. Never add undiluted bleach to the wash.

Other:

- The spinning is intermittent when it starts – The laundry needs to be balanced to avoid slanting. Move the laundry around to equalize the load.
- The “Spin” does not work in Program Select – The program is setting the drain time. Spinning will start in a few minutes.
- During the final spinning, it stops, the “Rinse” indicator lights up and the washer starts to fill with water – The wash load is slanting on one side. After the water is filled, the slanting will be removed and the spinning will be reactivated.

Welcome to the world of
Haier Compact Portable Laundry!

- Efficient, Compact and Portable
 - Easy Installation and Use
- Uses Convenient Standard 120VAC -15 amp Outlets
 - You can install them anywhere!

LIMITED WARRANTY

In Home Service

Full ONE Year Warranty

For 12 months from the date of original retail purchase, Haier will repair or replace any part free of charge including labor that fails due to a defect in materials or workmanship.

Limited Warranty

After one year from the original retail purchase date, Haier will provide a part at no cost, as indicated below, to replace said part as a result of a defect in materials or workmanship. Haier is solely responsible for the cost of the part. All other costs such as labor, trip charge, etc are the responsibility of the owner.

Second through Fifth Year

Haier will provide the outer washtub and related outer tub assembly parts should the part fail to hold water.

Second through Seventh Year

Haier will provide the inner stainless steel wash tub if defective in material or workmanship.

Note: This warranty commences on the date the item was purchased and the original purchase receipt must be presented to the authorized service representative before warranty repairs are rendered.

Exceptions: Commercial or Rental Use Warranty

90 days labor from date of original purchase

90 days parts from date of original purchase

No other warranty applies

For Warranty Service

Contact your nearest authorized service center. All service must be performed by a Haier authorized service center. For the name and telephone number of the nearest authorized service center please call 1-877-337-3639.

Before calling please have available the following information:

Model number and serial number of your appliance. The name and address of the dealer you purchased the unit from and the date of purchase.

A clear description of the problem.

A proof of purchase (sales receipt).

This warranty covers appliances within the continental United States, Puerto Rico and Canada. What is not covered by this warranty:

Replacement or repair of household fuses, circuit breakers, wiring or plumbing.

A product whose original serial number has been removed or altered.

Any service charges not specifically identified as normal such as normal service area or hours.

Damage to clothing.

Damage incurred in shipping.

Damage caused by improper installation or maintenance.

Damage from misuse, abuse accident, fire, flood, or acts of nature.

Damage from service other than an authorized Haier dealer or service center.

Damage from incorrect electrical current, voltage or supply.

Damage resulting from any product modification, alteration or adjustment not authorized by Haier.

Adjustment of consumer operated controls as identified in the owner's manual.

Hoses, knobs, lint trays and all attachments, accessories and disposable parts.

Labor, service transportation, and shipping charges for the removal and replacement of defective parts beyond the initial 12-month period.

Damage from other than normal household use.

Any transportation and shipping charges.

THIS LIMITED WARRANTY IS GIVEN IN LIEU OF ALL OTHER WARRANTIES, EXPRESSED OR, INCLUDING THE WARRANTIES OF MERCHANTABILITY AND FITNESS FOR A PARTICULAR PURPOSE

The remedy provided in this warranty is exclusive and is granted in lieu of all other remedies.

This warranty does not cover incidental or consequential damages, so the above limitations may not apply to you. Some states do not allow limitations on how long an implied warranty lasts, so the above limitations may not apply to you.

This warranty gives you specific legal rights, and you may have other rights, which vary, from state to state.

Haier America
New York, NY 10018



IMPORTANT

Do Not Return This Product To The Store

If you have a problem with this product, please contact the
"Haier Customer Satisfaction Center" at 1-877-337-3639.

DATED PROOF OF PURCHASE, MODEL # AND SERIAL # REQUIRED FOR
WARRANTY SERVICE

IMPORTANT

Ne pas renvoyer cet appareil au magasin.

Si vous avez un problème avec cet appareil, veuillez contacter
le service à la clientèle de Haier au 1-877-337-3639.

IL EST OBLIGATOIRE DE FOURNIR UNE PREUVE D'ACHAT DATÉE, LE NUMÉRO DU MODÈLE
ET SON NUMÉRO DE SÉRIE AFIN DE BÉNÉFICIER DE LA COUVERTURE DE LA GARANTIE.

IMPORTANTE

No Devuelva Este Producto al Establecimiento Compra.

Si tiene problemas con este producto, por favor póngase en contacto con el
"Centro Haier de Atención al Cliente" en el 1-877-337-3639.

PARA EL SERVICIO DE GARANTÍA SE REQUIERE PRUEBA DE COMPRA, FECHADA,
No. DE MODELO Y No. DE SERIE



120 V, 60 Hz

Made in China
Fabriqué en Chine
Hecho en China

Haier

Haier America
New York, NY 10018

Printed in China