

42MF 230A 42'' Plasma TV



Thank you for choosing Magnavox

Need help fast?

***Read your Quick Use Guide and/or
Owner's Manual first for quick tips
that make using your Magnavox product
more enjoyable.***

***If you have read your instructions
and still need assistance,
you may access our online help at***

www.usasupport.magnavox.com

or call

1-800-705-2000

***while with your product.
(and Model / Serial number)***

Model No. : _____

Serial No. : _____

CONTENT

IMPORTANT SAFETY INSTRUCTIONS.....	1
FCC Notice	2
Precautions and Reminders	3
Front Panel Control.....	5
Basic Installation	6
Remote Control Function	7
OSD Menu Descriptions	
Main Menu	8
Setup Menu.....	8
Video Menu	9
Audio Menu	9
Feature Menu	10
EPG	11
TV Channel Arrangement.....	11
Specifications.....	12
Troubleshooting	13
MAGNAVOX Limited Warranty	14

Return your Product registration Card today to get the very most from your purchase.

Registering your model with MAGNAVOX makes you eligible for all of the valuable benefits listed below, so don't miss out. Complete and return your Product registration Card at once to ensure:

*Proof of Purchase

Returning the enclosed card guarantees that your date of purchase will be on file, so no additional paperwork will be required from you to obtain warranty service.

*Product safety Notification

By registering your product, you'll receive notification - directly from the manufacturer - in the rare case of a product recall or safety defect.

*Additional Benefits of Product Ownership

Registering your product guarantees that you'll receive all of the privileges to which you're entitled, including special money - saving offers.

MAGNAVOX

Congratulations on your purchase, and welcome to the "family!"

Dear MAGNAVOX product owner:

Thank you for your confidence in MAGNAVOX. You've selected one of the best-built, best-backed products available today. We'll do everything in our power to keep you happy with your purchase for many years to come.

As a member of the MAGNAVOX "family", you're entitled to protection by one of the most comprehensive warranties and outstanding service networks in the industry. What's more, your purchase guarantees you'll receive all the information and special offers for which you qualify, plus easy access to accessories from our convenient home shopping network.

Most importantly, you can count on our uncompromising commitment to your total satisfaction.

All of this is our way of saying welcome and thanks for investing in a MAGNAVOX product.

P.S. To get the most from your MAGNAVOX purchase, be sure to complete and return your Product Registration Card at once.

Know these
safety symbols



This "bolt of lightning" indicates uninsulated material within your unit may cause an electrical shock. For the safety of everyone in your household, please do not remove product covering.

The "exclamation point" calls attention to features for which you should read the enclosed literature closely to prevent operating and maintenance problems.

WARNING: To reduce the risk of fire or electric shock, this apparatus should not be exposed to rain or moisture and objects filled with liquids, such as vases, should not be placed on this apparatus.

CAUTION: To prevent electric shock, match wide blade of plug to wide slot, fully insert.

ATTENTION: Pour éviter les chocs électriques, introduire la lame la plus large de la fiche dans la borne correspondante de la prise et pousser jusqu'au fond.

For Customer Use

Enter below the Serial No. which is located on the rear of the cabinet. Retain this information for future reference.

Model No. _____

Serial No. _____

IMPORTANT SAFETY INSTRUCTIONS

Read before operating equipment

1. Read and follow all instructions.
2. Do not operate this apparatus near water.
3. Do not install near any heat sources such as radiators, heat registers, stoves, or other apparatus (including amplifiers) that produce heat.
4. Do not block any of the ventilation openings.
5. Clean only with a dry cloth.
6. Do not defeat the safety purpose of the polarized or grounding-type plug. A polarized plug has two blades with one wider than the other. A grounding type plug has two blades and third grounding prong. The wide blade or third prong are provided for your safety. When the provided plug does not fit into your outlet, consult an electrician for replacement of the obsolete outlet..
7. Protect the power cord from being walked on or pinched particularly at plugs, convenience receptacles, and the point where they exit from the apparatus.
8. Only use attachments/accessories specified by the manufacturer.
9. Use only with a cart, stand, tripod, bracket, or table specified by the manufacturer, or sold with the apparatus. When a cart is used, use caution when moving the cart/apparatus combination to avoid injury from tip-over.
10. Unplug this apparatus during lightning storms or when unused for long periods of time.
11. Refer all servicing to qualified service personnel. Servicing is required when the apparatus has been damaged in any way, such as power-supply cord or plug is damaged, liquid has been spilled or objects have fallen into apparatus, the apparatus has been exposed to rain or moisture, does not operate normally, or has been dropped.
12. This product may contain lead and mercury. Disposal of these materials may be regulated due to environmental considerations. For disposal or recycling information, please contact your local authorities or the Electronic Industries Alliance: www.eiae.org
13. **Damage Requiring Service** -The appliance should be serviced by qualified service personnel when:
 - The power supply cord or the plug has been damaged; or
 - Objects have fallen, or liquid has been spilled into the appliance; or
 - The appliance has been exposed to rain; or
 - The appliance does not appear to operate normally or exhibits a marked change in performance; or
 - The appliance has been dropped, or the enclosure damaged.
14. **Tilt/Stability**- All televisions must comply with recommended international safety standards for tilt and stability properties of its cabinet design.
 - Do not compromise these design standards by applying excessive pull force to the front, or top, of the cabinet which could ultimately overturn the product.
 - Do not endanger yourself, or children, by placing electronic equipment/toys on the top of the cabinet. Such items could unsuspectingly fall from the top of the set and cause product damage and/or personal injury.
15. **Wall or Ceiling Mounting**- The appliance should be mounted to a wall or ceiling only as recommended by the manufacturer.
16. **Power Lines**- An outdoor antenna should be located away from power lines.
17. **Outdoor Antenna Grounding**- If an outside antenna is connected to the receiver, make sure the antenna system is grounded so as to provide protection against voltage surges and built up of static charges. Section 810 of the National Electric Code, ANSI/NFPA No.70-1984, provides information with respect to proper grounding of the mast and supporting structure, grounding of the lead-in wire to an antenna discharge unit, size of grounding connectors, location of antenna-discharge unit, connection to grounding electrodes, and requirements for the grounding electrode. See Figure below.
18. **Object and Liquid Entry**- Care should be taken so that objects do not fall and liquids are not spilled into the enclosure through openings.
19. **Battery Usage CAUTION** –To prevent battery leakage that may result in bodily injury, property damage, or damage to the unit:
 - Install all batteries correctly, with + and - aligned as marked on the unit.
 - Do not mix batteries (old and new or carbon and alkaline, etc.).
 - Remove batteries when the unit is not used for a long time.
20. Keep this manual for future reference



Note to the CATV system installer: This reminder is provided to call the CATV system installer's attention to Article 820-40 of the NEC that provides guidelines for proper grounding and, in particular, specifies that the cable ground shall be connected to the grounding system of the building, as close to the point of cable entry as practical.

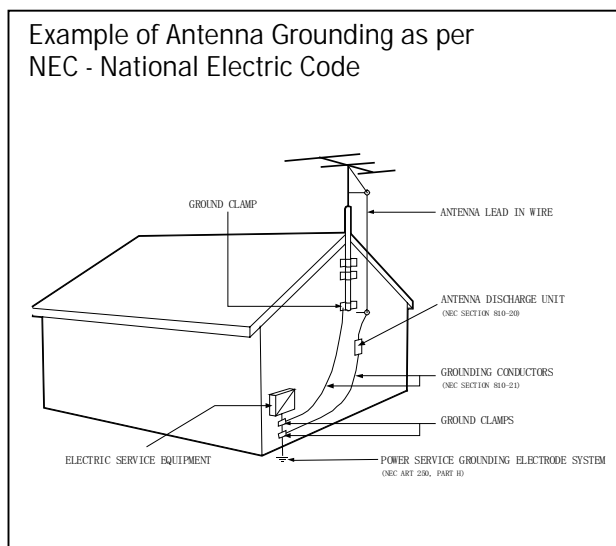

FCC Notice

This equipment has been tested and found to comply with the limits for a Class B digital device, pursuant to part 15 of the FCC Rules. These limits are designed to provide reasonable protection against harmful interference in a residential installation. This equipment generates, uses and can radiate radio frequency energy and, if not installed and used in accordance with the instructions, may cause harmful interference to radio communications. However, there is no guarantee that interference will not occur in a particular installation. If this equipment does cause harmful interference to radio or television reception, which can be determined by turning the equipment off and on, the user is encouraged to try to correct the interference by one or more of the following measures:

1. Reorient or relocate the receiving antenna.
2. Increase the separation between the equipment and receiver.
3. Connect the equipment into an outlet on a circuit different from that to which the receiver is connected.
4. Consult the dealer or an experienced radio/TV technician for help.

Modifications not expressly approved by the manufacturer could void the user's authority to operate the equipment under FCC rules. This device complies with part 15 of the FCC Rules.

Operation is subject to the following two conditions:

1. This device may not cause harmful interference.
2. This device must accept any interference received, including interference that may cause undesired operation.

Precautions and Reminders

X

Do not place unit on uneven surfaces.

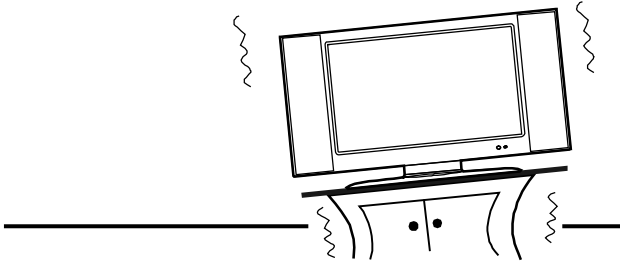

X

Do not place the TV in confined spaces or in a box when using it.

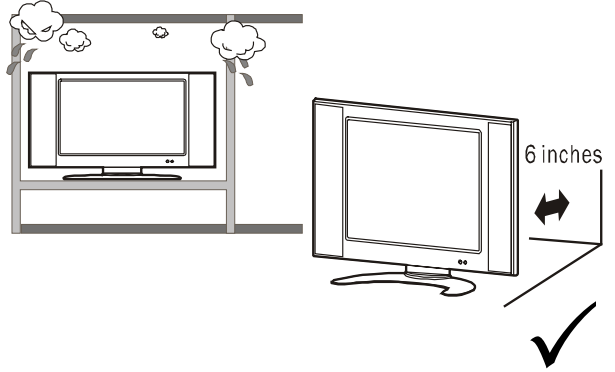

✓

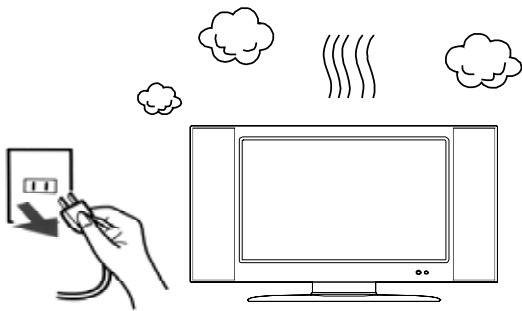

Unplug immediately if there is any malfunction, like no video, no audio, smoke or a bad odor.

✓

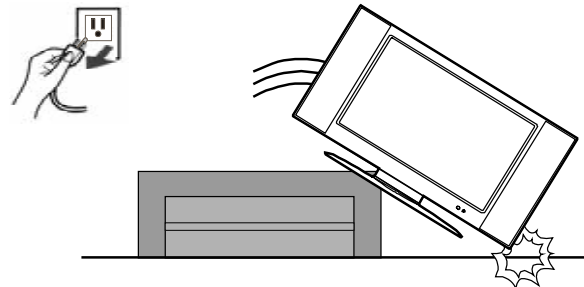

Unplug immediately if other foreign materials are put inside TV box or if the TV fell down.

X

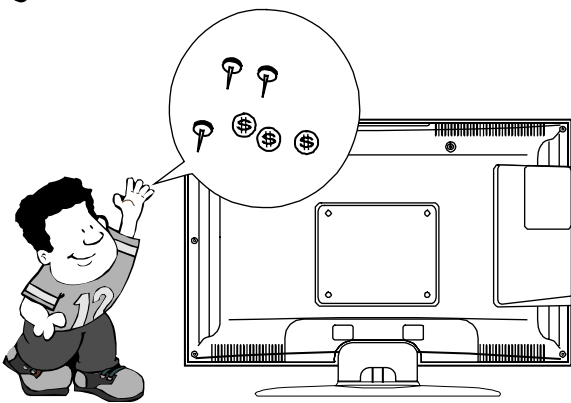

Do not throw any object like metals or flammable materials into the TV set.

X

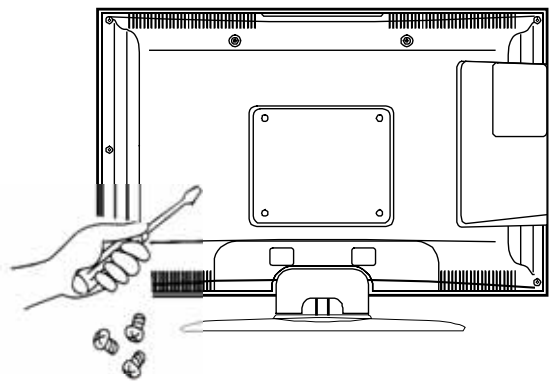

Prohibit/Avoid opening TV cabinet

Precautions and Reminders

✗

Do not use liquid cleaners or aerosol cleaners to clean the display. Remember to unplug the AC cord from the AC outlet before cleaning the display unit.

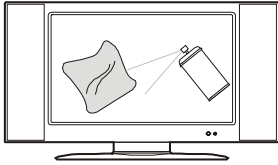

✗

Avoid direct sunlight, dusty, high humidity and smoky areas.

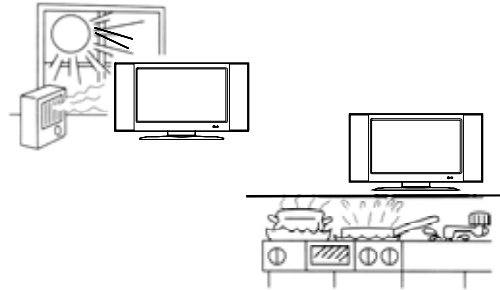

✓

Make sure to unplug the unit when not in use for a long period of time (2 days).

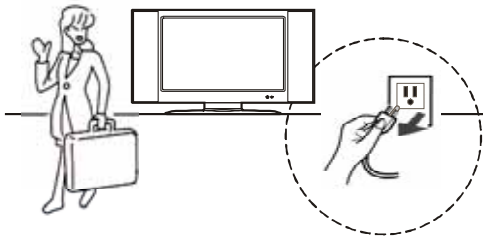

✓

Call service personnel to clean the internal part of the TV once a year.

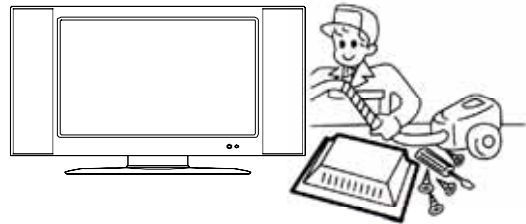

✗

Do not cover or block any vents and openings. Inadequate ventilation may shorten the life of the display unit and cause overheating.

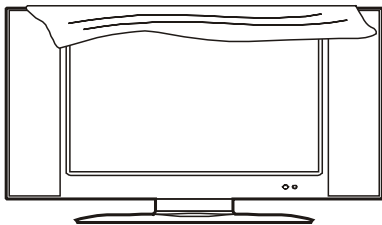

✗

Do not place the unit near water, such as bathtub, washbasin, kitchen sink laundry tub, swimming pool or in a damp basement.

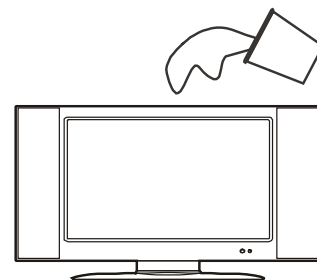

Notice for Remote Control

Avoid Dropping



Avoid Liquids





Avoid Aerosol Cleaners

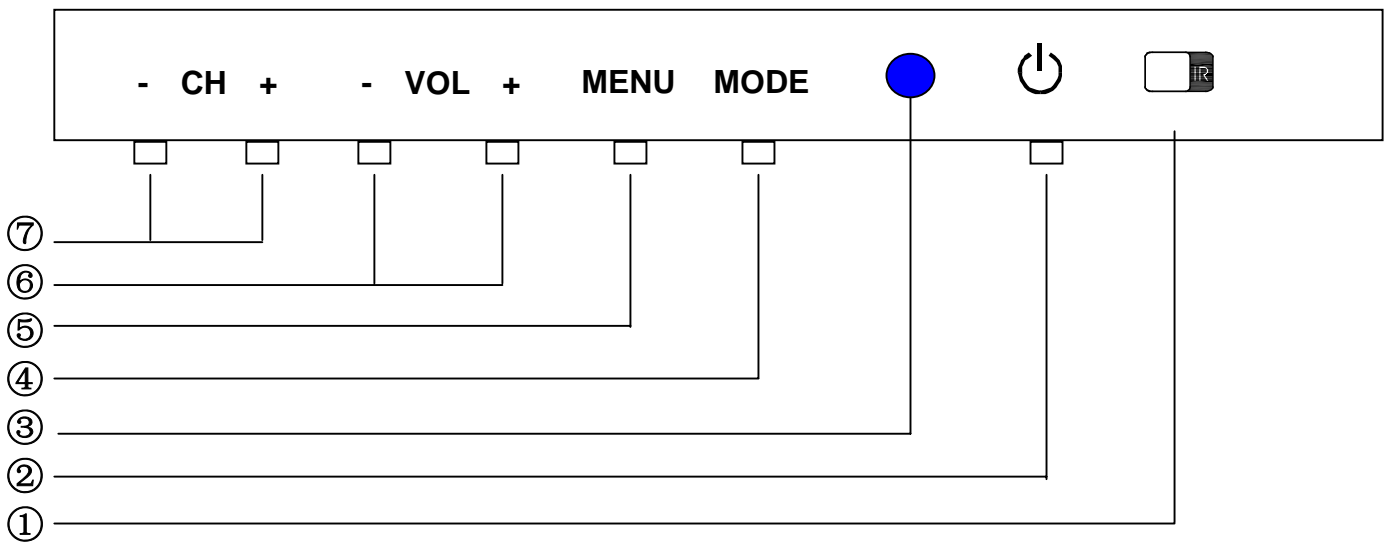
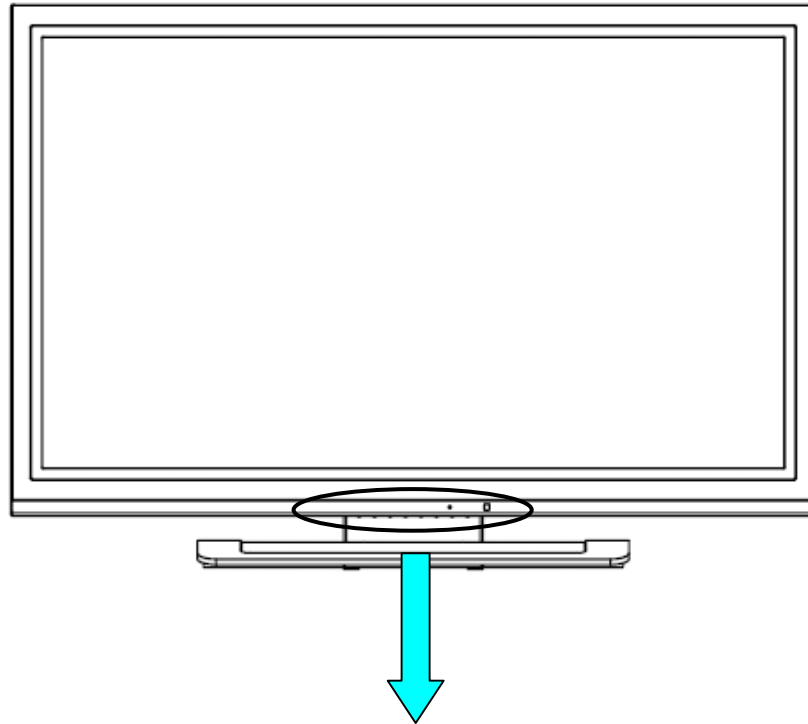

Front Panel Control



①		IR: Remote Control Sensor.
②		Power switch: Press to power on or power off the TV set.
③		LED: Power Indicator.
④	MODE	Mode: Press to select input signal modes or use as Enter in Menu operation.
⑤	MENU	Menu: Press to enter Menu or exit Menu.
⑥	- VOL +	Left: Press to decrease the sound volume level or move Left in Menu operation. Right: Press to increase the sound volume level or move Right in Menu operation.
⑦	- CH +	Down: Press to select the next lower Programme number or move Down in Menu operation. Up: Press to select the next higher Programme number or move up in Menu operation.

Basic Installation

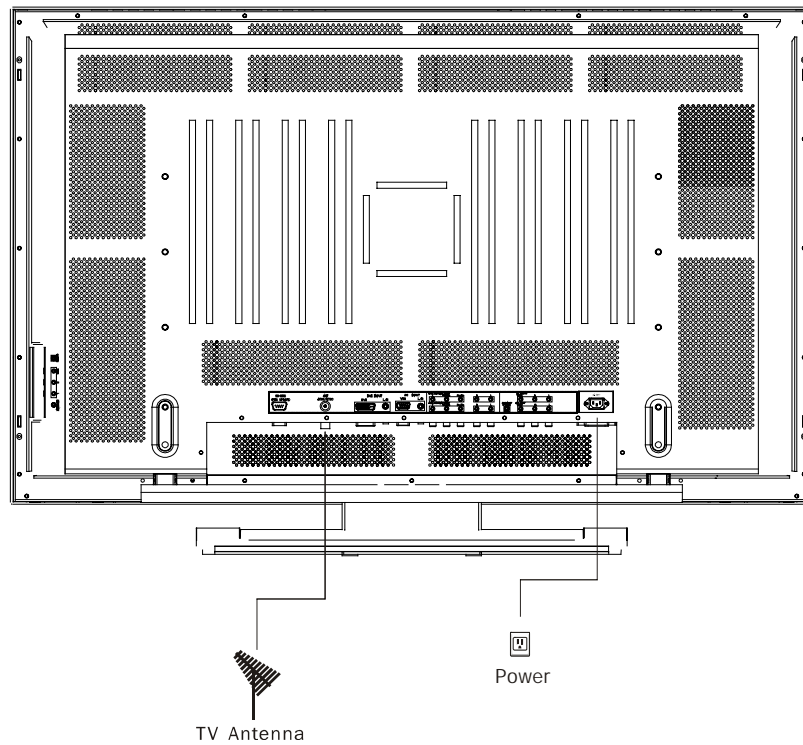

1. Connect TV Cable and Power Cord to this PDP TV Set.
2. Plug Power Cord to your home power outlet.
3. Check front panel LED for proper power connection:
Blue color indicates this TV set is powered on;
Red color indicates this TV set is in standby state.
4. Push POWER KEY on Remote Control or Power key on Front panel controls to switch the TV from stand by state to ON state.
This TV will power on and you can see display on screen within a few minutes.
5. Once you see information displayed on screen, press SOURCE button on Remote Control or MODE key on front panel continuously to select TV as input source. TV channel information will be displayed.
6. Use Auto channel search in "Setup Menu" to search all channels in your location. Refer to page 8 for "Setup Menu" operation procedure.
7. After Auto channel search is completed, press "CH+" or "CH-" key on remote control to select the next lower or higher channel.
Refer to the following pages for operating procedures:
 - Remote Control – page 7.
 - Setup Menu – page 8.
 - TV Channel Arrangement – page 11.

POWER KEY



Ch14.0

12:00AM

- TV channel information

Remote Control Function

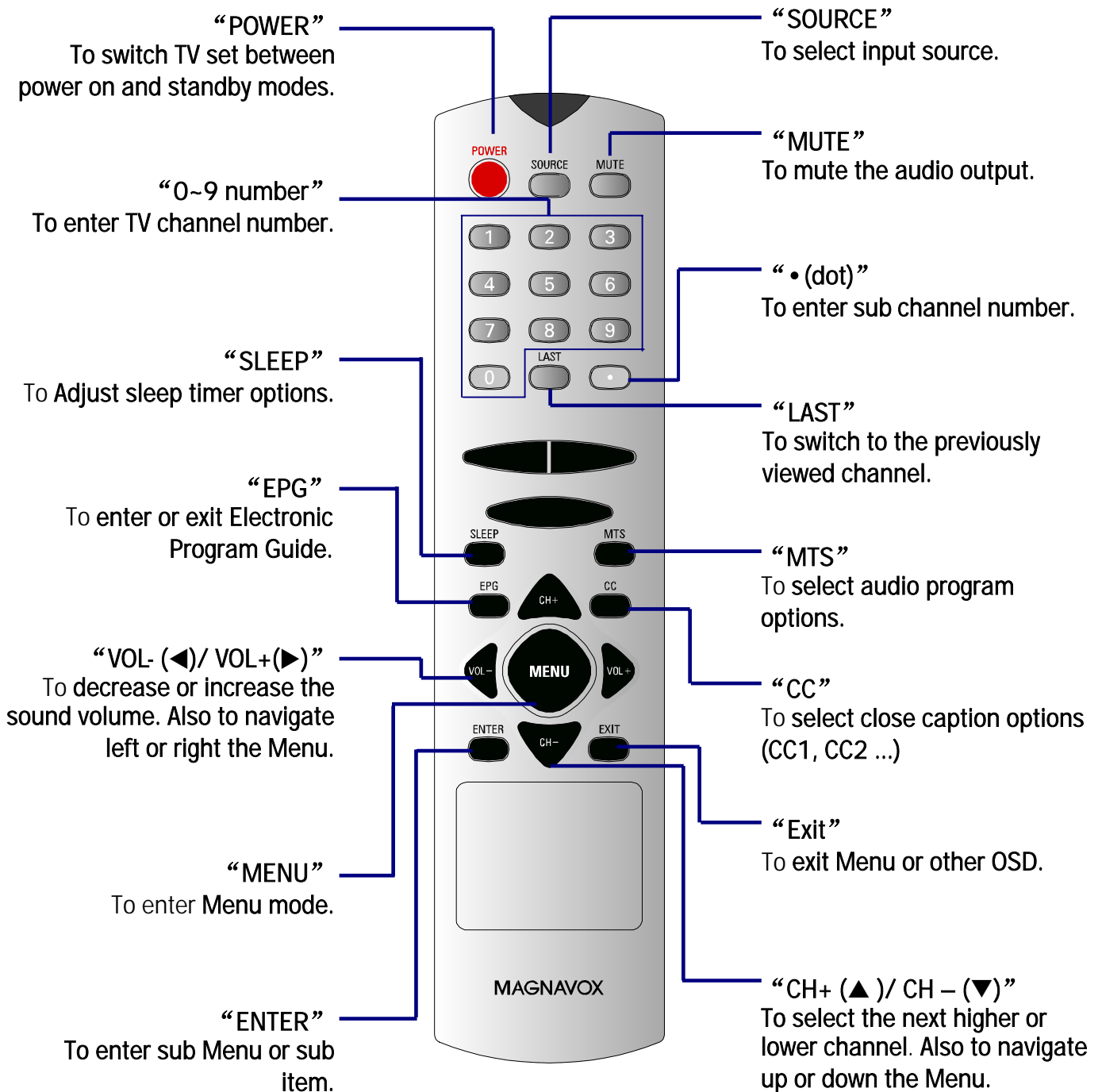

OSD Menu Descriptions

Main Menu

1. Press "MENU" key on remote control
2. Press "Up" or "Down" to move the cursor up and down the sub menu list.
3. Press "Left" or "Right" to select sub menu item.
4. Press "Enter" to enter sub-item then use "Up" or "Down" to adjust.

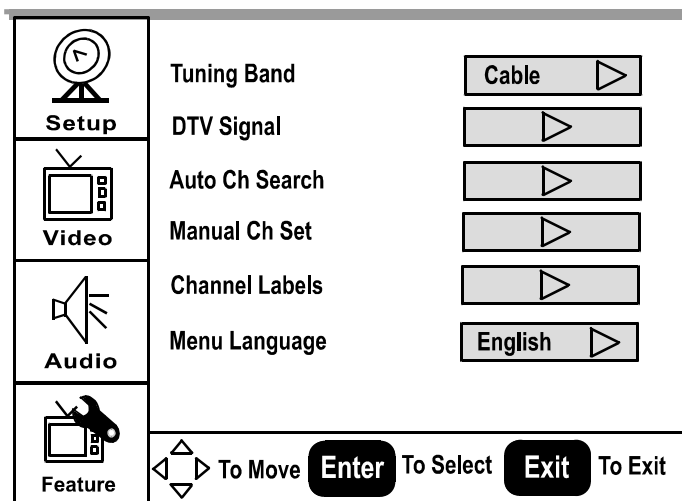

Setup Menu

1. Tuning Band: Select TV signal source between Air and Cable. Select Cable if you are connecting to a cable box and select Air if you are directly connecting to the antenna.
2. DTV Signal: Display signal strength to aid antenna adjustment.
3. Auto Ch Search: Automatically scan and store all TV channels.
4. Manual Ch Set: Enter channel setup table.
5. Channel Labels: Display and edit channel names.
6. Menu Language: Select language for menu (English or Español).

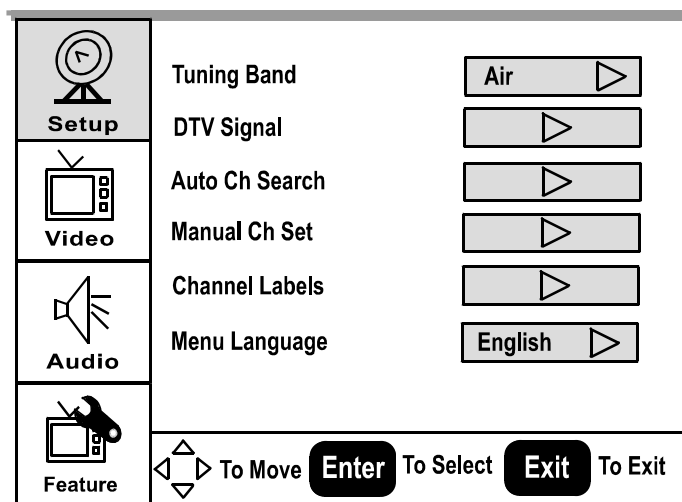

DTV signal menu indicates signal strength in real-time.

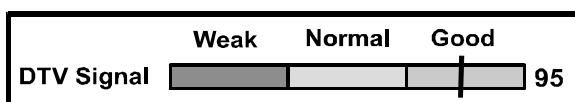

Auto channel scan menu displays channel number being scanned.

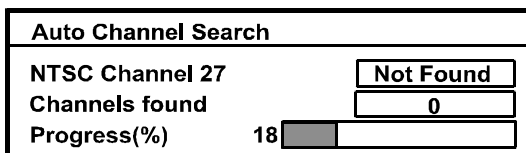

Manual Channel Set Menu
Displays all the channel numbers that are found.
Tune either

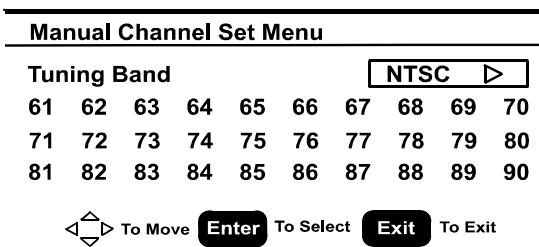

Channel Labels Menu allows user labeling.

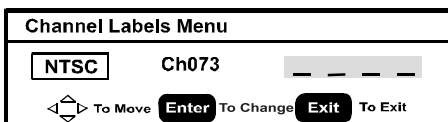

OSD Menu Descriptions

Video Menu

1. Press "▲" or "▼" to move the cursor up or down the sub-item list.
2. Press "Enter" to enter the highlighted sub-item menu.
3. Press "◀" or "▶" to adjust the value of the sub-item.
4. Press "Enter" again to exit the sub-item.

Contrast: Contrast adjustment, 0 ~ 100.

Brightness: Brightness adjustment, 0 ~ 100.

Color: Color chroma adjustment, 0 ~ 100.

Tint: Tint adjustment, 0 ~ 100.

Aspect Ratio: Aspect Ratio selection.

Normal → Zoom → Wide → Cinema.

Settings: Restore default setting.

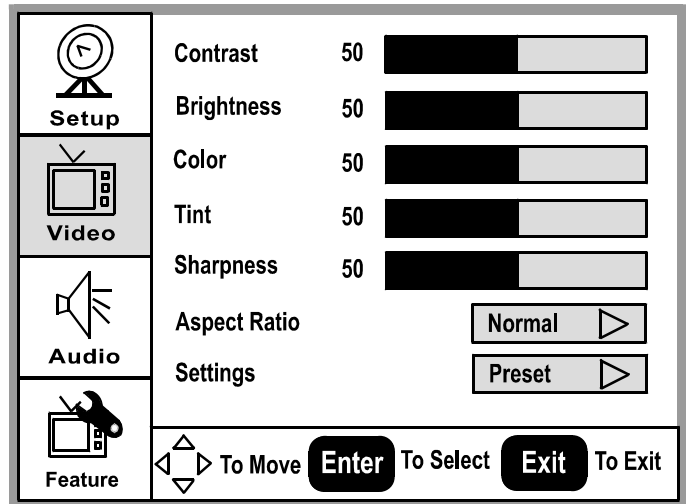

Audio Menu

1. Press "▲" or "▼" to move the cursor up or down the sub-item list.
2. Press "Enter" to enter the highlighted sub-item menu.
3. Press "◀" or "▶" to adjust the value of the sub-item.
4. Press "Enter" again to exit the sub-item.

Audio Language:

English → Español → Français.

Bass: Bass adjustment, 0 ~ 100.

Treble: Treble adjustment, 0 ~ 100.

Balance: Balance adjustment, 0 ~ 100.

Restore Default: Restore Audio Language, Treble, Base, and Balance setting to default.

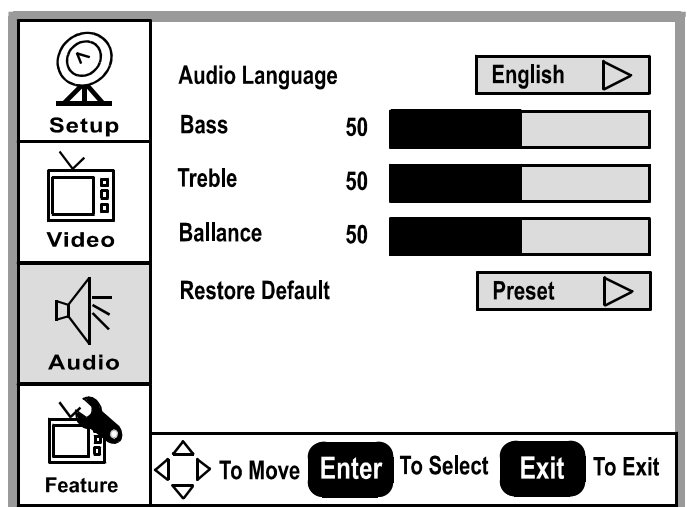

OSD Menu Descriptions

Feature Menu

1. Press "▲" or "▼" to move the cursor up or down the sub-item list.
2. Press "Enter" to enter the highlighted sub-item menu.
3. Press "◀" or "▶" to adjust the value of the sub-item.
4. Press "Enter" again to exit the sub-item.

Time Set : Select your region for the TV to update the time.

Sleep Timer: Select minutes into standby
Off → 30 → 60 → 90.

Password Set: Enter and change Parental Control Password.

Parental Control: Setup TV and Movie rating controls.

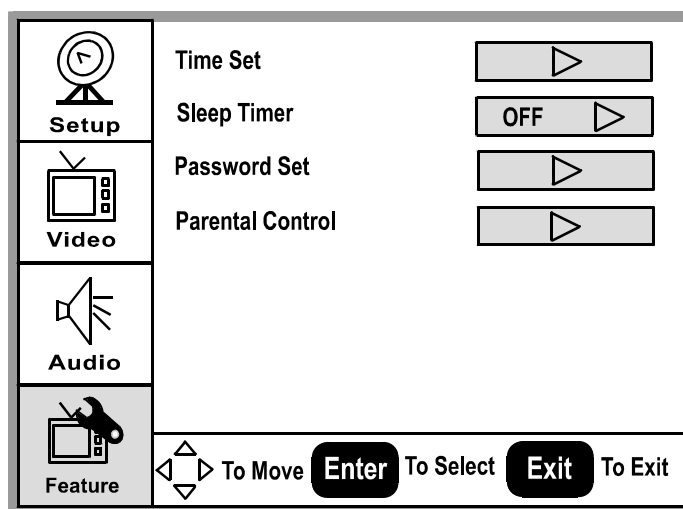

Parental Control Menu: Controls viewing of rated TV and Movie programs.

Note: Need password to change settings.

Initial Default password is: 0000.

Important : If you have forgotten your Password

Use the code [0711] to enter into the Password Set menu item to change your password.

You can also use the code [0711] to change your Parental Controls settings.

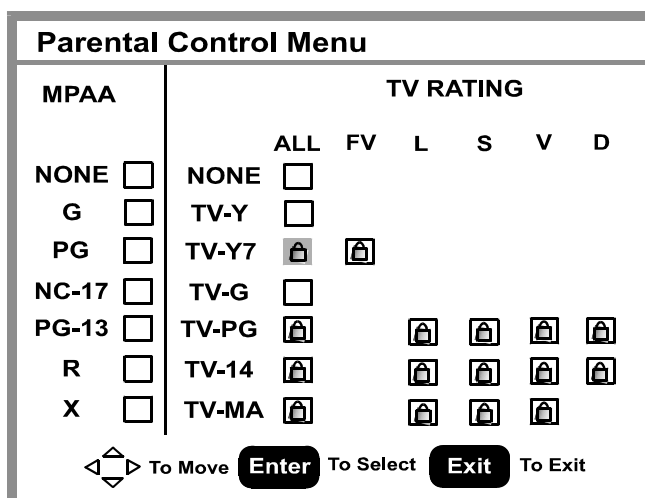

OSD Menu Descriptions

Closed Captions

1. Press "CC" key on remote control to select closed captions mode.
NTSC TV: Off → CC1 → CC2 → ...
ATSC TV: Off → CS1 → CS2 → ...
2. Select desired closed caption mode.

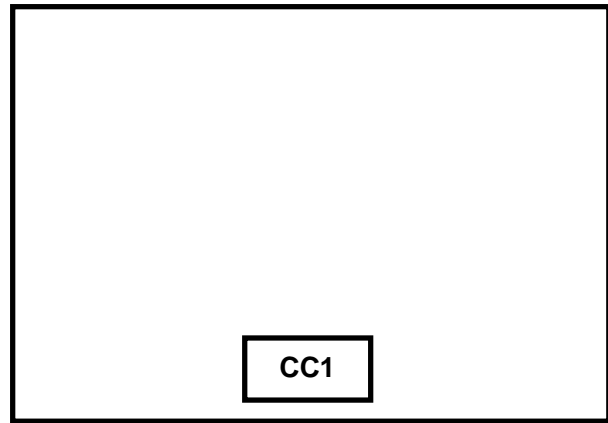

- NTSC TV

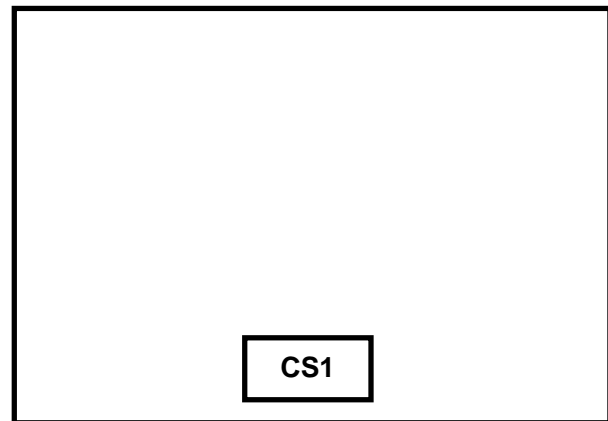

- ATSC TV

EPG

Press the "EPG" key on the remote control to display the Electronic Program Guide (EPG). A message window will be displayed on screen.

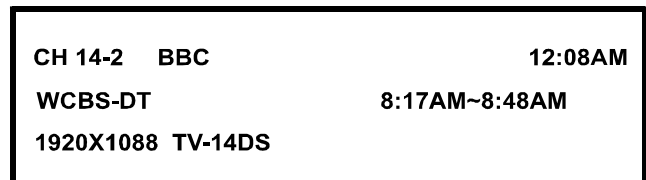

- EPG Message Window

TV channel arrangement

Each digital channel may comprise of several sub-channels.

To select a digital channel using the remote control:

1. Enter main channel number.
2. Press the "•" key.
3. Enter the sub-channel number.



Specifications

NOTE:

*This model complies with the specifications listed below.

*Designs and specifications are subject to change without notice.

*This model may not be compatible with features and/or specifications that may be added in the future.

Television System:

NTSC standard

ATSC standard (8VSB)

Channel Coverage:

VHF: 2 through 13

UHF: 14 through 69

Cable TV: Mid band (A-8 through A-1, A through I)

Super band (J through W)

Hyper band (AA through ZZ, AAA, BBB)

Ultra band (65 through 94, 100 through 125)

Power Source:

100 -240V, 50/60 Hz

Power Consumption

450 W (on average)

1 W in standby mode

(power cord plugged in and power OFF)

Audio Power

5 W + 5 W, Internal Speaker

Video/Audio Terminals:

Side AV include 1 Group:

S-Video/Video/Audio Input

Rear AV include 1 Group:

S-Video/Video/Audio Input

S-VIDEO INPUT:

Y : 1 V(p-p), 75 ohm, negative sync.

C : 0.286 V(p-p) (burst signal), 75 ohm

VIDEO/AUDIO INPUT:

VIDEO: 1 V(p-p), 75 ohm, negative sync.

AUDIO: 150 mV(rms)

Video/Audio Output:

VIDEO: 1 V(p-p), 75 ohm, negative sync

AUDIO: 150 mV(rms)

NOTE: This TV does not provide ATSC TV/S-VIDEO/HD/VGA/DVI Output.

Component INPUT:

Rear Component include 2 Groups:

Y : 1V(p-p), 75 ohm

Pr/Cr: 0.7 V (p-p), 75 ohm

Pb/Cb: 0.7 V (p-p), 75 ohm

AUDIO: 150 mV (rms)

Suggested resolutions: 1080i, 480p, 480i, 720p

DVI Terminals:

DVI INPUT:

Rear DVI include 1 DVI-D Input

HDCP compliant

E-EDID compliant

Suggested scan rates: 1080i/60Hz

480p/60Hz

720p/60Hz

VGA Terminals:

VGA INPUT:

Rear VGA include 1 D-SUB 15 Pin Input

E-EDID compliant

Suggested scan rates: 640X480/60Hz,

800 X 600/60Hz,

1024X768/60Hz

Dimensions:

Without Stand: Width: 1038 mm

Height: 660 mm

Depth: 82 mm

Include Stand: Width: 1038 mm

Height: 726.5 mm

Depth: 270mm

Weight:

35.5 kg (Without Stand)

43 kg (With Stand)

Supplied Accessories:



1pcs power cord

1pcs remote control

(with two *AAA*sized alkaline batteries)

Wall Mounting : Optional

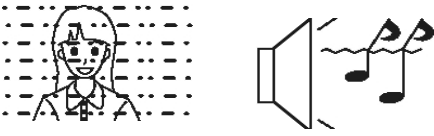
Troubleshooting

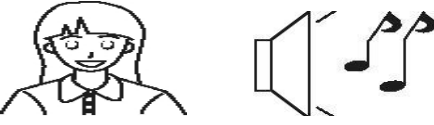
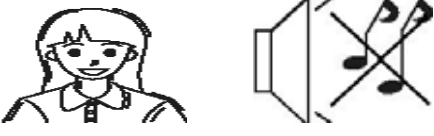
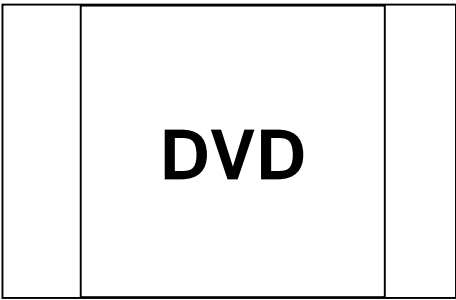
Symptoms	Checks
<p>Some channels are missing / are not found</p>	<ul style="list-style-type: none"> • Go to the Setup Menu (Menu→Setup) and install the channels again, searching Air/Cable as appropriate.
 <p>No Picture, No Sound</p>	<ul style="list-style-type: none"> • Check the power cord and power outlet. • Check whether the TV power switch is on. • Verify the front panel LED is showing blue color. • Check connections for the selected input source. • Verify that external signal for the selected input is active. • Check Video/Audio settings.
 <p>Interference, Noisy</p>	<ul style="list-style-type: none"> • Check antenna connection, aerial location, and direction. • Check and relocate nearby electrical appliances. • Check fluorescent lights. • Check cars/motorcycles.
 <p>Distorted picture, Noisy</p>	<ul style="list-style-type: none"> • Check antenna connection, aerial location, and direction • Re-scan Channels.
 <p>No Colour, Normal Sound</p>	<ul style="list-style-type: none"> • Check whether colour setting is at minimum. • Adjust video menu picture settings or reset to default.
 <p>Normal Colour, No Sound</p>	<ul style="list-style-type: none"> • Check audio input connections. • Check whether TV audio is in MUTE mode. • Adjust audio volume to audible level.
<p>Some parts of the screen do not light up</p>	<p>The plasma TV panel is manufactured using an extremely high level of precision technology, however, sometimes some parts of the screen may be missing picture elements or have luminous spots. This is not a malfunction.</p>
<p>After-images appear</p> 	<p>Do not allow a still picture to be displayed for an extended period, as this can cause a permanent after-image to remain on the Plasma TV.</p> <p>Examples of still pictures include logos, video games, computer images, and Teletext.</p> <p>Note:</p> <p>The permanent after-image on the Plasma TV resulting from fixed image use is not an operating defect and as such is not covered by the Warranty.</p> <p>This product is not designed to display fixed images for extended periods of time.</p>

MAGNAVOX Limited Warranty

One (1) Year Labor & One (1) Year Parts & One (1) Year Display Repair

MAGNAVOX warrants this product against defect in material or workmanship, subject to any conditions set forth as follows:

PROOF OF PURCHASE:

You must have proof of the date of purchase to receive repair on the product. A sales receipt or other document showing the product and the date that you purchased the product as well as the authorized retailer included, is considered such proof.

COVERAGE:

(If this product is determined to be defective)

LABOR: For a period of one (1) year from the date of purchase, Magnavox will repair or replace the product, at its option, at no charge, or pay the labor charges to any Magnavox authorized service center. After the period of one (1) year, Magnavox will no longer be responsible for charges incurred.

PARTS: For a period of one (1) year from the date of purchase, Magnavox will supply, at no charge, new or rebuilt replacement parts in exchange for defective parts. Magnavox authorized service centers will provide removal and installation of the parts for one (1) year.

DISPLAY: For a period of one (1) year from the date of purchase, Magnavox will supply, at no charge, a new or rebuilt active display device in exchange for the defective display. Magnavox authorized service centers will provide removal and installation of the parts under the specified labor warranty. (PTV screens carry a thirty (30) day replacement warranty.)

EXCLUDED FROM WARRANTY COVERAGE

Your warranty does not cover:

- Labor charges for installation or setup of the product, adjustment of customer controls on the product, and installation or repair of antenna systems outside of the product.
- Product repair and/or part replacement because of improper installation, connections to improper voltage supply, abuse, neglect, misuse, accident, unauthorized repair or other cause not within the control of Magnavox.
- A product that requires modification or adaptation to enable it to operate in any country other than the country for which it was designed, manufactured, approved and/or authorized, or repair of products damaged by these modifications.
- Damage occurring to product during shipping when improperly packaged or costs associated with packaging
- Product lost in shipment and no signature verification of receipt can be provided.
- A product used for commercial or institutional purposes (including but not limited to rental purposes).
- Products sold AS IS or RENEWED.

TO OBTAIN WARRANTY SERVICE IN THE U.S.A., PUERTO RICO, OR U.S. VIRGIN ISLANDS...

Contact Magnavox Customer Care Center at:
1-800-705-2000

TO OBTAIN WARRANTY SERVICE IN CANADA...

1-800-661-6162 (French Speaking)
1-800-705-2000 (English or Spanish Speaking)

REPAIR OR REPLACEMENT AS PROVIDED UNDER THIS WARRANTY IS THE EXCLUSIVE REMEDY FOR THE CONSUMER. MAGNAVOX SHALL NOT BE LIABLE FOR ANY INCIDENTAL OR CONSEQUENTIAL DAMAGES FOR BREACH OF ANY EXPRESS OR IMPLIED WARRANTY ON THIS PRODUCT. EXCEPT TO THE EXTENT PROHIBITED BY APPLICABLE LAW, ANY IMPLIED WARRANTY OF MERCHANTABILITY OR FITNESS FOR A PARTICULAR PURPOSE ON THIS PRODUCT IS LIMITED IN DURATION TO THE DURATION OF THIS WARRANTY.

Some states do not allow the exclusion or limitation of incidental or consequential damages, or allow limitations on how long an implied warranty lasts, so the above limitations or exclusions may not apply to you. In addition, if you enter into a service contract agreement with the MAGNAVOX partnership within ninety (90) days of the date of sale, the limitation on how long an implied warranty lasts does not apply.

This warranty gives you specific legal rights. You may have other rights which vary from state/province to state/province.

Magnavox, P.O. Box 671539, Marietta, GA. 30006-0026

(Warranty: 4835 710 28275)