



**PRACTICAL USER'S GUIDE
FOR THE DIMPLEX 36" OUTDOOR
ELECTRIC FIREPLACE**

**MODEL NUMBER:
DFO3607**

Serial Number _____

Model Number _____

CAT Number _____

Quality checked by:

Valued Customer,

We are pleased that you have chosen to purchase an electric fireplace manufactured by Dimplex North America Ltd. Over the years, valuable memories will occur around the warmth and comfort of your hearth. Thank you for allowing our product to be the backdrop for those special moments.

QUICK REFERENCE GUIDE FOR THE DIMPLEX ELECTRIC FIREPLACE

- 1. Prior to the first use of the fireplace verify the following:**
 - **Are the circuit breakers for the socket the unit uses on?**
- 2. The information regarding the model of your fireplace can be found on the rating plate. See Page 2 for location.**
- 3. If you have any technical questions regarding the operation or service of your fireplace have your Model and Serial Number ready, and contact Dimplex North America technical support at 1-888-DIMPLEX (1-888-346-7539) before returning the product to the point of purchase.**

CONTENTS

PAGE 1	Important Instructions
PAGE 2	Unpacking Instructions
PAGE 3	Model and Serial Number Information
PAGE 4	Site Selection and Preparation
PAGE 5	Fireplace Installation
PAGE 5	Operation
PAGE 7	Maintenance
PAGE 8	Stereo Instructions
PAGE 13	Warranty

IMPORTANT INSTRUCTIONS

SAVE THESE INSTRUCTIONS

PLEASE RETAIN THIS USER'S GUIDE FOR FUTURE REFERENCE

When using electrical appliances, basic precautions should always be followed to reduce the risk of fire, electric shock, and injury to persons, including the following:

1. Read all instructions before using the electric fireplace.
2. Always unplug the electric fireplace when not in use.
3. Do not operate any unit with a damaged cord or plug, or if the electric fireplace has been dropped or damaged in any manner. Return unit to authorized service facility for examination, electrical or mechanical adjustment, or repair.
4. Do not run the cord under carpeting. Do not cover cord with throw rugs, runners, or the like. Arrange cord away from traffic area and where it will not be tripped over.
5. To disconnect the unit, turn the controls off, then remove the plug from the outlet.
6. Do not modify the electric fireplace. Use it only as described in this manual. Any other use not recommended by the manufacturer may cause fire, electric shock or injury to persons.
7. Do not burn wood or other materials in the electric fireplace.
8. Do not strike the fireplace glass.
9. Always use a certified electrician should new circuits or outlets be required.
10. Always use properly grounded, fused and polarized outlets.
11. Disconnect all power supply before performing any cleaning, maintenance or relocation of the unit.
12. Do not use a pressure washer to clean unit.
13. When transporting or storing the unit and cord, keep in a dry place, free from excessive vibration and store so as to avoid damage.

NOTE: Procedures and techniques that are considered important enough to emphasize.

CAUTION: Procedures and techniques which, if not carefully followed, will result in damage to the equipment.

WARNING: Procedures and techniques which, if not carefully followed, will expose the user to the risk of fire, serious injury, illness or death.

UNPACKING INSTRUCTIONS

1. Remove firebox from carton.
2. Carefully lay unit on it's back.
3. Remove screws from the left and right side of the front glass lower support.
4. Carefully insert the tip of a slot screwdriver between the glass edge and either the left or right side trim.
5. Using the screwdriver as a lever, gently apply pressure in a downward motion, forcing the edge of the glass up.
6. Remove packing foam from the top of the log set.
7. Pull the front edge of the plastic ember bed or plastic grate up and forward until the rear tab releases from the ledge located at the bottom.
8. Remove packing material from around the log set.
9. Clean front glass if needed.
10. Re-assemble logset and front glass.

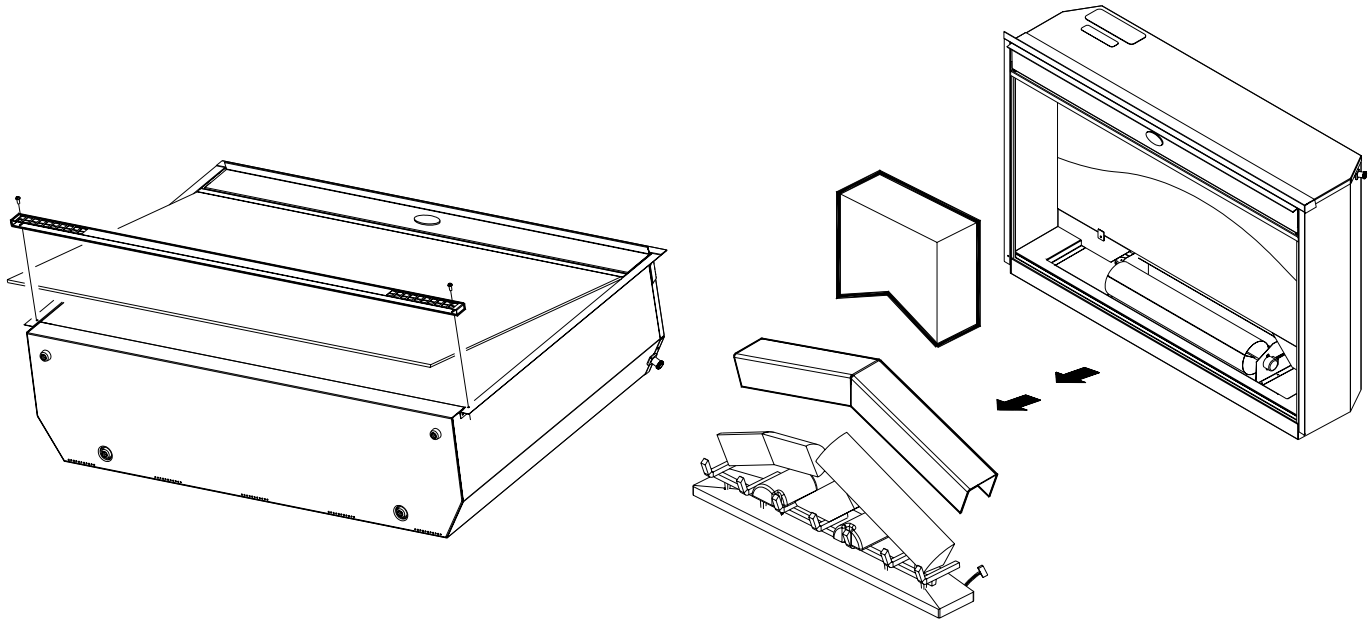

IMPORTANT INSTRUCTIONS

If you have any questions regarding our products please have the product model and serial numbers available upon calling Dimplex customer service or technical support. To locate the model and serial number labels see below (Figure 1). Record the Model number, Serial number, and CAT number on the front cover of this manual for future reference.

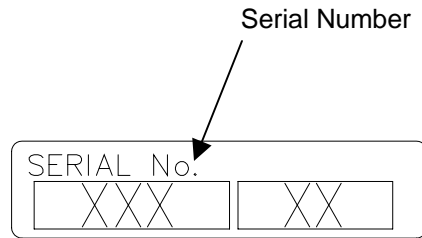
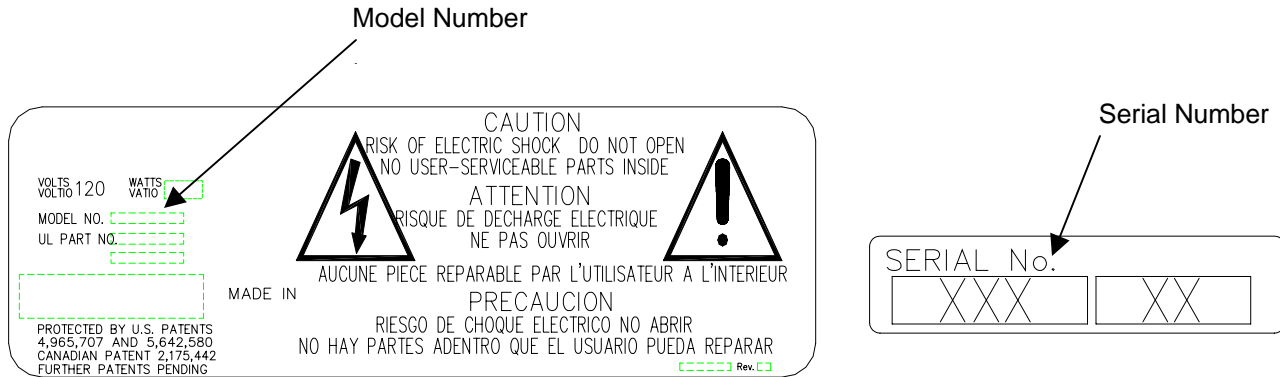

Serial Number Model Number

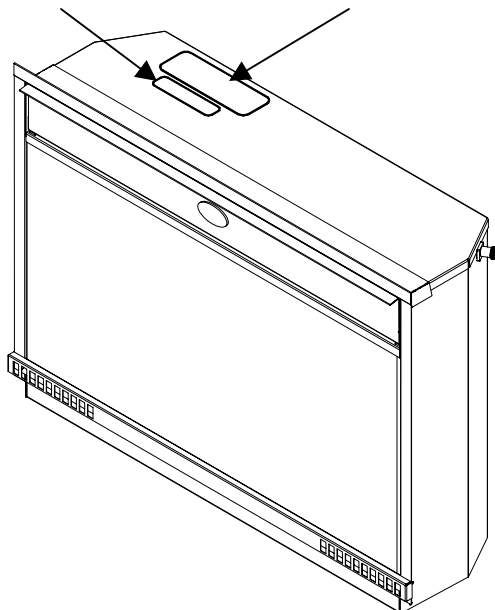

Firebox

Model Number

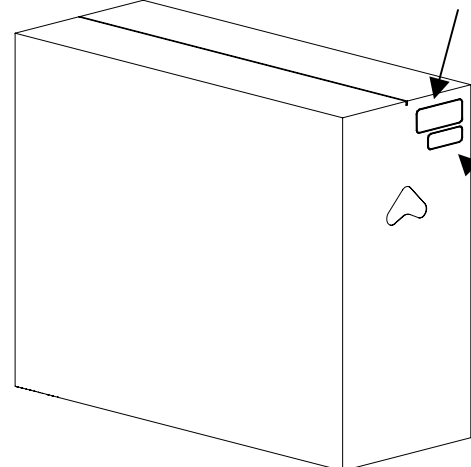

Serial Number

Carton

Figure 1

NOTE 1

A 15amp, 120 volt outdoor GFI is required. Additional appliances on the same circuit may exceed the current rating of the circuit breaker.

WARNING

Ensure the power cord and transformer are not installed so that it is pinched or against a sharp edge and ensure that the cord and transformer are stored or secured to avoid tripping or snagging to reduce the risk of fire, electric shock or injury to persons.

Construction and electrical outlet wiring must comply with local building codes and other applicable regulations to reduce the risk of fire, electric shock and injury to persons.

Do not attempt to wire your own new outlets or circuits. To reduce the risk of fire, electric shock or injury to persons, always use a licensed electrician.

SITE SELECTION AND PREPARATION

This section provides instructions for selecting a location and preparing the site to install the fireplace into your Dimplex mantel surround.

1. Select a suitable location.
2. For ease of electrical hook up you may wish to locate the fireplace near an existing outlet. (refer to NOTE 1).

NOTE

The dimensions of the fireplace are 37.60" wide X 26.25" high X 11" deep. The viewing area is 36" wide and 19.25" high.

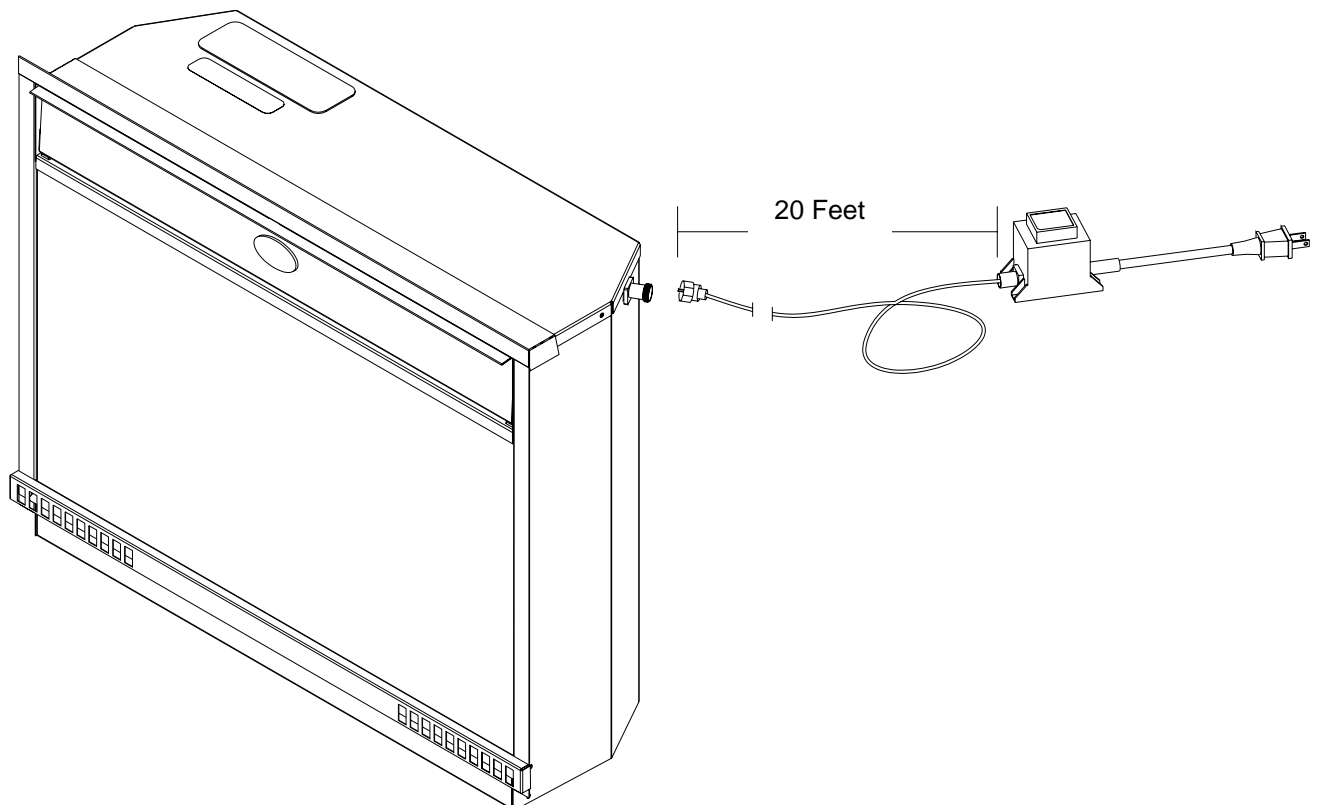

FIREPLACE INSTALLATION

11. Install the fireplace assembly only into the Dimplex outdoor mantel.
(refer to mantel assembly instructions)

OPERATION

ELECTRIC FIREPLACE MANUAL CONTROL

The manual controls for the firebox are located in the upper right hand corner behind the access panel. To access the controls, open the upper access panel by pulling forward and down.

To locate controls refer to Figure 2.

NOTE: The main on/off switch, flame action and flame brightness controls are always illuminated as long as the unit is plugged in.

A. Main On/Off Switch

The ON/OFF SWITCH supplies power to all fireplace functions (Flames/Flame speed Control/Dimmer Control).

B. Flame Action Control

Press the up or down arrow to adjust the flame speed to the desired level.

C. Flame Brightness Control

Press the up or down arrow to increase or decrease the brightness of the overhead lights.

D. Storage Compartment

A convenient location to place your CD's or MP3 player.

E. Stereo/MP3/CD Player

This fireplace is equipped with a built-in stereo.(refer to page 8 for operation)

NOTE: This unit does not have a heat option

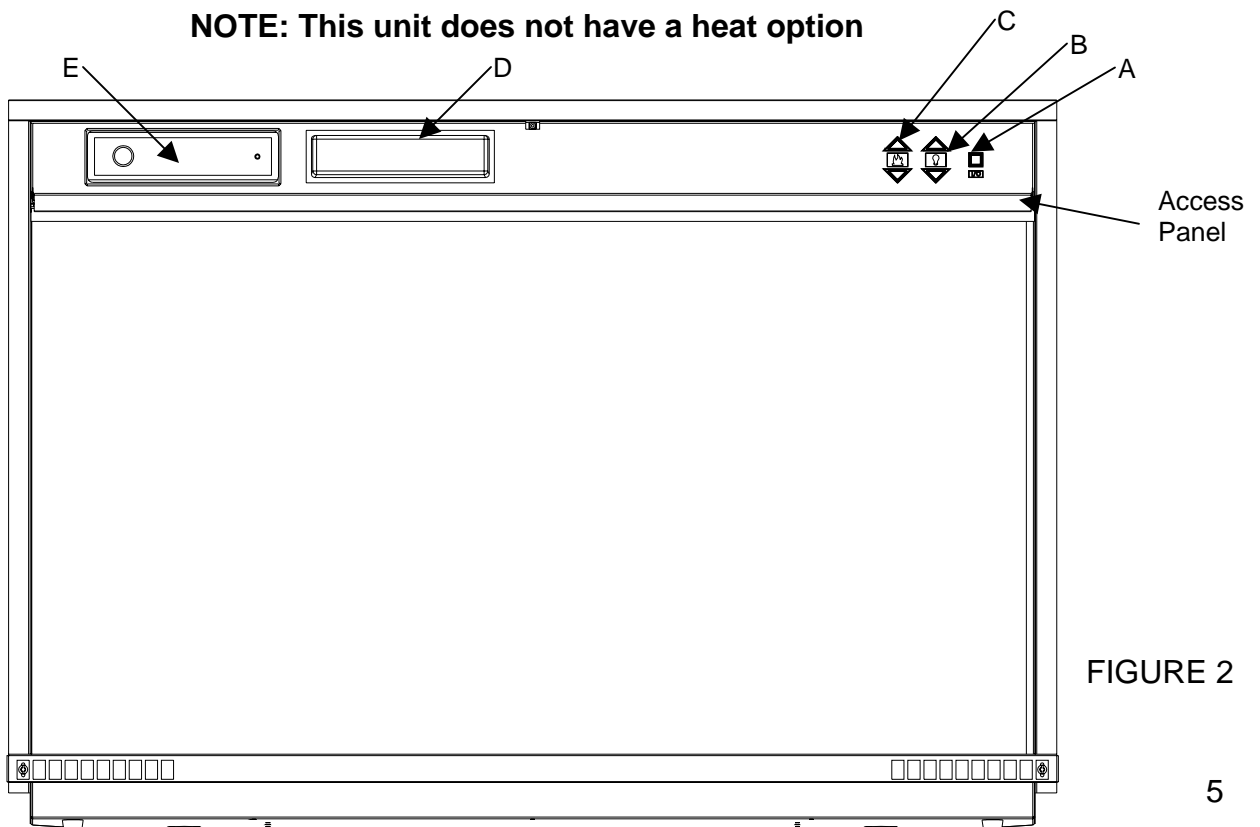

FIGURE 2

OPERATION

The fireplace is supplied with an integrated radio frequency on/off remote control. The remote control has a range of approximately 50 feet (15.25m), it does not have to be pointed at the fireplace and can pass through most obstacles (including walls).

To operate, push the ON button to turn fireplace on, push the OFF button to turn the fireplace off. This remote does not control the stereo system.

BATTERY REPLACEMENT (fig. 3)

To replace the battery, slide battery cover open on the hand held transmitter. Correctly install one 12 volt (A23) battery in the battery holder. Close the batter cover.

Store the fireplace remote in a dry location where temperature is between 15 C to 35C.

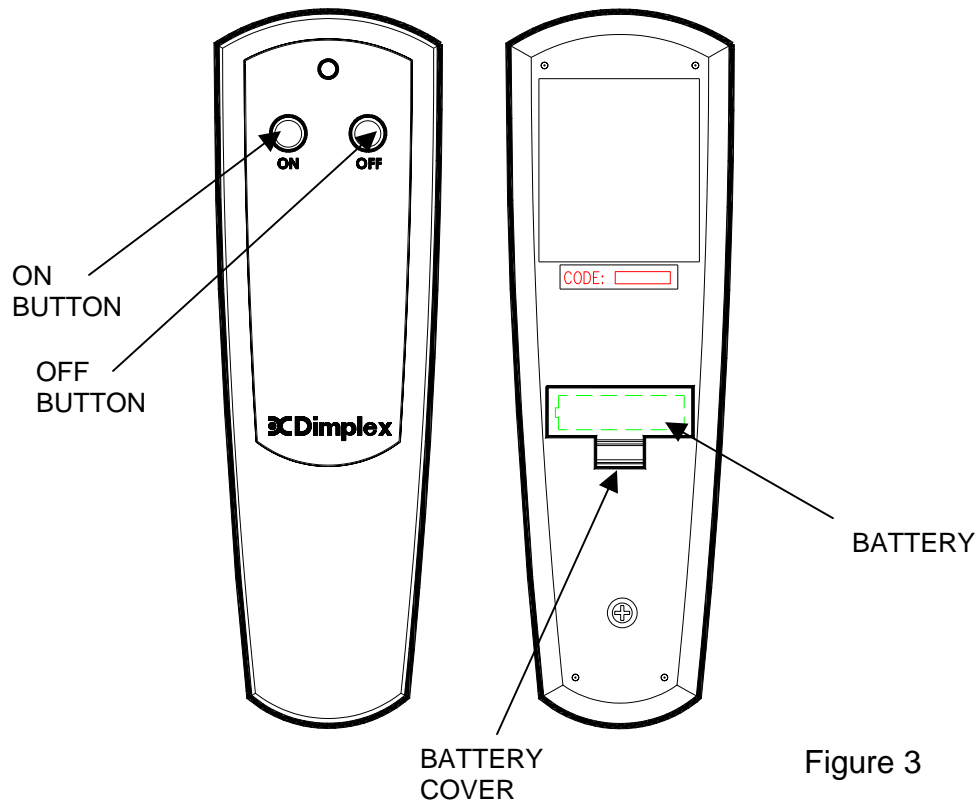

Figure 3

MAINTENANCE

WARNING

Disconnect power before attempting any maintenance or cleaning to reduce the risk of fire, electric shock or damage to persons.

GLASS CLEANING

The glass is cleaned in the factory during the assembly operation. During shipment, installation, handling, etc., the glass may collect dust particles; these can be removed by dusting lightly with a clean dry cloth.

To remove fingerprints or other marks, the glass can be cleaned with a damp cloth. To prevent scratching, do not use abrasive cleaners or spray liquids on the glass surface.

SEASONAL CLEANING

To clean the glass or remove debris from inside unit.

NOTE: Gloves are required as edges may be sharp.

1. Unplug fireplace
12. Remove top from mantel.
13. Lift firebox out of mantel.
14. Lay firebox on it's back.
15. Remove screws from the left and right side of the front glass lower support. (Fig 4)
16. Carefully insert the tip of a slot screwdriver between the glass edge and either the left or right side trim.
17. Using the screwdriver as a lever gently apply pressure in a downward motion, forcing the edge of the glass up.

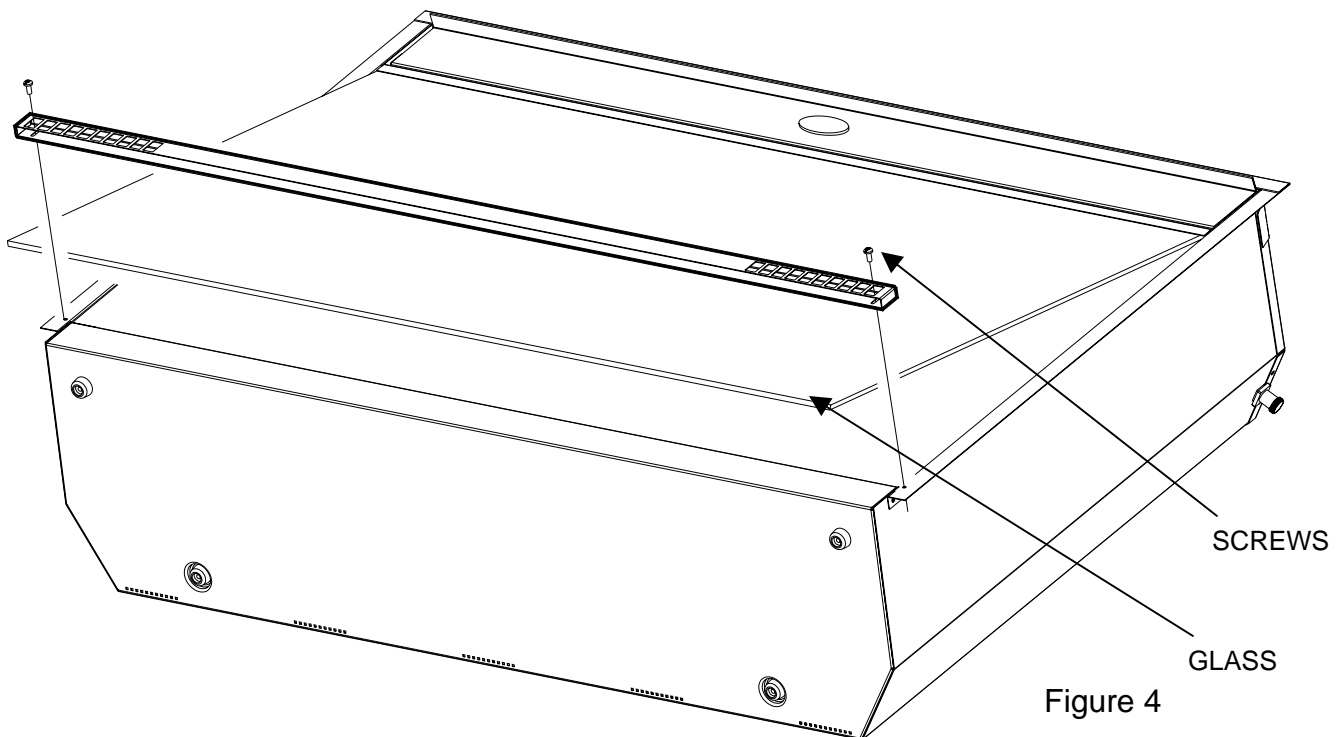

STEREO INSTRUCTIONS

IMPORTANT INSTRUCTIONS

1. Never repair the stereo unit yourself. In case of any failure, please turn off the power, and contact Dimplex North America. This unit is composed of many precision electronic components. The dismantling or repair may cause damage.
2. Keep the unit away from humidity, dust, steam, smoke, direct sunlight, etc. Do not use any chemical detergent on unit.
3. Use soft rag to clean the surface of the unit.
4. Store faceplate in dry areas where temperature is between -10 C to 60 C .
5. Prevent unit from falling or encountering any serious impact.
6. Close access panel when not in use, or after operation.

Control Panel Functions

- | | |
|-------------------------------------|------------------------------------|
| 1. Panel Open Button | 12. Play Button |
| 2. Eject Button | 13. Band Button |
| 3. Select Button | 14. Program-Preview/Search-Down |
| 4. Volume Adjustment | 15. Program-Next/Search-Up |
| 5. Clock Button | 16. Reset |
| 6. Radio Preset 1/Disc Introduction | 17. Preset-EQ |
| 7. Radio Preset 2/Disc Repeat | 18. Station Auto-Scan and Save Aps |
| 8. Radio Preset 3/Disc Random | 19. Auxiliary Button |
| 9. Radio Preset 4 | 20. Auxiliary Input Jack |
| 10. Radio Preset 5 | 21. Equal Loudness Compensation |
| 11. Radio Preset 6 | 22. Power Button |

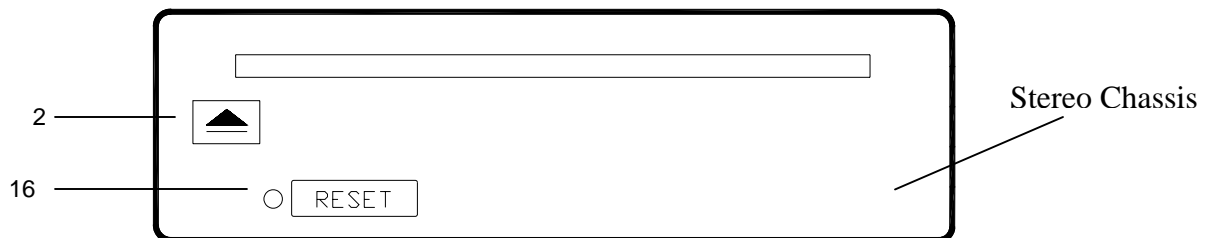
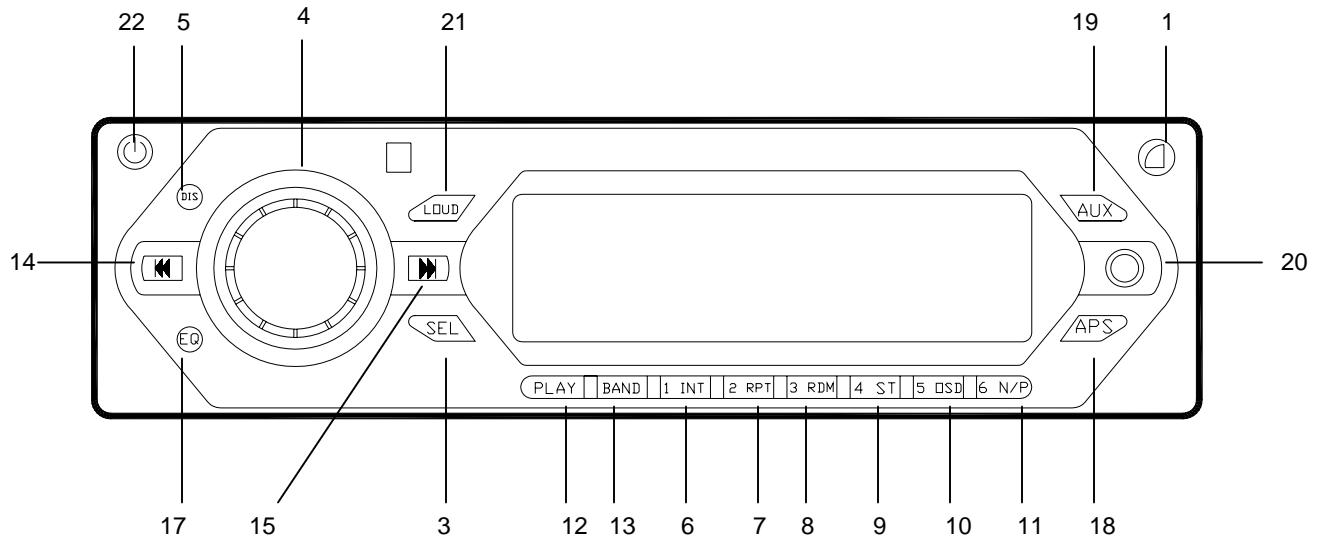







BASIC OPERATION



ON/OFF

Press the on/off button to power on and press it again to power off.
Press the on/off button to power the Radio CD and AUX/MP3 functions.

DIS: Display the clock and the clock adjustment

- (1) Connect the faceplate to the stereo chassis and power on; the LCD will display the radio frequency.
- (2) Press the , the LCD will display the current time; press and hold the  button and the hours on the LCD will flash.
- (3) Press the  or  button to set the hour and then press the  button again, the minute will flash. Press the  or  button to set the minute.
- (4) Lock the time memory by pressing the clock button after proper time is set. The flashing will stop and the player will again display the radio frequency 5 seconds later.



VOL UP/DOWN

To adjust volume up, turn the volume knob “clockwise” (max 63) or to adjust the volume down turn the volume knob “counter clockwise”(min 01). When the volume knob is turned the screen will display the volume level. When the volume is turned counter clockwise fully “mute” will be displayed on the screen.



EQ FUNTION

Press “EQ” button continuously and choose from three factory preset sound settings.

NOTE: If the factory EQ is activated the base and treble are inactive.



BAS

Press the SEL button **once** to enter the BAS mode and the screen will display the sign of “BAS”.

To adjust the base level up or down turn the volume knob “clockwise” to increase the base or “counter clockwise” to decrease the base.



TRE

Press the SEL button **twice** to enter the TRE mode and the screen will display the sign of “TRE”.

To turn the treble level up or down turn the volume knob “clockwise” to increase the treble or “counter clockwise” to decrease the treble.

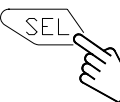

LEFT/RIGHT BALANCE

Press the SEL button **three** times or **once** (EQ Preset Mode) to enter the LEFT/RIGHT BALANCE mode. The screen will display “BAL”.

To adjust the balance left or right, turn the volume knob “clockwise” for the right speaker or “counter clockwise” for the left speaker.

FAD BALANCE



Press the SEL button **four** times or **twice** (EQ Preset Mode) to enter the FAD mode and the screen will display "FAD".

There are no rear speakers so this setting can stay at default or max out the front fade by turning the volume knob clockwise.

ERROR & RECOVERY

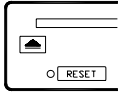

1. In case of any error during the process of radio or disc playing "ERROR" will appear on the screen, you will then have to restart the device.
2. If the sign of "ERROR" remains it is recommended that you press the RESET button with a fine tipped tool through the small hole located in the lower left corner of the stereo chassis.

CD/MP3: BASIC OPERATIONS

INSERT/EJECT: Press the  button on the panel, the faceplate will open. Select a disc and insert into the disc holder with the printed side facing up. Press EJECT to take the disc out of the holder. If the disc is not removed from the holder within 10 seconds it will automatically go back inside the holder. When the disc is taken out of the holder the stereo will automatically enter into radio (BAND) mode.

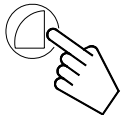

OPEN Button:



Press to open the front panel to access the CD.

PLAY/PAUSE





When a disc is in the disc holder press the PLAY button to play the disc. This function will also work when in the RADIO mode. To pause press the play button, the display will show "----"; press the play button again to resume play.

(1) NEXT SEARCH

In the PLAY mode press the  button to skip to the next track on the CD/MP3, the new track number will be displayed in the display. Press  for the desired track number.

(2) PREV SEARCH

In the PLAY mode press the  button to skip to the previous track on the CD/MP3, the previous track number will be displayed in the display. Press  for the desired track number.

(3) FAST FORWARD

In the PLAY mode press and hold the  button to fast forward through the current track, then release the button and press the  button to stop and play the current track.

(4) REWIND

In the PLAY mode press the  button to reverse through the current track. Release the button and press the  button to stop and play the current track.

INT: Browse Programs

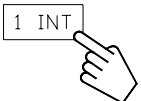

Press the INT button and the LCD will display the sign of "INT", the player will play the introduction (5 seconds) of each track on the disc. Press the INT button again to stop browsing and enter into normal play mode.

**RPT: Repeat Playing**





Press the RPT button, the LCD will display “RPT”. The player will continuously repeat the selected track. To cancel this function press the RPT button again.

**RDM: Play at Random**

Press the RDM button, the LCD will display “RDM”. This setting will play all tracks on the current CD randomly. Press RDM button again to cancel this selection.

RADIO OPERATION

STATION-SWITCH BAND

Press the “BAND” button to enter the radio mode. There are 3 FM bands (FM1, FM2, FM3), as well as AM1 and AM2. Each has 6 radio presets. In the radio mode, press the  button or  button to manually search upward or downward. Press the  button or  button for more than one second to automatically search for the next station.

STATION-PRESET Button

There are 6 STATION-PRESET buttons that you can save your favorite stations in each band. FM1, FM2, FM3 and AM1 and AM2. 30 stations may be stored in total.

STATION-SAVE Button

Press the BAND button to select the bands of the FM radio stations you want to save, including FM1, FM2, FM3, AM1 and AM2. Press the TUNE button to select your favorite station. Press one of the preset radio stations buttons (1 to 6) for more than 3 seconds; the station will then be stored in the selected preset radio station. To listen to one of the stations saved, press the preset button it was saved in.

Auto Scan/Auto Save of Station

When in radio mode press the “APS” button to automatically scan the preset stations. Each channel will be played for 5 seconds. During this process when you reach your favorite channel press the “APS” again to stop scanning. Press “APS” and hold for 3 seconds to automatically scan and save a station, this will cancel the original memory and re-save the stations with the strongest signals from 1 to 6. During this process press “APS” again to stop automatic saving.



Notes for Using CD

1. Keep the disc clean as possible.
2. Do not play damaged or deformed discs.
3. Keep the disc away from direct sunlight or high temperatures.
4. Put the disc in case after use.
5. Fingerprints or other smears left on the disc may affect sound quality. You may use a dry soft cloth to clean the disc surface. If necessary, you may also use a soft damp cloth to clean more stubborn smears or fingerprints.
6. Be sure to clean the disc from its center to edge rather than along the edge.

General Performance

Frequency Modulation

Tuning Range.....87.5 – 108MHz

Mid Frequency.....10.7MHz-0.3

Sensitivity of Noise Limit.....400db

Image Rejection.....40db

Amplitude Modulation

Tuning Range.....522-1620KHz

Mid Frequency.....455Hz-5

Sensitivity Noise Limit....below 32db

Image Rejection.....above 34db

CD

Laser.....semiconductor laser, Wavelength 780 NM

Frequency Sonority.....20Hz-20KHz

SNR.....>80 db

Harmonic Distortion.....<0.012% (1KHz)

Others

Output Power (10% THD).....2 x 25W

Power source voltage.....11-13.8V Negative Pole Earthed

Loudspeaker Impedance.....4-8 Ohm/Sound Channel

Installation Dimension.....172 (W) x 165 (D) x 50 (H) mm

Weight.....2.0kg

LIMITED WARRANTY

Products to which this limited warranty applies

This limited warranty applies to your newly purchased Dimplex outdoor fireplace or outdoor stove. This limited warranty applies only to purchases made in any province of Canada *except* for Yukon Territory, Nunavut, or Northwest Territories or in any of the 50 States of the USA (and the District of Columbia) *except* for Hawaii and Alaska. This limited warranty applies to the original purchaser of the Product only and is not transferable.

Products excluded from this limited warranty

Light bulbs are not covered by this limited warranty and are the sole responsibility of the owner/purchaser. Products purchased in Yukon Territory, Nunavut, Northwest Territories, Hawaii, or Alaska are not covered by this limited warranty. Products purchased in these States, provinces, or territories are sold AS IS without warranty or condition of any kind (including, without limitation, any implied warranties or conditions of merchantability or fitness for a particular purpose) and the entire risk of as to the quality and performance of the products is with the purchaser, and in the event of a defect the purchaser assumes the entire cost of all necessary servicing or repair.

What this limited warranty covers and for how long

Products covered by this limited warranty have been tested and inspected prior to shipment and, subject to the provisions of this warranty, Dimplex warrants such products to be free from defects in material and workmanship in respect to the fireplace components of this product for a period of **12 months**; and in respect to the compact-disc player, stereo speakers and stereo components of this product for a period of **90 days** from the date of the first purchase of the Product.

This limited warranty period also applies to any implied warranties that may exist under applicable law. Some jurisdictions do not allow limitations on how long an implied warranty lasts, so the above limitation may not apply to the purchaser.

What this limited warranty does not cover

This limited warranty does not apply to Products that have been repaired (except by Dimplex or its authorized service representatives) or otherwise altered. This limited warranty does further not apply to defects resulting from misuse, abuse, accident, neglect, incorrect installation, improper maintenance or handling, operation with an incorrect power source, fire or other circumstance outside of Dimplex's control including, without limitation, an Act of God.

What you must do to get service under this limited warranty

Defects must be brought to the attention of Dimplex Technical Service by contacting Dimplex at 1-888-[DIMPLEX](tel:1-888-DIMPLEX) (1-888-346-7539), or 1367 Industrial Road, Cambridge Ontario, Canada N1R 7G8. Please have proof of purchase, catalogue/model and serial numbers available when calling. Limited warranty service requires a proof of purchase of the Product.

What Dimplex will do in the event of a defect

In the event the Product or part covered by this limited warranty is proven to be defective in material or workmanship during, in the One Year Warranty or 90 Day Warranty period, as applicable, you have the following rights:

- Dimplex will in its sole discretion either repair or replace such defective Product or part without charge. If Dimplex is unable to repair or replace the Product or part, or if repair or replacement is not commercially practicable or cannot be timely made, Dimplex may, in lieu of repair or replacement, choose to refund the purchase price for the Product or part.
- Limited warranty service will be performed solely by dealers or service agents of Dimplex authorized to provide limited warranty services.
- The purchaser is responsible for removal and transportation of the Product or part (and any repaired or replacement Product or part) to and from the authorized dealer's or service agent's place of business.
- This limited warranty does not entitle the purchaser to on-site or in-home services. On-site or in-home services may be performed at the purchaser's specific request and expense at Dimplex's then-current rates for such services.
- Dimplex will not be responsible for, and the limited warranty services shall not include, any expense incurred for installation or removal of the Product or part (or any replacement Product or part) or any labour or transportation costs. Such costs shall be the purchaser's responsibility.

What Dimplex and its dealers and service agents are also not responsible for:

IN NO EVENT WILL DIMPLEX, OR ITS DIRECTORS, OFFICERS, OR AGENTS, BE LIABLE TO THE PURCHASER OR ANY THIRD PARTY, WHETHER IN CONTRACT, IN TORT, OR ON ANY OTHER BASIS, FOR ANY INDIRECT, SPECIAL, PUNITIVE, EXEMPLARY, CONSEQUENTIAL, OR INCIDENTAL LOSS, COST, OR DAMAGE ARISING OUT OF OR IN CONNECTION WITH THE SALE, MAINTENANCE, USE, OR INABILITY TO USE THE PRODUCT, EVEN IF DIMPLEX OR ITS DIRECTORS, OFFICERS, OR AGENTS HAVE BEEN ADVISED OF THE POSSIBILITY OF SUCH LOSSES, COSTS OR DAMAGES, OR IF SUCH LOSSES, COSTS, OR DAMAGES ARE FORESEEABLE. IN NO EVENT WILL DIMPLEX, OR ITS OFFICERS, DIRECTORS, OR AGENTS BE LIABLE FOR ANY DIRECT LOSSES, COSTS, OR DAMAGES THAT EXCEED THE PURCHASE PRICE OF THE PRODUCT.

SOME JURISDICTIONS DO NOT ALLOW THE EXCLUSION OR LIMITATION OF INCIDENTAL OR CONSEQUENTIAL DAMAGES, SO THE ABOVE LIMITATION OR EXCLUSION MAY NOT APPLY TO THE PURCHASER.

How State and Provincial law apply

This limited warranty gives you specific legal rights, and you may also have other rights which vary from jurisdiction to jurisdiction. The provisions of the United Nations Convention on Contracts for the Sale of Goods shall not apply to this limited warranty or the sale of Product covered by this limited warranty.



1-888-DIMPLEX
1-888-346-7539

1367 Industrial Road
Cambridge, Ontario
Canada, N1R 7G8