



Owner's Manual	4
Table of Contents	
Manual del usuario	34
Tabla de contenido	
Manuel d'instructions	60
Table des matières	

120 Hz
55"
class
54.6"
138.8 cm
diagonal/diagonale

1080p HDTV LCD
TV HD 1080p ACL



DP55441

Model No. / No. de Modelo / N° de modèle



**CONTAINS MERCURY LAMPS,
DISPOSE OF PROPERLY**



RECYCLING OF SANYO TELEVISIONS:

SANYO television customers should contact MRM Recycling at 888-769-0149 or visit their website at www.mrmrecycling.com regarding SANYO's waste management plan.



**CONTIENE LÁMPARAS DE
MERCURIO, DESECHAR
DE MANERA APROPIADA**



RECICLAJE DE TELEVISORES SANYO:

Clientes de SANYO televisores deben contactar a MRM Recycling al 888-769-0149 o visitar su sitio web en www.mrmrecycling.com respecto al plan de SANYO sobre manejo de desperdicios.





**CONTIENT DES LAMPES AU
MERCURE, À JETER DE
FAÇON APPROPRIÉE**



RECYCLAGE DES TÉLÉVISEURS:

Les clients de téléviseurs SANYO doivent contacter à MRM Recycling au 888-769-0149, ou visiter le site web à www.mrmrecycling.com en ce qui concerne le plan de SANYO sur le maniement de déchets.

Thank you for choosing SANYO. Please read all instructions to obtain maximum benefit of your product.

CAUTION	THIS SYMBOL INDICATES THAT DANGEROUS VOLTAGE CONSTITUTING A RISK OF ELECTRIC SHOCK IS PRESENT WITH THIS UNIT. 
RISK OF ELECTRIC SHOCK DO NOT OPEN	THIS SYMBOL INDICATES THAT THERE ARE IMPORTANT OPERATING AND MAINTENANCE INSTRUCTIONS IN THE OWNER'S MANUAL WITH THIS UNIT. 
CAUTION : TO REDUCE THE RISK OF ELECTRIC SHOCK, DO NOT REMOVE COVER (OR BACK). NO USER-SERVICEABLE PARTS INSIDE. REFER SERVICING TO QUALIFIED SERVICE PERSONNEL.	

WARNING: TO REDUCE THE RISK OF FIRE OR ELECTRIC SHOCK, DO NOT EXPOSE THIS APPLIANCE TO RAIN OR MOISTURE.

IMPORTANT SAFETY INSTRUCTIONS

1. Read these instructions.
2. Keep these instructions.
3. Heed all warnings.
4. Follow all instructions.
5. Do not use this apparatus near water.
6. Clean only with a dry cloth.
7. Do not block any ventilation openings. Install in accordance with the manufacturer's instructions.
8. Do not install near any heat sources such as radiators, heat registers, stoves or other apparatus (including amplifiers) that produce heat.
9. Do not defeat the safety purpose of the polarized or grounding-type plug. A polarized plug has two blades with one wider than the other. A grounding type plug has two blades and a third grounding prong. The wide blade or the third prong are provided for your safety. If the provided plug does not fit into your outlet, consult an electrician for replacement of the obsolete outlet.
10. Protect the power cord from being walked on or pinched, particularly at plugs, convenience receptacles, and at the point where they exit from the apparatus.
11. Only use the attachments/accessories specified by the manufacturer.
12. Use only with the cart, stand, tripod, bracket or table specified by the manufacturer or sold with the apparatus. When a cart is used, use caution when moving the cart/appliance combination to avoid injury from tip-over. 
13. Unplug this apparatus during lightning storms or when unused for long periods of time.
14. Refer all servicing to qualified service personnel. Servicing is required when the appliance has been damaged in any way, such as when a power-supply cord or plug is damaged, liquid has been spilled or objects have fallen into apparatus, the apparatus has been exposed to rain or moisture, does not operate normally or has been dropped.
15. If an outside antenna is connected to the television equipment, be sure the antenna system is grounded so as to provide some protection against voltage surges and built up static charges. In the U.S. Selection 810-21 of the National Electrical Code provides information with respect to proper grounding of the mast and supporting structure, grounding of the lead-in wire to an antenna discharge unit, size of grounding conductors, location of antenna discharge unit, connection to grounding electrodes, and requirements for the grounding electrodes.
16. An outside antenna system should not be located in the

vicinity of overhead power lines or other electrical light or power circuits or where it can fall into such power lines or circuits. When installing an outside antenna system, extreme care should be taken to keep from touching such power lines or circuits as contact with them might be fatal.

EXAMPLE OF ANTENNA GROUNDING ACCORDING TO NATIONAL ELECTRICAL CODE, ANSI/NFPA 70

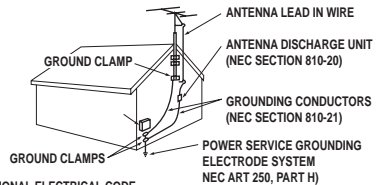

NEC-NATIONAL ELECTRICAL CODE

"Note to CATV system installer:

This reminder is provided to call the CATV system installer's attention to Article 820-40 of the NEC that provides guidelines for proper grounding and, in particular, specifies that the cable ground shall be connected to the grounding system of the building, as close to the point of cable entry as practical.

17. Wall or Ceiling Mounting - The product should be mounted to a wall or ceiling only as recommended by the manufacturer and listed by an independent laboratory (such as UL).
18. Apparatus shall not be exposed to dripping or splashing and no objects filled with liquids, such as vases, shall be placed on the apparatus.
19. When the MAINS plug is used as the disconnect device, the disconnect device shall remain readily operable.
20. Install the LCD TV in a proper position. If not, it may result in a fire hazard.
21. Provide appropriate space on the top, sides and rear of the LCD TV cabinet for allowing air circulation and cooling the LCD TV.
22. Minimum clearance must be maintained. If the LCD TV is to be built into a compartment or similarly enclosed, the minimum distances must be maintained. Do not cover the ventilation slot on the LCD TV. Heat build-up can reduce the service life of your LCD TV, and can also be dangerous.

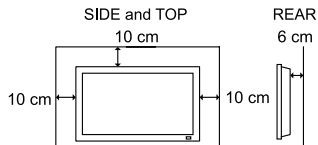

FCC INFORMATION

This equipment has been tested and found to comply with the limits for a Class B digital device, pursuant to Part 15 of the FCC Rules. These limits are designed to provide reasonable protection against harmful interference in a residential installation. This equipment generates, uses and can radiate radio frequency energy and, if not installed and used in accordance with the instructions, may cause harmful interference to radio communications. However, there is no guarantee that interference will not occur in a particular installation. If this equipment does cause harmful interference to radio or television reception, which can be determined by turning the equipment off and on, the user is encouraged to try to correct the interference by one or more of the following measures:

- Reorient or relocate the receiving antenna.
- Increase the separation between the equipment and receiver.
- Connect the equipment into an outlet on a circuit different from that to which the receiver is connected.
- Consult the dealer or an experienced radio/TV technician for help.

CAUTION: FCC Regulations state that improper modifications or unauthorized changes to this unit may void the user's authority to operate the unit.

ENERGY STAR® USER INFORMATION

ENERGY STAR User Information Statement: the factory default settings of this television meet ENERGY STAR requirements. Changing Picture Settings may increase energy consumption, possibly beyond the limits required for ENERGY STAR qualification.

To ensure your television is operating at an optimal energy efficiency, select default picture mode.

TRADEMARKS



Manufactured under license from Dolby Laboratories.

"Dolby" and the double-D symbol are trademarks of Dolby Laboratories.



HDMI, the HDMI logo and High-Definition Multimedia Interface are trademarks or registered trademarks of HDMI Licensing LLC in the United States and other countries.



"As an Energy Star® Partner, Sanyo Electric co., Ltd. has determined that this product meets the Energy Star® guidelines for energy efficiency."



This symbol on the nameplate means the product is Listed by Intertek Testing Services Taiwan Ltd. It is designed and manufactured to meet rigid U.L. safety standards against risk of fire, casualty and electrical hazards.

PROTECTING THE LCD SCREEN

The screen can be damaged if it is not maintained properly. Do not use hard objects such as hard cloth or paper. Do not use excessive pressure when cleaning the screen; excessive pressure can cause permanent discoloration or dark spots.

NEVER spray liquids on the screen.



! HANDLING PRECAUTIONS

- Handle by the cabinet only. Never touch the screen when handling.
- Excessive pressure on the screen can cause permanent discoloration or dark spots.
- Handling damage is **not** covered under warranty.

! CONTAINS MERCURY LAMPS,
DISPOSE OF PROPERLY



CONTENTS

IMPORTANT SAFETY INSTRUCTIONS	2	HELPFUL HINTS - Problems / Solutions	28
FCC INFORMATION	3	SPECIFICATIONS	29
ENERGY STAR® USER INFORMATION	3	CONFIGURATIONS OF VGA	
TRADEMARKS	3	TERMINALS	30
PROTECTING THE LCD SCREEN.....	3	PC / HDMI SIGNAL MODES	30
HANDLING PRECAUTIONS	3		
INSTALLING AND UNINSTALLING			
STAND	5		
INSTALLATION	6		
POSITIONING THE LCD HDTV	6		
WALL MOUNTING (OPTIONAL)	6		
GETTING STARTED	7		
PRECAUTIONS	7		
GETTING STARTED-CONTROLS AND			
JACKS	8		
REMOTE CONTROL OPERATION.....	9		
GETTING STARTED-CONNECTIONS.....	10		
POWER CONNECTION	11		
INITIAL SETUP	11		
INITIAL CHANNEL SCAN	11		
GETTING STARTED-POWER			
CONNECTION/CHANNEL SEARCH.	11		
ADVANCED AV CONNECTIONS	12		
ADVANCED DIGITAL SIGNAL			
CONNECTIONS-HDMI TO HDMI.....	12		
DVI TO HDMI	12		
DIGITAL AUDIO	12		
AUDIO OUT JACKS	12		
PC CONNECTIONS	13		
PC MONITOR OPERATION	13		
SPORTS MODE	14		
ON-SCREEN MENU OPERATION	15		
MENU NAVIGATION MAP	15		
CHANNEL ADJUSTMENT	15		
CHANNEL LIST OPERATION	16		
PARENT ADJUSTMENT	17		
PICTURE/ AUDIO/ ADVANCED			
ADJUSTMENT	19		
PICTURE.....	19		
AUDIO.....	19		
ADVANCED.....	20		
SYSTEM.....	22		
USB PHOTO VIEWER	25		

INSTALLING AND UNINSTALLING STAND

⚠ CAUTION INSTALLING STAND

- When holding (moving or lifting) the LCD Display, hold the display's body. Do not handle the LCD TV by holding the attached accessory parts (speakers), otherwise it may result in damage.
- Before installing, provide a desk (or a part of it) which is strong enough to support the weight of the LCD TV and its stand. The desk must be larger than the LCD Display's screen size. The desk's surface must be flat and covered with soft material (such as a blanket) for protecting the screen surface.
- Before putting the LCD Display on the desk, make sure there is no object on it. Leaving any object under the screen may cause damage on the screen.
- The LCD TV with this stand should be installed on a flat and level place. Do not place it on non flat, unlevel or unstable cart or stand. The display may fall, causing not only serious damage to the products but serious injury to a person.

⚠ SAFETY NOTE

For correct installing, mounting and uninstalling of the LCD TV Stand, it is strongly recommended to use a trained, authorized dealer. Failure to follow correct procedures could result in damage to the equipment or injury to the installer.

Installing Stand (55")

- 1 Place the LCD TV on a flat surface place where maintained with soft materials (such as a blanket) for protecting the display screen.
- 2 Secure the stand to the TV with 4 screws.

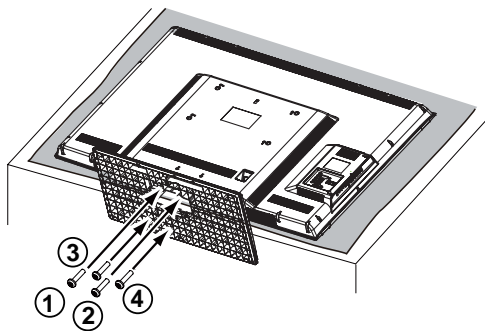

Uninstalling Stand (55")

- 1 Place the LCD TV screen facing down on a flat surface with soft materials (such as a blanket) for protecting the display screen.
- 2 Remove screws in 4 holes with screw driver.

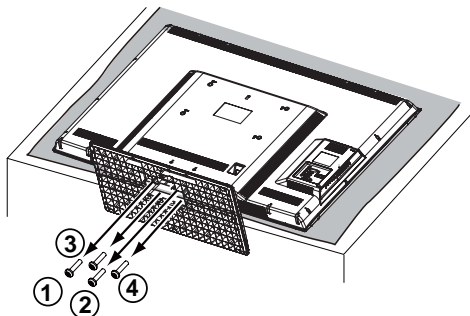

INSTALLATION

POSITIONING THE LCD HDTV



Always use a firm-flat surface when positioning your HDTV. Do not position the unit in a confined area. Allow adequate space for proper ventilation.

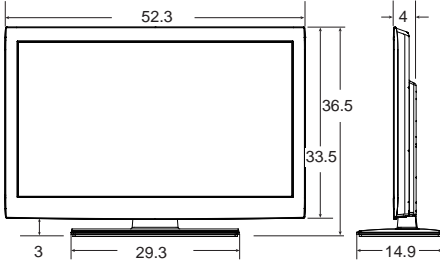

NOTE: All dimensions are in inches.

* Diagonal screen: 54.6 inches

WALL MOUNTING (OPTIONAL)

Use the screws that are threaded into the stand-mounting inserts on the back of your HDTV to secure it to a wall mounting kit.

NOTE: 1. Wall Mounting kit is not supplied.
2. Wall mounting kit shall be able to sustain at least 3 times of set weight.

VESA standard interface:
TV 200 x 400mm

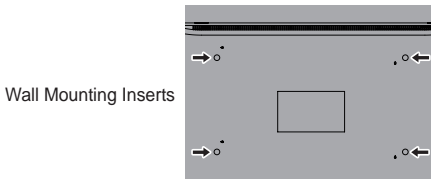

Mounting screws measurements:

55" TV

M8 Diameter, Length - 13mm (min.); 16mm (max.)

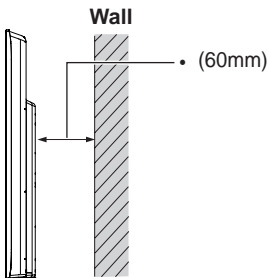

GETTING STARTED

1 Install batteries in the Remote.



PRECAUTIONS

Do not use rechargeables together with dry cells, other types, mixed new and old or batteries with different charge levels.

Do not expose the Remote or batteries to moisture or heat such as sunshine. (the size of battery is AAA).

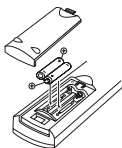

Match the "+" and "-" signs on the batteries with marks inside the Remote Control.

Please recycle used up batteries.

2 Antenna Connection for off-air signals.

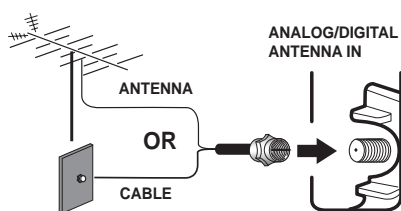

THE TUNER IN THIS HDTV CAN RECEIVE:

a. Digital and Analog off-air signals from an antenna.

OR

b. Analog or Clear QAM cable channels from a direct Cable TV connection.

NOTES:

You must use the on-screen MENU to Search for Clear QAM Cable channels. (see page 11)

For the best picture, connect your Cable box or Satellite receiver to HDMI or component (VIDEO3) jacks.

This HDTV can receive ANY unscrambled RF signal being broadcast.

GETTING STARTED-CONTROLS AND JACKS

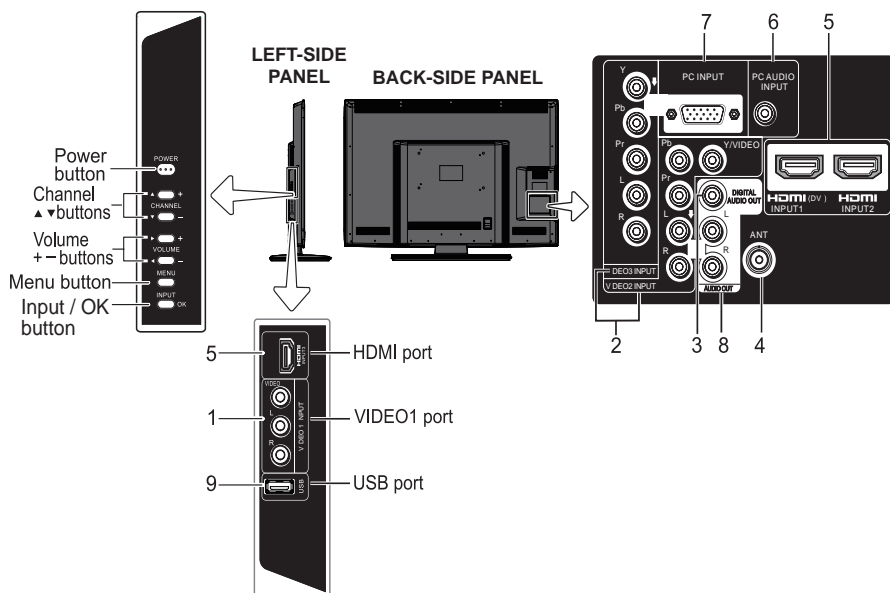

- ① **COMPOSITE VIDEO INPUT VIDEO1, PAGE 10** - Standard (composite) video and audio inputs while using video devices with analog audio and composite video output. Connect digital video equipment to the Video Yellow jack, and matching Audio White (L) and Red (R) jacks.
- ② **COMPONENT VIDEO INPUT VIDEO2 or VIDEO3(YPbPr), PAGE 10** - Connect digital video equipment to the Video Green (Y), Blue (Pb), Red (Pr) jacks, and matching Audio White (L) and Red (R) jacks. These jacks will automatically detect the received signal type.
- ③ **DIGITAL AUDIO OUT (Coaxial), PAGE 12** - Use a Phono-Type (Coaxial) Digital Audio Out Cable to connect Digital Audio Output to an advanced stereo home theater system equipped with Dolby® Digital.
- ④ **ANALOG / DIGITAL ANTENNA INPUT, PAGE 7** - Connect a RF antenna or Analog Cable system to this jack.
- ⑤ **HDMI INPUT (INPUT1, INPUT2 or INPUT3), PAGE 12** - A digital AV interface that accepts uncompressed video signals for the best picture. This HDMI input supports HDCP copy protection and allows transmission of copy-protected digital contents.
- ⑥ **PC AUDIO INPUT, PAGE 12, 20** - This terminal is not only using for PC audio input but also sharing the HDMI audio input for DVI signal connecting.
- ⑦ **PC INPUT (RGB connector of 15 pin D-SUB), PAGE 13** - Connect computer to this terminal. Audio is separated from another Stereo Mini Jack (PC AUDIO INPUT).
- ⑧ **STEREO AUDIO OUT (L/R) JACKS, PAGE 12** - Connect stereo audio equipment to these jacks.
- ⑨ **USB PORT, PAGE 25** - Use for updating the television's firmware and accessing JPEG files.

REMOTE CONTROL OPERATION

- ① **MUTE Button**- Press to mute or restore the sound.
- ② **Numeric Buttons**- Press numeric buttons to select a channel.
Example: Press 6 then OK button to select analog channel A6. Press 6 then 1-- button to select digital channel D6.
- ③ **INPUT Button**- Press to select the source to view: TV, VIDEO1, VIDEO2, VIDEO3, HDMI1, HDMI2, HDMI3, PC or USB Input.
- ④ **SPORTS Button**- Press to choose options Football, Winter Sports, Marine Sports, Indoor Sports, and Off in turn.
- ⑤ **ECO Button** - Press to select Energy saving mode options Off, ECO1, ECO2, and ECO3 in turn.
- ⑥ **Volume Up / Down (VOL+ / -)Buttons**- Press to decrease or increase the audio volume.
- ⑦ **PIX SHAPE Button**- Press to choose options Standard, WaterGlass, Zoom1, Full and Zoom2. Available options depend on the signal and the aspect ratio of the broadcast.
- ⑧ **AUDIO Button**- Press to select the desired audio mode, if available.
- ⑨ **MENU**- Press to display on-screen menu.
CURSOR ▲ (up) ▼ (down) Buttons - Press these buttons to move the cursor up and down.
CURSOR ◀ (left) ▶ (right) Buttons - Press these buttons to move the cursor left and right.
OK Button - Press to select an option from the menu, when required.
EXIT Button - Press to exit from the menu.
- ⑩ **1-- Button** - Press numeric button then press this button to select digital channel.
- ⑪ **GUIDE Button**- Press to show the information window about the current channel on your HDTV screen. (only for digital channels).
- ⑫ **INFO Button**- Press to display channel information banner.
Digital Banner may contain: Channel Number, CC State, Channel Title, Video Resolution, Video Ratio, Signal Strength, Digital Sound information and Program Rating.
Analog Banner may contain: Channel Number, CC State, Channel Title, Video Resolution, Analog Sound information, and Program Rating.
- ⑬ **RECALL Button**- Press to switch to the last channel or input source.
- ⑭ **Channel Up / Down (CH+ / -) Buttons**- Press to switch to the last or next channel.
- ⑮ **RESET Button** - Press this button to display RESET menu. If you execute RESET function, the TV will clear all customized settings.

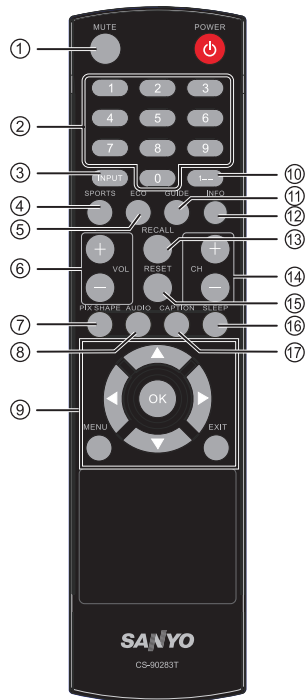

NOTE : The Channel Scan Memory database will be reset to default (all analog channel enabled). You will need to execute Channel Scan after RESET.

- ⑯ **SLEEP Button**- Press this button to set Off Timer function among Off, 30 min, 60 min, 90 min, 120 min, 150 min and 180 min.

NOTE : The Off Timer will be canceled when the TV is turned off or when a power failure occurs.

- ⑰ **CAPTION Button**- Press this button to switch CC mode among "Off", "CC Display" and "Muted-On". Digital Captions can be changed through the SYSTEM CC Style Settings from menu.

GETTING STARTED-CONNECTIONS

- 3** Analog Signal Connections - VIDEO1 or VIDEO2 (Shared with Component-Y).

Connect an analog device such as an Analog Cable Box, Satellite Receiver or VCR.

Composite connectors are included on your HDTV to provide continued compatibility with older analog devices such as a VCR. (Cables are not supplied)

- 1 Connect an AV cable to the VIDEO1 or VIDEO2 jack on the HDTV and to your analog AV equipment as shown. Match the connector colors to jack colors.
- 2 Press the **INPUT** button to step through the signal inputs to select Video1 or Video2.

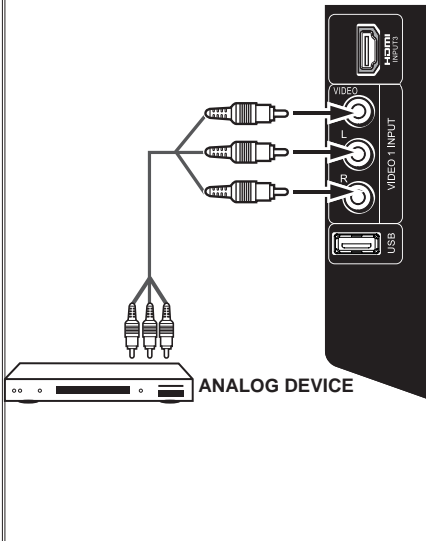

- 4** Component Signal Connections - VIDEO2 or VIDEO3 (YPbPr)

Connect Digital devices such as a HD Cable Box, HD Satellite Receiver, DVD Player, and Game System.

The Component jacks on this HDTV will accept HDTV, EDTV, and SDTV video signals and make a great choice for Component when connecting your compatible external devices.

- 1 Connect a COMPONENT cable to set Green, Blue, and Red video jacks as VIDEO2 or VIDEO3 (YPbPr) on the HDTV and to your digital device as shown. (Cable is not supplied)
- 2 Connect an AUDIO cable to the matching White and Red audio jacks as shown. (Cable is not supplied)

- 3** Press the **INPUT** button to select the input signal as VIDEO2 or VIDEO3 (YPbPr).

NOTES:

- The VIDEO2 with Green video jack, White and Red audio jacks can be used as Composite connectors like VIDEO1 (Shared with Component-Y).
- You may follow the VIDEO2 OPERATION to choose suitable function (Video or YPbPr) for external devices.

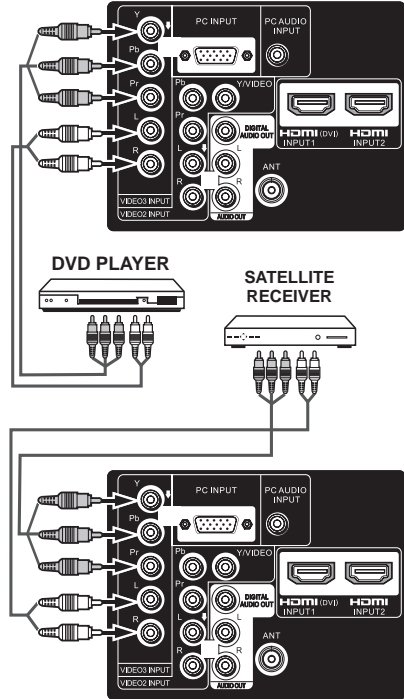

GETTING STARTED-POWER CONNECTION/CHANNEL SEARCH

POWER CONNECTION

5 Plug in AC power cord (120V AC, 60Hz)

6 Press the **POWER** button, (Follow the on-screen instructions).

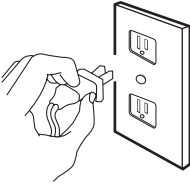

To 120V AC outlet.

INITIAL SETUP

7 Use the **CURSOR** ▲ and ▼ buttons to highlight **Store** or **Home**. Press the **OK** button. TVs will enter **INITIAL CHANNEL SCAN** automatically.

Store : This mode is for the retail display setup.

Home : This mode qualifies for ENERGY STAR.

Please select the proper location for your TV, the display will be adjusted for best result.

Store
 Home

"Store" mode is for the retail display setup,
 "Home" mode qualifies for ENERGY STAR.

▲ ▼ Move OK Enter

INITIAL CHANNEL SCAN

NOTE : Skip the following process if there is no cable or antenna being plugged-in to tuner connector.

8 Use the **CURSOR** ▲ and ▼ buttons to highlight the **Channel Scan**. Press the **OK** button. Choose the **Scan** to start the channel scanning. The scanned channels are stored in Channel List and can be scanned using the **CURSOR** ▲ and ▼ buttons.

CHANNEL

Signal Source	Air
Signal Type	<input checked="" type="checkbox"/> Air All
Channel Scan	<input type="checkbox"/> Cable
Channel List	

▲ ▼ Move OK Enter RETURN Return EXIT Exit

CHANNEL

Signal Source	Air
Signal Type	<input checked="" type="checkbox"/> All All
Channel Scan	<input type="checkbox"/> Analog
Channel List	<input type="checkbox"/> Digital

▲ ▼ Move OK Enter RETURN Return EXIT Exit

CHANNEL

Signal Source	Air
Signal Type	[Cancel]
Channel Scan	<input checked="" type="checkbox"/> [Scan]
Channel List	

▲ ▼ Move OK Enter RETURN Return EXIT Exit

AUTO CHANNEL SEARCH

Analog Channels found : 0
 Digital Channels found : 0

Now Searching Please Wait...

ADVANCED AV CONNECTIONS

ADVANCED DIGITAL SIGNAL CONNECTIONS-HDMI TO HDMI

Connect compatible Digital devices such as a **HD Cable Box, HD Satellite Receiver, DVD Player, and Game System.**

HDMI-High-Definition Multimedia Interface.

This is a digital AV interface that accepts uncompressed video signals for the best picture quality possible. It supports HDCP copy protection and allows transmission of copy-protected digital content. The signal can also include Dolby® Digital or PCM audio when available.

- 1 Connect the HDMI input and your external device with HDMI cable.

NOTE : Press the **INPUT** button to select the input signal as **HDMI1, HDMI2** or **HDMI3**.

DVI TO HDMI

(ONLY HDMI1 IS COMPATIBLE WITH THIS FUNCTION)

- 1 Use an adapter (not supplied) to connect a DVI device to a HDMI1 input jack.

NOTE : HDMI Audio setting is necessary. (refer to page 20)

- 2 Connect the audio out of the device to the PC AUDIO INPUT.

BACK-SIDE VIEW OF HDTV

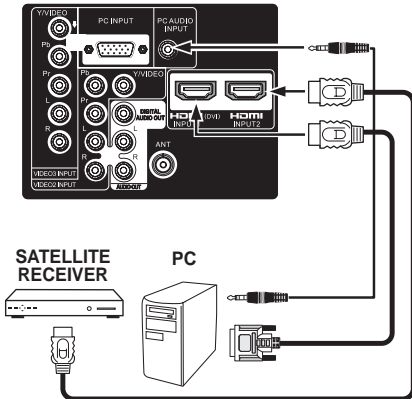

DIGITAL AUDIO

- 1 Connect the Digital Audio output to a multichannel receiver as shown.

NOTE: NOTE: Dolby Digital audio signal is available from the Digital Audio output terminal only when receiving a part of a Digital input on the screen.

BACK-SIDE VIEW OF HDTV

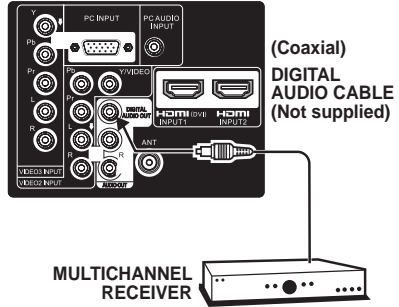

AUDIO OUT JACKS

- 1 Connect the Audio output to a multichannel receiver as shown.

BACK-SIDE VIEW OF HDTV

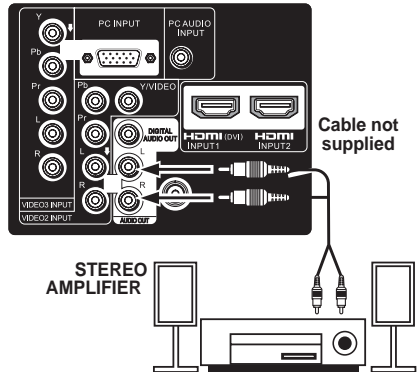

PC CONNECTIONS

! *NOTE: Before connecting any cables, disconnect the AC Power Cords of both the HDTV and Personal Computer from the AC outlets.*

- 1 Connect a RGB cable from the monitor output on your PC to the RGB connector on the HDTV and tighten the screws. (Monitor Cable not supplied).
- 2 Insert one end of a Stereo Mini-Audio cable into the PC Audio Out jack and the other end into the HDTV PC AUDIO INPUT jack. (Stereo Mini-Audio Cable not supplied).

*HINT: Volume can be adjusted both from the PC and the HDTV **VOLUME + / -** buttons.*

- 3 Select Auto Adjustment from the PC Setup Menu.

! *NOTE: Power on the HDTV and any other peripheral equipment before powering on the computer.*

PC MENU NAVIGATION MAP

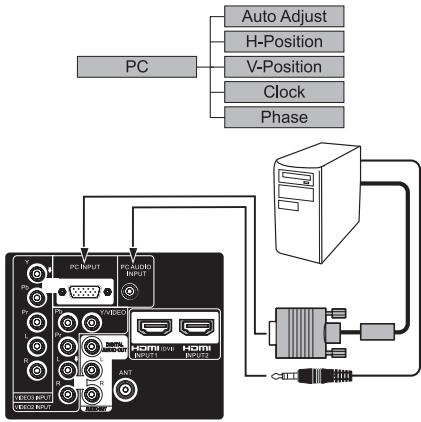

PC MONITOR OPERATION

PC PREPARATION

To avoid a "No Support" condition, preset your PC's output resolution to a XGA value such as 1024 x 768 before you disconnect it from your regular monitor.

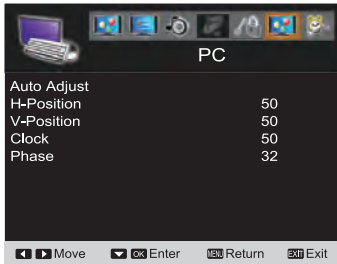

PC MENU- AUTO ADJUSTMENTS OPERATION

- 1 Use the **CURSOR ▲** and **▼** buttons on the remote control to highlight the **Auto Adjust** in the PC menu. Press the **OK** button to start automatically adjust function.

PC MENU- MANUAL ADJUSTMENT OPERATION

The Clock, Phase, Horizontal Position, and Vertical Position are set automatically when Auto Adjustment is completely done.

Clock- Adjust the Dot frequency to match the dot frequency of your computer.

Phase- Adjust the phase when the picture appears flicker or blur.

H-Position- Move the image horizontally.

V-Position- Move the image vertically.

- 1 Use the **CURSOR ▲** and **▼** buttons on the remote control to highlight **H-Position**, **V-Position**, **Clock** or **Phase**. Press the **OK** button.
- 2 Use the **CURSOR ◀** and **▶** buttons to adjust the value of setting. Press the **MENU** button to return.
- 3 Press the **EXIT** button on the remote control to exit the current menu.

PC MENU OPERATING TIPS

The Picture settings in the PC input will not affect other input settings.

SPORTS MODE

By simply pressing the "**SPORTS**" button on the remote control, the TV will automatically optimize both picture and sound settings for the programs shown.

- **Off**
- **Football**
 - For golf, football programs etc.
 - Fresh greenness of the lawn
 - Enfolded cheering voices, ball hitting sounds
- **Winter Sports**
 - For skiing, ice skating programs etc.
 - Details kept white, vivid color of costume
 - Enhanced skiing/skating sounds
- **Marine Sports**
 - For swimming, diving programs etc.
 - Sparkling blue of sea, azure sky
 - Delightful splashing and surf sounds
- **Indoor Sports**
 - For basketball, boxing programs etc.
 - Alive reddish flesh
 - Clear announcements, powerful banging sounds

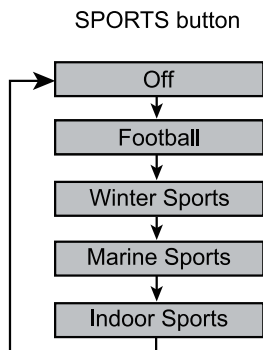

*NOTE : When the "**SPORTS**" button is pushed, an OSD showing the current sports mode will appear on the lower left of the screen. Once the channel or the input source is changed, the sports mode will automatically be set to "**Off**", and the "**Sports Off**" OSD will appear on the upper right of the screen.*

*If the channel or input source is changed under the "**Sports Off**" status, the "**Sports Off**" OSD will not appear on the upper right of the screen.*

ON-SCREEN MENU OPERATION

MENU NAVIGATION MAP

MAIN MENU SUB-MENU OPTIONS

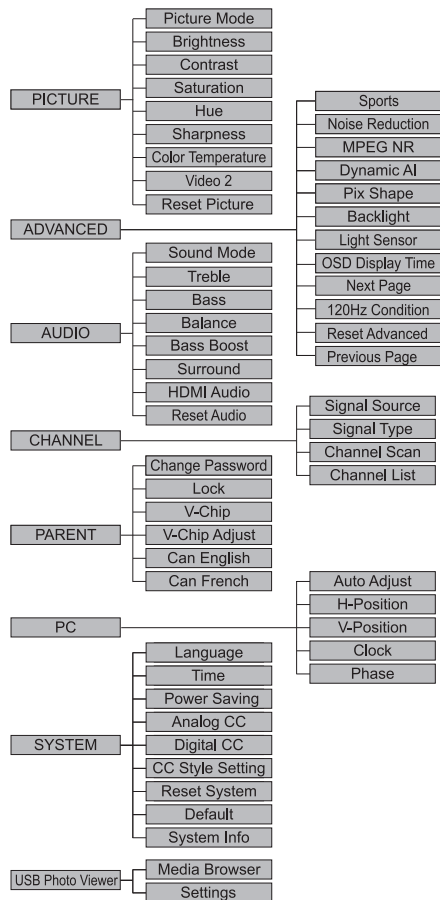

CHANNEL ADJUSTMENT

SIGNAL SOURCE OPERATION

There are two categories:

- Air
- Cable

AIR(Antenna) Search: It will search for analog and digital channels that are broadcasted over-the-air.

Cable Search: It looks for analog cable channels and unscrambled (Clear QAM) digital cable channels.

- 1 Press the **MENU** button on the remote control to display the Main menu. Use the **CURSOR** ◀ and ▶ buttons to highlight **CHANNEL**. Press the **OK** button.
- 2 Highlight **Air** or **Cable**. Press the **OK** button.
- 3 Use the **CURSOR** ▲ and ▼ buttons to highlight **All**. Press the **OK** button. (A red hook will appear beside the selected item).
- 4 Use the **CURSOR** ▲ and ▼ buttons to highlight **Channel Scan**. Press the **OK** button. Choose the **Scan** to start the channel scanning.

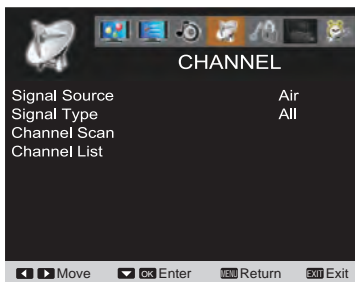

ON-SCREEN MENU OPERATION (CONTINUED)

CHANNEL LIST OPERATION

The **Channel List** is a database of active channels you can scan through using the **CURSOR ▲** and **▼** buttons. Customize it by deleting or adding channels.

- 1 Press the **MENU** button on the remote control to display the Main menu.
- 2 Use the **CURSOR ◀** and **▶** buttons to highlight **CHANNEL** mode. Press the **OK** button.
- 3 Use the **CURSOR ▲** and **▼** buttons to highlight **Channel Scan**. Press the **OK** button. Make the channel scan process completely, then press **OK** or **Menu** to exit.

ADDING CHANNELS TO CHANNEL LIST

- 1 Use the **CURSOR ▲** and **▼** buttons to highlight the **Channel List**. Press the **OK** button.
- 2 Use the **CURSOR ◀** and **▶** buttons to change pages.
- 3 Use the **CURSOR ▲** and **▼** buttons to select and highlight the channel you want to add.
- 4 Press the **VOL+** to add the channel to the Channel List. (A white Y will appear in the squared region. This means the channel is added to the Channel List.)

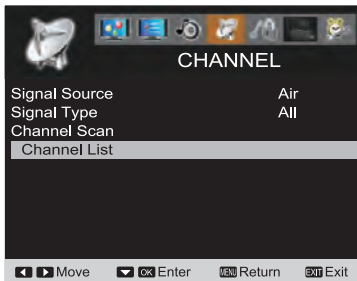

CH	Title	Active
A2		<input type="checkbox"/>
A3		<input checked="" type="checkbox"/>
A4		<input type="checkbox"/>
A5		<input type="checkbox"/>
A6		<input type="checkbox"/>
A7		<input type="checkbox"/>
A8		<input type="checkbox"/>

◀ Move ▶ Enter ⏪ Return ⏩ Exit

DELETING CHANNELS FROM THE CHANNEL LIST

- 1 Use the **CURSOR ▲** and **▼** buttons to highlight the **Channel List**. Press the **OK** button.
- 2 Use the **CURSOR ◀** and **▶** buttons to change pages.
- 3 Use the **CURSOR ▲** and **▼** buttons to select and highlight the channel you want to delete.
- 4 Press the **VOL+** button to delete the channel from the **Channel List**. (A white Y will disappear in the squared region. This means the channel has been deleted from the **Channel List**.)

RENAMING CHANNELS FROM THE CHANNEL LIST

You can rename each channel of the Channel List with following operation:

- 1 Use the **CURSOR ▲** and **▼** buttons to highlight the **Channel List**. Press the **OK** button.
- 2 Use the **CURSOR ◀** and **▶** buttons to show more unshowed channels.
- 3 Use the **CURSOR ▲** and **▼** buttons to select and highlight the channel you want to rename.
- 4 Press the **INFO** button.
- 5 Use **0 ~ 9** buttons to type the channel renaming with each appointed English word, numbers, and symbols by continuously pressing. (HINT: Use **CURSOR ◀** and **▶** buttons to move forward or backward. Use **1--** button to delete.)
- 6 Press the **INFO** button to confirm.

CH	Title	Active
A2	TWM	<input type="checkbox"/>
A3		<input checked="" type="checkbox"/>
A4		<input checked="" type="checkbox"/>
A5		<input checked="" type="checkbox"/>
A6		<input checked="" type="checkbox"/>
A7		<input checked="" type="checkbox"/>
A8		<input checked="" type="checkbox"/>

◀ Move ⏪ Back ⏩ OK

Number Button	Characters	Number Button	Characters
0	0.,?!'-'@/+ =	5	JKLjkl5
1	1	6	MNOmno6
2	ABCabc2	7	PQRSpqrs7
3	DEFdef3	8	TUVtuv8
4	GHIghi4	9	WXYZwxyz9

ON-SCREEN MENU OPERATION (CONTINUED)

PARENT ADJUSTMENT

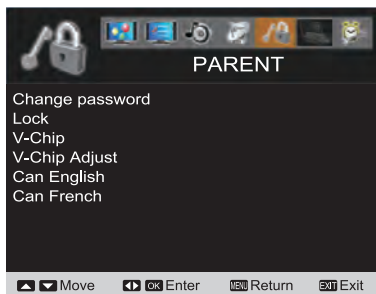

This SANYO television is equipped with an electronic V-Chip to interpret MPAA (Motion Picture Association of America) and TV Parental Guidelines rating codes. When these codes are detected, the HDTV will automatically display or block the program, depending upon choices you make when setting up the PARENT menu.

Use this feature to automatically block programs with content you deem as inappropriate for your children to view.

MORE INFORMATION

Additional information about MPAA and V-Chip rating can be found at:

www.mpa.org and www.v-chip.org, respectively.

PASSWORD SETTING

You will need to set a password when using this TV and entering the PARENT menu for the first time.

Enter this password to access the PARENT menu from the second time.

- 1 Press the **MENU** button and then use the **CURSOR** ◀ and ▶ buttons to highlight **PARENT** menu. Press the **OK** button.
- 2 Use the **0 - 9** buttons to enter "**NEW PIN**" (the new password you want to assign). Press the **OK** button.
- 3 Use the **0 - 9** buttons to enter "**Confirm**" numbers. Press the **OK** button.

NOTE : Please carefully remember new password. If you forget the former password, press 1-- button 4 times to reset password.

Change password OPERATION

- 1 Press the **MENU** button and then use the **CURSOR** ◀ and ▶ buttons to highlight **PARENT** menu. Press the **OK** button.
- 2 Enter password. If the password is correct, it will automatically return to **PARENT** menu. If the password is wrong, you can enter password again or press **MENU** button to return to **PARENT** menu.
- 3 Use the **CURSOR** ▲ and ▼ buttons to highlight **Change Password**. Press the **OK** button.
- 4 Use the **0 - 9** buttons to enter the "**OLD PIN**" (the former password), "**NEW PIN**" (the new password you want to assign), and enter "**Confirm**" numbers in turn. Press the **OK** button.

V-Chip OPERATION

This TV follows the restricted channels broadcast setting within MPAA and TV Rating option in PARENT menu.

- 1 Press the **MENU** button and then use the **CURSOR** ◀ and ▶ buttons to highlight **PARENT**. Press the **OK** button.
- 2 Enter your password. If the password is correct, it will automatically return to the **PARENT** menu. If the password is wrong, you can enter the password again or press **MENU** button to return to the **PARENT** menu.
- 3 Use the **CURSOR** ▲ and ▼ buttons to highlight **V-Chip**. Press the **OK** button.
- 4 Use the **CURSOR** ▲ and ▼ buttons to select **On, Off** or **Reset**. Press the **OK** button.

Lock- Block the broadcast of the current displayed channel directly or current source input.

- 1 Press the **MENU** button and then use the **CURSOR** ◀ and ▶ buttons to highlight **PARENT**. Press the **OK** button.
- 2 Enter your password. If the password is correct, it will automatically return to the **PARENT** menu. If the password is wrong, you can enter the password again or press **MENU** button to return to the **PARENT** menu.
- 3 Use the **CURSOR** ▲ and ▼ buttons to highlight **Lock**. Press the **OK** button.
- 4 Select **On** or **Off**. Press the **OK** button.

Note: Turn on V-Chip function, you can operate V-Chip Adjust.

V-Chip Adjust OPERATION

STANDARD- Decides which kind of classified channel in the Channel List can be viewed.

You can block portions of the TV rating by choosing one or more of the content ratings (D, L, S, V and FV).

By blocking just the L and S content ratings of TV-14, for example, TV-14 rated programs with a D and V content rating could still be viewed.

- 1 Press the **MENU** button and then use the **CURSOR** ◀ and ▶ buttons to highlight **PARENT**. Press the **OK** button.
- 2 Enter your password. If the password is correct, it will automatically return to the **PARENT** menu. If the password is wrong, you can enter the password again or press the **MENU** button to return to the **PARENT** menu.
- 3 Use the **CURSOR** ▲ and ▼ buttons to highlight **V-Chip Adjust** for TV Rating. Press the **OK** button.
- 4 Use the **CURSOR** ▲ and ▼ buttons to select the options you want to adjust and press the **OK** button. (MPAA, Block All, TV-Y, TV-Y7, TV-G, TV-PG, TV-14, and TV-MA.)
- 5 Use the **CURSOR** ▲ and ▼ buttons to select the options you want to adjust and press the **OK** button. Then the option you selected will be locked. (A yellow lock will appear in the squared region).

ON-SCREEN MENU OPERATION (CONTINUED)

MPAA OPERATION

MPAA- Decides which kind of classified movie rating signal can be viewed.

- 1 Press the **MENU** button and then use the **CURSOR** ◀ and ▶ buttons to highlight **PARENT**. Press the **OK** button.
- 2 Enter your password. If the password is correct, it will automatically return to the **PARENT** menu. If the password is wrong, you can enter the password again or press **MENU** button to return to the **PARENT** menu.
- 3 Use the **CURSOR** ▲ and ▼ buttons to highlight **V-Chip Adjust**. Press the **OK** button.
- 4 Use the **CURSOR** ▲ and ▼ buttons to highlight **MPAA** for movie Rating. Press the **OK** button.
- 5 Use the **CURSOR** ▲ and ▼ buttons to select the setting you want to adjust and press the **OK** button. (A yellow lock will appear in the squared region).

CAN ENGLISH OPERATION

- 1 Press the **MENU** button and then use the **CURSOR** ◀ and ▶ buttons to highlight **PARENT**. Press the **OK** button.
- 2 Enter your password. If the password is correct, it will automatically return to **PARENT** menu. If the password is wrong, you can enter password again or press the **MENU** button to return to **PARENT** menu.
- 3 Use the **CURSOR** ▲ and ▼ buttons to highlight **Can English**. Press the **OK** button.
- 4 Use the **CURSOR** ▲ and ▼ buttons to select the setting you want to adjust and press the **OK** button. (A yellow lock will appear in the squared region).

CAN FRENCH OPERATION

- 1 Press the **MENU** button and then use the **CURSOR** ◀ and ▶ buttons to highlight **PARENT**. Press the **OK** button.
- 2 Enter your password. If the password is correct, it will automatically return to **PARENT** menu. If the password is wrong, you can enter password again or press the **MENU** button to return to **PARENT** menu.
- 3 Use the **CURSOR** ▲ and ▼ buttons to highlight **Can French**. Press the **OK** button.
- 4 Use the **CURSOR** ▲ and ▼ buttons to select the setting you want to adjust and press the **OK** button. (A white mark will appear in the squared region.)

*NOTE : Press the **OK** button to make or cancel the selected settings. A lock symbol will appear beside the selected rating option indicating that it is blocked.*

V-Chip Adjust OPERATION

ADVANCED- For V-chip Regional Rating5(RRT5). An advanced V-Chip ratings system for digital channels that are received with an antenna.

When the HDTV detects compatible RRT5 data, it is downloaded and stored in memory and the menu is modified to include advanced adjustment option.

- 1 Press the **MENU** button and then use the **CURSOR** ◀ and ▶ buttons to highlight **PARENT**. Press the **OK** button.
- 2 Enter your password. If the password is correct, it will automatically return to **PARENT** menu. If the password is wrong, you can enter password again or press the **MENU** button to return to the **PARENT** menu.
- 3 Use the **CURSOR** ▲ and ▼ buttons to highlight **V-Chip Adjust**. Press the **OK** button.
- 4 Use the **CURSOR** ▶ button to highlight **ADVANCED**.
- 5 Use the **CURSOR** ▲ and ▼ buttons to select the option you want to adjust. Press the **OK** button. (Dim0,Dim1,Dim2 or Dim3)
- 6 Use the **CURSOR** ▲ and ▼ buttons to select the option you want to adjust. Press the **OK** button. Then the option you selected will be locked. (A yellow lock will appear in the squared region).

NOTE : If current program stream is without RRT5 data, this function will be grayed out. This function is only effective for digital channels including RRT5 data.

PICTURE/ AUDIO/ ADVANCED ADJUSTMENT

PICTURE

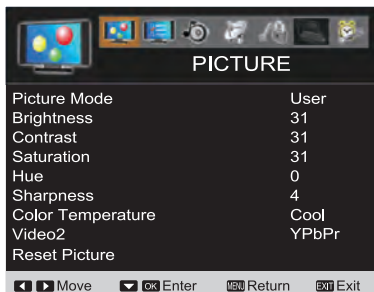

ADJUSTING THE PICTURE LEVELS

PICTURE MODE OPERATION

- 1 Press the **MENU** button on the remote control to display the Main menu.
- 2 Use the **CURSOR** ◀ and ▶ buttons to highlight **PICTURE**. Press the **OK** button.
- 3 Use the **CURSOR** ▲ and ▼ buttons to select the **Picture Mode**. Press the **OK** button.
- 4 Use the **CURSOR** ▲ and ▼ buttons to select the **Cinema, Standard, Vivid** or **User**. Press the **OK** button to add a red hook in the blank space.

BRIGHTNESS/ CONTRAST/ SATURATION/ HUE/ SHARPNESS OPERATION

- 1 Press the **MENU** button on the remote control to display the Main menu.
- 2 Use the **CURSOR** ◀ and ▶ buttons to highlight **PICTURE**. Press the **OK** button.
- 3 Use the **CURSOR** ▲ and ▼ buttons to select the **Brightness, Contrast, Saturation, Hue** or **Sharpness**. Press the **OK** button.
- 4 Use the **CURSOR** ◀ and ▶ buttons to adjust the picture setting.

NOTE:

- These items will be grayed out if you are not select the User mode.
- User mode (Picture Mode) will allow to adjust brightness, contrast, saturation, hue and sharpness function by user.

COLOR TEMPERATURE OPERATION

- 1 Press the **MENU** button to display the Main menu. Press the **OK** button.
- 2 Use the **CURSOR** ◀ and ▶ buttons to highlight **PICTURE**. Press the **OK** button.
- 3 Use the **CURSOR** ▲ and ▼ buttons to highlight **Color Temperature**. Press the **OK** button.
- 4 Use the **CURSOR** ▲ and ▼ buttons to select **Warm, Normal** or **Cool**. Press the **OK** button.

VIDEO2 OPERATION

- 1 Press the **MENU** button to display the Main menu. Press the **OK** button.
- 2 Use the **CURSOR** ◀ and ▶ buttons to highlight **PICTURE**. Press the **OK** button.
- 3 Use the **CURSOR** ▲ and ▼ buttons to highlight **Video2**. Press the **OK** button.
- 4 Use the **CURSOR** ▲ and ▼ buttons to select **YPbPr** or **Video**. Press the **OK** button.

RESET PICTURE OPERATION

Reset Picture- Make the previous adjustment settings under the PICTURE mode recovered from the factory default value.

- 1 Use the **CURSOR** ◀ and ▶ buttons to highlight **PICTURE**. Press the **OK** button.
- 2 Use the **CURSOR** ▲ and ▼ buttons to highlight **Reset Picture**. Press the **OK** button.
- 3 Use the **CURSOR** ▲ and ▼ buttons to select **Reset** or **Cancel**. Press the **OK** button.

NOTE : Press the MENU button to return to the PICTURE mode menu.

AUDIO



SOUND MODE OPERATION

- 1 Press the **MENU** button on the remote control to display the Main menu.
- 2 Use the **CURSOR** ◀ and ▶ buttons to highlight **AUDIO**. Press the **OK** button.
- 3 Use the **CURSOR** ▲ and ▼ buttons to select **Sound Mode**. Press the **OK** button.
- 4 Use the **CURSOR** ◀ and ▶ buttons to adjust the audio setting. (Off/Rock/Pop/Jazz/Vocal/User).

NOTES:

- User mode (Sound Equalizer) will allow to adjust frequency response from 100Hz to 10kHz by user.
- Use the **CURSOR** ▲ and ▼ buttons to select frequency.
- Use the **CURSOR** ◀ and ▶ buttons to adjust the frequency setting.

ADJUSTING THE AUDIO LEVELS

TREBLE/ BASS/ BALANCE OPERATION

- 1 Press the **MENU** button on the remote control to display the Main menu.
- 2 Use the **CURSOR** ◀ and ▶ buttons to highlight **AUDIO**. Press the **OK** button.
- 3 Use the **CURSOR** ▲ and ▼ buttons to select **Treble**, **Bass** or **Balance**. Press the **OK** button.
- 4 Use the **CURSOR** ◀ and ▶ buttons to adjust the audio setting.

BASS BOOST OPERATION

- 1 Press the **MENU** button on the remote control to display the Main menu.
- 2 Use the **CURSOR** ◀ and ▶ buttons to highlight **AUDIO**. Press the **OK** button.
- 3 Use the **CURSOR** ▲ and ▼ buttons to highlight **Bass Boost**. Press the **OK** button.
- 4 Use the **CURSOR** ▲ and ▼ buttons to highlight **Off**, **Low** or **High**. Press the **OK** button.

SURROUND OPERATION

- 1 Press the **MENU** button on the remote control to display the Main menu.
- 2 Use the **CURSOR** ◀ and ▶ buttons to highlight **AUDIO**. Press the **OK** button.
- 3 Use the **CURSOR** ▲ and ▼ buttons to highlight **Surround**. Press the **OK** button.
- 4 Use the **CURSOR** ▲ and ▼ buttons to highlight **Off**, **Low** or **High**. Press the **OK** button.

HDMI AUDIO OPERATION

HDMI AUDIO SETTINGS

HDMI1 includes three categories, Auto, Digital and Analog. (Default setting is Auto)
For the other HDMI port, the HDMI Audio setting will be blocked out and fixed in Digital.

Auto- During this setting, the system will analyze HDMI1 signal type (by info frame) to detect if this input source is pure HDMI or DVI signal. Then it will select the audio input signal from HDMI port or PC AUDIO INPUT port automatically (refer to page 13).

Digital- During this setting, the audio input signal will be fixed to the HDMI1 port.

NOTE : If the HDMI is a DVI signal type, there will be no sound output.

Analog- During this setting, the audio input signal will be fixed to PC AUDIO INPUT port.

NOTE : Even though the HDMI is pure HDMI type, the audio still is selected from the PC AUDIO INPUT port.

- 1 Press the **MENU** button on the remote control to display the Main menu.
- 2 Use the **CURSOR** ◀ and ▶ buttons to highlight **AUDIO**. Press the **OK** button.

- 3 Use the **CURSOR** ▲ and ▼ buttons to highlight **HDMI Audio**. Press the **OK** button.
- 4 Use the **CURSOR** ▲ and ▼ buttons to select **Auto**, **Digital** or **Analog** option. Press the **OK** button. (A red hook will appear in the white blank space).

RESET AUDIO OPERATION

Reset Audio- It can reset previous adjusting settings during the AUDIO mode to the factory default value.

- 1 Use the **CURSOR** ◀ and ▶ buttons to highlight **AUDIO**. Press the **OK** button.
- 2 Use the **CURSOR** ▲ and ▼ buttons to highlight the **Reset Audio**. Press the **OK** button.
- 3 Use the **CURSOR** ▲ and ▼ buttons to select **Reset** or **Cancel**. Press the **OK** button.

*NOTE : Press the **MENU** button to return to the **AUDIO** menu.*

ADVANCED

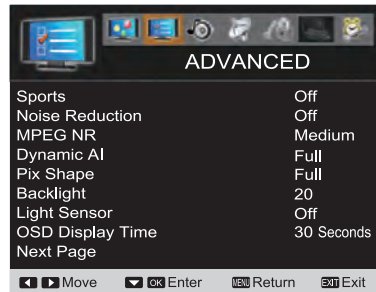

SPORTS OPERATION (See PAGE 14)

- 1 Press the **MENU** button on the remote control to display the Main menu.
- 2 Use the **CURSOR** ◀ and ▶ buttons to highlight **ADVANCED**. Press the **OK** button.
- 3 Use the **CURSOR** ▲ and ▼ buttons to select **Sports**. Press the **OK** button.
- 4 Use the **CURSOR** ▲ and ▼ buttons to select **Off**, **Football**, **Winter Sports**, **Marine Sports** or **Indoor Sports**. Press the **OK** button.

NOISE REDUCTION OPERATION

- 1 Press the **MENU** button on the remote control to display the Main menu.
- 2 Use the **CURSOR** ◀ and ▶ buttons to highlight **ADVANCED**. Press the **OK** button.
- 3 Use the **CURSOR** ▲ and ▼ buttons to select **Noise Reduction**. Press the **OK** button.
- 4 Use the **CURSOR** ▲ and ▼ buttons to select **Off**, **Weak**, **Medium** or **Strong**. Press the **OK** button. DVD player, cable/satellite box and digital camera

signals usually will not need noise reduction.

MPEG NR OPERATION

- 1 Press the **MENU** button on the remote control to display the Main menu.
- 2 Use the **CURSOR** ◀ and ▶ buttons to highlight **ADVANCED**. Press the **OK** button.
- 3 Use the **CURSOR** ▲ and ▼ buttons to select **MPEG NR**. Press the **OK** button.
- 4 Use the **CURSOR** ▲ and ▼ buttons to select **Off**, **Weak**, **Medium** or **Strong**. Press the **OK** button.

DYNAMIC AI OPERATION

- 1 Press the **MENU** button on the remote control to display the Main menu.
- 2 Use the **CURSOR** ◀ and ▶ buttons to highlight **ADVANCED**. Press the **OK** button.
- 3 Use the **CURSOR** ▲ and ▼ buttons to select the **Dynamic AI**. Press the **OK** button.
- 4 Use the **CURSOR** ▲ and ▼ buttons to select **Off**, **Weak**, **Medium** or **Strong**. Press the **OK** button.

NOTE : Please set **PICTURE MODE** to User then can turn on this function **PAGE 19**.

PICTURE (PIX) SHAPE OPERATION

Pix Shape- Divided into three categories. The options during the Pix Shape mode change by the detection of HD, SD or PC inputs.

HD: Full / WaterGlass / Zoom1 / Zoom2

SD: Standard / WaterGlass / Zoom1 / Full / Zoom2

PC: Normal / Full / Dot by Dot

- 1 Press the **MENU** button on the remote control to display the Main menu.
- 2 Use the **CURSOR** ◀ and ▶ buttons to highlight **ADVANCED**. Press the **OK** button.
- 3 Use the **CURSOR** ▲ and ▼ buttons to select **Pix Shape**. Press the **OK** button.
- 4 Use the **CURSOR** ▲ and ▼ buttons to select **Standard**, **WaterGlass**, **Zoom1**, **Full** or **Zoom2**. Press the **OK** button.

NOTE : The remote controls of HD cable and satellite boxes also have similar zoom choices. Try having the TV setting on **FULL** first, and adjust via the cable/satellite box's remote control.

BACKLIGHT OPERATION

- 1 Press the **MENU** button on the remote control to display the Main menu.
- 2 Use the **CURSOR** ◀ and ▶ buttons to highlight **ADVANCED**. Press the **OK** button.
- 3 Use the **CURSOR** ▲ and ▼ buttons to select **Backlight**. Press the **OK** button.
- 4 Use the **CURSOR** ◀ and ▶ buttons to select the desired value between 0 to 50.

NOTE:

- This item will be grayed out if you turn on the Light sensor function.
- Please set Light sensor operation to off then can turn on this function.

LIGHT SENSOR OPERATION

Picture brightness will automatically be boosted or reduced depending on the room brightness.

- 1 Press the **MENU** button on the remote control to display the Main menu.
- 2 Use the **CURSOR** ◀ and ▶ buttons to highlight **ADVANCED**. Press the **OK** button.
- 3 Use the **CURSOR** ▲ and ▼ buttons to select **Light Sensor**. Press the **OK** button.
- 4 Use the **CURSOR** ▲ and ▼ buttons to select **Off**, **Low**, **Middle** or **High**. Press the **OK** button.

NOTE:

- The initial setting of Light sensor in the Home mode is **High**.
- Change this setting to **Middle**, **Low** or **Off** if a picture is too dark in your home.

OSD DISPLAY TIME OPERATION

OSD Display Time

- 1 Press the **MENU** button on the remote control to display the Main menu.
- 2 Use the **CURSOR** ◀ and ▶ buttons to highlight **ADVANCED**. Press the **OK** button.
- 3 Use the **CURSOR** ▲ and ▼ buttons to select the **OSD Display Time** option. Press the **OK** button.
- 4 Use the **CURSOR** ◀ and ▶ buttons to choose from **20 Seconds**, **30 Seconds**, **40 Seconds**, **50 Seconds** or **60 Seconds**. Press the **OK** button.

NEXT PAGE OPERATION

NEXT PAGE - Jump to next page menu.

- 1 Press the **MENU** button on the remote control to display the Main menu.
- 2 Use the **CURSOR** ◀ and ▶ buttons to highlight **ADVANCED**. Press the **OK** button.
- 3 Use the **CURSOR** ▲ and ▼ buttons to select the **Next Page**.
- 4 Press the **OK** button to jump to the next page.

120Hz CONDITION OPERATION

- 1 Press the **MENU** button on the remote control to display the Main menu.
- 2 Use the **CURSOR** ◀ and ▶ buttons to highlight **ADVANCED**. Press the **OK** button.
- 3 Use the **CURSOR** ▲ and ▼ buttons to select the **Next Page**. Press the **OK** button.
- 4 Use the **CURSOR** ▲ and ▼ buttons to select the **120Hz Condition** option.
- 5 Use the **CURSOR** ◀ and ▶ buttons to adjust the **120Hz Condition** setting to **On** or **Off**.

NOTES :

- When you select to PC source or USB mode, the 120Hz CONDITION default setting is set to Off.
- When display happened double shadow or Outer Glow ,please turn off the 120Hz CONDITION.

RESET ADVANCED OPERATION

Reset Advanced- Reset the previous adjustment settings under the ADVANCED mode to the factory default value.

- 1 Use the **CURSOR ◀** and **▶** buttons to highlight **ADVANCED**. Press the **OK** button.
- 2 Use the **CURSOR ▲** and **▼** buttons to highlight **Reset Advanced**. Press the **OK** button.
- 3 Use the **CURSOR ▲** and **▼** buttons to select **Reset** or **Cancel**. Press the **OK** button.

NOTE : Press the **MENU** button to return to the previous **ADVANCED** menu.

PREVIOUS PAGE OPERATION

PREVIOUS PAGE - Return to previous page.

- 1 Press the **MENU** button on the remote control to display the Main menu.
- 2 Use the **CURSOR ◀** and **▶** buttons to highlight **ADVANCED**. Press the **OK** button.
- 3 Use the **CURSOR ▲** and **▼** buttons to select the **Previous Page**.
- 4 Press the **OK** button can return to previous page.

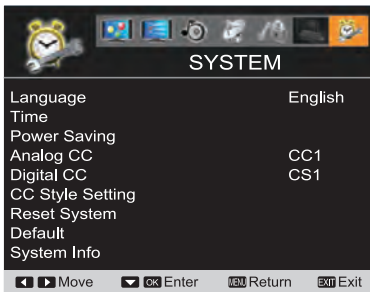
SYSTEM**LANGUAGE OPERATION**

Language- Choose from English, Français, and Español for the on-screen display of menus and messages.

- 1 Press the **MENU** button on the remote control to display the Main menu.
- 2 Use the **CURSOR ◀** and **▶** buttons to highlight **SYSTEM**. Press the **OK** button.
- 3 Use the **CURSOR ▲** and **▼** buttons to highlight **Language** option. Press the **OK** button.
- 4 Use the **CURSOR ▲** and **▼** buttons to select **English, Français** or **Español**. Press the **OK** button. A red hook will appear in the squared and blank region.

TIME OPERATION

Time Zone - Choose from six categories in different location, U.S.A. of Eastern, Central, Mountain, Pacific, Alaska, and Hawaii, for your choice of setting all displayed time zone on all ON- Screen Menu.

- 1 Press the **MENU** button on the remote control to display the Main menu.
- 2 Use the **CURSOR ◀** and **▶** buttons to highlight **SYSTEM**. Press the **OK** button.
- 3 Use the **CURSOR ▲** and **▼** buttons to highlight **Time**. Press the **OK** button.
- 4 Use the **CURSOR ▲** and **▼** buttons to select **Eastern, Central, Mountain, Pacific, Alaska** or **Hawaii**. Press the **OK** button. A red hook will appear in the squared and blank region.

Current Year

- 1 Press the **MENU** button on the remote control to display the Main menu.
- 2 Use the **CURSOR ◀** and **▶** buttons to highlight **SYSTEM**.
- 3 Use the **CURSOR ▲** and **▼** (Down buttons to highlight **Time**. Press the **OK** button.
- 4 Use the **CURSOR ▲** and **▼** buttons to highlight **Current Year**.
- 5 Use the **CURSOR ◀** and **▶** buttons to select year.

Current Date

- 1 Press the **MENU** button on the remote control to display the Main menu.
- 2 Use the **CURSOR ◀** and **▶** buttons to highlight **SYSTEM**.
- 3 Use the **CURSOR ▲** and **▼** buttons to highlight **Time**. Press the **OK** button.
- 4 Use the **CURSOR ▲** and **▼** buttons to highlight **Current Date**.
- 5 Use the **CURSOR ◀** and **▶** buttons to select month number. Press the **OK** button.
- 6 Use the **CURSOR ◀** and **▶** buttons to select date number. Press the **OK** button.

Current Time

- 1 Press the **MENU** button on the remote control to display the Main menu.
- 2 Use the **CURSOR ◀** and **▶** buttons to highlight **SYSTEM**.
- 3 Use the **CURSOR ▲** and **▼** buttons to highlight **Time**. Press the **OK** button.

- 4 Use the **CURSOR ▲** and **▼** buttons to highlight **Current Time**.
- 5 Use the **CURSOR ◀** and **▶** buttons to select hour. Press the **OK** button.
- 6 Use the **CURSOR ◀** and **▶** buttons to select minutes. Press the **OK** button.

On Time Function- turn on Switch on Time function

- 1 Press the **MENU** button on the remote control to display the Main menu.
- 2 Use the **CURSOR ◀** and **▶** buttons to highlight **SYSTEM**.
- 3 Use the **CURSOR ▲** and **▼** buttons to highlight **Time**. Press the **OK** button.
- 4 Use the **CURSOR ▲** and **▼** buttons to highlight **On Time Function**.
- 5 Use the **CURSOR ◀** and **▶** buttons to select **On** or **Off**. Press the **OK** button.

Switch On Time - You can automatic turn on TV at your setting time.

- 1 Press the **MENU** button on the remote control to display the Main menu.
- 2 Use the **CURSOR ◀** and **▶** buttons to highlight **SYSTEM**.
- 3 Use the **CURSOR ▲** and **▼** buttons to highlight **Time**. Press the **OK** button.
- 4 Use the **CURSOR ▲** and **▼** buttons to highlight **Switch On Time**.
- 5 Use the **CURSOR ◀** and **▶** buttons to select hour. Press the **OK** button.
- 6 Use the **CURSOR ◀** and **▶** buttons to select minutes. Press the **OK** button.

POWER SAVING OPERATION

- 1 Press the **MENU** button on the remote control to display the Main menu.
- 2 Use the **CURSOR ◀** and **▶** buttons to highlight **SYSTEM**.
- 3 Use the **CURSOR ▲** and **▼** buttons to highlight **Power Saving**. Press the **OK** button.

Sleep- Choose from Off, 30 min, 60 min, 90 min, 120 min, 150 min, and 180 min for your choice of setting the counting down of time you desire the HDTV to be turned off by itself. The default setting is Off.

- 1 Press the **MENU** button on the remote control to display the Main menu.
- 2 Use the **CURSOR ◀** and **▶** buttons to highlight **SYSTEM**. Press the **OK** button.

- 3 Use the **CURSOR ▲** and **▼** buttons to highlight **Power Saving**. Press the **OK** button.
- 4 Use the **CURSOR ▲** and **▼** buttons to highlight **Sleep**. Press the **OK** button.
- 5 Use the **CURSOR ▲** and **▼** buttons to select **Off**, **30 min**, **60 min**, **90 min**, **120 min**, **150 min** or **180 min**. Press the **OK** button. A red hook will appear in the squared and blank region.

No Signal Standby- Automatic power saving, when no TV signal input display on your panel.

- 1 Press the **MENU** button on the remote control to display the Main menu.
- 2 Use the **CURSOR ◀** and **▶** buttons to highlight **SYSTEM**.
- 3 Use the **CURSOR ▲** and **▼** buttons to highlight **Power Saving**. Press the **OK** button.
- 4 Use the **CURSOR ▲** and **▼** buttons to highlight **No Signal Standby**. Press the **OK** button.
- 5 Use the **CURSOR ▲** and **▼** buttons to select **On** or **Off**. Press the **OK** button.

ANALOG CLOSED-CAPTION OPERATION

Analog CC- Choose from eight types of captions for Analog TV signal for your choice of setting the desired caption type to be displayed with Analog TV signal programs on your HDTV.

- 1 Press the **MENU** button on the remote control to display the Main menu.
- 2 Use the **CURSOR ◀** and **▶** buttons to highlight **SYSTEM**. Press the **OK** button.
- 3 Use the **CURSOR ▲** and **▼** buttons to highlight **Analog CC**. Press the **OK** button.
- 4 Use the **CURSOR ▲** and **▼** buttons to select **CC1**, **CC2**, **CC3**, **CC4**, **TT1**, **TT2**, **TT3** or **TT4**. Press the **OK** button. A red hook will appear in the squared and blank region.

DIGITAL CLOSED-CAPTION OPERATION

Digital CC- Choose from six types of captions for Digital TV signal for your choice of setting the desired caption type to be displayed with Digital TV signal programs on your HDTV.

- 1 Press the **MENU** button on the remote control to display the Main menu.
- 2 Use the **CURSOR ◀** and **▶** buttons to highlight **SYSTEM**. Press the **OK** button.
- 3 Use the **CURSOR ▲** and **▼** buttons to highlight **Digital CC**. Press the **OK** button.
- 4 Use the **CURSOR ▲** and **▼** buttons to select **CS1**, **CS2**, **CS3**, **CS4**, **CS5** or **CS6**. Press the **OK** button. A red hook will appear in the squared and blank region.

CC STYLE SETTING OPERATION

CC Style Setting- Caption is a textual information transmitted along with the picture and sound.

Turning captioning ON causes the HDTV to open these captions (Digital or Analog) and superimpose them on the screen (Local broadcasters decide which caption signals to transmit). Digital Captions can be changed by your choice of the CC Style Setting as shown.

There are several Subcatalogs for each nine categories under the CC Style Setting for your choice of setting the desired caption style superimposed on your HDTV screen.

Category Title	Subcatalog of the Category Title
CC Setting	CC Display / Muted=On / Off
CC Priority	Automatic / Analog CC / Digital CC
Digital CC Preset	Default / Custom
Font Size	Standard / Large / Small
Font Color	White / Red / Green / Blue / Yellow / Magenta / Cyan / Black
Font Style	Style1 / Style2 / Style3 / Style4 / Style5 / Style6 / Style7
Edge Type	None / Raised / Depressed / Outline / L.shadow / R.shadow
Edge Color	White / Red / Green / Blue / Yellow / Magenta / Cyan / Black
Background Color	White / Red / Green / Blue / Yellow / Magenta / Cyan / Black

- 1 Press the **MENU** button on the remote control to display the Main menu.
- 2 Use the **CURSOR** ◀ and ▶ buttons to highlight **SYSTEM**. Press the **OK** button.
- 3 Use the **CURSOR** ▲ and ▼ buttons to highlight **CC Style Setting**. Press the **OK** button.
- 4 Use the **CURSOR** ▲ and ▼ buttons to select **CC Setting**, **CC Priority**, **Digital CC**, **Present**, **Font Size**, **Font Color**, **Font Style**, **Edge Type**, **Edge Color** or **Background Color**. Press the **OK** button.
- 5 Use the **CURSOR** ◀ and ▶ buttons to select the above-mentioned Subcatalog of the Category Title you want to set. Press the **OK** button.

RESET SYSTEM OPERATION

Reset System- Reset the previous adjustment settings under the **SYSTEM** mode to the factory default value.

- 1 Use the **CURSOR** ◀ and ▶ buttons to highlight **SYSTEM**. Press the **OK** button.
- 2 Use the **CURSOR** ▲ and ▼ buttons to highlight **Reset System**. Press the **OK** button.
- 3 Use the **CURSOR** ▲ and ▼ buttons to select **Reset** or **Cancel**. Press the **OK** button.

DEFAULT OPERATION

Default- A function linked to the **RESET** button on the remote control.

Allows you to reset the previous adjustment settings of all ON-Screen Menu Operations to the default value.

NOTE: Be sure you wish to execute this function.

- 1 Use the **CURSOR** ◀ and ▶ buttons to highlight **SYSTEM**. Press the **OK** button.
- 2 Use the **CURSOR** ▲ and ▼ buttons to highlight **Default**. Press the **OK** button.
- 3 Use the **CURSOR** ▲ and ▼ buttons to select **Reset** or **Cancel**. Press the **OK** button.

SYSTEM INFO OPERATION

System Info- Allows your checking the record of the Firmware Code version and release Date kept in your HDTV memory.

- 1 Use the **CURSOR** ◀ and ▶ buttons to highlight **SYSTEM**. Press the **OK** button.
- 2 Use the **CURSOR** ▲ and ▼ buttons to highlight **System Info**. Press the **OK** button.
- 3 Use the **MENU** button to return to **SYSTEM** menu or use the **EXIT** button to close the ON-Screen menu.

USB PHOTO VIEWER

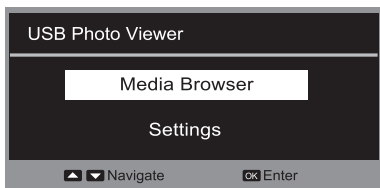

MEDIA BROWSER OPERATION

- 1 Press the **INPUT** button on the remote control and use the **CURSOR** **▲** and **▼** buttons to highlight **USB**. Press the **OK** button.
- 2 Use the **CURSOR** **▲** and **▼** buttons to highlight **Media Browser**. Press the **OK** button.
- 3 Use the **CURSOR** **▲** and **▼** buttons to select JPEG file or JPEG folder. Press the **OK** button.

SINGLE VIEW (Open)

- 1 Use the **CURSOR** **▲** and **▼** buttons to select **Open**. Press the **OK** button.

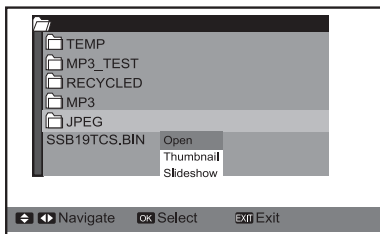

- 2 Use the **CURSOR** **▲** and **▼** buttons to select JPEG file. Press the **OK** button.

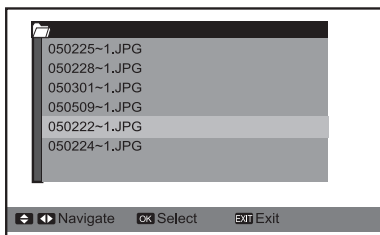

- 3 Use **CURSOR** **▲** and **▼** buttons can rotate the image.

NOTE: **CURSOR** **▲** button can rotate view clockwise.
CURSOR **▼** button can rotate view counterclockwise

- 4 Press **OK** button can zoom in x2 and press **OK** button again can zoom in x4. Press **EXIT** button can minify the image and press exit again can to original size.

Note: **CURSOR** **◀ ▶ ▲ ▼** buttons can scroll over the screen only in Zoom mode(x2,x4)

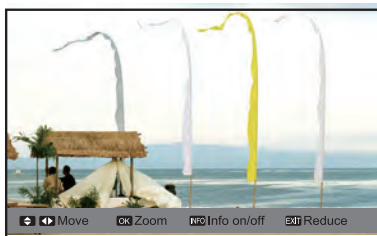

- 5 Use the **EXIT** button to exit this function.

MULTI VIEW (Thumbnail)

- 1 Use the **CURSOR** **▲** and **▼** buttons to select **Thumbnail**. Press the **OK** button.

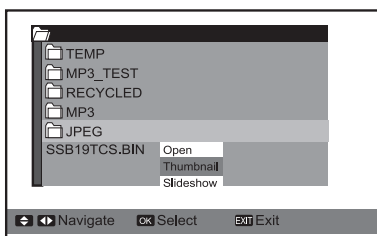

- 2 Press the **OK** button then use the **CURSOR** **◀ ▶ ▲ ▼** buttons to select a JPEG file. Press the **OK** button.



- 3 If the JPEG file more than 15 files. Use the **CURSOR** **◀ ▶ ▲ ▼** buttons to select next page JPEG file.
- 4 Use the **EXIT** button to exit this function.

SLIDESHOW

- 1 Use the **CURSOR** **▲** and **▼** buttons to select **Slideshow**. Press the **OK** button.

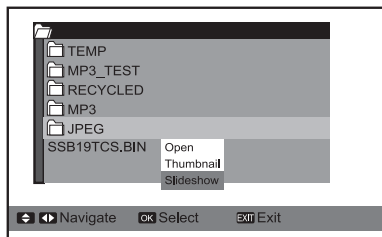

- 2 Use the **EXIT** button to exit this function.

SETTINGS (for Slideshow function) OPERATION

- 1 Use the **CURSOR ▲** and **▼** buttons to highlight **Settings**. Press the **OK** button.
- 2 Use the **CURSOR ▲** and **▼** buttons to highlight **Slideshow Interval**.
Use the **CURSOR ◀** and **▶** buttons to select **3sec**, **5sec** or **10sec**.
- 3 Use the **CURSOR ▲** and **▼** buttons to highlight **Slideshow Effect**.
Use the **CURSOR ◀** and **▶** buttons to select **Off**, **Wipe Right**, **Wipe Down**, **Comb Side**, **Comb UpDown**, **Checker**, **Mosaic**, **Fade**, **Blind Left**, **Blind Down**, **Box In** and **Box Out**.
- 4 Use the **CURSOR ▲** and **▼** buttons to highlight **Slideshow Repeat**.
Use the **CURSOR ◀** and **▶** buttons to select **On** or **Off**.

NOTES:

- The operation bar of JPEG viewer (OSD) will disappear within three seconds.
Press the **INFO** button to display the operation bar again.
- Use the **CURSOR ◀** and **▶** buttons to view Next or Previous picture .
- Use the **INFO** button to close OSD information

HELPFUL HINTS - Problems / Solutions

If you are having problems with your HDTV, check this trouble shooting chart to find one or more possible solutions.

Before returning your HDTV, please visit our website at <http://www.sanyoctv.com> or call us **toll free at 1-800-877-5032 We can Help!**

Problem:	Check these Conditions:	Try these Solutions:	Page No.
No picture, sound (Digital Picture)	<ul style="list-style-type: none"> • Check the antenna / external connections. • There may be a station trouble, no signal broadcast. • MUTE function may be turned ON. 	<ul style="list-style-type: none"> • Adjust antenna. • Try a different channel. • Execute Channel Scan in the CHANNEL menu. (Set Signal Type to All) • Adjust Volume. 	7, 11, 15 - 16
No Caption	<ul style="list-style-type: none"> • Check if station is broadcasting a Closed - Caption signal. • Select another channel. 	<ul style="list-style-type: none"> • Press the CAPTION button to select captioning mode. 	9, 23
Cannot display picture on a full screen		<ul style="list-style-type: none"> • Press the PIX SHAPE button on the remote control to change settings. 	9, 21
Poor Picture/ Sound (watching Analog)	<ul style="list-style-type: none"> • Check if the program is in color. • Check the antenna / external connections. • Color or Tint may be misadjusted. • There may be a station trouble. • MUTE function may be turned ON. 	<ul style="list-style-type: none"> • Try a different channel. • Adjust the antenna. • Execute Reset Picture in the PICTURE menu. • Adjust the Volume and/or Image. 	7,9 19 - 20
"No Signal" message appears on screen	<ul style="list-style-type: none"> • Check the Audio / Video connections. • Check the external equipment connections. • Check the external equipment settings. • Check the antenna connection. 	<ul style="list-style-type: none"> • Press the INPUT button on the remote control. 	7 - 13
Pixilation of Digital image	<ul style="list-style-type: none"> • Press the INFO button and check signal strength. 	<ul style="list-style-type: none"> • Turn antenna, install signal booster. • Install outdoor Digital antenna. 	7, 11
Cannot select or scan some channels	<ul style="list-style-type: none"> • Channel may be removed from memory. • Check antenna connections. • No digital signal being broadcasted. • Weak Signal. 	<ul style="list-style-type: none"> • Selec Channel List to add channels or start channel scan in CHANNEL mode. • Turn antenna, install signal booster. 	7, 11, 15 - 18
No Cable channels above number 13	<ul style="list-style-type: none"> • Check CHANNEL menu, Signal Source item should set to Cable. 	<ul style="list-style-type: none"> • Set Signal Source to Cable, Set Signal Type to All and execute Channel Scan to search for Cable channels in CHANNEL menu. 	11, 15
Remote Control will not operate TV	<ul style="list-style-type: none"> • Check batteries. • Check if the TV is Plugged in. 	<ul style="list-style-type: none"> • Replace batteries. • Aim remote control at front of TV. 	7, 9
Cabinet makes popping sound	<ul style="list-style-type: none"> • This is a normal condition during warm - up and cool down of the plastic cabinet parts. 		
No USB Media message appears on screen	<ul style="list-style-type: none"> • Check the external equipment connections. • Check the external equipment settings. 	<ul style="list-style-type: none"> • Press the INPUT button on the remote control. 	

SPECIFICATIONS

Maximum Visible Range

(H)1209.6 x (V)680.4 mm (54.6" class /138.8 diagonal)

Refresh Rate

120 Hz

Picture Resolution

Full HD 1920X1080

Viewing Angle

Horizontal 178° & Vertical: 178° (Panel tentative)

Brightness

450(Typical) cd/m² (Panel tentative)

Contrast Ratio

5000:1 (Typical) (Panel tentative)

Voltage

120V AC 60Hz

AC Power Consumption (average)

342 Watts

Color System

NTSC3.58

Sound System

M

Channel Coverage

Low band: 54.00 to 144.00MHz Mid band: 145.00 to 424.00MHz High band: 425.00 to 861.25MHz

Sound Output

10W+10W

Dimensions

(Including Stand)

(W)1328 x (H)926 x (D)378 mm

Net Weight

(Including Stand)

31.3 kg

Operating Environment

Operating Temperature: 5°C to 35°C

Operating Humidity: 0 % to 90 %

Storage Temperature: 0°C to 40°C

Storage Humidity: 0% to 90% (non-condensing)

- Specifications are subject to change without notice.
- The On-Screen Menu and figures in this manual may differ slightly from the product.

Input terminals

PC		HDMI/DVI	ANT	Video 1		Video 2/3		USB
VGA	AUDIO JACK			AV	AV Audio	YPbPr	YPbPr Audio	
1	1	3	1	1	1	2	2	1

Output terminals

Digital Audio Output	Audio Output
1	1

CONFIGURATIONS OF VGA TERMINALS

VGA IN (D-SUB) TERMINAL

Terminal : D-SUB15 PIN

Connect video output terminal of LCD TV to this terminal with a VGA Cable (not supplied). When connecting Macintosh computer, the MAC Adapter (not supplied) is required.

Pin Configuration

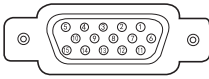

1	Red Input	9	+5V
2	Green Input	10	NC
3	Blue Input	11	Sense 0
4	Reserved	12	DDC_SDA
5	Reserved	13	Horiz. sync.
6	GND	14	Vert. sync.
7	GND	15	DDC_SCL
8	GND		

PC / HDMI SIGNAL MODES

This LCD TV can correspond to the signals below. After connecting with the computer, the TV can automatically recognize the signal from the connected PC (computer) / HDMI.

PC SIGNAL MODE COLUMN (recommended)®

SYSTEM MODE	Resolution	V-Freq.(Hz)	H-Freq.(KHz)	PIXELS CLOCK (MHz)
VGA	640x480	59.94	31.47	25.18
SVGA	800x600	60	37.88	40
XGA	1024x768	60	48.36	65
WXGA	1360x768	60	47.712	85.5
WXGA	1280x768	60	47.78	79.5
SXGA	1280x1024	60	63.981	108

NOTE:

- In principle, the TV can not display signal modes not described in the above column. However, it can sometimes display a signal very similar with one of the modes described.
- It is not the trouble of the TV if interference appears on the picture while switching the signal mode.
- The Dot Clock of the computer's signal must be less than 108 MHz.
- When the input signal from PC is out of the PC signal mode column, above, "No Support" caution message will display. But in some case, the LCD TV will still display the PC signal though the signal mode doesn't exist on the list above. Under this condition, the display position may not correct and the quality may not be admitted also.

When input signal is digital from HDMI terminal, refer to the chart below.

SYSTEM MODE	Resolution	V-Freq.(Hz)	H-Freq.(KHz)	PIXELS CLOCK (MHz)
480I	720(1440)x480	59.94	15.73	27
480P	720x480	59.94	31.47	27
720P/60	1280x720	60	45	74.25
1080I/60	1920x1080	60	33.75	74.25
1080P/24	1920x1080	24	27	74.25
1080P/60	1920x1080	60	67.5	148.5

ONE-YEAR LIMITED PARTS AND LABOR WARRANTY

THIS LIMITED PARTS AND LABOR WARRANTY IS VALID ONLY ON SANYO TELEVISIONS PURCHASED AND USED IN THE UNITED STATES OF AMERICA, CANADA, AND PUERTO RICO, EXCLUDING ALL OTHER U.S. TERRITORIES AND PROTECTORATES. THIS LIMITED WARRANTY APPLIES ONLY TO THE ORIGINAL RETAIL PURCHASER, AND DOES NOT APPLY TO PRODUCTS USED FOR INDUSTRIAL OR COMMERCIAL PURPOSES.

WARRANTY APPLICATION

FOR ONE YEAR from the date of original retail purchase Sanyo Manufacturing Corporation (SMC) warrants this TV to be free from manufacturing defects in materials and workmanship under normal use and conditions for parts and labor.

For the **FIRST 90 DAYS** from the date of original retail purchase, Sanyo Manufacturing Corporation will replace any defective TV via exchange at the retailer. **To ensure proper warranty application, keep the original-dated-sales receipt for evidence of purchase. Return the defective TV to the retailer along with the receipt and the included accessories, such as the remote control. The defective TV will be exchanged for the same model, or a replacement model of equal value, if necessary. Replacement model will be contingent on availability and at the sole discretion of Sanyo Manufacturing Corporation.**

THE FOREGOING WARRANTY IS EXCLUSIVE AND IN LIEU OF ALL OTHER WARRANTIES OF MERCHANTABILITY OR FITNESS FOR A PARTICULAR PURPOSE.

OBLIGATIONS

For one year from the date of purchase, Sanyo Manufacturing Corporation warrants this product to be free from defects in material and workmanship under normal use and conditions. During the first 90 days under this warranty for any manufacturing defect or malfunction Sanyo Manufacturing Corporation will provide a new TV via exchange at the retailer.

HOW TO MAKE A CLAIM UNDER THIS WARRANTY

Please call 1-800-877-5032. Please be prepared to give us the television's model number and serial number when you call. The model number and serial number are **printed on a label attached to** the back of the unit.

For customer assistance, call toll free 1-800-877-5032.

This warranty expresses specific contractual rights; retail purchasers may have additional statutory rights which vary from state to state.

(EFFECTIVE: March 1, 2007)

Your Sanyo HDTV is registered at the time of purchase, please keep sales receipt for future reference.

For your protection in the event of theft or loss of this product, please fill in the information requested below and **KEEP IN A SAFE PLACE FOR YOUR OWN PERSONAL RECORDS.**

Model No. _____

Date of Purchase _____

Serial No. _____

Purchase Price _____

(Located on back of unit)

Where Purchased _____

SANYO

Sanyo Manufacturing Corp.
3333 Sanyo Road, Forrest City, AR 72335

Need help?



www.sanyoctv.com



1-800-877-5032