

# Dishwasher

Instruction for installation and use

**D 41**

 **INDESIT**





# Safety Is a Good Habit to Get Into

## NOTICE

Carefully read the instructions contained in this manual, as they provide important information which is essential to safe and proper installation, use and maintenance of the appliance.



**This appliance complies with the following EEC directives:**

- **73/23/EEC of 19/02/73 (Low Voltage) and subsequent modifications;**

- **89/336/EEC of 03/05/89 (Electromagnetic Compatibility) and subsequent modifications.**

1. Carefully dispose of the packing material.
2. After removing the packing, check to make sure that the appliance is not damaged. If in doubt, contact a qualified professional.
3. The dishwasher must only be used by adults for the washing of household dishes and cooking utensils.
4. Fundamental rules to follow when using the appliance:
  - Never touch the dishwasher when barefoot or with wet hands or feet;
  - We discourage the use of extension cords and multiple sockets;
  - During installation, the power supply cord must not be excessively or dangerously bent or flattened;
  - If the appliance is not operating properly or maintenance

must be performed, disconnect the appliance from the power supply.

**5.** Keep detergents out of the reach of children, who must also be kept away from the dishwasher when it is open.

**6.** This appliance cannot be installed outdoors, not even if the area in which it is installed is covered by a roof; it is also very dangerous to leave it exposed to the rain and elements.

**7.** Do not touch the heating element during or after a wash cycle.

**8.** Do not lean or sit on the door when it is open, as this could overturn the dishwasher.

**9.** If the appliance malfunctions, turn off water supply to the appliance and disconnect the plug from the wall socket. Then, consult the section entitled, "Troubleshooting." If you cannot resolve the problem, contact a service centre.

**10.** Appliances which are no longer being used must be made inoperable by cutting the power supply cord and removing the door lock.

**To maintain the EFFICIENCY and SAFETY of this appliance, we recommend:**

- call only the **Service Centers authorized by the manufacturer**
- always use **original Spare Parts**

## Close-up View (control panel)

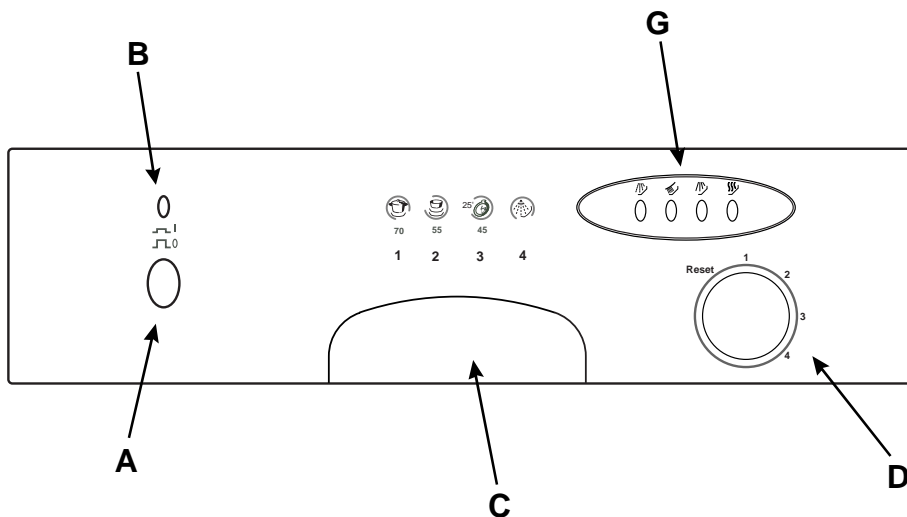

**A** ON - OFF Button

**B** ON - OFF Light

**C** Handle For Opening Door

**D** Knob For Selecting Cycles

**G** Cycle phase indicator lights

## Close-up View (Interior)

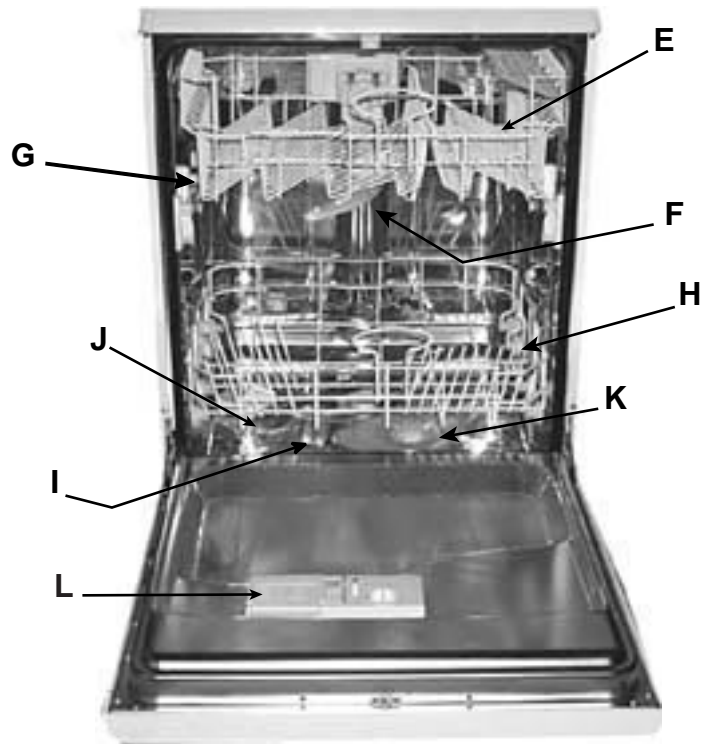

**E** Upper Rack

**F** Top Sprayer Arm

**G** Rack Height Adjustor

**H** Lower Rack

**I** Bottom Sprayer Arm

**J** Salt Container Cap

**K** Washing Filter

**L** Detergent and Rinse Aid Dispenser

### Technical characteristics

Width	cm. 44,5
Depth	cm. 60
Height	cm. 85
Capacity	8 standard place settings
Mains water pressure	20 KPa ÷ 1MPa (0,2 ÷ 10 bar)
Power voltage	See data plate
Total absorber power	See data plate
Fuse	See data plate

# Salt .....

## Salt

The hardness of the water varies from place to place. If hard water is used in the dishwasher, deposits will form on the dishes and utensils.

The appliance is equipped with a special softener that uses a salt specifically designed to eliminate lime and minerals from the water.

### Loading the Salt into the Softener

Always use salt intended for use with dishwashers. The salt container is located beneath the lower rack and should be filled as follows:



1. Remove the lower rack and then unscrew and remove the cap from the salt container;
2. If you are filling the container for the first time, fill it with water;
3. Place the end of the funnel (supplied) into the hole and introduce about 2 kg of salt. It is normal for a small amount of water to come out of the salt container.
4. Carefully screw the cap back on.

**The salt container should be filled after about every 30 wash cycles.**

**Warning:** To prevent rust from forming, we advise you to load the salt **before** starting a wash cycle.

## Adjusting Salt Consumption

The dishwasher is designed to allow for adjusting the amount of salt consumed based on the hardness of the water used. This is intended to optimize and customize the level of salt consumption so that it remains at a minimum.

Your Local Water Board can supply the degree of hardness of the water in your area.

To adjust salt consumption, proceed as follows:

- 1) Unscrew the cap from the salt container.
- 2) There is a ring on the container with an arrow on it (see figure to the side), if necessary, rotate the ring in the anti-clockwise direction from the "-" setting towards the "+" sign, based on the hardness of the water being used.

It is recommended that adjustments be made in accordance with the following schema:

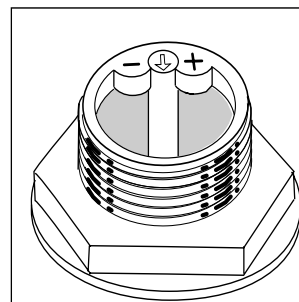

Water Hardness					
Clarke degrees	°fH	mmol/l	Selector position	Salt consumption (grams/cycle)	Autonomy (cycles\2-kg)
0 - 14	0 - 17	0 - 1,7	/	0	/
14 - 36	18 - 44	1,8 - 4,4	"-"	20	60
36 - 71	45 - 89	4,5 - 8,9	MED	40	40
>71	> 89	> 8,9	"+"	60	25

## Detergent and Rinse Aid ....

### Detergent

Detergent specifically intended for use with dishwashers must be used. The dispenser must be refilled before the start of each wash cycle following the instructions provided in the "Wash Cycle Table." The detergent dispenser is located on the inside panel of the door.

### Loading the detergent

To open lid "A", press button "B". The cleaning detergent should be introduced into the two containers "C" and "D" up to the rim.

After pouring in the detergent, replace the lid, pressing down until it clicks.

Dishwasher detergent in tablets is now available on the market, in which case you should place one tablet into container "D" and replace the lid.

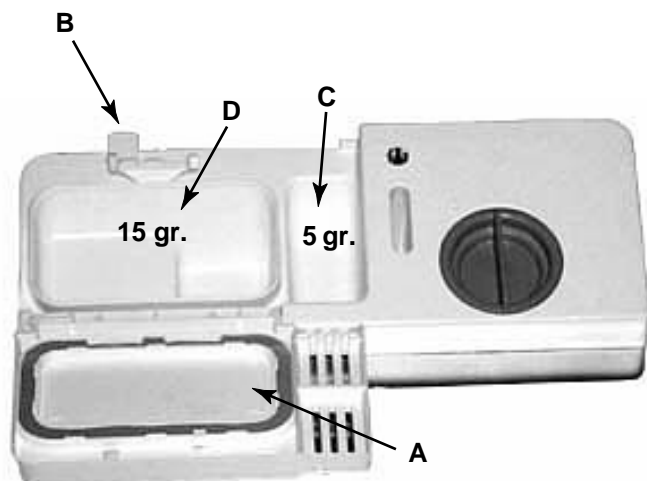

**Notice:** To facilitate closing the cover, remove any excess detergent on the edges of the dispenser.

### Warning

Three-in-one dishwasher tablets are now available on the market, and combine the detergent, salt and rinse aid all in one. If the water in your area is hard or very hard, we still recommend you pour extra salt into the relevant dispenser to prevent the formation of white streaks on your dishes or on the appliance interior.

In any case, please read the manufacturer's instructions provided on the packet.

### Rinse Aid

This product makes dishes sparkle more as it improves their drying. The rinse aid container is situated on the inside of the appliance door; you should refill it when you see the container is empty by means of indicator "D".

(If your dishwasher is fitted with a "low rinse aid" indicator light, fill the container up when the indicator light flashes or lights up).

### Loading the Rinse Aid

To open the dispenser, turn the "C" cap in the anti-clockwise direction and then pour in the rinse aid, making sure not to overfill. The amount of rinse aid used for each cycle can be regulated by turning the "F" dose adjuster, located beneath the "C" cap, with a screwdriver. There are 6 different settings; the normal dosage setting is 2.

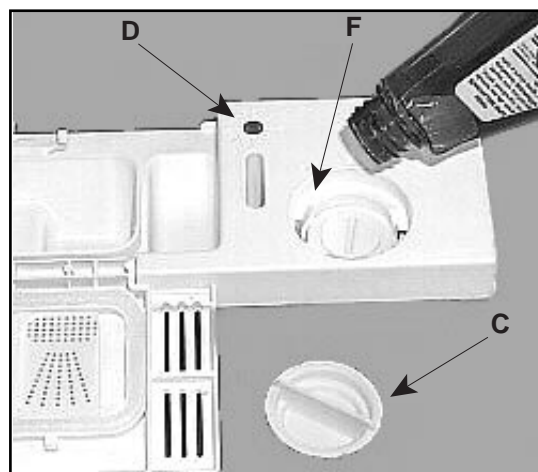

### Important:

*Proper dosage of the rinse aid improves drying.*

*If drops of water remain on the dishes or spotting occurs, the dosage adjuster should be turned to a higher setting. If the dishes have white streaks, turn the dosage adjuster to a lower setting.*

# Loading the Dishwasher

Before placing the dishes in the dishwasher, remove the larger food particles to prevent the filter from becoming clogged, which results in reduced performance.

If the pots and pans have baked-on food that is extremely hard to remove, we recommend that they be allowed to soak before they are washed. This will eliminate the need for extra wash cycles.

Pull out the racks to facilitate loading the dishwasher.

## How to Use the Lower Rack

We recommend that you place the most difficult to clean items on the bottom rack: pots, pans, lids, serving dishes and bowls, as shown in the figure to the right.

It is preferable to place serving dishes and lids on the sides of the racks in order to avoid blocking the rotation of the top spray arm.

- Pots, serving bowls, etc. must always be placed top down.

- Deep pots should be slanted to allow the water to flow out.

- Silverware should be placed in the silverware basket with the handles at the bottom; If the rack has side baskets, the spoons should be loaded individually into the appropriate slots (see fig. **A**)

Especially long utensils should be placed in the horizontal position at the front of the upper rack.

## How to Use the Upper Rack

The upper rack is designed to hold more delicate and lighter dishware, such as glasses, coffee and tea cups and saucers, as well as plates, small bowls and shallow pans (as long as they are not too dirty).

- Position the dishes and cookware so that they do not get moved by the spray of water.

## How to adjust the Upper rack ...

The top rack can be adjusted using the two rack heights (top and bottom). To adjust the rack, open up the tabs that lock the guides and pull out the rack. Arrange the rack with the back wheels in either the top or bottom position and then insert it along the guides until the front wheels are on as well. Close the tabs to lock the rack in place (see Fig. **F**)

## Load examples

Top Rack



Top Rack

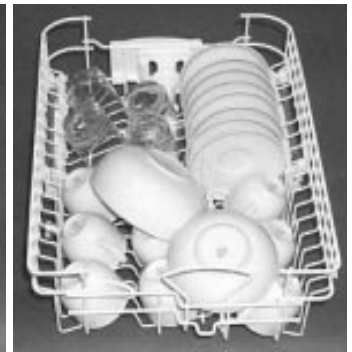

Lower Rack



Lower Rack



Fig. A

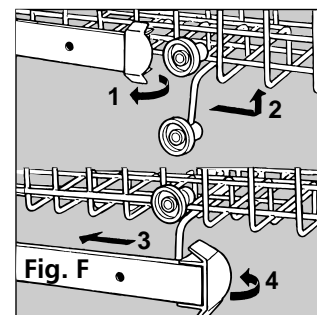

Fig. F

# Turning on the Appliance

## Starting a wash cycle....

After having completed all of the installation steps in the preceding paragraphs, turn on the water to the unit and press the ON-OFF button (A) located on the control panel. The "B" indicator light will come on. At this point, the appliance is on and ready to be programmed.

## Starting and selecting the cycle.

Turn the cycle selector knob "D" until the reference notch on the knob corresponds with the number or the symbol for the cycle you wish to set (have a look at the wash cycle table on page 7).

After a few seconds, you will hear a short beep and the indicator light "G" comes on, indicating that the wash cycle has begun and it is not advisable to make any changes at this point.

## Cycle phase indicator lights

The dishwasher is provided with 4 indicator lights "G" which come on in sequence as the appliance is performing that specific phase of the wash cycle.

These phases are, from left to right:



pre-wash,



wash,



rinses,



drying

## Cancelling or modifying a wash cycle in progress.....

*Premise:* You can cancel the wash cycle in progress, if it has only just started.

To modify a wash cycle in progress, turn the knob anti-clockwise and set it to Reset, after a few seconds you will hear 4 beeps and indicator light "G" will go out: this means all the settings have been cancelled. You are now free to re-set the correct wash cycle.

## If you forget to load some of the dishes...

The wash cycle can be interrupted by pressing the ON-OFF. You can then load additional dishes and turn the appliance back on. The cycle will start where it left off.

## At the end of the wash cycle....

The end of the wash cycle is signalled by 2 short beeps and a flashing drying phase indicator light "G". Set the knob to the **Reset** position to clear all settings.

Turn the appliance off by pressing button "A", thus cutting off the electricity supply.

Turn off the water tap.

Wait a few minutes before unloading the dishes: they are very hot! If you wait a little while, they dry better thanks to the steam.

Empty the lower rack first.

*Make sure the wash cycle has ended before removing the dishes!*

## There's been a power failure? Have you opened the dishwasher door?

The wash cycle stops and then restarts when the electricity comes back on or when you close the door.

## Warning

*If opening the door soon after the end of the programme, or during it, stand away from the Dishwasher, to avoid possible injury from hot steam.*



# Wash Cycle Table

Cycle	Cycle selection instructions	Cycle description	Detergent for pre-wash + wash	Rinse Aid
<b>1) Heavy Duty</b>	Very dirty dishes and pans (not to be used for delicate items).	Pre-wash with cold water Pre-wash with hot water at 45°C Extended wash at 70°C. Cold rinse Rinse with hot water at 70°C. Drying.	<b>5+15 gr.</b>	<b>*</b>
<b>2) Normal wash</b>	Normally dirty pans and dishes. Standard daily cycle.	2 pre-washes with cold water. Extended wash at 55°C. Rinse with hot water at 70°C. Drying.	<b>5+15 gr.</b>	<b>*</b>
<b>3) Rapid 25'</b>	Economic and fast cycle to be used for slightly dirty dishes. Run cycle immediately after use. No drying.	Short wash at 45°C. Cold rinse.	<b>15 gr.</b>	
<b>4) Soak</b>	Preliminary wash cycle for dishes and pans awaiting completion of the load with the dishes from the next meal.	Short cold wash to prevent food from drying onto the dishes.		

## Energy Saving Tips

- It is important to try and run the dishwasher when it is fully loaded in order to save on energy. In order to prevent odors from forming and food from caking onto the dishes, you can run the hold cycle.

- Choose the right wash cycle: the choice of cycle depends on the type of dishware, cookware and utensils being washed and how dirty they are.

- Use the right amount of detergent: if you use too much detergent, the result will not be cleaner dishes, but, rather, a greater negative impact on the environment.

- There is no utility in rinsing dishes, cookware and utensils before placing them in the dishwasher.

## How to Keep Your Dishwasher in Shape

### **After Every Wash**

After every wash, turn off the water supply to the appliance and leave the door slightly ajar so that moisture and odors are not trapped inside.

### **Remove the Plug**

Before cleaning or performing maintenance, always remove the plug from the socket. Do not run risks.

### **No Solvents or Abrasive Cleaning Products**

To clean the exterior and rubber parts of the dishwasher, do not use solvents or abrasive cleaning products. Rather, use only a cloth and warm soapy water.

To remove spots or stains from the surface of the interior, use a cloth dampened with water and a little white vinegar, or a cleaning product made specifically for dishwashers.

### **When You Go on Holiday**

When you go on holiday, it is recommended that you run a wash cycle with the dishwasher empty and then remove the plug from the socket, turn off the water supply and leave the door of the appliance slightly ajar. This will help the seals last longer and prevent odors from forming within the appliance.

### **Moving the Appliance**

If the appliance must be moved, try to keep it in the vertical position. If absolutely necessary, it can be positioned on its back.

### **Seals**

One of the factors that cause odors to form in the dishwasher is food that remains trapped in the seals. Periodic cleaning with a damp sponge will prevent this from occurring.

# Cleaning and Special Maintenance

## The filter assembly

If you want consistent good results from your dishwasher, you need to clean the filter assembly; this way the food particles are removed from the wash water, allowing it to be recirculated during the cycle, filtered perfectly. For this reason, it is a good idea to remove the larger food particles trapped inside

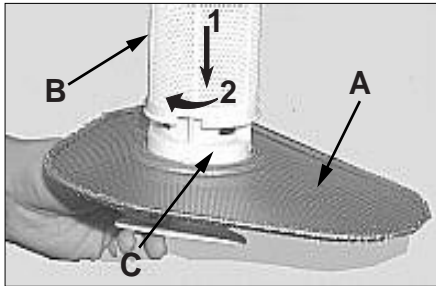

the cup "C" and semi-circular filter "A" after each wash. All you need to do is rinse them under running water; to remove these, pull the cup handle upwards. The entire filter assembly, comprising a semi-circular filter "A", a cup "C", and a cylindrical filter "B" should be cleaned thoroughly once a month. Rotate filter "B" anticlockwise to remove it. For cleaning, use a non metallic brush.

Reassemble the three parts as shown in the figures and reinsert the whole assembly into the dishwasher, positioning it into its housing and pressing downwards.

The dishwasher is not to be used without filters. Improper replacement of the filters may reduce the efficiency of the wash and even damage your dishwasher.

## Cleaning the Sprayer Arms

It may happen that food particles become encrusted on the sprayer arms and block the holes. Check the sprayer arms periodically and clean them when needed (see "Close-up View [interior]", letters F-I).



## Cleaning the Water Inlet Filter

Periodically clean the water inlet filter (see figure 2 under "Installation") located on the outlet of the water supply tap. After turning off the water tap, unscrew the end of the water supply hose, remove the filter and clean it carefully under running water. Then, return the filter to its place and tighten the water supply hose back into position.

# Troubleshooting

It may occur that the dishwasher does not function or does not function properly. Before calling for assistance, let us see what can be done first: have you forgot to press one of the buttons or to perform an essential operation?

## The Dishwasher Does Not Start

Have you checked whether:

- the plug is pushed into the socket correctly;
- the power is on in the house;
- the door is closed properly;
- the ON-OFF switch is on "ON";
- the water supply is turned on.

## The Dishwasher Does Not Load Water

Have you checked whether:

- the water is turned on and the hose is connected properly;
- the water supply to the house is on and has sufficient pressure;
- the water supply hose is crimped or bent;
- the filter for the water supply hose is clogged.

## The Dishes Are Not Clean

Have you put the right amount of detergent into the dispenser?

Is the wash cycle suitable for the dishes you have placed inside the appliance?

Are the filter and microfilter clean?

Can the sprayer arms turn freely?

## The Dishwasher Does Not Drain

Have you checked whether:

- the drain hose is crimped or bent.

## Lime Deposits or a White Film Form on the Dishes

Have you checked whether:

- the lid to the salt container is closed properly;
- the rinse aid dosage is correct.

## Error messages

Your dishwasher is equipped with a safety system which is able to detect any operating anomalies. These anomalies are reported by one or two cycle phase indicator lights "G" flashing rapidly. Take a note of which lights are flashing, turn the appliance off and call for technical assistance.

## Tap off alarm

If you have forgotten to turn the water tap on, your appliance will remind you of this by sounding a few short beeps for a few minutes. Turn the tap on and your appliance will start up again after a few minutes. Were you to be absent when these beeps are sounded, the appliance will be blocked automatically and cycle phase 2 and 3 indicator lights (wash and rinses) will flash rapidly. Turn the appliance off at the ON-OFF button, turn on the water tap and wait approximately 20 seconds before turning the appliance back on, now the program will start.

If, despite all these checks, the dishwasher still does not function and/or the problem persists, contact the nearest authorised service centre and provide them with the following information:

- the nature of the problem;
- the model type number (Mod. ...) and the serial number (S/N ...), which are indicated on the plate located on the side of the inner part of the door.

**Never call on unauthorised technicians and refuse to allow parts to be installed that are not original spare parts.**

# Installation

## Positioning the Appliance

Position the appliance in the desired location. The back should rest against the wall behind it, and the sides, along the adjacent cabinets or wall. The dishwasher is equipped with water supply and drain hoses that can be positioned to the right or the left to facilitate proper installation.

## Levelling the Appliance

Once the appliance is positioned, adjust the feet (screwing them in or out) to adjust the height of the dishwasher, making it level. In any case, the appliance should not be inclined more than 2°.

If the appliance is level, it will help ensure proper performance.

*This dishwasher model can be built-in under the one worktop, and it therefore comes provided with an instructions sheet.*

## Cold Water Connection

Connect the cold water supply hose to a threaded 3/4 (gas) connector, inserting the small filter supplied with the dishwasher and making sure that it is fastened tightly in place (see figure 2).

If the water pipes are new or have not been used for an extended period of time, let the water run to make sure that the water is clear and free of impurities. If this precaution is not taken, there is a risk that the water inlet can get blocked and damage the appliance.

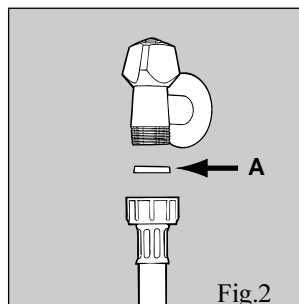

## Hot Water Connection

The water supply to the appliance can also be connected to the house's hot water line (centralised system, heating system), as long as it does not exceed a temperature of 60° C.

In this case, the wash cycle time will be shortened by about 15 minutes and the wash efficiency slightly reduced.

The connection must be made to the hot water line following the same procedures as those for the connection to the cold water line.

## Drain Hose Connection

Insert the drain hose into a drain pipe with a minimum diameter of 4 cm., or let it run into the sink, making sure to avoid bending or crimping it. Use the special plastic support that comes with the appliance (see figure to the right). The free end of the hose must be at a height between 40 and 100 cm. and must not be immersed in water.

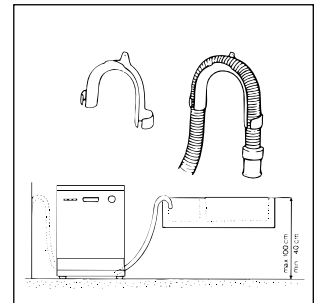

**Attention:** *The special plastic hose support must be solidly fastened to the wall to prevent the drain hose from moving and allowing water to spill outside the drain.*

## Electrical Connection

After making sure that the voltage and frequency values for the current in the home correspond to those on the rating plate (located on the stainless steel inner door of the appliance) and that the electrical system is sized for the maximum voltage on the rating plate, insert the plug into an electrical socket which is earthed properly (the earthing of the appliance is a safety requirement mandated by law). If the electrical socket to which the appliance must be connected is not appropriate for the plug, replace the plug, rather than using adaptors or the like as they could cause overheating and burns.

*Should the electricity supply cable be damaged, we recommend that you only contact authorised Technical Service Centres for the replacement.*

# Electrical Connection

## Electrical Connection

If your appliance is supplied with a 13 amp. fused plug it can be plugged into a 13 amp socket for immediate use. Before using the appliance please read the instruction below.

**WARNING: THIS APPLIANCE MUST BE EARTHED. THE FOLLOWING OPERATIONS SHOULD BE CARRIED OUT BY A QUALIFIED ELECTRICIAN.**

### Replacing the fuse:

When replacing a faulty fuse, a 13 amp ASTA approved fuse to BS 1362 should always be used, and the fuse cover re-fitted. If the fuse cover is lost, the plug must not be used until a replacement is obtained.

### Replacement fuse covers:

If a replacement fuse cover is fitted, it must be of the correct colours as indicated by the coloured marking or the colour that is embossed in words on the base of the plug. Replacements can be obtained directly from your nearest Service Depot.

### Removing the plug:

If your appliance has a non-rewireable moulded plug and you should wish to remove it to re-route the mains cable through partitions, units etc., please ensure that either:

- the plug is replaced by a fused 13 amp re-wireable plug bearing the BSI mark of approval
- or:
- the mains cable is wired directly into a 13 amp cable outlet, controlled by a switch, (in compliance with BS 5733) which is accessible without moving the appliance.

### Disposing of the plug:

Ensure that before disposing of the plug itself, you make the pins unusable so that it cannot be accidentally inserted into a socket.

### Instruction for connecting cable to an alternative plug:

Important: the wires in the mains lead are coloured in accordance with the following code:

Green & Yellow	- <b>Earth</b>
Blue	- <b>Neutral</b>
Brown	- <b>Live</b>

### CAUTION:

The dishwasher plug must be accessible even when the appliance is installed as a built-in unit so that maintenance can be done safely.

As the colours of the wires in the mains lead may not correspond with the coloured markings identifying the terminal in your plug, proceed as follows: connect Green & Yellow wire to terminal marked "E" or  $\perp$  coloured Green or Green & Yellow.

Connect Brown wire to terminal marked "L" or coloured Red.

Connect Blue wire to terminal marked "N" or coloured Black.

If a 13 amp plug (BS 1363) is used it must be fitted with a 13 amp fuse. A 15 amp plug must be protected by a 15 amp fuse, either in the plug or adaptor or at the distribution board.

If you are in any doubt about the electrical supply to your machine, consult a qualified electrician before use.

### How to connect an alternative plug:

The wires in this mains lead are coloured in accordance with the following code:

BLUE	"NEUTRAL" ("N")
BROWN	"LIVE" ("L")
GREEN AND YELLOW	"EARTH" ("E")

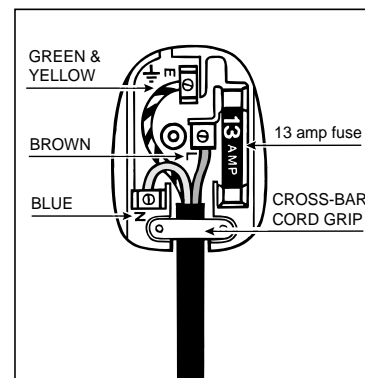

### Disposing of the appliance:

When disposing of the appliance please remove the plug by cutting the mains cable as close as possible to the plug body and dispose of it as described above.





# Merloni Elettrodomestici

Viale Aristide Merloni 47

60044 Fabriano

Italy

Tel +39 0732 6611

Fax +39 0732 662501

[www.merloni.com](http://www.merloni.com)