

jWIN

PORTABLE DVD PLAYER WITH 9" ACTIVE MATRIX TFT LCD



Instruction Manual

JD-VD762

Please read this manual carefully before operating and save it for future reference.

Have a question? Please visit <http://www.jWIN.com>

USER SAFETY GIUDE

IMPORTANT SAFETY INSTRUCTIONS

WARNING: To prevent fire or shock hazard, do not expose this appliance to rain or moisture.



CAUTION
RISK OF ELECTRIC SHOCK
DO NOT OPEN



These markings are located on the bottom, side or back of the unit.

CAUTION: To prevent the risk of electric shock, do not remove cover (or back). Non- user-serviceable parts inside. Refer servicing to a service professional.

- The lightning flash with an arrowhead symbol, within an equilateral triangle, is intended to alert the user to the presence of un-insulated "dangerous voltage" within the product's enclosure that may be of sufficient magnitude to constitute a risk of electric shock to a person.
- The exclamation point within an equilateral triangle is intended to alert the user to the presence of important operating, maintenance and servicing instructions in the literature accompanying the appliance.

Dripping warning: "This product shall not be exposed to any dripping or splashing, and no objects filled with liquids, such as vases, shall be placed on or near the product."

Ventilation warning: "The normal ventilation of the product shall not be impeded for intended use." (Minimum distances must be kept around the apparatus for sufficient ventilation, especially while use of the apparatus is in tropical and/or moderate climates.)

	<p>Dispose of old batteries safely. Do not throw them into a fire.</p>
	<p>LASER SAFETY This unit utilizes laser technology. Only a qualified professional should remove the cover or attempt to service this device, due to possible eye injury.</p> <p>CAUTION</p> <ul style="list-style-type: none"> • Use of controls or adjustments or performance of procedure other than specified herein may result in hazardous radiation exposure. • Hazardous laser radiation when open and interlock defeated. <p>DANGER Invisible laser radiation when open and interlock failure. Avoid direct exposure to beam.</p>

USER SAFETY GUIDE

INSTRUCTIONS ON ENVIRONMENT PROTECTION

Do not dispose of this product in the usual household garbage at the end of its life cycle; bring it to a collection point for the recycling of electrical and electronic appliances. This symbol on the product means the instructions for use or the packing will inform about the methods for disposal. The materials are recyclable as mentioned in its marking. By recycling, material recycling, or other forms of re-utilization of old appliances, you make an important contribution to protect the environment. Please inquire at your local community administration for the authorized disposal location.



IMPORTANT SAFETY PRECAUTIONS

1. **READ INSTRUCTIONS** - All safety and operating instructions should be read before the appliance is operated.
2. **RETAIN INSTRUCTIONS** - The safety and operating instructions should be retained in a secure place for future reference.
3. **HEED WARNINGS** - All warnings on the appliance and in the operating instructions should be observed.
4. **FOLLOW INSTRUCTIONS** - All operating and use instructions should be followed.
5. **WATER AND MOISTURE** - The appliance should not be used near water. For example: near a bathtub, kitchen sink, laundry tub, and swimming pool or even in a wet basement.
6. **VENTILATION** - The appliance should be situated so that its location and position does not interfere with its proper ventilation. For example, the appliance should not be situated on a bed, sofa, rug or similar surface that may block the ventilation openings; or, be placed in a built-in installation, such as a bookcase or cabinet that may impede the flow of air through the ventilation openings.
7. **HEAT** - The appliance should be situated away from heat sources such as radiators, heat registers, stoves, or other appliances (including amplifiers) that produce heat.
8. **POWER SOURCES** - The appliance should be connected to a power supply only of the type described in the operating instructions or as marked on the appliance.
9. **GROUNDING AND POLARIZATION** - Precautions should be taken to ensure that the grounding or polarization of the appliance is correct.
10. **POWER CORD PROTECTION** - Power supply cords should be routed so that they are not likely to be walked on or obstructed by items placed upon or against them. Pay particular attention to cords at plugs, convenience receptacles, and the point at which they exit from the appliance.
11. **CLEANING** - The appliance should be cleaned only as recommended by the manufacturer.
12. **POWER LINES** - An outdoor antenna should be located away from power lines.
13. **NONUSE PERIODS** - The power cord of the appliance should be unplugged from the outlet when the appliance is to be left unused for an extended period of time.

USER SAFETY GUIDE

IMPORTANT SAFETY PRECAUTIONS – CONTINUED

14. **OBJECT and LIQUID ENTRY** - Care should be taken so that objects do not fall and liquids are not spilled into the device's openings.
15. **CARTS AND STANDS** - The appliance should be used only with a cart or stand that is recommended by the manufacturer. An appliance and cart combination should be moved with care. Quick stops, excessive force, and uneven surfaces may cause the appliance and cart combination to overturn. 
16. **WALL OR CEILING MOUNTING** - If the appliance is mounted to a wall or ceiling, it should be mounted only as recommended by the manufacturer.
17. **DAMAGE REQUIRING SERVICE** - The appliance should be serviced by qualified service professional when:
- The power-supply cord or plug has been damaged.
 - Objects have fallen into, or liquid has been spilled into the appliance's apertures.
 - The appliance has been exposed to rain.
 - The appliance has been dropped and suffered damage.
 - The appliance does not appear to operate normally or exhibits a marked change in performance.
18. **SERVICING** - The user should not attempt to service the appliance beyond that described in the user's operating instructions. All other servicing should be referred to qualified service professional.
19. **OUTDOOR ANTENNA GROUNDING** - If an outside antenna is connected to the receiver, be sure that the antenna system is grounded so as to provide some protection against voltage surges and built up static charges. Section 810 of the National Electrical Code, ANS/NFPA No. 70-1984 provides information with respect to proper grounding of the mast and supporting structure, grounding of the lead-in wire to an antenna discharge unit, size of grounding conductors, location of antenna discharge unit, connection to grounding electrodes, and requirements for the grounding electrode.

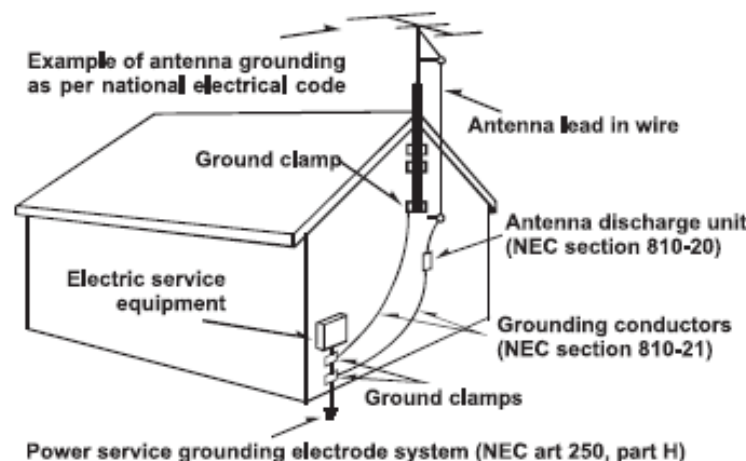

20. **PROTECTIVE ATTACHMENT PLUG** - The appliance is equipped with an attachment plug that has an overload protection. This is a safety feature. If replacement of the plug is required, be sure the service technician has used a replacement plug specified by the manufacturer that has the same overload protection as the original plug. (UK Version Only)

USER SAFETY GIUDE

FCC NOTICE (USA)

This equipment has been tested and found to comply with the limits for a Class B digital device, pursuant to Part 15 of the FCC Rules. These limits are designed to provide reasonable protection against harmful interference in a residential installation. This equipment generates, uses, and can radiate radio frequency energy and, if not installed and used in accordance with the instructions, may cause harmful interference to radio communications. However, there is no guarantee that interference will not occur in a particular installation. If this equipment does cause harmful interference to radio or television reception, which can be determined by turning the equipment off and on, the user is encouraged to try to correct the interference by one or more of the following measures:

1. Reorient or relocate the receiving antenna.
2. Increase the separation between the equipment and receiver.
3. Connect the equipment into an outlet on a circuit different from that to which the receiver is connected.
4. Consult the dealer or an experienced radio/TV technician for help.

This device complies with part 15 of the FCC Rules. Operation is subject to the condition that this device does not cause harmful interference.

- FCC regulations state that any change or modification to the equipment, not expressly approved by maker or its authorized parties, could void user's authority to operate this equipment.
- To prevent fire or electric shock, do not expose the unit to rain or moisture.
- Never attempt to open the cabinet. Dangerous high voltages are present in the unit. Always refer servicing to a qualified technician.

IC NOTICE (CANADA)

This digital apparatus does not exceed the Class B limits for radio noise emissions from digital apparatus as set out in the Radio Interference Regulations of Industry Canada. These limits are designed to provide reasonable protection against harmful interference in a residential installation. This equipment generates, uses, and can radiate radio frequency energy and, if not installed and used in accordance with the instructions, may cause harmful interference to radio communications. However, there is no guarantee that interference will not occur in a particular installation. If this equipment does cause harmful interference to radio or television operation (which can be determined by turning the equipment off), the user is encouraged to try to correct the interference by one or more of the following measures:

- Reorient or relocate the receiving antenna.
- Increase the separation between the equipment and receiver.
- Connect the equipment into an outlet on a circuit different from that to which the receiver is connected.

Consult the dealer or an experienced radio/TV technician for help.

TABLE OF CONTENTS

1. Getting Started	
a. Compatibility	6
b. Introduction	7
c. Location of Controls	8
d. Location of Controls (Remote)	10
e. Installing the Batteries in the Remote Control	10
f. Connecting the Player to a TV or Amplifier.....	11
g. Connecting the Player to the Car Adapter	11
h. Turning on the Unit	12
i. Using Headphones	12
2. Operational Instructions	
a. System Setup	13
b. Language Setup	14
c. Video Setup	15
d. Speaker Setup	15
e. Basic Playback Operation	16
3. Maintenance & Specifications	
a. Notes on CDs	19
b. Cleaning the lens	19
c. Cleaning the cabinet	19
d. Troubleshooting.....	20
e. Technical specifications	21

GETTING STARTED

COMPATIBILITY



DVD VIDEO



Multi-angle



AUDIO CD



Subtitle choices



MP3 CD



Audio choices



Kodak Picture CD

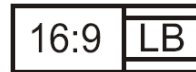

TV Aspect Ratio



Dolby® Digital

This product incorporates copyright protection technology that is protected by method claims of certain U.S. patents and other intellectual property rights owned by Macrovision Corporation and other rights owners. Use of this copyright protection technology must be authorized by Macrovision Corporation, and is intended for home and other limited viewing uses only unless otherwise authorized by Macrovision Corporation. Reverse engineering or disassembly is prohibited.

The product complies with the Kodak Picture CD format and will display Kodak Picture CDs. The "Kodak Picture CD Compatible" logo is a trademark of Eastman Kodak Company and is used with the permission.

Manufactured under license from Dolby Laboratories. "Dolby" and the double-D symbol are trademarks of Dolby Laboratories. Confidential Unpublished Works. © 1992 - 1997 Dolby Laboratories, Inc. All rights reserved.

GETTING STARTED

Thank you for purchasing the JD-VD762. Unpack the unit and make sure to put aside all accessories so they will not be lost. We recommend that you retain the original carton and packaging materials for future use, should you transport or ship the unit in the future.

Portable DVD Player with 9" Active Matrix TFT LCD

- 9" active-matrix TFT LCD
- Video output for external TV system
- Enhanced optical pickup system for disc stability & compatibility
- Anti Shock Protection (A.S.P.)
- Two Stereo headphone output
- Wireless remote control
- Rechargeable battery for maximum portability
- Power through either AC/DC or car adapter
- Built-in stereo speakers
- Multiple Angle function
- Multiple OSD / menu / subtitle / audio languages
- Support card: SD/MMC & USB HOST
- Slow / fast motion play
- Playable media: DVD / Kodak Picture CD compatible & JPEG readable / VCD / Audio CD / MP3 CD / CD-R / CD-RW

What's Included

- Portable DVD player
- Instruction manual
- Credit card shaped and sized remote control
- AC/DC power adapter
- Cigarette lighter adapter
- Rechargeable Battery Pack (7.4V / 2600 mAh)
- AV cable for TV connection



GETTING STARTED

Location of Controls

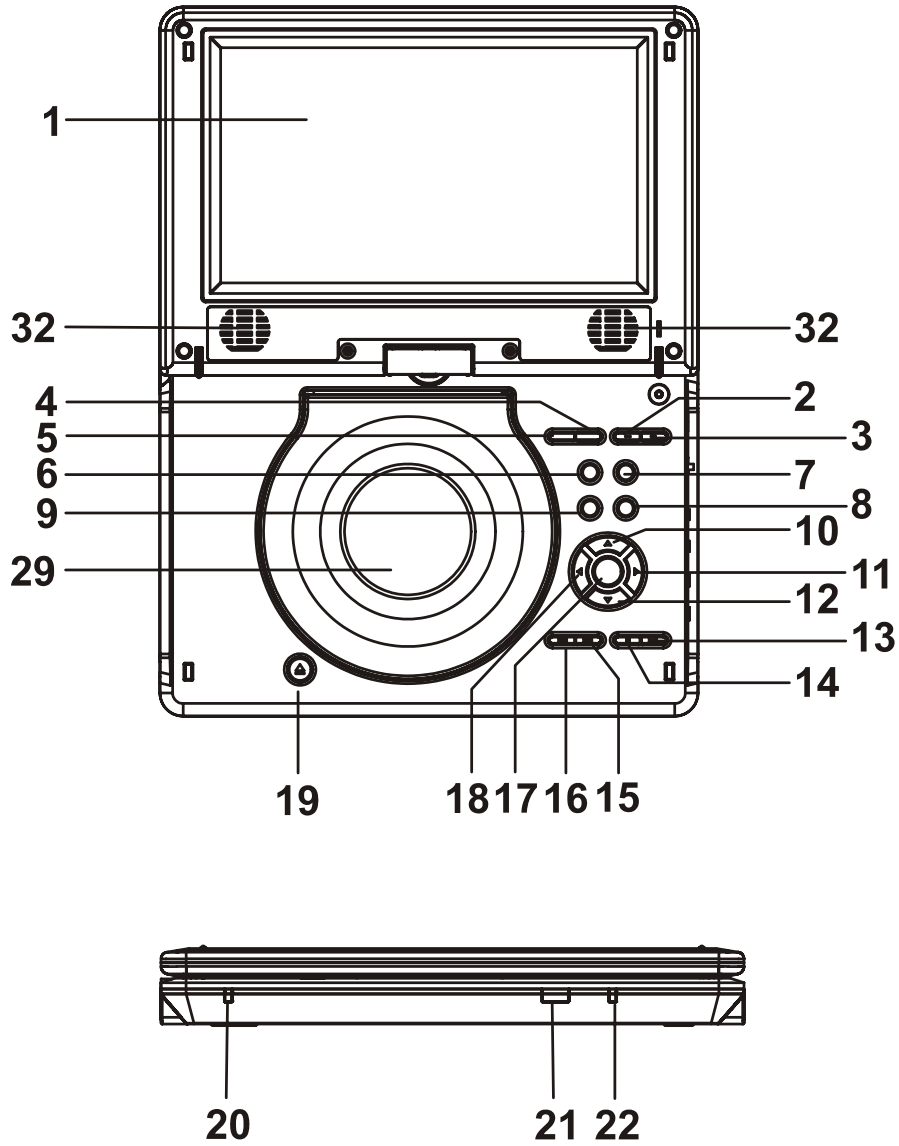

GETTING STARTED

Location of Controls-continued

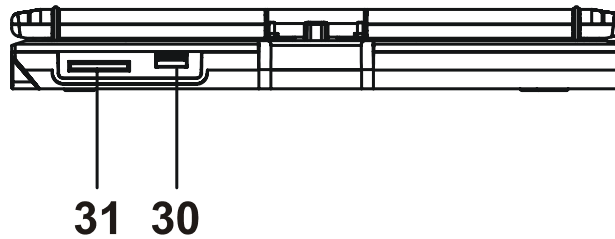
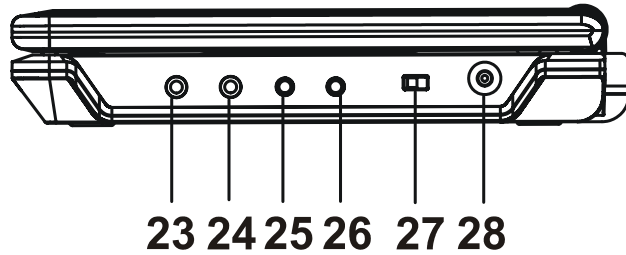

- | | |
|---------------------------------|-------------------------------|
| 1. LCD TFT Screen | 17. Enter Button |
| 2. Volume – Button | 18. Navigation Left Button |
| 3. Volume + Button | 19. Open Button |
| 4. Menu Button | 20. Charge Indicator |
| 5. Title Button | 21. Remote Sensor |
| 6. Display Button | 22. Standby Indicator |
| 7. Setup Button | 23. Phones Jack |
| 8. Audio Button | 24. Phones Jack |
| 9. Subtitle Button | 25. Audio Out Jack |
| 10. Navigation Up Button | 26. Video Out Jack |
| 11. Navigation Right Button | 27. Power Switch |
| 12. Navigation Down Button | 28. DC Input |
| 13. Play/Pause Button | 29. Disc Cover |
| 14. STOP&USB/SD/MMC Card Button | 30. USB Port |
| 15. NEXT&F.FWD Button | 31. Memory (SD/MMC) Card Slot |
| 16. PREVIOUS&F.BWD Button | 32. Speakers |

GETTING STARTED

Location of Controls-Remote

1. SCREEN ON/OFF & BRI/COL Button
2. TITLE Button
3. PREV./F. BKWD Button
4. NEXT/F. FWD Button
5. NAVIGATION Buttons
6. NUMERIC Buttons
7. PROGRAM/ANGLE Button
8. VOLUME - Button
9. ON/STANDBY Button
10. MENU Button
11. SETUP Button
12. DISPLAY Button
13. STOP-USB/SD/MMC Card Button
14. OK/ENTER-PLAY/PAUSE Button
15. SUBTITLE Button
16. AUDIO Button
17. SEARCH Button
18. REPEAT Button
19. ZOOM/SLOW Button
20. VOLUME + Button

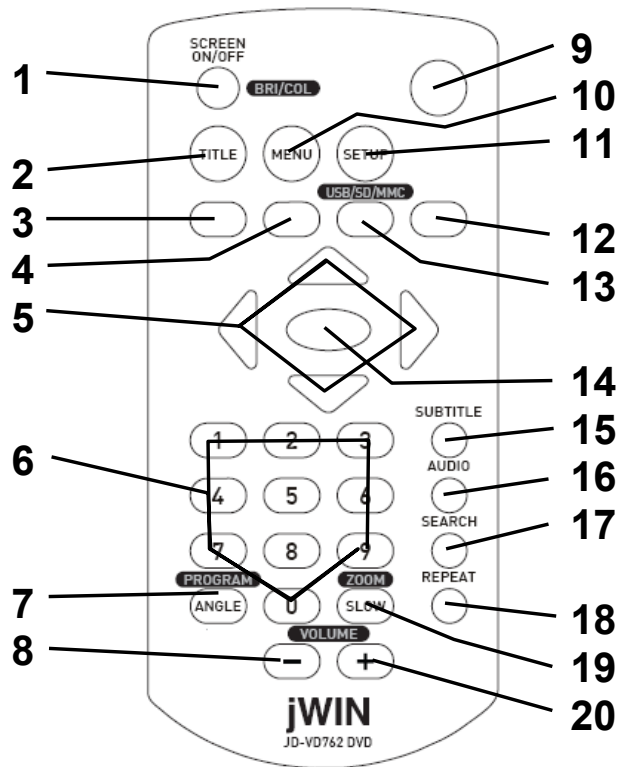

Installing the Batteries in the Remote Control

Open the **BATTERY DOOR** on the back of the remote control and insert two “AAA” size batteries (not supplied) making sure that the indicated battery polarity is observed. Once batteries are securely installed, close the **BATTERY DOOR**.

When not in use – Remove all the batteries if the unit will not be used for several months or more.

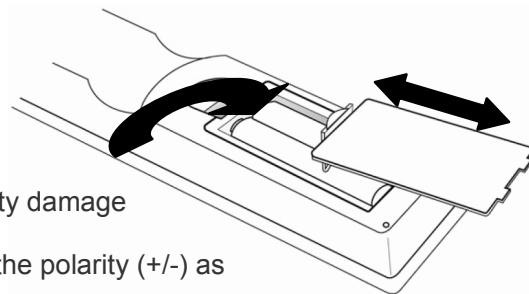

Notes on battery usage - To prevent battery leakage, which may result in bodily injury, property damage or damage to the unit, follow these instructions:

- a. Install all batteries correctly according to the polarity (+/-) as marked on the unit.
- b. Do not mix old and new batteries, carbon and alkaline, etc.
- c. Remove batteries from the unit when the device will not be used for an extended period of time.



You can help to protect the environment!

Please do not throw the used batteries away with other waste. Follow local regulations for the proper disposal of the used batteries.

GETTING STARTED

Connecting the Player to a TV or Amplifier

When connecting the JD-VD762 to other devices, it is recommended that a multi-system television is used. Before connecting this unit to a TV or amplifier, make certain that all devices, including the JD-VD762 are switched off, all AC cords are disconnected from wall outlets, and that ventilation holes are not blocked.

- Observe the color coding of all audio and video cables, matching them with the output jacks on all connected devices.

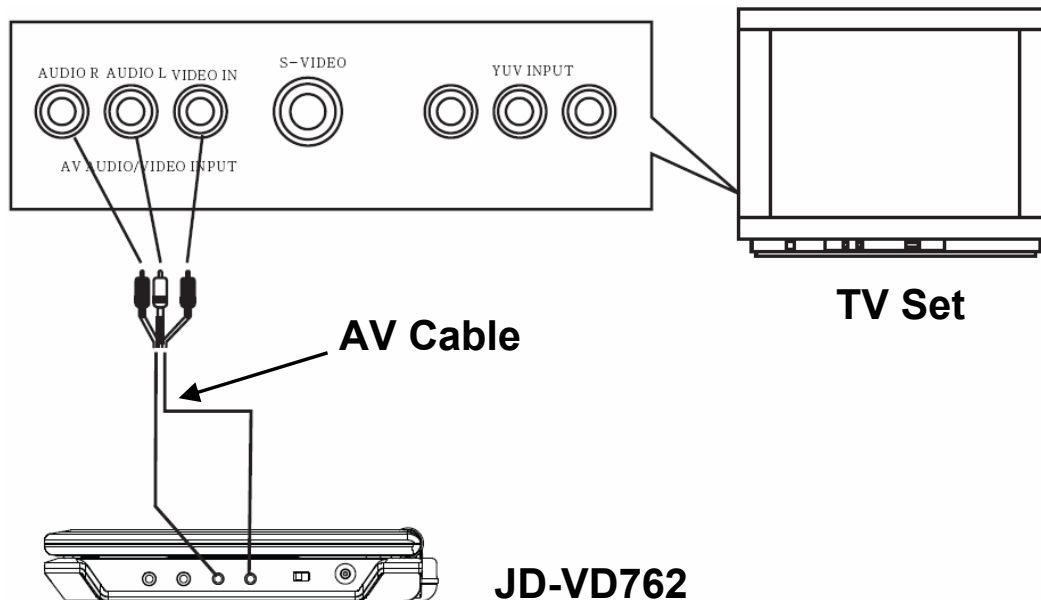

Once the JD-VD762 and all other appliances are securely connected, plug all units into AC wall outlets and switch the power on.

Connecting the Player to the Car Adapter

The included 9V car (cigarette lighter) adapter is designed for use in vehicles with a 12V negative grounded electrical system (most current automobile models).

Warning: Always disconnect the car adapter when not in use.

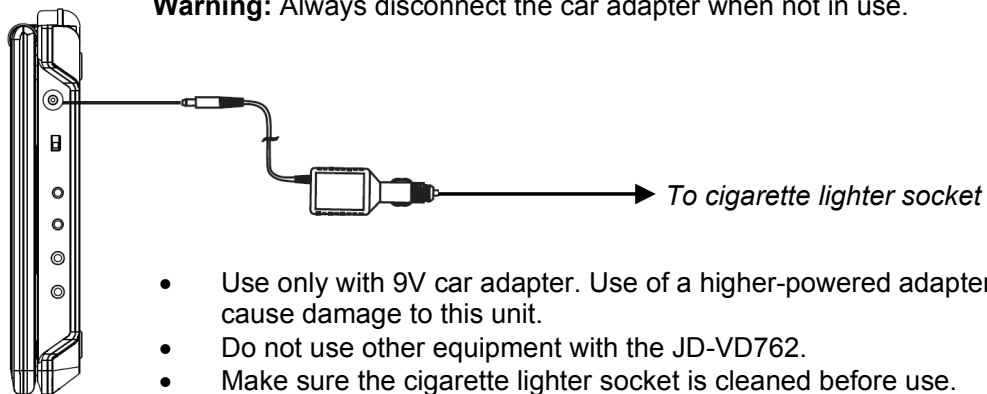

- Use only with 9V car adapter. Use of a higher-powered adapter, may cause damage to this unit.
- Do not use other equipment with the JD-VD762.
- Make sure the cigarette lighter socket is cleaned before use.
- After use, disconnect the 9V car (cigarette lighter) adapter from both the JD-VD762 and the cigarette lighter socket.

GETTING STARTED

Turning on the Unit

To turn on the JD-VD762, slide the **POWER** switch on the side of the unit to **ON** or press the **POWER** button on the remote control. (If connected to an amplifier or TV set, turn the connected device **ON**)

Using Headphones

This unit has a jack for connecting headphones (3.5MM). To connect headphones (not included), plug the headphone cable into the 3.5MM jack located on the side of the JD-VD762.

Cautions:

- Do not listen at high volume. This may cause the possible damage to or loss of hearing. If you experience a ringing in your ear, lower the volume or discontinue the use of headphones.
- Do not use headphones while driving or cycling. Warning sounds, such as an automobile horn, may not be heard and could result in a traffic accident.

Notes on headphone use:

- Turn the volume all the way down before connecting headphones.
- The speakers on this unit are disabled when headphones are plugged into the jack.
- Once connected, slowly raise the volume to a comfortable listening level.

OPERATIONAL INSTRUCTIONS

System Setup

The **SYSTEM SETUP** options are illustrated below:

1. TV SYSTEM

Choose the TV system best suited for your TV set. Available options are PAL, NTSC or AUTO. See user's manual for your TV set for guidelines.

2. LCD MODE

Choose the LCD mode. Available options are 4:3 or 16:9

3. TV TYPE

Depending on the TV screen to which you output, choose from aspect ratios 16:9, 4:3 LB, or 4:3 PS, Refer to the user's manual of your TV set for guidelines.

- **16:9:** The picture fills the screen using a wide screen angle.
- **4:3 LB:** Letter Box, two black bands appear in the upper and lower portions of the screen.
- **4:3 PS:** Pan and Scan, the image is cut in order to fill the entire screen.

4. DEFAULT

This option restores the unit to factory settings.

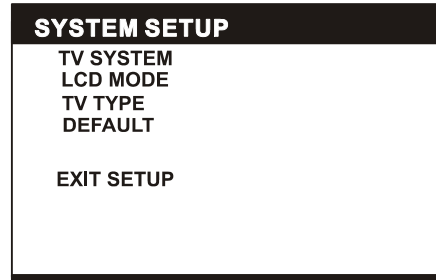

OPERATIONAL INSTRUCTIONS

Language Setup

The Language Setup options are illustrated below:

Note: The disc must be encoded with multiple languages in order to use these options. When your preferred language choice is not available, the disc will use its default language.

LANGUAGE SETUP

OSD LANGUAGE
AUDIO LANG
SUBTITLE LANG
MENU LANG

EXIT SETUP

1. OSD LANGUAGE

Highlight the **OSD LANGUAGE** option to choose the preferred language for On-Screen Display. Use the **NAVIGATION** buttons to highlight a language and press the **ENTER** button to confirm.

2. AUDIO LANG

Highlight the **AUDIO LANG** option using the **NAVIGATION** buttons to choose the language you prefer. Press the **ENTER** button to confirm.

3. SUBTITLE LANG

Highlight the **SUBTITLE LANG** option using the **NAVIGATION** buttons to choose the language you prefer. Press the **ENTER** button to confirm.

4. MENU LANG

Highlight the **MENU LANG** option using the **NAVIGATION** buttons to choose the language you prefer. Press the **ENTER** button to confirm.

OPERATIONAL INSTRUCTIONS

Video Setup

The Video Setup options are illustrated below:

1. BRIGHTNESS

Highlight the **BRIGHTNESS** option using the Up and Down (**▲▼**) **NAVIGATION** buttons to adjust the brightness.

Note: The **BRI/COL** (Brightness/Color) feature can be used by pressing this button on the remote control once for brightness or twice for color. Use the left and right (**◀▶**) buttons to make changes.

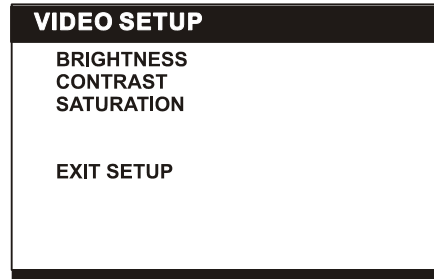

2. CONTRAST

Highlight the **CONTRAST** option using the Up and Down **NAVIGATION** buttons to adjust the contrast.

3. SATURATION

Highlight the **SATURATION** option using the Up and Down (**▲▼**) **NAVIGATION** buttons to adjust the saturation.

Speaker Setup

The Speaker Setup options are illustrated below:

- **DOWNMIX**
 - **LT/RT:** Choose this setting when connected to a 2-channel analog audio input.
 - **STEREO:** Choose this setting when the DVD player is connected to a TV or modulator.

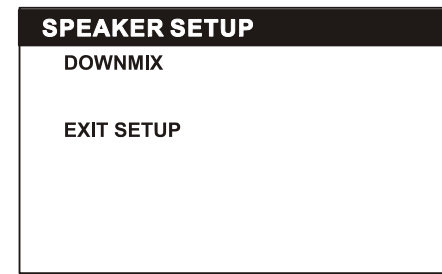

OPERATIONAL INSTRUCTIONS

Basic Playback Operation

Place a disc in the tray. Playback will start automatically.

1. ADJUSTING THE VOLUME

Press the **VOLUME+** button to increase the volume or the **VOLUME –** button to reduce the volume.

2. SKIP FORWARD/BACKWARD

Press the **NEXT** or **PREV** buttons once to skip a chapter (on a DVD) or track (on a VCD/CD) forward or backward.

3. FAST FORWARD/BACKWARD

During playback (CD/DVD/VCD), press and hold the **NEXT** button or **PREV** button on the remote control or press and hold the **NEXT** button or **PREV** button on the main unit to scan forward or backward on the disc. Speed increased at X2, X4, X8, or X20 normal speed. Press the **PLAY** button to resume normal playback.

4. PAUSE FUNCTION

During playback, press the **PAUSE** button to pause. While in Pause mode, press the **PAUSE** button to play one frame with each press. Press the **PLAY** button to resume normal playback.

5. STOP

During playback press the **STOP** button to stop playback. Press the **STOP** button to activate the Resume function so that when the **PLAY** button is pressed, the playback will resume at the same place where playback stopped. To disable this function, press the **STOP** button again.

6. SLOW MOTION PLAYBACK (DVD/VCD)

During Playback, press the **SLOW** button to decrease the playback speed to 1/2, 1/3, 1/4, 1/5, 1/6, to 1/7 normal playback speed. Press the **PLAY** button to resume normal playback.

7. REPEAT

During playback, press the **REPEAT** button to repeat one chapter/title or repeat all (for a DVD), or to repeat a track or all tracks (on a VCD or CD) or to repeat sections between two points (A-B).

Note: For a VCD, the Repeat function only works in the **PBC OFF** mode.

8. SEARCH

- During playback, press the **SEARCH** button to choose a title, chapter, or chapter time to be played. Use the **NAVIGATION** buttons to select.
- Use the Number keys to make the selection.
- Press the **ENTER** button on the main unit or the **OK** button on the remote control to confirm and begin playback from the selected item.
- Press the **SEARCH** button again to exit this function.

OPERATIONAL INSTRUCTIONS

Basic Playback Operation-continued

9. PROGRAMMED PLAYBACK

This unit has 16 a track programmable memory that allows you to program up to 16 tracks on any disc for playback in any desired order. Program up to 16 tracks or program certain tracks to play more than once. To perform programmed playback, proceed as follows:

- While in the **PLAY** or **STOP** mode, press the **PROGRAM** button. The program window will appear on the screen.
- Press the numeric buttons to input track numbers or title / chapter numbers in the order you want them to play. Use the **NAVIGATION** buttons to move the cursor.
- When all desired tracks or titles/chapters have been programmed (up to 16). You can repeat a track or title/chapter more than once if desired.
- Use the **NAVIGATION** buttons to select the **START** position, and then press the **PLAY** button to begin the programmed play.
- To clear Programmed items, press the "0" button on the remote control. To clear all items, select the Clear option from the program menu and press the **ENTER** button on the main unit or the **OK** button on the remote control.
- To cancel the program function, press the **PROGRAM** button.

10. ZOOM

This player can magnify a picture. Press the **ZOOM** button to zoom during normal, slow or still playback mode. Use the Navigation Buttons to select the desired part of the zoomed picture.

Note: This function only works with DVD and VCD discs.

11. ON SCREEN DISPLAY (OSD) INFORMATION

Press the **DISPLAY** button to show the elapsed and remaining time of the playing disc. Each time the **DISPLAY** button is pressed, the time will change on the screen as follows:

- *DVD*: Chapter Elapsed ⇨ Chapter Remain ⇨ Title Elapsed ⇨ Title Remain ⇨ Display Off
- *VCD & CD*: Single Elapsed ⇨ Single Remain ⇨ Total Elapsed ⇨ Total Remain ⇨ Display Off
- *MP3 CD*: Single Elapsed ⇨ Single Remain ⇨ Display Off

12. AUDIO FEATURE

This player allows the viewer to hear audios in as many as eight languages. To choose the playback audio language, follow these instructions.

- Press the **AUDIO** button to display the audio Language Menu.
- Choose your desired playback audio language and press the **AUDIO** button again. The audio language varies depending on the disc inserted. For audio CD and Video CD, it will change the audio mode as follows: MONO LEFT/MONO RIGHT/ STEREO.

13. MULTI-ANGLE VIEWING

Some DVD discs may contain scenes which have been shot simultaneously from a number of different camera angles. This function depends on a disc.

- Play a DVD disc that is recorded with multiple angles.
- Press the **ANGLE** button. If the disc contains different angled views, it will show the movie with the chosen different angle.
- To return the normal angle view, press the **ANGLE** button again.

14. SUBTITLE FEATURE

Press the **SUBTITLE** button to select a subtitle language. To turn off the subtitle, press the **SUBTITLE** button repeatedly. This feature is not available on all discs.

OPERATIONAL INSTRUCTIONS

Basic Playback Operation-continued

15. PBC FEATURE

When playing a VCD with PBC function, you can enjoy simple interactive software on the TV screen. By turning on this function, desired tracks can be selected by pressing the numeric buttons. This feature is enabled only when a VCD2.0 disc supports the PBC feature. After selecting a track, press the **ENTER** button to start playing the selected track. Press the **MENU** and choose PBC ON/OFF to activate or deactivate the function

16. MP3 PLAYBACK

- Load an MP3 CD into the disc tray. All folders will display on the screen.
- Select the desired folder using the **NAVIGATION** buttons and press the **ENTER** button on the main unit or **OK** button on the remote control to confirm.
- Use the **NAVIGATION** buttons to select the desired song and press the **ENTER** button on the main unit or the **OK** button on the remote control to confirm. Playback will begin automatically.
- Press the **NEXT** or **PREV** buttons to select a track directly
- Press the **REPEAT** button to change the play mode: **REPEAT 1** repeats one file; **REPEAT DIR** repeats all tracks in the current album; **REPEAT ALL** repeats all tracks on the current disc; **REPEAT OFF** cancels the repeat modes.

17. KODAK PICTURE CD/JPEG CD PLAYBACK

For Kodak picture CDs or JPEG CDs follow these instructions:

- **Play Modes**- Press the REPEAT button to change the play modes: **REPEAT 1** repeats one file; **REPEAT DIR** repeats all tracks in the current album; **REPEAT ALL** repeats all tracks on the current disc; **REPEAT OFF** cancels the repeat modes.
- **Next/Previous Picture**- Press the **NEXT** button to skip to the next picture or the **PREV** button to view the previous picture. If no button is pressed, it will skip to the next picture automatically
- **Rotating the Picture**- Press the right and left **NAVIGATION** buttons to rotate the pictures clockwise and counter-clockwise.
- **Inverting the Picture**- Press the up or down **NAVIGATION** buttons to flip a picture vertically or horizontally.
- **Zoom**- Press the **ZOOM** button continuously to zoom in by 2, 3 or 4 times and to zoom out by 1/2, 1/3, 1/4 the original size. Use the **NAVIGATION** buttons to select a certain part of the picture to zoom.
- **Slide Show Transition**- During slide show playback, press the **PROGRAM** button to enter the slide show transition mode. During playback, press the **STOP** button once to enter thumbnail mode; press **STOP** button twice to enter the File Manager mode. Use the **NAVIGATION** buttons to select.

MAINTENANCE

Notes on CDs

1. Before playing, clean the CD with a cleaning cloth. Wipe the CD from the center out to the ends.
2. Do not use solvents such as benzine, thinner, commercially available cleaners or anti-static spray intended for vinyl LPs.
3. Do not expose the CD to direct sunlight or heat sources such as hot air ducts. Do not expose to direct sunlight, nor leave CDs in a car, as there can be a considerable rise in temperature.
4. Do not stick paper or sticker on the CD. Do not scratch, dirt or fingerprints on the CD, for it may cause tracking error.

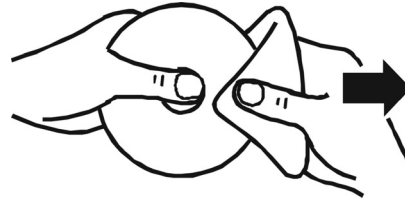

Cleaning the lens

If the lens becomes dirty, it may cause a skipping of sound during CD operation. Clean with a commercially available lens cleaner.

Cleaning the cabinet

Clean the cabinet, panel and controls with a soft cloth slightly moistened with a mild detergent solution. Do not use any type of abrasive pad, scouring powder, or solvent, such as alcohol or benzine.

TROUBLESHOOTING GUIDE

When the instructions in this manual are followed, this unit should function properly. However, if any of the following difficulties occur and cannot be corrected by the user or if a problem arises that is not mentioned here, please contact jWIN Customer Service or a qualified service technician.

1. Unit Does Not Play
 - Unit may be disconnected from power source. Check connection.
 - Disc is not correctly set. CDs should be inserted label side up.
 - Disc is scratched or dirty. Please clean.
 - The lens is dirty. Wipe clean gently with soft, dry cloth. Follow the instructions of the lens cleaner.
 - There is moisture on the lens wait an hour and try again.
2. No Sound or Feedback
 - Ensure plugs are inserted firmly.
 - Wipe off plugs with clean cloth.
 - Disc is scratched or dirty. Please clean.
 - Volume control is turned down. Please increase.
3. Sound from Only One Side (or inverted)
 - Speaker cords are not properly connected.
 - Input cords are not properly connected.
 - Left/Right balance may not be properly adjusted.
4. No Sound from center/surround speakers
 - Downmix settings are incorrect. Please adjust settings.
 - Disc or program is only recorded in stereo. Set Pro Logic II on.
5. No Picture
 - Video equipment may be disconnected. Check connections.
 - Incorrect output setting for video function. Check Output settings in general setup.

SPECIFICATIONS

- Solution: Sunplus SPHE8202D
- Loader: Samsung SP1CHU
- TV System: NTSC / PAL / AUTO
- Aspect Ratio: 16:9 / 4:3LB / 4:3PS
- LCD Panel
 - Diagonal Size: 9"
 - Viewing Angles: (-60 ~ 60 Horizontal) / (-60 ~ 40 Vertical) (Typ.)
- Audio Output Power
 - RMS output at 10% THD: 0.12W
 - Maximum output: 1.2W
- Inputs & Outputs
 - Video Output Jack
 - Audio Output Jack
 - 3.5mm Stereo Headphone Jack
 - Power Adapter (AC/DC and Car) Input Jack
- Power Sources
 - 9V (AC/DC) Power Adapter
 - Ni-MH Rechargeable Battery (7.4V / 2600mAh)
 - Cigarette lighter Adapter
- Power Consumption: 15W

* Specifications and features are subject to change without prior notice.

jWIN

TEL: 516-626-7188

FAX: 516-626-7105

website: www.jWIN.com

© 2008 jWIN Electronics Corp. All rights reserved. No portion of this printed material or product enclosed herewith including design, shape and graphics, may be reproduced or transmitted in any form without prior written consent of jWIN Electronics Corp. by any means, electronic or mechanical, including photocopying, recording or use of an information storage and retrieval system. Any unauthorized distribution or reproduction of this printed material or product, or any portion thereof, will be prosecuted to the fullest possible extent of the law.

Printed in China