

DELPHI

User Guide

Premium Sound System



(SKYFi3 receiver sold separately)



Important: This manual contains important safety and operating information. Please read, understand, and follow the instructions in this manual. Failure to do so could result in personal injury, death, and/or damage to your Delphi Premium Sound System, accessories, and/or to your vehicle or property.



This is the safety alert symbol. It is used to alert you to potential personal injury hazards. Obey all safety messages that follow this symbol to avoid possible injury or death.



Warning: To prevent fire or shock hazard, do not expose the Delphi Premium Sound System to rain, moisture or water.

This device complies with part 15 of the FCC rules. Operation is subject to the following two conditions:

1. This device may not cause harmful interference, and
2. This device must accept any interference received, including interference that may cause undesired operation.

This Class B apparatus complies with Canadian ICES-003.

The Delphi XM® SKYFi2® and RodyXT® Satellite Radio Receiver each incorporate an FM transmitter and are thereby classified as intentional transmitters. Changes or modifications not expressly approved by Delphi could void your authority to operate this equipment.



Warning: The FCC and FAA have not certified the SKYFi3®, MyFi®, or Rody XT® for use in any aircraft (neither portable nor permanent installation). Use of these devices in an aircraft could interfere with the aircraft navigation or communication devices and result in an accident including fatal injuries and/or property damage.



Attention: Do not place your sound system directly on or near credit cards or hard drives. This product contains powered magnetic speaker drivers that may impact, alter, destroy, and/or erase magnetic data storage.

Owner's Record

The model number is located below and the serial number is located on the label on the rear of the Delphi Premium Sound System.

Record the serial number in the space provided below. Refer to these numbers whenever you call your dealer regarding this product.

Model No.: DELPHI SA10221

Serial No.: _____

Delphi Premium Sound System Controls:

DELPHI

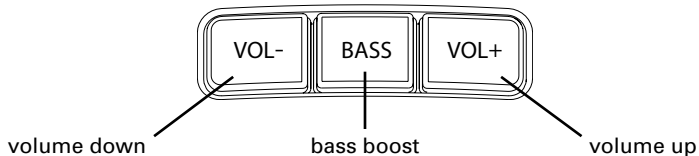

MAXX Bass[®]

Battery

on off

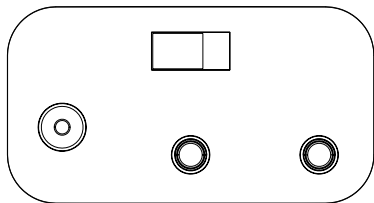

18V DC



Aux In



Headphone

Need help?

Call us at 1.877.GO.DELPHI

Monday through Friday from 8:00 a.m. - 8:00 p.m. Eastern Time
Saturday and Sunday from 10:00 a.m. - 4 :00 p.m Eastern Time
Note: Extended seasonal hours may be available.

Thank you for purchasing the Delphi Premium Sound System. We've designed many thoughtful features into this system to ensure that your level of listening enjoyment is the very best it can be.

In the event that you have questions or trouble getting started with your new system, **please do not return to the store**. Call us first! We can help.

Technical Support is also available at www.shopdelphi.com/skyfi3support.

All features and functions are subject to change without notice.

Contents

Welcome.....	3
About Delphi.....	3
Getting Started.....	4
What's in the Box.....	4
Setting up the System.....	5
Installing the Cradle.....	6
Power up the System.....	7
Using SKYFi3®.....	8
Using MyFi®.....	10
Using Rody® XT.....	12
Using Audiovox® Xpress™.....	14
Using Batteries.....	16
Setting up the Antenna.....	18
Optimizing Antenna Position/Signal.....	18
Positioning the XM Antenna.....	19
Indoor Installation on a Flat Surface.....	20
Outdoor Installation or Indoor Wall Mounting.....	20
Repeater Antenna.....	23

Using the Delphi Premium Sound System.....	24
Volume.....	24
Bass Boost.....	24
Headphones.....	24
Aux In.....	26
Other Things You Should Know.....	27
Precautions.....	27
Troubleshooting.....	28
Maintenance.....	29
Specifications.....	30
Warranty.....	31
Delphi Limited Consumer Warranty United States of America.....	31
Delphi Limited Consumer Warranty Canada.....	33

Welcome

Thank you for purchasing the new Delphi Premium Sound System. You are just minutes away from being able to play more than 170 crystal clear channels of live XM® satellite radio on a precisely engineered speaker system.

Read the following pages to get started with your new Delphi Premium Sound System.

About Delphi

Delphi is a world leader in mobile electronics, vehicle components and audio technology. Delphi created the first in-dash car radio in 1936 and continues its strong tradition of innovation in the audio industry. Delphi technology has helped make satellite radio a reality, and Delphi continues to expand its in-vehicle and consumer electronics technologies. With its exciting line of satellite radio products, Delphi offers a broad portfolio of products to answer a wide variety of information and entertainment needs—in the vehicle, home, office, or virtually anywhere.

What's In the Box

Your Delphi Premium Sound System Kit contains the following components:

Items in the box

1. Premium Sound System
2. Radio cradle inserts for Roady® XT, MyFi®, SKYFi3® and Audiovox® receivers
3. Repeater Antenna Bracket and mounting screws
4. 18 volt power supply with separate cord (not pictured)
5. User Guide (not pictured)
6. Satellite home antenna (included inside the Premium Sound System)

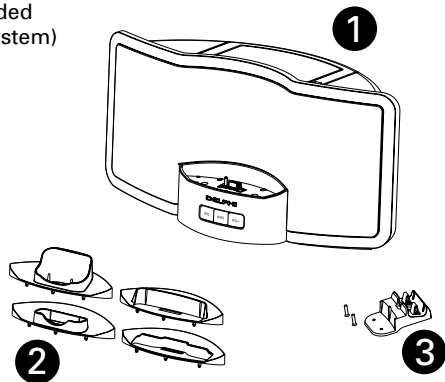

Setting Up the System

You can set up your Delphi Premium Sound System by following these steps:

1. Connect the supplied 18-volt DC power adaptor to the jack on the rear of the Delphi Premium Sound System. Plug the other end into the wall outlet. You may also use 8 "C" batteries (not included).
2. The XM Antenna is located under the top cover of the Delphi Premium Sound System. If needed (i.e. unit is placed away from a south facing window or you live in an area without XM terrestrial repeaters), lift the handle on the top of the unit and remove the cover to access the antenna and wire management area.

Remove the cover by pressing down on the two tabs with your thumbs and sliding the cover away from the front of the Delphi Premium Sound System. Be sure that the antenna is connected to the antenna jack located inside the antenna compartment on the top of the Delphi Premium Sound System.

You can wind the two cable hooks in the compartment, leaving just enough cable

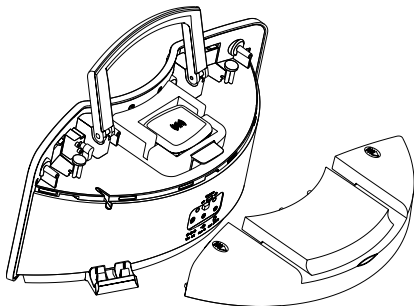

to attach the antenna to the four tabs on the back of the Delphi Premium Sound System. Or you can extend the entire 20' cable away from the system to improve reception. To reattach the top cover, line up all tabs and then slide the cover toward the front of the unit until a click is heard. Make certain that all tabs are engaged and the rear of the panel is aligned with the rear cover.

Installing the Radio Cradle

Before installing the cradles, be sure to choose the proper cradle from the options that are included in the package. The receiver name is printed on the bottom of each cradle insert.

Insert your satellite receiver (which is sold separately) into the cradle. Slide the receiver down into the cradle so that the radio lines up with the slots on the receiver and the connector is completely seated. The receiver can be removed by reversing this process.

Power Up the System

Use the power button on the receiver or on its remote control to turn on the receiver. If the display reads “ANTENNA” after powering up, check that the antenna connection is secure and completely pushed in. Next, change channels (from 0 to 1 or from 1 to 0 if the receiver is not authorized yet).

NOTE: Some receivers will power up automatically when installed in the Delphi Premium Sound System.

If the “ANTENNA” message remains, power down the radio, unplug the antenna and look for any obvious damage in the connector, jack or antenna cable. If no damage is detected, reconnect the antenna, turn the unit back on, and change channels again. If the message still appears, contact your retailer.

If the display reads “NO SIGNAL” after powering up, follow the instructions in “Setting up the Antenna” on page 5.

Using SKYFi3® with Delphi Premium Sound System

1. Install the SKYFi3 cradle insert onto the Delphi Premium Sound System. Insert the SKYFi3 receiver (sold separately) into the cradle insert included with the Delphi Premium Sound System until snug.

Caution: Do not use excessive force when inserting the receiver into the cradle. Doing so could cause damage to the unit.

2. Place the cradle insert containing the SKYFi3 into the cradle by first pressing in on the back of the black inset cradle in the Delphi Premium Sound System. Then let the cradle tilt forward, carefully slide the cradle insert down into the tray so that the alignment tabs on the sides of the tray line up with the slots on the cradle insert and the connector is completely seated. Push on the top center above the display of the cradle insert so that it tilts back into the Delphi Premium Sound System until a click is heard. The SKYFi3 Receiver adaptor can be removed by reversing this process.
3. Power up the system by using the power button on the receiver or on the remote control. If the display reads “ANTENNA” after powering up, check that the antenna connection is secure and completely pushed in. Next, change channels (from 0 to 1 or from 1 to 0 if the receiver is not activated yet). If the “ANTENNA” message remains, power down the radio, unplug the antenna, and look for any obvious damage in the connector, jack, or antenna cable. If no damage is detected, reconnect the antenna, turn the unit back on, and change channels again. If the message still appears, contact your retailer.

4. If the display reads "NO SIGNAL" after powering up, follow the instructions in "Setting up the Antenna" on page 18.

NOTE: Getting started instructions on all receivers are the same with the exception of having to turn on the MyFi on the receiver and adjusting the separate volume control on that receiver as well.

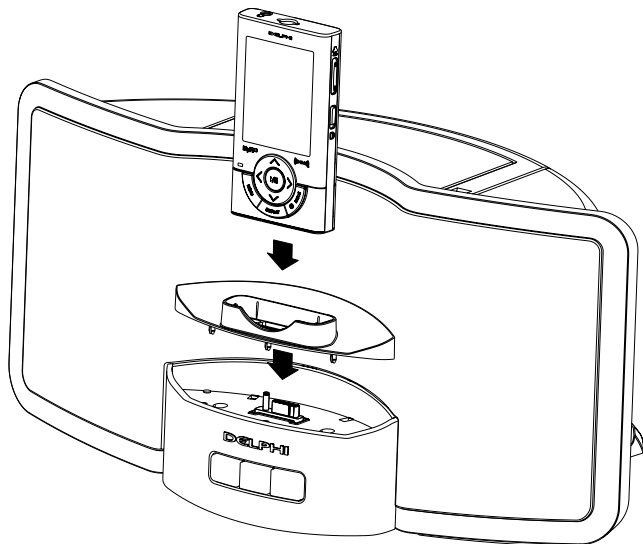

Using MyFi® with Delphi Premium Sound System

Special note for MyFi receivers: If you have purchased the MyFi unit, you must turn on the MyFi switch located in the battery compartment of the Premium Sound System. Sliding this switch to “2” position will make the Premium Sound System compatible with MyFi radios.

For all other radios this switch should be in “1” position and the Premium Sound System should operate normally.

1) What happens if the Premium Sound System is not switched to correct mode to position 2 (while a MyFi is plugged in)?

Volume and base boost buttons on the Premium Sound System will not change the volume level.

2) What happens if the MyFi switch is in the “2” position and we use the MyFi?

Volume can be changed both on the MyFi unit and using the buttons on the Delphi Premium Sound System.

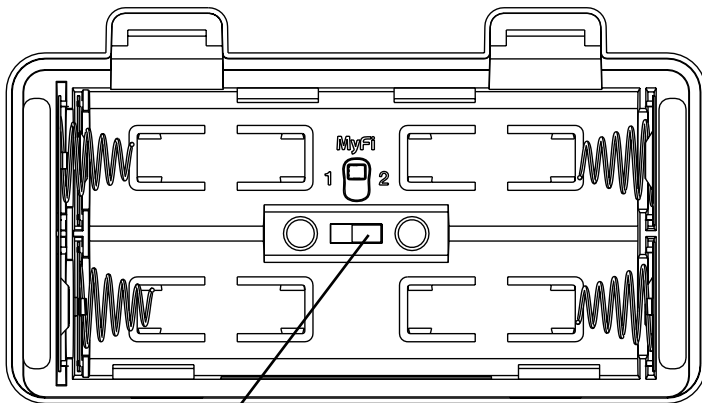

Switch to "2" position to use your MyFi with the Delphi Premium Sound System.

Using Rody® XT with Delphi Premium Sound System

1. Install the Rody XT cradle onto the Delphi Premium Sound System. Insert the Rody XT Receiver (sold separately) into the adaptor included with the Delphi Premium Sound System until snug.

Caution: Do not use excessive force when inserting the receiver into the cradle. Doing so could cause damage to the unit.

2. Insert the adaptor containing the Rody XT into the cradle by pressing in on the back of the black inset cradle in the Delphi Premium Sound System. Then let the cradle tilt forward and carefully slide the adaptor down into the tray so that the alignment tabs on the sides of the tray line up with the slots on the adaptor and the connector is completely seated.

Push on the top center above the display of the adaptor so that it tilts back into the Delphi Premium Sound System until a click is heard. The Rody XT receiver adaptor can be removed by reversing this process.

3. Power up the system by using the power button on the receiver or on the remote control. If the display reads "ANTENNA" after powering up, check that the antenna connection is secure and completely pushed in. Next, change channels (from 0 to 1 or from 1 to 0 if the receiver is not activated yet). If the "ANTENNA" message remains, power down the radio, unplug the antenna and look for any obvious damage in the connector, jack or antenna cable. If no damage is detected, reconnect the antenna, turn the unit back on and change channels again. If the message still appears, contact your retailer.

4. If the display reads "NO SIGNAL" after powering up, follow the instructions in "Setting up the Antenna" on page 18.

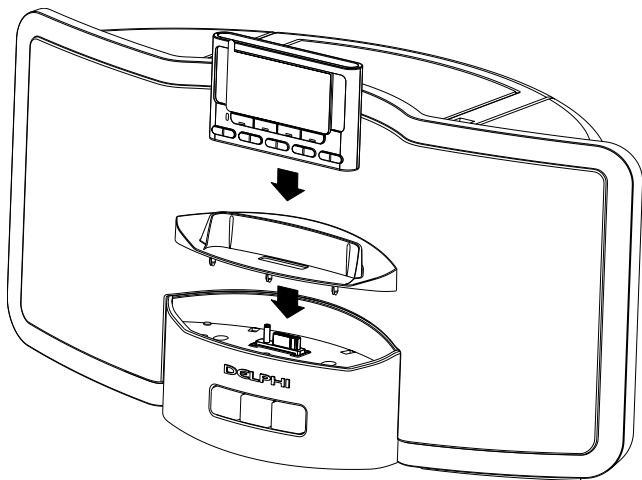

Using an Audiovox® Receiver with Delphi Premium Sound System

1. Install the Audiovox cradle onto the Delphi Premium Sound System. Insert the Audiovox receiver (sold separately) into the cradle insert included with the system until snug.

Caution: Do not use excessive force when inserting the receiver into the cradle. Doing so could cause damage to the unit.

2. Place the cradle insert containing the Audiovox receiver into the cradle by first pressing in on the back of the black inset cradle in the system. Then let the cradle tilt forward, carefully slide the cradle insert down into the tray so that the alignment tabs on the sides of the tray line up with the slots on the cradle insert and the connector is completely seated. Push on the top center above the display of the cradle insert so that it tilts back into the system until a click is heard. The Audiovox receiver cradle insert can be removed by reversing this process.
3. Power up the Delphi Premium Sound System by using the power button on the receiver or on the remote control. If the display reads “ANTENNA” after powering up, check that the antenna connection is secure and completely pushed in. Next, change channels (from 0 to 1 or from 1 to 0 if the receiver is not activated yet). If the “ANTENNA” message remains, power down the radio, unplug the antenna and look for any obvious damage in the connector, jack or antenna cable. If no damage is detected, reconnect the antenna, turn the unit back on and change channels again. If the message still appears, contact your retailer.

4. If the display reads “NO SIGNAL” after powering up, follow the instructions in “Setting up the Antenna” on page 18.

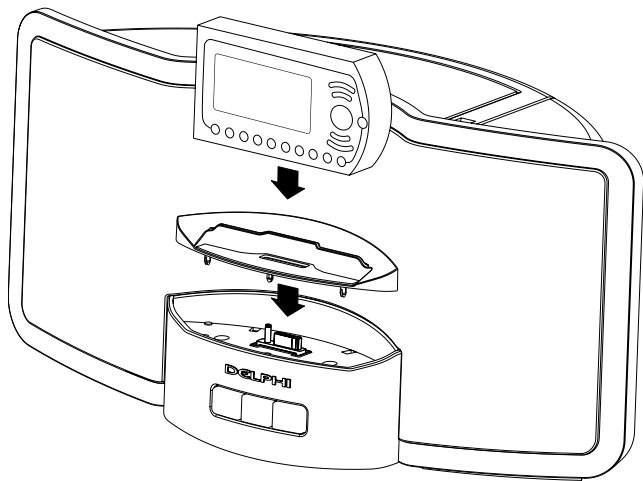

Using the Delphi Premium Sound System with Batteries

The Delphi Premium Sound System can be used with batteries (not included) to allow you to listen to XM outdoors or in other locations without access to an AC power source. Alkaline or rechargeable NiCD batteries are recommended. Battery life will vary depending on how the system is operated and the type of batteries being used. It is recommended that the AC adaptor be the primary power source for the Delphi Premium Sound System in order to preserve battery life. **Note: The Delphi Premium Sound System does not charge rechargeable batteries.**

1. Disconnect the power adaptor from the back of the Delphi Premium Sound System.
2. Remove the battery compartment cover.
3. Insert 8 “C” size batteries into the battery compartment. Make sure that the batteries are facing the correct direction by verifying that the positive (+) and negative (-) symbols in the battery compartment match up with the same symbols on the batteries.
4. It is recommended that the batteries be removed when system is not in use for an extended period of time.
5. When unit is not in use, use the Battery Save switch on the back of the Delphi Premium Sound System to extend battery life.

Back Cover Battery Switch

To keep the batteries from draining when not in use, switch the button to OFF position. The function of the Battery switch in the rear is to provide protection against battery drainage when Premium Sound System is not plugged into the wall.

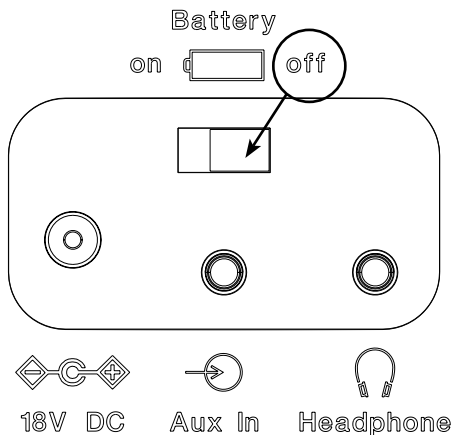

The antenna that comes with the Delphi Premium Sound System is a high-gain antenna that can receive the XM signal from XM's satellites and/or XM's land-based repeaters (depending on where you live). It is recommended that the antenna be positioned near a south-facing window or outdoors with a clear view of the southern sky in order to receive the satellite signal. In some cases, it will be possible to receive the XM signal through standard home walls or a roof.

To position your antenna, first set up the Delphi Premium Sound System as described in this guide. Next, position the antenna until you receive the strongest possible satellite signal. If the satellite signal is not available, you can optimize it for a terrestrial signal (where available).

Optimizing Antenna Position/Signal

1. Press the "Power" button on the receiver to turn on the Delphi Premium Sound System.
2. Press the "Menu" button.
3. Using the scroll wheel, turn the wheel until "Antenna Aiming" is highlighted.
4. With "Antenna Aiming" still highlighted, press the "Enter" button found in the center of the scroll wheel. The display will show the strength of the satellite and/or terrestrial signals. The antenna signal strength is indicated by the number of filled bars.



Caution: Do not set anything on top of the Premium Sound System as it may reduce antenna signal reception.

Positioning the Antenna

When outdoors with a view of the southern sky, or in an area of repeater coverage, or when receiving a strong signal indoors, you can conveniently leave the antenna under the top cover and secure the wires under the cover.

1. Remove the antenna cable storage cover as described in “Setting Up the System,” wind the antenna around the two cable hooks, leaving several inches of cable free, and replace the cover.
2. Fold the antenna down flat against its base.
3. Use the “Antenna Aiming” screen as described in “Optimizing Antenna Position/Signal” to optimize the antenna tilt angle and position.

If you are unable to receive a signal, then position the antenna as described in one of the next two sections.

Indoor Installation on a Flat Surface

To aim your antenna at the satellite:

1. Set antenna flat against its base on a flat (horizontal) surface.
2. Turn the base of the antenna so that the XM logo is facing to the south.
3. Use the “Antenna Aiming” screen to optimize antenna tilt angle and position.
4. If necessary, experiment with different locations near a south-facing window or outdoors.

Your antenna comes with 20’ of cable. If that is not sufficient to locate the antenna where there is a strong XM signal, purchase the Delphi XM Signal Repeater (Delphi model number SA10116) from your retailer or www.shopdelphi.com. Visit www.shopdelphi.com for more information about this accessory.

There is also a 50’ extension cable for the antenna (SA10006) that is sold separately.

Outdoor Installation or Indoor Wall Mounting

The antenna can also be attached vertically to an external or internal wall if that is more convenient than placing it on a horizontal surface.

1. Holding your antenna up, find a wall location that ensures a strong signal. It is recommended that you use an extension cord to temporarily locate your receiver’s home stand outdoors while optimizing the antenna location with the “Antenna Aiming” screen.

2. Attach four screws to the wall using the screw-locator pattern shown below. Photocopy the pattern to use as a template. Use screws with head sizes small enough to fit in the center of each of the four holes but large enough not to pop out of the elongated sections. Leave $1/8$ " of the screw shanks behind the heads sticking out of the wall.

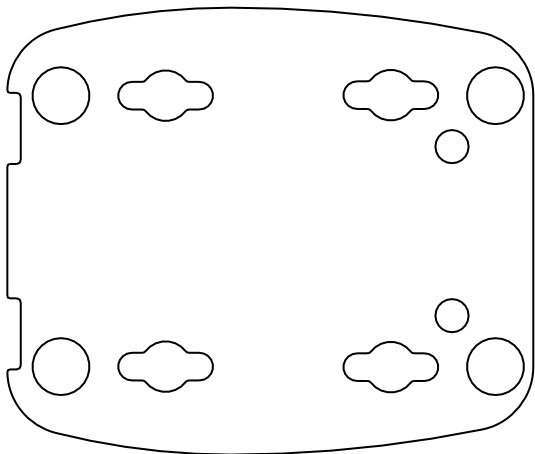

Photocopy this diagram of the screw-locator pattern on the bottom of your XM Antenna to use as a template for wall attachment.

3. Tilt the antenna fully back on the base. Place the antenna base on the four screw heads with the antenna pivot at the top and pull down approximately 1/4" until the base is firmly secured. Note that the XM logo will be upside down when the antenna is properly installed.
4. Tilt the antenna away from the wall/base until the signal is optimized.

Note: DO NOT CUT THE ANTENNA CABLE and attempt to splice it or attach alternative connectors or cable. The cable and connectors used in your Delphi Premium Sound System are specially chosen and attached at the factory to ensure that they will work with XM's unique frequency band. Use an XM-approved extension kit (Delphi model number SA10006) with your receiver.

Repeater Antenna

The Delphi Premium Sound System comes with a repeater antenna bracket. This bracket can be attached to base of the unit using the two screws provided with the bracket. Once the bracket is attached to the audio system, the repeater antenna can be snapped in place and the wire can be routed through the opening provided in the rear under the top cover. Plug the antenna into the connector and secure the access wire to the cover. The top cover can now be snapped in place.

Once the Delphi Premium Sound System is set up and the satellite receiver is installed, the complete setup can be controlled as described in the receiver's operating guide.

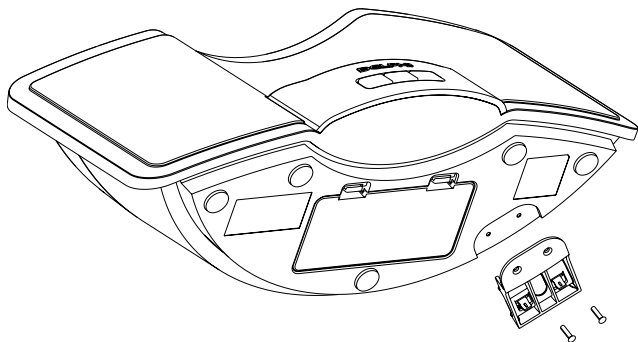

Unique Delphi Premium Sound System features include the following:

Volume

Volume can be adjusted using the push buttons on the Delphi Premium Sound System. In addition, when the receiver is connected to the Delphi Premium Sound System, the + and - controls on the receiver's remote control can also be used to increase (+) and decrease (-) volume.

DELPHI

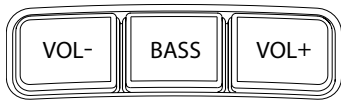

Note that the "Line Out Level" cannot be reset while the receiver is in the Delphi Premium Sound System. The volume control should be used to control the audio output instead. If the line out setting is adjusted while in a car cradle or home stand and the receiver is later reconnected to the Delphi Premium Sound System, it will automatically return to the prior setting the next time it is used in a vehicle adaptor or home adaptor.

Bass Boost

Delphi Premium Sound System is equipped with Maxx Bass technology. To turn on the additional bass press the BASS Boost (see illustration at left).

Additional Bass & Treble adjustment in the satellite radio: If your attached satellite radio has built-in EQ settings, bass and treble can be adjusted by pressing the “Menu” button, selecting “Bass + Treble,” and then setting them in the same manner as other menu functions.

This feature only appears and only applies when the receiver is seated in the Delphi Premium Sound System. If the receiver is removed and used in a vehicle adaptor or home adaptor, the bass and treble settings out of the receiver will be “flat” or “zero” since the audio signal will be processed by the vehicle or home audio systems. When the receiver is returned to the Delphi Premium Sound System, it will return to the previously used bass and treble settings.

Headphones

The Delphi Premium Sound System has a headphone jack located in the rear of the unit. Many popular styles and types of headphones or earbuds can be used as long as their plugs and/or adaptors fit the industry standard 3.5 mm diameter stereo jack.



Warning: Hearing damage from loud noise is almost undetectable until it is too late. Your hearing can adapt to higher volumes of

sound. Sound that seems normal can be loud and harmful to your hearing. Take precautions by adjusting the volume control on your audio system to a safe sound level before your hearing adapts to it.

To help avoid hearing loss or damage, do the following:

1. Adjust the volume control to the lowest setting.
2. Increase volume slowly until you hear comfortably and clearly.

Aux Input

To plug in your MP3 player, CD player, or other audio device, the Delphi Premium Sound System is equipped with an auxiliary 3.5 mm input jack located in the rear of the unit. Connection cables are not included.

Precautions

1. On power sources:

- For AC operation, it is recommended that only the supplied AC power adaptor is used.
- The satellite radio receiver should not be disconnected from the AC power source as long as it is connected to the wall outlet, even if the satellite radio receiver has been turned off or detached.
- Unplug the AC power adaptor from the wall outlet when it is not used for an extended period of time.
- For battery operation, use 8 "C" size batteries. Turn battery switch to off position to save battery power and protect batteries from draining during storage.
- The icon indicating operating voltage, power consumption, etc. is located next to the power jack on the rear cover.



Caution: When the batteries are not being used, remove them to avoid possible damage that can be caused by battery leakage or corrosion.

2. On placement:

- Do not place the Delphi Premium Sound System on an inclined or unstable surface.
- Do not place anything within 1/2" of the side of the Delphi Premium Sound System. The audio/ventilation ports must be unobstructed for the Delphi Premium Sound System to operate properly and prolong the life of its components.
- Since a strong magnet is used for the speakers, keep personal credit cards using magnetic coding or spring-wound watches away from the unit to prevent possible damage from the magnetic fields.

3. Do not immerse in water.

- This product is not meant to be immersed in water or come in continuous contact with water.
- Before opening or shutting the receiver cradle or battery compartment panel, be sure to wipe off water, dust, or sand on the outside of the unit.
- If the Delphi Premium Sound System is splashed with salt water, wipe clean with a damp cloth, and then dry with a soft dry cloth. Do not wash under running water; do not use soap or detergent; do not dry with an electric hair dryer.
- The supplied AC power adaptor is not water resistant. To prevent shock hazard, avoid using the Delphi Premium Sound System near water during AC operation.
- Water in the headphone jack, or Aux input jack, may cause rusting and possible malfunction.

Troubleshooting

If the power is not on:

- Connect the AC power adaptor to a wall outlet securely and make sure the wall outlet has 110V AC output.
- Make sure the batteries are inserted correctly.
- Replace all the batteries with new ones if they are weak.
- Make sure battery switch is turned to 'ON' position if attempting to operate on batteries.

If there is no audio:

- Unplug the satellite radio receiver from the Delphi Premium Sound System and re-insert it.
- Make sure that Audio level is set correctly.
- Make sure that radio is not muted.

If noise is heard coming through the Delphi Premium Sound System:

- Someone is using a portable telephone or other equipment that emits radio waves near the antenna (~2.3GHz). To solve this problem, move the portable telephone, etc. away from the unit.

Maintenance

To clean the cabinet panel and controls, use a soft cloth slightly moistened with a mild detergent solution. Do not use any type of abrasive pad, scouring powder, or solvent, such as alcohol or benzene.

Note: Unplug the AC power adaptor before cleaning to avoid any electric shock hazard.

Specifications

Frequency Response	30Hz to 20kHz
Headphone Connector Type	3.5mm Stereo Jack (1/8")
Auxiliary Connector Type.....	3.5mm Stereo Jack (1/8")
Battery Type/Qty	"C" Cell / 8 Total
Overall Dimensions	L15.7" x H7.8" x W8.3" (L400 x H198 x W210 mm)
Weight (Without Batteries).....	4.11 kg
Operating Temperatures	0° to 55° C (32° to 131° F)

Delphi Limited Consumer Warranty (United States)

Delphi Product and Service Solutions (“Delphi”) warrants all XM Satellite Radio Products sold by Delphi (each “Product”) to be free of defects in material and workmanship, subject to the following conditions:

The duration of Delphi’s warranty with respect to each Product is limited to one (1) year from the date of sale to the original consumer purchaser.

NO OTHER EXPRESS WARRANTIES ARE MADE WITH RESPECT TO ANY PRODUCT. ALL IMPLIED WARRANTIES, INCLUDING WARRANTIES OF MERCHANTABILITY AND FITNESS FOR A PARTICULAR PURPOSE ARE LIMITED TO THE WARRANTY PERIOD SET FORTH HEREIN. THIS WARRANTY IS NOT TRANSFERABLE AND APPLIES ONLY TO THE ORIGINAL CONSUMER PURCHASER OF THE PRODUCT.

Delphi will, as its sole obligation under this warranty, replace or repair, at its option, any Product that does not conform to this warranty. Products may be repaired or replaced with new or with refurbished items. This limited warranty does not cover defects in appearance, cosmetic or decorative items, including any non-operative parts. Under no circumstances will Delphi be liable for any incidental or consequential damages under this warranty or any implied warranties. These remedies are the customer’s exclusive remedies for breach of warranty. This limited warranty only extends to customers who purchase the Products in the United States.

Delphi will not be responsible for damage resulting from any (i) deviation of Delphi’s operating instructions as printed in Delphi’s catalog or on any packaging, labels or other literature provided with a Product, (ii)

installation of a Product in a manner which is inconsistent with Delphi's written instructions, (iii) alteration or modification of a Product, (iv) misuse, (v) neglect, (vi) abuse, (vii) accident, (viii) normal wear and tear, (ix) commercial use, (x) improper storage, (xi) environmental conditions, including excessive temperature or humidity, (xii) service by anyone other than a Delphi authorized repair facility, (xiii) other improper application, installation or operation of this Product, or (xiv) defects or malfunctions of which Delphi is not advised within ten (10) days of the expiration of the limited warranty period.

How you (the Customer) can get service

To obtain warranty service during the first thirty (30) days after the date of purchase, you must return the defective Product with the original receipt to the original place of purchase. To obtain warranty service during the first thirty (30) days for Products purchased from www.delphi.com and for all products for the remainder of the limited warranty period, you must contact Delphi by phone at 1.877.GO DELPHI (1.877.463.3574). If further clarification or additional information is required from Delphi, you may call Delphi at 1.877.GO DELPHI (1.877.463.3574).

If warranty service is needed at any time during the warranty period, the purchaser will be required to furnish a sales receipt/proof of purchase indicating the date of purchase, amount paid, and place of purchase. Customers who fail to provide such proof of purchase will be charged for the repair/replacement of any Product.

How state law relates to the warranty

Some states do not allow limitations on the duration of implied warranties, or the exclusion or the limitation of incidental or consequential damages. So the above limitations or exclusions may not apply to you. This warranty

gives you specific legal rights. You may also have other rights that may vary from state to state. NO PERSON IS AUTHORIZED BY DELPHI TO MODIFY OR ADD TO THIS LIMITED WARRANTY.

Delphi Limited Consumer Warranty (Canada)

Delphi Product and Service Solutions (“Delphi”) warrants all XM Satellite Radio Products sold by Delphi (each “Product”) to be free of defects in material and workmanship, subject to the following conditions:

The duration of Delphi’s warranty with respect to each Product is limited to one (1) year from the date of sale to the original consumer purchaser.

Delphi makes no express warranties with respect to any Product except as set forth herein. All implied conditions and warranties, including the implied conditions and warranties of merchantable quality and fitness for a particular purpose are limited to the warranty period set forth above. This warranty is not transferable and applies only to the original consumer purchaser of the Product.

Delphi will, as its sole obligation under this warranty, replace or repair, at its option, any Product that does not conform to this warranty. Products may be repaired or replaced with new or with refurbished items. This limited warranty does not cover defects in appearance, cosmetic or decorative items, including any non-operative parts. Under no circumstances will Delphi be liable for any loss of revenue, loss of profits or failure to realize expected savings (collectively, “Economic Loss”) under this warranty or any implied conditions or warranties. These remedies are the customer’s exclusive remedies for breach of conditions or warranty. This limited

warranty only extends to customers who purchase the Products in Canada.

Delphi will not be responsible for damage resulting from any (i) deviation of Delphi's operating instructions as printed in Delphi's catalog or on any packaging, labels or other literature provided with a Product, (ii) installation of a Product in a manner which is inconsistent with Delphi's written instructions, (iii) alteration or modification of a Product, (iv) misuse, (v) neglect, (vi) abuse, (vii) accident, (viii) normal wear and tear, (ix) commercial use, (x) improper storage, (xi) environmental conditions, including excessive temperature or humidity, (xii) service by anyone other than a Delphi authorized repair facility, (xiii) other improper application, installation or operation of this Product, or (xiv) defects or malfunctions of which Delphi is not advised within ten (10) days of the expiration of the limited warranty period.

How you (the Customer) can get service

To obtain warranty service during the first thirty (30) days after the date of purchase, you must return the defective Product with the original receipt to the original place of purchase. To obtain warranty service during the first thirty (30) days for Products purchased from www.delphi.com and for all Products for the remainder of the limited warranty period, you must contact Delphi by phone at 1.877.GO DELPHI (1.877.463.3574). If further clarification or additional information is required from Delphi, you may call Delphi at 1.877.GO DELPHI (1.877.463.3574).

If warranty service is needed at any time during the warranty period, the purchaser will be required to furnish a sales receipt/proof of purchase indicating the date of purchase, amount paid, and place of purchase. Customers who fail to provide such proof of purchase will be charged for the repair/replacement of any Product.

How provincial law relates to the warranty:

Some provinces do not allow limitations on the duration of implied conditions or warranties, or the exclusion or the limitation of Economic Loss. So the above limitations or exclusions may not apply to you. This warranty gives you specific legal rights. You may also have other rights that may vary from province to province. **NO PERSON IS AUTHORIZED BY DELPHI TO MODIFY OR ADD TO THIS LIMITED WARRANTY.**

DELPHI

Delphi Corporation
1441 West Long Lake Road
Troy, Michigan 48098-5090 U.S.A.
Customer Service: 1.877.GO.DELPHI

www.delphi.com

SKYFI®, Roady XT, The XM name, TuneSelect, and related logos are trademarks of XM Satellite Radio Inc.

Xpress by Audiovox is a trademark of the Audiovox Electronics Corporation.

MaxxBass and Maxx logo are registered trademarks of Waves Audio Ltd. in the United States and other countries.

MyFi is a trademark of Delphi Corporation.

©2007 Delphi Corporation. All rights reserved
DPSS-07-E-001 Version 1.0

ATTENTION:

Before you start, be sure to use the correct docking connector for your XM[®] receiver.



SKYFi3[®]

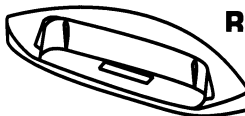

Rody[®] XT

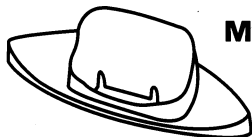

MyFi[®]



Audiovox[®]

See the enclosed user guide for complete instructions.

DELPHI

Delphi Premium Sound System

For special offers and to initiate your product warranty, register your Delphi Premium Sound System at

www.registerdelphi.com

For additional information on exciting accessories check your local retailer or visit www.shopdelphi.com



DELPHI

Expand Your Possibilities...

Delphi Premium Sound System



SKYFi3® Receiver and Car Kit (SA10224)

SKYFi3 is designed for the vehicle where most listening occurs, yet is completely portable for either stored XM® programming or MP3s. It mounts vertically or horizontally in your car and features an impressive 2.8-inch display for better visibility.

SKYFi3 Car Kit (SA10226)

The SKYFi3 Car Kit includes everything you need to add your SKYFi3 to an additional vehicle. It's easy to mount vertically or horizontally and features simple back-lit buttons.



SKYFi3 Home Kit (SA10227)

The SKYFi3 Home Kit includes everything you need to add your SKYFi3 to a home stereo.

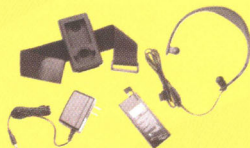

SKYFi3 Premium Wearable Kit (SA10252) (With Extra Battery SA10228)

Enjoy live XM radio on the go with these Wearable Live Kits. Extend your battery life with SA10228.

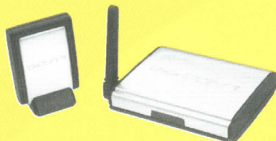

Delphi XM Signal Repeater (SA10116)

The Delphi XM Signal Repeater rebroadcasts the XM Satellite Radio signal throughout the home eliminating the need for long and unsightly antenna extensions. Through connection to any Delphi XM home kit or audio system, you can rebroadcast the XM signal up to 75 feet away, even through walls and floors.

Delphi XM 50' Extension Kit (SA10006)

Maximize your XM signal by increasing the length of your existing home antenna.

Buy today at www.shopdelphi.com!

SKYFi3[®]

Customers:

*We've recently added
new enhancements to
your SKYFi3 software!*



Go to <http://fwupdt.xmradio.com>
for the latest updates so that you
get optimum performance from
your SKYFi3 receiver.

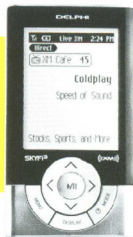

DELPHI

DIRECTIONS FOR UPDATING YOUR SKYFi3

- 1 Before you update your SKYFi3, be sure to remove your microSD card (if you have one) and make sure the unit is fully charged.
- 2 Go to a PC that is connected to the Internet. Get your SKYFi3 and the USB cable that was included in your original box. Don't connect to your PC yet.

Go to the XM Satellite Radio Firmware Upgrade site on the Internet at <http://fwupdt.xmradio.com>.
- 3 Click on "XM Firmware Update Client" below the product listing. A new window called the "File Download Security Warning" will appear. Click on "Run."
- 4 Another window will appear to tell you that your system is verifying the upgrade. It will verify the download. (Another window may appear, depending on your security settings. It will tell you that the publisher could not be verified. Simply click "Run" again and proceed.)
- 5 At this point, you will be instructed to connect the SKYFi3 to the computer via the USB that was enclosed with your new SKYFi3.

Remove your microSD card if you have one. Turn on the power for your SKYFi3 (be sure it is fully charged). Then click "Start."
- 6 The upgrade process takes only a few minutes. Watch the screen of the SKYFi3 to see when it is okay to disconnect your receiver. The prompt should read, "OK to Disconnect." Once you see that prompt, simply unplug and you're ready to go.