

SHARP®

SLIM-AUDIO-SYSTEM
MICRO SYSTÈME SLIM
SISTEMA MICRO DELGADO
TUNT MIKROSYSTEM
SISTEMA MICRO
SLIM MICRO SYSTEEM
SISTEMA MICRO SUPER LEVE
MICRO STEREO JÄRJESTELMÄ
SMUKŁA MIKROWIEŻA AUDIO
SLIM MICRO SYSTEM

MODELL
MODÈLE
MODELO
MODELL
MODELLO

MODEL
MODELO
MALLI
MODEL
MODEL

DK-KP95PH

BEDIENUNGSANLEITUNG
MODE D'EMPLOI
MANUAL DE MANEJO
BRUKSANVISNING

MANUALE DI ISTRUZIONI
GEBRUIKSAANWIJZING
MANUAL DE OPERAÇÃO

KÄYTTÖOHJE
INSTRUKCJA OBSŁUGI
OPERATION MANUAL

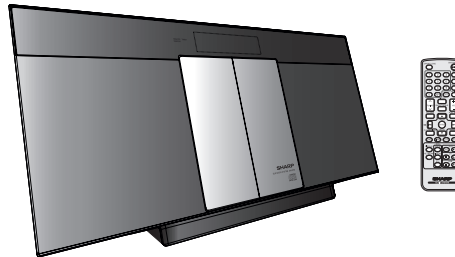

Made for



MP3



X-BASS



AirPlay, the AirPlay logo, iPad, iPhone, iPod, iPod classic, iPod nano, and iPod touch are trademarks of Apple Inc., registered in the U.S. and other countries.

DEUTSCH	...	Siehe Seiten i bis x und D-1 bis D-22.
FRANÇAIS	...	Se reporter aux pages i à x et F-1 à F-22.
ESPAÑOL	...	Consulte las páginas i a x y S-1 a S-22.
SVENSKA	...	Hänvisa till sidorna i till x och V-1 till V-22.
ITALIANO	...	Leggere le pagine i a x e I-1 a I-22.
NEDERLANDS	...	Raadpleeg de bladzijden i t/m x en N-1 t/m N-22.
PORTUGUÊS	...	Favor consultar as páginas i a x e P-1 a P-22.
SUOMI	...	Sivut i - x sekä SU-1 - SU-22.
POLSKI	...	Patrz strony od i do x oraz od 1 PL-1 do PL-22.
ENGLISH	...	Please refer to pages i to x and E-1 to E-22.

BESONDERE ANMERKUNGEN
REMARQUES SPÉCIALES
NOTAS ESPECIALES
SÄRSKILDA ANMÄRKNINGAR
NOTE PARTICOLARI
BIJZONDERE OPMERKINGEN
NOTAS ESPECIAIS
ERITYISHUOMAUTUS
WAŻNE INFORMACJE
SPECIAL NOTES



<ul style="list-style-type: none">● Hiermit erklärt SHARP Electronics (Europe) GmbH, dass sich das Gerät SHARP Slim-Audio-System DK-KP95PH in Übereinstimmung mit den grundlegenden Anforderungen und den übrigen einschlägigen Bestimmungen der Richtlinie 1999/5/EG befindet. Die Konformitätserklärung kann unter folgender Adresse gefunden werden: http://www.sharp.de/doc/DK-KP95PH.pdf● Für die Verwendung in Europa.● Dieses Produkt ist für den Betrieb im Innenbereich konzipiert.	<ul style="list-style-type: none">● Hierbij verklaart SHARP Electronics (Europe) GmbH dat het toestel SHARP Slim Micro Systeem DK-KP95PH in overeenstemming is met de essentiële eisen en de andere relevante bepalingen van richtlijn 1999/5/EG. De overeenstemmingsverklaring is beschikbaar op: http://www.sharp.de/doc/DK-KP95PH.pdf● Voor gebruik in Europa.● Dit product is alleen voor gebruik binnenshuis.
<ul style="list-style-type: none">● Par la présente, SHARP Electronics (Europe) GmbH déclare que l'appareil SHARP Micro Système Slim DK-KP95PH est conforme aux exigences essentielles et aux autres dispositions pertinentes de la directive 1999/5/CE. La déclaration de conformité peut être consultée sur le site: http://www.sharp.de/doc/DK-KP95PH.pdf● Compatible avec une utilisation en Europe.● Ce produit n'est conçu que pour une utilisation en intérieur.	<ul style="list-style-type: none">● Eu, SHARP Electronics (Europe) GmbH, declaro que o SHARP Sistema Micro Super Leve DK-KP95PH cumpre os requisitos essenciais e outras provisões relevantes da Directiva 1999/5/EC. A Declaração de conformidade pod ser consultada em: http://www.sharp.de/doc/DK-KP95PH.pdf● Para uso na Europa.● Este produto destina-se a ser usado apenas dentro de casa.
<ul style="list-style-type: none">● Por la presente, SHARP Electronics (Europe) GmbH, declara que este SHARP Sistema Micro Delgado DK-KP95PH cumple con los requisitos esenciales y otras exigencias relevantes de la Directiva 1999/5/EC Pueden consultar la declaración de conformidad en: http://www.sharp.de/doc/DK-KP95PH.pdf● Para su uso en Europa.● Este producto es para su uso en interiores solamente.	<ul style="list-style-type: none">● SHARP Electronics (Europe) GmbH vakuuttaa täten että SHARP Micro Stereo Järjestelmä DK-KP95PH tyyppinen laite on direktiivin 1999/5/EY oleellisten vaatimusten ja sitä koskevien direktiivin muiden ehtojen mukainen. Vakuutus on nähtävissä osoitteessa: http://www.sharp.de/doc/DK-KP95PH.pdf● Käytettäväksi Euroopassa.● Laite sopii käytettäväksi vain sisätiloissa.
<ul style="list-style-type: none">● Härmed intygar SHARP Electronics (Europe) GmbH att denna SHARP Tunst Mikrosystem DK-KP95PH står i överensstämmelse med de väsentliga egenskapskrav och övriga relevanta bestämmelser som framgår av direktiv 1999/5/EG. Deklaration om överensstämmelse är tillgänglig på web adressen: http://www.sharp.de/doc/DK-KP95PH.pdf● För användning i Europa.● Denna produkt är endast avsedd för inomhusbruk.	<ul style="list-style-type: none">● Niniejszym SHARP Electronics (Europe) GmbH deklaruje, że Smukła Mikrowieża Audio SHARP DK-KP95PH jest zgodny z zasadniczymi wymaganiami i innymi właściwymi postanowieniami Dyrektywy 1999/5/EC. Deklaracja zgodności jest dostępna pod adresem: http://www.sharp.de/doc/DK-KP95PH.pdf● Wylącznie na rynek europejski.● Produkt przeznaczony wyłącznie do eksploatacji w pomieszczeniach.
<ul style="list-style-type: none">● Con la presente SHARP Electronics (Europe) GmbH dichiara che questo SHARP Sistema Micro DK-KP95PH è conforme ai requisiti essenziali ed alle altre disposizioni pertinenti stabilite dalla direttiva 1999/5/CE. La dichiarazione di conformità può essere consultata sul sito: http://www.sharp.de/doc/DK-KP95PH.pdf● Dichiarazione di conformità La società SHARP Electronics (Europe) GmbH dichiara che il prodotto SHARP Sistema Micro DK-KP95PH è costruito in conformità alle prescrizioni del D.M.no 548 del 28/8/95, pubblicato sulla G.U.no 301 del 28/12/95 ed in particolare è conforme a quanto indicato nell'art. 2, comma 1 dello stesso decreto.● Solo per l'Europa.● Questo prodotto è adatto solo per l'utilizzo in interno.	<ul style="list-style-type: none">● Hereby, SHARP Electronics (Europe) GmbH declares that this SHARP Slim Micro System DK-KP95PH is in compliance with the essential requirements and other relevant provisions of Directive 1999/5/EC. The declaration of conformity may be consulted at: http://www.sharp.de/doc/DK-KP95PH.pdf● For use in Europe.● This product is for indoor use only.

<ul style="list-style-type: none"> ● Bei Einstellung der ON/STAND-BY-Taste auf STAND-BY ist die Netzspannung immer noch im Gerät vorhanden. Wenn die ON/STAND-BY-Taste auf STAND-BY eingestellt wird, kann das Gerät unter Verwendung der Timer-Betriebsart oder Fernbedienung in Betrieb gesetzt werden. Warnung: In diesem Gerät sind keine vom Benutzer wartbaren Teile vorhanden. Niemals Abdeckungen entfernen, außer wenn Sie dafür qualifiziert sind. In diesem Gerät sind gefährliche Spannungen vorhanden. Vor Ausführung von irgendwelchen Kundendienstarbeiten oder bei längerer Nichtverwendung des Gerätes stets den Netzstecker aus der Netzsteckdose ziehen. 	<ul style="list-style-type: none"> ● Wanneer de ON/STAND-BY toets in de STAND-BY stand staat, loopt er nog steeds stroom (netspanning) in het toestel. Wanneer de ON/STAND-BY toets in de STAND-BY stand staat, kan het toestel ingeschakeld worden via de timerfunctie of de afstandsbediening. Waarschuwing: Dit toestel bevat geen door de gebruiker te repareren onderdelen. Verwijder de behuizing nooit tenzij u deskundig bent op dit gebied. In het toestel loopt een gevaarlijke spanning; haal de stekker altijd uit het stopcontact alvorens onderhoud uit te voeren of wanneer het toestel voor langere tijd niet gebruikt wordt.
<ul style="list-style-type: none"> ● Lorsque la touche ON/STAND-BY est mise en STAND-BY, l'appareil est toujours sous tension. Lorsque la touche ON/STAND-BY se trouve sur la position STAND-BY, l'appareil est prêt à fonctionner par la minuterie ou la télécommande. Avvertissement: Cet appareil contient des pièces non réparables par l'utilisateur. Personne non qualifiée n'enlèvera jamais les couvercles. L'appareil contenant des organes portés à haute tension, débrancher l'appareil avant toute réparation ou en période de non-utilisation. 	<ul style="list-style-type: none"> ● Quando o botão ON/STAND-BY estiver ajustado na posição STAND-BY, a voltagem de alimentação ainda se encontra presente dentro do aparelho. Quando o botão ON/STAND-BY estiver ajustado na posição STAND-BY, o aparelho pode ser colocado em operação através do modo de programação horária ou pelo controle remoto. Advertência: Neste aparelho não há partes que podem ser consertadas pelo usuário. Nunca retire a tampa, a menos que você tenha qualificação para tal. Este aparelho contém voltagens perigosas. Remova sempre o cabo de alimentação da tomada antes de efetuar qualquer conserto ou quando deixar o aparelho muito tempo fora de uso.
<ul style="list-style-type: none"> ● Cuando el botón ON/STAND-BY está puesto en la posición STAND-BY, todavía hay tensión dentro del aparato. Cuando el botón ON/STAND-BY está puesto en la posición STAND-BY, el aparato puede ponerse en funcionamiento utilizando el modo del temporizador o el controlador remoto. Advertencia: Tenga en cuenta que dentro de este aparato no hay piezas que pueda reparar. No quite nunca las tapas a menos que se esté cualificado para hacerlo. Este aparato tiene en su interior tensiones peligrosas. Desenchufe siempre la clavija de la red del tomacorriente antes de realizar cualquier servicio de mantenimiento y cuando no se use el aparato durante un largo periodo de tiempo. 	<ul style="list-style-type: none"> ● Kun ON/STAND-BY -kytkin on STAND-BY-asennossa, laitteessa on yhä virta. Kun ON/STAND-BY -kytkin on STAND-BY-asennossa, laite voidaan kytkeä päälle kaukosäätimestä. Varoitus: Laitteen sisällä ei ole käyttäjän huollettavissa olevia osia. Kotelon saa irrottaa vain siihen pätevyitynyt henkilö. Laitteen sisällä on vaarallinen jännite. Laite on aina irrottettava verkkovirrasta ennen huoltotoimenpiteitä ja jos laite on pitkään käyttämättä.
<ul style="list-style-type: none"> ● När ON/STAND-BY knappen är i läge STAND-BY, finns nätspänning i apparaten. Med ON/STAND-BY knappen i läge STAND-BY kan apparaten startas med timerfunktion eller fjärrkontrollen. Varning: Apparaten innehåller inga delar som kan åtgärdas av kunden. Höljet får endast öppnas av kvalificerad personal. Apparaten innehåller farliga spänningar. Stickkontakten ska därför dras ut från nätuttaget före reparationsarbeten och bör dras ut om apparaten inte ska användas på mycket länge. 	<ul style="list-style-type: none"> ● Gdy urządzenie znajduje się w trybie czuwania, jego wewnętrzne elementy są pod napięciem. Gdy urządzenie znajduje się w trybie czuwania, może zostać włączone przy pomocy zegara lub pilota. Ostrzeżenie: Wewnętrzny urządzenia nie ma żadnych elementów wymagających obsługi użytkownika. Obudowa może być zdejmowana wyłącznie przez wykwalifikowanych pracowników serwisu. Wewnętrzne elementy urządzenia znajdują się pod napięciem. Przed zdjeciem odbudowy, lub gdy urządzenie ma zostać przez dłuższy czas nieużywane, należy wyjąć wtyczkę z gniazdka elektrycznego.
<ul style="list-style-type: none"> ● Quando il tasto ON/STAND-BY si trova in posizione STAND-BY, all'interno dell'apparecchio c'è ancora la corrente. Se il tasto ON/STAND-BY si trova nella posizione STAND-BY, l'unità può essere accesa con il modo timer o con il telecomando. Avvertenza: L'apparecchio non contiene parti riparabili dall'utente. Non togliere mai i coperchi, a meno di non essere qualificati per farlo. All'interno dell'apparecchio ci sono tensioni pericolose, per cui si deve sempre staccare la spina del cavo d'alimentazione dalla presa di corrente prima di qualsiasi intervento di manutenzione e quando non si usa l'apparecchio per un lungo periodo di tempo. 	<ul style="list-style-type: none"> ● When the ON/STAND-BY button is set at STAND-BY position, mains voltage is still present inside the unit. When the ON/STAND-BY button is set at STAND-BY position, the unit may be brought into operation by the timer mode or remote control. Warning: This unit contains no user serviceable parts. Never remove covers unless qualified to do so. This unit contains dangerous voltages, always remove mains plug from the socket before any service operation and when not in use for a long period.
	<ul style="list-style-type: none"> ● När ON/STAND-BY-knappen er sat i STAND-BY positionen, er der stadig netspænding til stede i apparatet. Når ON/STAND-BY-knappen er sat i STAND-BY position, kan apparatet startes v.h.j.a. timer-funktionen eller fjernbetjeningen. Advarsel: Apparatet indeholder ingen dele, der kan repareres af brugeren selv. Fjern aldrig kabinettet med mindre De er kvalificeret hertil. Apparatet indeholder farlig strømspænding. Traek altid stikket ud af stikkontakten før der foretages reparationer, eller hvis apparatet ikke er i brug i længere tid.

PŘED SEJMUTÍM KRYTU NUTNO VYJMOUT VIDLICI ZE SÍŤOVÉ ZÁSUVKY.

PRED ZLOŽENÍM KRYTU JE NUTNÉ ODPOJIŤ PŘÍSTROJ ZO SIETE.

DENNA APPARAT ÄR ANSLUTEN TILL 230 V VÄXELSTRÖM NÄR STICKPROPPEN ÄR INSKJUTEN I VÄGGUTTAGET. FÖR ATT FULLSTÄNDIGT KOPPLA IFRÅN APPARATEN, V.G. DRAG UT STICKPROPPEN.

- Audio-visuelles Material kann Urheberrechte umfassen, die ohne Genehmigung des Eigentümers dieser Urheberrechte nicht aufgenommen werden dürfen. Siehe die entsprechenden nationalen Gesetze.
- Le matériel audio-visuel peut comporter des oeuvres faisant l'objet de droits d'auteur qui ne peuvent être enregistrées sans l'autorisation du possesseur du droit d'auteur, veuillez vous référer aux réglementations nationales en vigueur.
- El material audiovisual puede consistir en trabajos que tengan derechos de autor y que no deben grabarse sin la autorización del poseedor de dichos derechos de autor. Sírvase consultar las leyes aplicables en su país.
- Audiovisuellt material kan innehålla upphovsrättsarbete som inte skall mångfaldigas utan tillstånd av copyrightinnehavaren. Se den tillämpliga lagen i ditt land.
- Il materiale audio-visivo che fosse soggetto a copyright non può essere registrato senza l'autorizzazione del possessore del copyright. Si prega di attenersi alle leggi in vigore sul territorio nazionale.
- Audio-visueel materiaal kan worden beschermd door auteursrechten, in welk geval het niet mag worden opgenomen zonder de toestemming van de auteursrechthouder. Zie voor nadere informatie de betreffende wetten in het land van gebruik.
- O material audiovisual pode consistir de trabalhos de direitos autorias que não devem ser gravados sem autorização do proprietário dos direitos. Favor consultar as leis vigentes em seu país.
- Audiovisuaalinen materiaali saattaa olla tekijänoikeudella suojattua, eikä sitä tällöin saa tallentaa ilman tekijänoikeuden haltijan lupaa. Lisätietoja on maassasi sovellettavassa tekijänoikeuslaissa.
- Materiał audiowizualny może zawierać utwory chronione prawem autorskim, które nie mogą być nagrywane bez zgody właściciela praw autorskich. Patrz odpowiednie regulacje prawne w danym kraju
- Audio-visual material may consist of copyrighted works which must not be recorded without the authority of the owner of the copyright. Please refer to relevant law in your country.

● **Vorsicht:**
Das Gerät weder Tropf- noch Spritzwasser aussetzen. Ansonsten besteht die Gefahr eines Brandes oder elektrischen Schlages. Es dürfen keine mit Flüssigkeiten gefüllten Gegenstände wie Vasen auf dem Gerät abgestellt werden.

● **Attention:**
Pour éviter un incendie ou une secousse électrique, mettre l'appareil à l'abri de l'eau (éclaboussure, goutte). Ne pas poser sur l'appareil un récipient contenant du liquide.

● **Advertencia:**
Para evitar incendios y descargas eléctricas, no exponga el aparato a goteo o salpicadura de líquidos. No deberán ponerse encima del aparato objetos que estén llenos de líquido, como por ejemplo un florero.

● **Varning:**
Utsätt inte enheten för dropp eller stänk för att förhindra brand eller elektriska stötter. Inga vätskefyllda föremål såsom vasor får placeras på enheten.

● **Attenzione:**
Per prevenire incendi o scosse elettriche, non fare gocciolare nessun liquido sull'apparecchio e non bagnarlo. Non collocarvi sopra nessun oggetto riempito d'acqua, come per esempio vasi.

● **Waarschuwing:**
Stel het toestel niet bloot aan druipend of spattend water om brand en elektrische schokken te voorkomen. Met vloeistoffen gevulde voorwerpen, zoals vazen, mogen niet op het toestel geplaatst worden.

● **Cuidado:**
Para evitar incêndio ou choque elétrico, não exponha este aparelho a gotejamento ou salpicamento de água. Não coloque objetos com água como, por exemplo, um vaso de flores, em cima do aparelho.

● **Varoitus:**
Tulipalon tai sähköiskun välttämiseksi laitetta ei saa altistaa tippuvalle tai roiskuvalle vedelle. Nestettä sisältäviä astioita kuten esim kukkamaljakoita ei saa asettaa laitteen päälle.

● **Ostrzeżenie:**
Żeby zapobiec niebezpieczeństwu pożaru lub porażeniu prądem, urządzenie należy chronić przed zalaniem lub wilgocią. Na urządzeniu nie wolno ustawiać żadnych zbiorników z wodą - np. wazonów.

● **Warning:**
To prevent fire or shock hazard, do not expose this appliance to dripping or splashing. No objects filled with liquids, such as vases, shall be placed on the apparatus.

<ul style="list-style-type: none"> ● Advarsel: Til at forbygge ild og stød risiko, lad vaere med at undsaette denne indretning for drypning eller overstaenkning. Der må ikke anbringes nogen genstande fyldt med vand, som for eksempel vaser, på dette apparat.
<ul style="list-style-type: none"> ● Advarsel: For å unngå brann eller kortslutning, utsett ikke produktet for vann eller fuktighet. Gjenstander som inneholder væske, f.eks. en blomstervase, må ikke plasseres oppå apparatet.
<ul style="list-style-type: none"> ● Varoitus: Älä vie laitetta sateeseen tai kosteisiin tiloihin. Jos laite on kostunut, anna sen kuivua ennen kuin käytät sitä verkkovirralla. Nestettä sisältäviä astioita kuten esim. kukkamaljakoita ei saa asettaa laitteen päälle.

<p>PŘÍSTROJ NEVYSTAVUJTE KAPAJÍCÍ NEBO STRÍKAJÍCÍ VODĚ.</p> <p>PRÍSTROJ NEVYSTAVUJTE KVAPKAJÚCEJ ALEBO STRIEKAJÚCEJ VODE.</p> <p>Urządzenie należy chronić przed zalaniem i wilgocią.</p>
--

<ul style="list-style-type: none"> ● Dieses Produkt ist ein Laserprodukt der Klasse 1. ● Ce produit est classifié comme étant un LASER DE CLASSE 1. ● Este producto está clasificado como un PRODUCTO LÁSER DE CLASE 1. ● Denna produkt klassificeras som KLASS 1 LASERPRODUKT. ● Questo prodotto è classificato come CLASS 1 LASER PRODUCT. ● Dit product is geclassificeerd als een KLASSE 1 LASER PRODUCT. ● Este produto é classificado como PRODUTO LASER DE CLASSE 1. ● Tämä laite on luokiteltu LUOKAN 1 LASERLAITTEEKSI. ● Opiswane urządzenie jest sklasyfikowane jako PRODUKT LASEROWY KLASY 1. ● This product is classified as a CLASS 1 LASER PRODUCT.
--

<ul style="list-style-type: none"> ● Dette produktet er klassifisert som et KLASSE 1 LASERPRODUKT. ● Dette produkt er klassifiseret som et KLASSE 1 LASERPRODUKT. ● Tämä laite on luokiteltu LUOKAN 1 LASERLAITTEEKSI. ● Denna produkt klassificeras som KLASS 1 LASERAPPARAT. ● Tento výrobek je klasifikován jako LASEROVÝ VÝROBEK TŘÍDY 1. ● Tento výrobek je klasifikovaný ako LASEROVÝ VÝROBOK TRIEDY 1.

<ul style="list-style-type: none"> ● VORSICHT Dieses Gerät enthält Laser-Gerät geringer Leistung. Um nachhaltige Sicherheit zu gewährleisten entfernen Sie kein Gehäuse und versuchen Sie nicht Zugang zum Inneren des Produktes zu erhalten. Wenden Sie sich bei auftretenden Servicefällen immer an Fachpersonal.
<ul style="list-style-type: none"> ● ATTENTION Ce produit contient un dispositif laser de puissance inférieure. Pour assurer une sécurité continue ne retirez pas le cache et n'essayez pas d'accéder l'intérieur du produit. Tout entretien doit être fait par du personnel qualifié.
<ul style="list-style-type: none"> ● PRECAUCIÓN Este producto contiene un dispositivo láser de potencia más baja. Para garantizar una continua seguridad, no retire ninguna cubierta ni intente acceder al interior del producto. Solicite el servicio de personal cualificado.
<ul style="list-style-type: none"> ● OBSERVERA Denna produkt innehåller en svagströmslaser. För att säkerställa fortsatt säkerhet ta inte bort något hölje eller försök få tillgång till insidan av produkten. Överlat alla servicearbeten åt kvalificerad personal.
<ul style="list-style-type: none"> ● ATTENZIONE Questo prodotto contiene un dispositivo laser a bassa potenza. Per garantire una sicurezza continua, non togliete alcuna protezione e non cercate di accedere all'interno del prodotto. Fate sempre riferimento ad un personale qualificato.
<ul style="list-style-type: none"> ● LET OP Dit product bevat een Lagervermogen-laser apparaat. Om een voortdurende veiligheid te waarborgen verwijder geen enkele beschermkap of probeer toegang te krijgen tot het binnenste van het apparaat. Laat alle reparaties over aan bevoegd personeel.
<ul style="list-style-type: none"> ● CUIDADO Este produto contém um dispositivo laser de baixa potencia. Para assegurar uma segurança contínua não remova nenhuma capa nem tente aceder ao interior do produto. Remeta todo o tipo de manutenção para pessoal qualificado.
<ul style="list-style-type: none"> ● VAROITUS Tämä tuote sisältää laser-juovapyyhkäyslaitteen. Varmistaakseen turvallisuutta älä poista kantta äläkä yritä korjata laitetta itse. Jätä huolto pätevän huoltohenkilön tehtäväksi.
<ul style="list-style-type: none"> ● OSTRZEŽENIE Ten produkt zawiera urządzenie laserowe małej mocy. Żeby nie narażać na niebezpieczeństwo osób znajdujących się w pobliżu, nie wolno demontować żadnych elementów obudowy ani próbować dostać się do wnętrza produktu. Wszelkie naprawy należy zlecać wykwalifikowanym pracownikom serwisu.
<ul style="list-style-type: none"> ● CAUTION This product contains a lower power laser device. To ensure continued safety do not remove any cover or attempt to gain access to the inside of the product. Refer all servicing to qualified personnel.

VÝSTRAHA: VÝROBEK JE VYBAVEN LASEREM. PŘI NESPRÁVNÉ MANIPULACI S PŘÍSTROJEM V ROZPORU S TÝMTO NÁVODEM MŮŽE DOJÍT K NEBEZPEČNÉMU OZÁŘENÍ. NEOTVÍREJTE A NESNÍMEJTE PROTO ŽÁDNÉ KRYTY A PŘÍSTROJ NEOPRAVUJTE. OPRAVU A SERVIS SVĚŘTE ODBORNÉMU SERVISU.

VÝSTRAHA: VÝROBEK JE VYBAVENÝ LASEROM. PRI NESPRÁVNOM MANIPULOVANÍ S PŘÍSTROJOM V ROZPORE S TÝMTO NÁVODOM MŮŽE DÔJŠŤ K NEBEZPEČNÉMU OŽIARENÍU. NEODKRÝVAJTE PRETO ŽIADNE KRYTY A PŘÍSTROJ NEOPRAVUJTE OPRAVU A SERVIS PRENEHAJTE ODBORNÉMU SERVISU.

„Made for iPod“, „Made for iPhone“ und „Made for iPad“ bedeutet, dass ein elektronisches Zubehörteil speziell für den Anschluss an einen iPod, iPhone oder iPad konzipiert wurde und der Entwickler sich dafür verbürgt, dass das Gerät den Leistungsstandards von Apple entspricht. Apple ist nicht verantwortlich für den Betrieb dieses Gerätes oder dafür, dass es Sicherheits- und Regulierungsstandards einhält. Bitte beachten Sie, dass die Nutzung dieses Zubehörteils mit einem iPod oder iPhone zu einer Beeinträchtigung der drahtlosen Leistung führen kann.

Les termes « Made for iPod », « Made for iPhone » et « Made for iPad » indiquent qu'un accessoire électronique a été spécifiquement conçu pour se raccorder respectivement à un iPod, iPhone ou iPad, et satisfait, sous certification du développeur, aux normes de performance d'Apple. Apple n'est pas responsable de l'emploi de cet appareil ni de sa conformité aux normes réglementaires et de sécurité. Veuillez noter que l'utilisation de cet accessoire avec l'iPod ou l'iPhone peut affecter les performances sans fil.

“Made for iPod”, “Made for iPhone” y “Made for iPad” significa que se ha diseñado un accesorio electrónico para conectar específicamente al iPod, iPhone o iPad, respectivamente, y el fabricante ha certificado que cumple con las normas de desempeño de Apple. Apple no se responsabiliza por el funcionamiento de este dispositivo ni por su cumplimiento con las normas de seguridad y regulatorias. Tenga en cuenta que el uso de este accesorio con el iPod o el iPhone puede afectar el funcionamiento del inalámbrico.

“Made for iPod”, “Made for iPhone” och “Made for iPad” innebär att ett elektroniskt tillbehör har designats för att kopplas specifikt till en iPod, iPhone eller iPad och har certifierats av utvecklaren för att tillfredsställa Apples prestandanormer. Apple ansvarar inte för användning av denna apparat eller dess överensstämmelse med säkerhetsnormer och föreskrifter. Observera att användning av detta tillbehör med iPod eller iPhone kan påverka den trådlösa prestandan.

“Made for iPod”, “Made for iPhone” e “Made for iPad” significano che un accessorio elettronico è stato progettato per essere specificamente collegato iPod, iPhone o iPad, rispettivamente; inoltre, il produttore ne ha certificato la conformità agli standard di funzionamento Apple. Apple non si ritiene responsabile circa il funzionamento del presente dispositivo o la sua conformità con gli standard normativi e relativi alla sicurezza. L'utilizzo di questo accessorio con iPod o iPhone potrebbe influire sulle prestazioni wireless.

“Made for iPod”, “Made for iPhone” en “Made for iPad” beteknet dat een elektronische accessoire ontworpen is om specifiek aangesloten te worden op de iPod, iPhone of iPad respectievelijk en gecertificeerd is door de ontwerper om aan de Apple prestatie maatstaven te voldoen. Apple is niet verantwoordelijk voor de werking van dit apparaat of zijn naleving aan veiligheids- en regelgevende maatstaven. Realiseer u, dat het gebruik van dit accessoire een negatieve invloed kan hebben op draadloos gebruik van uw iPod of iPhone.

A indicação “Made for iPod”, “Made for iPhone” e “Made for iPad” significa que um acessório eletrônico foi concebido para se ligar especificamente ao iPod, iPhone ou iPad, respectivamente, e foi certificado pelo fabricante para satisfazer os padrões de desempenho da Apple. A Apple não é responsável pelo funcionamento deste aparelho ou pelo cumprimento das normas de segurança e regulamentares. De salientar que o uso deste acessório com o iPod ou iPhone pode afectar o desempenho sem fios.

“Made for iPod”, “Made for iPhone” ja “Made for iPad” tarkoittavat sitä, että elektroninen lisälaitte on suunniteltu nimenomaisesti iPod, iPhone tai iPad. Valmistaja on sertifioinut laitteen niin, että se vastaa Applen standardeja. Apple ei ole vastuussa laitteen toiminnasta tai sen yhdenmukaisuudesta turvallisuus- ja sääntelystandardien kanssa. Huomaa, että tämän lisälaitteen käyttö iPodin tai iPhoneen kanssa saattaa vaikuttaa langattoman verkon toimintaan.

Oznaczenia “Made for iPod,” “Made for iPhone,” oraz “Made for iPad” oznaczają, że dane wyposażenie zostało zaprojektowane specjalnie do współpracy z urządzeniem iPod, iPhone lub iPad i posiadają certyfikat producenta na zgodność z normami firmy Apple. Firma Apple nie ponosi odpowiedzialności za działanie tego wyposażenia ani jego zgodności z normami dotyczącymi bezpieczeństwa i innymi przepisami. Należy pamiętać o tym, że użytkowanie niniejszego zestawu z urządzeniem iPod, iPhone lub iPad może niekorzystnie oddziaływać na łączność bezprzewodową.

“Made for iPod,” “Made for iPhone,” and “Made for iPad” mean that an electronic accessory has been designed to connect specifically to iPod, iPhone, or iPad, respectively, and has been certified by the developer to meet Apple performance standards. Apple is not responsible for the operation of this device or its compliance with safety and regulatory standards. Please note that the use of this accessory with iPod, iPhone, or iPad may affect wireless performance.

Entsorgungsinformationen



Achtung: Ihr Produkt trägt dieses Symbol. Es besagt, dass Elektro- und Elektronikgeräte nicht mit dem Haushaltsmüll entsorgt, sondern einem getrennten Rücknahmesystem zugeführt werden sollten.

A. Informationsinformationen für Benutzer aus Privathaushalten

1. In der Europäischen Union

Achtung: Werfen Sie dieses Gerät zur Entsorgung bitte nicht in den normalen Hausmüll!

Gemäß einer neuen EU-Richtlinie, die die ordnungsgemäße Rücknahme, Behandlung und Verwertung von gebrauchten Elektro- und Elektronikgeräten vorschreibt, müssen elektrische und elektronische Altgeräte getrennt entsorgt werden.

Nach der Einführung der Richtlinie in den EU-Mitgliedstaaten können Privathaushalte ihre gebrauchten Elektro- und Elektronikgeräte nun kostenlos an ausgewiesenen Rücknahmestellen abgeben*.

In einigen Ländern* können Sie Altgeräte u.U. auch kostenlos bei Ihrem Fachhändler abgeben, wenn Sie ein vergleichbares neues Gerät kaufen. *) Weitere Einzelheiten erhalten Sie von Ihrer Gemeindeverwaltung.

Wenn Ihre gebrauchten Elektro- und Elektronikgeräte Batterien oder Akkus enthalten, sollten diese vorher entnommen und gemäß örtlich geltenden Regelungen getrennt entsorgt werden.

Durch die ordnungsgemäße Entsorgung tragen Sie dazu bei, dass Altgeräte angemessen gesammelt, behandelt und verwertet werden. Dies verhindert mögliche schädliche Auswirkungen auf Umwelt und Gesundheit durch unsachgemäße Entsorgung.

2. In anderen Ländern außerhalb der EU

Bitte erkundigen Sie sich bei Ihrer Gemeindeverwaltung nach dem ordnungsgemäßen Verfahren zur Entsorgung dieses Geräts. Für die Schweiz: Gebrauchte Elektro- und Elektronikgeräte können kostenlos beim Händler abgegeben werden, auch wenn Sie kein neues Produkt kaufen. Weitere Rücknahmesysteme finden Sie auf der Homepage von www.swico.ch oder www.sens.ch.

B. Entsorgungsinformationen für gewerbliche Nutzer

1. In der Europäischen Union

Wenn Sie dieses Produkt für gewerbliche Zwecke genutzt haben und nun entsorgen möchten:

Bitte wenden Sie sich an Ihren SHARP Fachhändler, der Sie über die Rücknahme des Produkts informieren kann. Möglicherweise müssen Sie die Kosten für die Rücknahme und Verwertung tragen. Kleine Produkte (und kleine Mengen) können möglicherweise bei Ihrer örtlichen Rücknahmestelle abgegeben werden.

Für Spanien: Bitte wenden Sie sich an das vorhandene Rücknahmesystem oder Ihre Gemeindeverwaltung, wenn Sie Fragen zur Rücknahme Ihrer Altgeräte haben.

2. In anderen Ländern außerhalb der EU

Bitte erkundigen Sie sich bei Ihrer Gemeindeverwaltung nach dem ordnungsgemäßen Verfahren zur Entsorgung dieses Geräts.

Informations sur la mise au rebut correcte



Attention : votre produit comporte ce symbole. Il signifie que les produits électriques et électroniques usagés ne doivent pas être mélangés avec les déchets ménagers généraux. Un système de collecte séparé est prévu pour ces produits.

A. Informations sur la mise au rebut à l'intention des utilisateurs privés (ménages)

1. Au sein de l'Union européenne

Attention : si vous souhaitez mettre cet appareil au rebut, ne le jetez pas dans une poubelle ordinaire!

Les appareils électriques et électroniques usagés doivent être traités séparément et conformément aux lois en vigueur en matière de traitement, de récupération et de recyclage adéquats de ces appareils.

Suite à la mise en oeuvre de ces dispositions dans les Etats membres, les ménages résidant au sein de l'Union européenne peuvent désormais ramener gratuitement* leurs appareils électriques et électroniques usagés sur des sites de collecte désignés.

Dans certains pays*, votre détaillant reprendra également gratuitement votre ancien produit si vous achetez un produit neuf similaire.

*) Veuillez contacter votre administration locale pour plus de renseignements. Si votre appareil électrique ou électronique usagé comporte des piles ou des accumulateurs, veuillez les mettre séparément et préalablement au rebut conformément à la législation locale en vigueur.

En veillant à la mise au rebut correcte de ce produit, vous contribuerez à assurer le traitement, la récupération et le recyclage nécessaires de ces déchets, et préviendrez ainsi les effets néfastes potentiels de leur mauvaise gestion sur l'environnement et la santé humaine.

2. Pays hors de l'Union européenne

Si vous souhaitez mettre ce produit au rebut, veuillez contacter votre administration locale qui vous renseignera sur la méthode d'élimination correcte de cet appareil.

Suisse : les équipements électriques ou électroniques usagés peuvent être ramenés gratuitement au détaillant, même si vous n'achetez pas un nouvel appareil. Pour obtenir la liste des autres sites de collecte, veuillez vous reporter à la page d'accueil du site www.swico.ch ou www.sens.ch.

B. Informations sur la mise au rebut à l'intention des entreprises

1. Au sein de l'Union européenne

Si ce produit est utilisé dans le cadre des activités de votre entreprise et que vous souhaitez le mettre au rebut:

Veuillez contacter votre revendeur SHARP qui vous informera des conditions de reprise du produit. Les frais de reprise et de recyclage pourront vous être facturés. Les produits de petite taille (et en petites quantités) pourront être repris par vos organisations de collecte locales.

Espagne: veuillez contacter l'organisation de collecte existante ou votre administration locale pour les modalités de reprise de vos produits usagés.

2. Pays hors de l'Union européenne

Si vous souhaitez mettre ce produit au rebut, veuillez contacter votre administration locale qui vous renseignera sur la méthode d'élimination correcte de cet appareil.

Información sobre la eliminación



Atención: su producto está marcado con este símbolo. Significa que los productos eléctricos y electrónicos usados no deberían mezclarse con los residuos domésticos generales. Existe un sistema de recogida independiente para estos productos.

A. Información sobre eliminación para usuarios particulares

1. En la Unión Europea

Atención: si quiere desachar este equipo, ¡por favor no utilice el cubo de la basura habitual!

Los equipos eléctricos y electrónicos usados deberían tratarse por separado de acuerdo con la legislación que requiere un tratamiento, una recuperación y un reciclaje adecuados de los equipos eléctricos y electrónicos usados.

Tras la puesta en práctica por parte de los estados miembros, los hogares de particulares dentro de los estados de la Unión Europea pueden devolver sus equipos eléctricos y electrónicos a los centros de recogida designados sin coste alguno*.

En algunos países* es posible que también un vendedor local se lleve su viejo producto sin coste alguno si Ud. compra uno nuevo similar.

*) Por favor, póngase en contacto con su autoridad local para obtener más detalles.

Si sus equipos eléctricos o electrónicos usados tienen pilas o acumuladores, por favor deséchelos por separado con antelación según los requisitos locales.

Al desachar este producto correctamente, ayudará a asegurar que los residuos reciban el tratamiento, la recuperación y el reciclaje necesarios, previniendo de esta forma posibles efectos negativos en el medio ambiente y la salud humana que de otra forma podrían producirse debido a una manipulación de residuos inapropiada.

2. En otros países fuera de la Unión Europea

Si desea desachar este producto, por favor póngase en contacto con las autoridades locales y pregunte por el método de eliminación correcto.

Para Suiza: Los equipos eléctricos o electrónicos pueden devolverse al vendedor sin coste alguno, incluso si no compra ningún nuevo producto. Se puede encontrar una lista de otros centros de recogida en la página principal de www.swico.ch o www.sens.ch.

B. Información sobre Eliminación para empresas usuarias

1. En la Unión Europea

Si el producto se utiliza en una empresa y quiere desacharlo:

Por favor póngase en contacto con su distribuidor SHARP, quien le informará sobre la recogida del producto. Puede ser que le cobren los costes de recogida y reciclaje. Puede ser que los productos de tamaño pequeño (y las cantidades pequeñas) sean recogidos por sus centros de recogida locales.

Para España: por favor, póngase en contacto con el sistema de recogida establecido o con las autoridades locales para la recogida de los productos usados.

2. En otros países fuera de la Unión Europea

Si desea desachar este producto, por favor póngase en contacto con sus autoridades locales y pregunte por el método de eliminación correcto.

Information om återvinning



OBS! Produkten är märkt med symbolen ovan. Denna symbol indikerar att elektroniska produkter inte ska kastas i det vanliga hushållsavfallet eftersom det finns ett separat avfallshanterings-system för dem.

A. Information om återvinning av elektrisk utrustning för hushåll

1. EU-länder

OBS! Kasta inte denna produkt i soporna!

Förbrukad elektrisk utrustning måste hanteras i enlighet med gällande miljölagstiftning och återvinningsföreskrifter.

I enlighet med gällande EU-regler ska hushåll ha möjlighet att lämna in elektrisk utrustning till återvinningsstationer utan kostnad.*

I vissa länder* kan det även hända att man gratis kan lämna in gamla produkter till återförsäljaren när man köper en ny liknande enhet.

*) Kontakta kommunen för vidare information.

Om utrustningen innehåller batterier eller ackumulatörer ska dessa först avlägsnas och hanteras separat i enlighet med gällande miljöföreskrifter.

Genom att hantera produkten i enlighet med dessa föreskrifter kommer den att tas om hand och återvinnas på tillämpligt sätt, vilket förhindrar potentiella negativa hälso- och miljöeffekter.

2. Länder utanför EU

Kontakta de lokala myndigheterna och ta reda på gällande sorterings- och återvinningsföreskrifter om du behöver göra dig av med denna produkt.

B. Information om återvinning för företag

1. EU-länder

Gör så här om produkten ska kasseras:

Kontakta SHARPs återförsäljare för information om hur man går till väga för att lämna tillbaka produkten. Det kan hända att en avgift för transport och återvinning tillkommer. Mindre skrymmande produkter (om det rör sig om ett fåtal) kan eventuellt återlämnas till lokala återvinningsstationer.

2. Länder utanför EU

Kontakta de lokala myndigheterna och ta reda på gällande sorterings- och återvinningsföreskrifter om du behöver göra dig av med denna produkt.

Informazioni per un corretto smaltimento



Attenzione: Il dispositivo è contrassegnato da questo simbolo, che segnala di non smaltire le apparecchiature elettriche ed elettroniche insieme ai normali rifiuti domestici. Per tali prodotti è previsto un sistema di raccolta a parte.

A. Informazioni sullo smaltimento per gli utenti (privati)

1. Nell'Unione europea

Attenzione: Per smaltire il presente dispositivo, non utilizzare il normale bidone della spazzatura!

Le apparecchiature elettriche ed elettroniche usate devono essere gestite a parte e in conformità alla legislazione che richiede il trattamento, il recupero e il riciclaggio adeguato dei suddetti prodotti.

In seguito alle disposizioni attuate dagli Stati membri, i privati residenti nella UE possono conferire gratuitamente le apparecchiature elettriche ed elettroniche usate a centri di raccolta designati*.

In alcuni paesi*, anche il rivenditore locale può ritirare gratuitamente il vecchio prodotto se l'utente acquista un altro nuovo di tipo uguale simile.

*) Per maggiori informazioni si prega di contattare l'autorità locale competente.

Se le apparecchiature elettriche o elettroniche usate hanno batterie o accumulatori, l'utente dovrà smaltirle a parte preventivamente in conformità alle disposizioni locali.

Lo smaltimento corretto del presente prodotto contribuirà a garantire che i rifiuti siano sottoposti al trattamento, al recupero e al riciclaggio necessari prevenendo il potenziale impatto negativo sull'ambiente e sulla salute umana, che potrebbe derivare da un'incorretta gestione dei rifiuti.

2. In paesi che non fanno parte dell'UE

Se si desidera eliminare il presente prodotto, contattare le autorità locali e informarsi sul metodo di smaltimento corretto.

Per la Svizzera: Le apparecchiature elettriche o elettroniche usate possono essere restituite gratuitamente al rivenditore, anche se non si acquista un nuovo prodotto. Altri centri di raccolta sono elencati sulle homepage di www.swico.ch o di www.sens.ch.

B. Informazioni sullo smaltimento per gli utenti commerciali

1. Nell'Unione europea

Se il prodotto è impiegato a scopi commerciali, procedere come segue per eliminarlo.

Contattare il proprio rivenditore SHARP che fornirà informazioni circa il ritiro del prodotto. Potrebbero essere addebitate le spese di ritiro e riciclaggio. Prodotti piccoli (e quantitativi ridotti) potranno essere ritirati anche dai centri di raccolta locali.

Per la Spagna: Contattare il sistema di raccolta ufficiale o l'ente locale preposto al ritiro dei prodotti usati.

2. In paesi che non fanno parte dell'UE

Se si desidera eliminare il presente prodotto, contattare le autorità locali e informarsi sul metodo di smaltimento corretto.

Informação sobre Eliminação de Produtos



Atenção: O seu produto está identificado com este símbolo. Significa que os produtos eléctricos e electrónicos não devem ser misturados com o lixo doméstico comum. Existe um sistema de recolhas específico para estes produtos.

A. Informações sobre a Eliminação de Produtos para os Utilizadores (particulares)

1. Na União Europeia

Atenção: Se quiser eliminar este equipamento, não o deve fazer juntamente com o lixo doméstico comum!

O equipamento eléctrico e electrónico deve ser tratado separadamente e ao abrigo da legislação aplicável que obriga a um tratamento, recuperação e reciclagem adequados de equipamentos eléctricos e electrónicos usados.

Após a implementação desta legislação por parte dos Estados-membros, todos os cidadãos residentes na União Europeia poderão entregar o seu equipamento eléctrico e electrónico usado em estações de recolha específicas a título gratuito*.

Em alguns países* o seu revendedor local também pode recolher o seu equipamento usado a título gratuito na compra de um novo equipamento.

*) Contacte as entidades locais para mais informações.

Se o seu equipamento eléctrico e electrónico usado funcionar a pilhas ou baterias, deverá eliminá-las em separado, conforme a legislação local, e antes de entregar o seu equipamento.

Ao eliminar este produto correctamente estará a contribuir para que o lixo seja submetido aos processos de tratamento, recuperação e reciclagem adequados. Desta forma é possível evitar os efeitos nocivos que o tratamento inadequado do lixo poderia provocar no ambiente e na saúde.

2. Em outros Países fora da UE

Se quiser eliminar este produto, contacte as entidades locais e informe-se sobre o método correcto para proceder à sua eliminação.

Na Suíça: O equipamento eléctrico e electrónico é aceite, a título gratuito, em qualquer revendedor, mesmo que não tenha adquirido um novo produto. Poderá encontrar uma lista das estações de recolha destes equipamentos na página da Web www.swico.ch ou www.sens.ch.

B. Informações sobre a Eliminação de Produtos para Utilizadores-Empresas

1. Na União Europeia

Se o produto for usado para fins comerciais e quiser eliminá-lo:

Contacte o seu revendedor SHARP que irá informá-lo sobre a melhor forma de eliminar o produto. Poderá ter de pagar as despesas resultantes da recolha e reciclagem do produto. Alguns produtos mais pequenos (e em pequenas quantidades) poderão ser recolhidos pelas estações locais.

Na Espanha: Contacte o sistema de recolhas público ou as entidades locais para mais informações sobre a recolha de produtos usados.

2. Em outros Países fora da UE

Se quiser eliminar este produto, contacte as entidades locais e informe-se sobre o método correcto para proceder à sua eliminação.

Informatie over verantwoorde verwijdering



Let op: Uw product is van dit merkteken voorzien. Dit betekent dat afgedankte elektrische en elektronische apparatuur niet samen met het normale huishafval mogen worden weggegooid. Er bestaat een afzonderlijk inzamelings-systeem voor deze producten.

A. Informatie over afvalverwijdering voor gebruikers (particuliere huishoudens)

1. In de Europese Unie

Let op: Deze apparatuur niet samen met het normale huishafval weggoien! Afgedankte elektrische en elektronische apparatuur moet gescheiden worden ingezameld conform de wetgeving inzake de verantwoorde verwerking, terugwinning en recycling van afgedankte elektrische en elektronische apparatuur.

Na de invoering van de wet door de lidstaten mogen particuliere huishoudens in de lidstaten van de Europese Unie hun afgedankte elektrische en elektronische apparatuur kosteloos* naar hiertoe aangewezen inzamelingsinrichtingen brengen*.

In sommige landen* kunt u bij de aanschaf van een nieuw apparaat het oude product kosteloos bij uw lokale distributeur inleveren.

*) Neem contact op met de plaatselijke autoriteiten voor verdere informatie.

Als uw elektrische of elektronische apparatuur batterijen of accumulatoren bevat dan moet u deze afzonderlijk conform de plaatselijke voorschriften weggoien.

Door dit product op een verantwoorde manier weg te gooien, zorgt u ervoor dat het afval de juiste verwerking, terugwinning en recycling ondergaat en potentiële negatieve effecten op het milieu en de menselijke gezondheid worden voorkomen die anders zouden ontstaan door het verkeerd verwerken van het afval.

2. In andere landen buiten de Europese Unie

Als u dit product wilt weggoien, neem dan contact op met de plaatselijke autoriteiten voor informatie omtrent de juiste verwijderingsprocedure.

Voor Zwitserland: U kunt afgedankte elektrische en elektronische apparatuur kosteloos bij de distributeur inleveren, zelfs als u geen nieuw product koopt. Aanvullende inzamelingsinrichtingen zijn vermeld op de startpagina van www.swico.ch of www.sens.ch.

B. Informatie over afvalverwijdering voor bedrijven

1. In de Europese Unie

Als u het product voor zakelijke doeleinden heeft gebruikt en als u dit wilt weggoien:

Neem contact op met uw SHARP distributeur die u inlichtingen verschaft over de terugnane van het product. Het kan zijn dat u een afvalverwijderingsbijdrage voor de terugnane en recycling moet betalen. Kleine producten (en kleine hoeveelheden) kunnen door de lokale inzamelingsinrichtingen worden verwerkt.

Voor Spanje: Neem contact op met de inzamelingsinrichting of de lokale autoriteiten voor de terugnane van uw afgedankte producten.

2. In andere landen buiten de Europese Unie

Als u dit product wilt weggoien, neem dan contact op met de plaatselijke autoriteiten voor informatie omtrent de juiste verwijderingsprocedure.

Tietoja laitteen hävittämisestä



Huomio: Tuote on merkitty tällä symbolilla. Tämä tarkoittaa, että käytettyjä sähkö- ja elektronikalaitteita ei saa sekoittaa kotitalouden yleisjätteen kanssa. Näille tuotteille on olemassa erillinen keräysjärjestelmä.

A. Hävitysohjeet käyttäjälle (yksityiset kotitaloudet)

1. Euroopan unionissa

Huomio: Jos haluat hävittää tämän laitteen, älä käytä tavallista jätesäiliötä.

Käytetyt sähkö- ja elektronikalaitteet pitää hävittää erikseen noudattaen länsäädäntöä, joka takaa käytettyjen sähkö- ja elektronikalaitteiden oikean käsittelyn, keräämisen ja kierrättämisen.

Jäsenvaltioiden täytäntöönpanoa seuraten yksityiset kotitaloudet EU-laitteet jäsenvaltioissa voivat palauttaa käytetyt sähkö- ja elektronikalaitteet määrättyihin keräyspaikkoihin ilmaiseksi*. Joissakin maissa* paikalliset vähittäismyyjät voivat myös ottaa vastaan vanhan tuotteen ilmaiseksi, jos asiakas ostaa vastaavan uuden tuotteen.

*) Pyydä lisätietoja paikallisviranomaisilta.

Jos käytettyjä sähkö- tai elektronikalaitteita käytetään paristoja tai akkuja, hävitä nämä tuotteet etukäteen erikseen paikallisten säästöiden mukaisesti.

Hävittämällä tuotteen asianmukaisesti, autat varmistamaan, että jätteet käsitellään, kerätään ja kierrätetään asianmukaisella tavalla. Näin vältetään haitallisia ympäristö- ja terveysvaikutuksia, joita saattaa olla seuraamuksena jätteen epäasianmukaisesta käsittelystä.

2. Muissa maissa EU:n ulkopuolella

Jos haluat hävittää tuotteen, ota yhteyttä paikallisiin viranomaisiin ja pyydä ohjeita tuotteen asianmukaiseen hävittämiseen.

B. Hävitysohjeet yrityskäyttäjille

1. Euroopan unionissa

Jos tuotetta on käytetty yritysikäytössä, ja haluat hävittää sen, ota yhteyttä SHARP-jälleenmyyjään, joka antaa sinulle lisäohjeita tai ottaa tuotteen vastaan. Sinulta saatetaan veloitaa tuotteen vastaanottamisesta ja kierrätyksestä johtuvat kustannukset. Paikalliset keräyspisteet saattavat ottaa vastaan pienet tuotteet (ja pienet määrät).

2. Muissa maissa EU:n ulkopuolella

Jos haluat hävittää tuotteen, ota yhteyttä paikallisiin viranomaisiin ja pyydä ohjeita tuotteen asianmukaiseen hävittämiseen.

Informacje dotyczące usuwania zużytego urządzenia



A. Informacje dla użytkowników (prywatne gospodarstwa domowe) dotyczące usuwania odpadów

1. W krajach Unii Europejskiej

Uwaga: Jeśli chcą Państwo usunąć to urządzenie, prosimy nie używać zwykłych pojemników na śmieć!

Zużyty sprzęt elektryczny i elektroniczny należy usuwać oddzielnie, zgodnie z wymogami prawa dotyczącymi odpowiedniego przetwarzania, odzysku i recyklingu zużytego sprzętu elektrycznego i elektronicznego.

Uwaga: Państwa produkt oznaczony jest tym symbolem.

Oznacza to, że zużytego sprzętu elektrycznego i elektronicznego nie należy łączyć z odpadami z gospodarstw domowych. Dla tego typu produktów istnieje odrębny system zbiórki odpadów.

Po wdrożeniu przepisów unijnych w Państwach Członkowskich prywatne gospodarstwa domowe na terenie krajów UE mogą bezpłatnie zwracać zużyty sprzęt elektryczny i elektroniczny do wyznaczonych punktów zbiórki odpadów. W niektórych krajach* można bezpłatnie zwrócić stary produkt do lokalnych punktów sprzedaży detalicznej pod warunkiem, że zakupią Państwo podobny nowy produkt.

* W celu uzyskania dalszych informacji na ten temat należy skontaktować się z lokalnymi władzami.

Jeśli zużyty sprzęt elektryczny i elektroniczny jest wyposażony w baterie lub akumulatory, należy je usunąć oddzielnie, zgodnie z wymogami lokalnych przepisów.

Jeśli ten produkt zostanie usunięty we właściwy sposób, pomoga Państwo zapewnić, że odpady zostaną poddane przetworzeniu, odzyskowi i recyklingowi, a tym samym zapobiec potencjalnym negatywnym skutkom dla środowiska naturalnego i zdrowia ludzkiego, które w przeciwnym razie mogłyby mieć miejsce na skutek niewłaściwej obróbki odpadów.

2. Kraje pozaunijne

Jeśli chcą Państwo pozbyć się produktu, należy skontaktować się z władzami lokalnymi i uzyskać informacje na temat prawidłowej metody usunięcia produktu.

Dotyczy Szwajcarii: Zużyte urządzenia elektryczne i elektroniczne można zwrócić bezpłatnie do dostawcy, bez konieczności zakupu nowego produktu. Adresy punktów odbioru zużytego sprzętu można znaleźć na stronie www.swico.ch lub www.sens.ch.

B. Informacje dla użytkowników biznesowych dotyczące usuwania odpadów

1. W krajach Unii Europejskiej

W przypadku gdy produkt używany jest do celów handlowych i zamierzają go Państwo usunąć:

Należy skontaktować się z dealerm firmy SHARP, który poinformuje o możliwości zwrotu wyrobu. Być może będą Państwo musieli ponieść koszty zwrotu i recyklingu produktu. Produkty niewielkich rozmiarów (i w małej liczbie) można zwrócić do lokalnych punktów zbiórki odpadów.

Dotyczy Hiszpanii: Skontaktuj się z punktem odbioru lub władzami lokalnymi w sprawie oddania używanego produktu.

2. Kraje pozaunijne

Jeśli chcą Państwo usunąć ten produkt, należy skontaktować się z władzami lokalnymi i uzyskać informacje na temat prawidłowej metody jego usunięcia.

Informationen zur Batterieentsorgung

Die für dieses Produkt mitgelieferte Batterie kann Spuren von Blei enthalten.

Für die EU: Die durchgestrichene Abfalltonne bedeutet, dass gebrauchte Batterien nicht mit dem Hausmüll entsorgt werden sollten! Es gibt getrennte Sammelsysteme für gebrauchte Batterien, welche eine ordnungsgemäße Behandlung und Verwertung entsprechend gesetzlicher Vorgaben erlauben. Weitere Einzelheiten erhalten Sie von Ihrer Gemeindeverwaltung.

Für die Schweiz: Die gebrauchte Batterie kann an der Verkaufsstelle zurückgegeben werden.

Für andere Nicht-EU Staaten: Bitte erkundigen Sie sich bei Bedarf bei Ihrer Gemeindeverwaltung nach weiteren Informationen zur Entsorgung von gebrauchten Batterien.



Pb

Information sur la mise au rebut de la pile

Les piles/accus fournies avec ce produit peuvent contenir des traces de Plomb.

Au sein de l'Union Européenne : Le symbole de la poubelle sur roues barrée laisse supposer que les piles/accus usagées ne doivent pas être mélangées avec les déchets ménagers! Il existe un mode de collecte séparé pour les piles/accus usagées, ce qui permet d'effectuer un traitement et un recyclage en accord avec la législation. Veuillez contacter une autorité locale pour plus de renseignements sur le système mis en place.

Pour la Suisse : Les piles/accus usagées doivent être retournées chez votre détaillant.

Pour les pays hors Union Européenne : Veuillez contacter une autorité locale afin de connaître la bonne méthode à utiliser pour la collecte de vos piles/accus usagées.



Pb

Information on Proper Disposal

A. Information on Disposal for Users (private households)

1. In the European Union

Attention: If you want to dispose of this equipment, please do not use the ordinary dustbin!

Used electrical and electronic equipment must be treated separately and in accordance with legislation that requires proper treatment, recovery and recycling of used electrical and electronic equipment.

Following the implementation by member states, private households within the EU states may return their used electrical and electronic equipment to designated collection facilities free of charge*.

In some countries* your local retailer may also take back your old product free of charge if you purchase a similar new one.

* Please contact your local authority for further details. If you used electrical or electronic equipment has batteries or accumulators, please dispose of these separately beforehand according to local requirements.

By disposing of this product correctly you will help ensure that the waste undergoes the necessary treatment, recovery and recycling and thus prevent potential negative effects on the environment and human health which could otherwise arise due to inappropriate waste handling.

2. In other Countries outside the EU

If you wish to discard this product, please contact your local authorities and ask for the correct method of disposal.

For Switzerland: Used electrical or electronic equipment can be returned free of charge to the dealer, even if you don't purchase a new product. Further collection facilities are listed on the homepage of www.swico.ch or www.sens.ch.

B. Information on Disposal for Business Users

1. In the European Union

If the product is used for business purposes and you want to discard it:

Please contact your SHARP dealer who will inform you about the take-back of the product. You might be charged for the costs arising from take-back and recycling. Small products (and small amounts) might be taken back by your local collection facilities.

For Spain: Please contact the established collection system or your local authority for take-back of your used products.

2. In other Countries outside the EU

If you wish to discard of this product, please contact your local authorities and ask for the correct method of disposal.



Pb

Información sobre la eliminación de la batería

Las baterías suministradas con este producto contienen pequeñas cantidades de Plomo.

Para EU: El contenedor de basura con ruedas tachado indica que las baterías usadas no deberían mezclarse con los residuos domésticos generales. Existe un sistema de recogida independiente de baterías usadas, para permitir un correcto tratamiento y reciclado de acuerdo con la legislación vigente. Por favor póngase en contacto con el sistema de recogida establecido o con las autoridades locales para la recogida selectiva de las baterías usadas.

Para Suiza: Las baterías usadas deben ser retornadas al punto de venta.

Para otros países fuera de la Unión Europea: Por favor póngase en contacto con las autoridades locales para un correcto procedimiento de eliminación de las baterías usadas.

Information om batteriavyttring

Batteriet som följer med denna produkt kan innehålla spår av Bly.

För EU: Batteriet är märkt med den överkorsade sopunnan vilket betyder att det inte ska kastas i det vanliga hushållsavfallet. Det finns ett separat insamlingsystem för batterier för att underlätta korrekt behandling och återvinning enligt gällande lagstiftning. Kontakta kommunen för vidare information om insamling och återvinning.

För Schweiz: Använda batterier lämnas till inköpsstället.

För länder utanför EU: Kontakta de lokala myndigheterna för information om gällande sorterings- och återvinningsföreskrifter om du behöver göra dig av med ett använt batteri.



Pb



Pb

Informazioni sullo smaltimento della batteria

La batteria fornita con questo prodotto contiene tracce di Piombo.
Per EU: Il cassonetto barrato indica che le batterie usate non devono essere gettate assieme ai rifiuti domestici! Vi è un sistema di raccolta differenziata per le batterie usate, che consente il loro corretto trattamento e riciclo secondo quanto previsto dalle leggi vigenti. Vi prego di contattare le locali autorità per i dettagli del sistema di raccolta e riciclaggio.

Per la Svizzera: Le batterie usate devono essere restituite al punto vendita.

Per altri Stati non-EU: Vi prego di contattare le autorità locali per conoscere il metodo corretto di conferimento delle batterie usate.

Informatie over afvalverwerking van batterijen

De batterij die bij dit toestel geleverd wordt bevat sporen van Lood.
Voor EU: De doorgestreepte vuilnisbak op welkjes duidt aan dat de gebruikte batterijen niet mogen terecht komen in het gewone huishoudelijke afval. Er bestaat een gescheiden ophaalsysteem voor deze gebruikte batterijen om eigen behandeling en recyclage volgens de wetgeving toe te laten. Gelieve de lokale autoriteiten te contacteren voor de details van ophaling en recyclage.

Voor Zwitserland: De gebruikte batterij moet bij het verkooppunt teruggebracht worden.

Voor andere niet EU landen: Gelieve contact op te nemen met uw lokale autoriteiten voor de correcte methode van verwerking van de gebruikte batterijen.

Informação sobre Eliminação de Pilhas

A bateria fornecida com este produto contém traços de chumbo.
Para a União Europeia: O contendor de rodas traçado significa que as baterias usadas não deverão ser colocadas junto com o lixo doméstico! Existe um sistema de separação próprio para baterias usadas, para permitir um tratamento e reciclagem própria de acordo com a legislação em vigor. Por favor contacte as autoridades locais para mais detalhes nos esquemas de recolha e reciclagem.

Para a Suíça: As baterias usadas deverão ser devolvidas ao ponto de venda.

Para os outros países fora da União Europeia: Por favor contacte a sua autoridade local para o método correcto de disposição das baterias usadas.



Pb

Tietoja paristojen hävittämisestä

Tämän tuotteen mukana oleva paristo/akku saattaa sisältää jätteitä Lyijy.

EU-maat: Paristo/akku on merkitty yliviivatun roskasäiliön symbolilla, mikä tarkoittaa, että sitä ei saa hävittää kotitalouden yleisjätteiden kanssa. Paristoille/akuille on olemassa erillinen keräysjärjestelmä, joka helpottaa niiden asianmukaista käsittelyä ja lainmukaista kierrätystä. Ota yhteys kuntaviranomaisiin saadaksesi lisätietoa keräyksestä ja kierrätyksestä.

Sveitsi: Käytetyt paristot/akut palautetaan ostopaikkaan.

EU:n ulkopuoliset maat: Ota yhteys paikallisviranomaisiin saadaksesi lisätietoa voimassa olevista lajitelu- ja kierrätysäädöksistä ja ohjeet käytetyn pariston/akun hävittämiseen.

Informacja na temat usuwania baterii

Bateria dostarczona z tym produktem zawiera śladowe ilości ołowiu.

W krajach Unii Europejskiej: Przekreślony pojemnik na odpady oznacza, że zużytych baterii nie należy wyrzucać do pojemników z odpadami domowymi! Dla zużytych baterii istnieją oddzielne systemy zbiórki, które zapewniają prawidłowe przetwarzanie i odzysk zgodnie z obowiązującym prawem. Szczegóły na temat systemów zbiórki otrzymają Państwo u lokalnych władz.

W Szwajcarii: Zużyte baterie można zwrócić w punkcie sprzedaży.
Kraje pozaunijne: W celu uzyskania szczegółowych informacji na temat prawidłowej metody pozbycia się zużytych baterii, proszę o kontakt z władzami lokalnymi.

Information on Battery Disposal

The battery supplied with this product contains traces of Lead.

For EU: The crossed-out wheeled bin implies that used batteries should not be put to the general household waste! There is a separate collection system for used batteries, to allow proper treatment and recycling in accordance with legislation. Please contact your local authority for details on the collection and recycling schemes.

For Switzerland: The used battery is to be returned to the selling point.

For other non-EU countries: Please contact your local authority for correct method of disposal of the used battery.



Pb



Pb

“DLNA[®], das DLNA Logo und DLNA CERTIFIED[™] Markenzeichen, Dienstleistungsmarken oder Gütezeichen der Digital Living Network Alliance.”

“DLNA[®], le logo DLNA et DLNA CERTIFIED[™] sont des marques de commerce, des marques de service ou des marques de certification de la Digital Living Network Alliance.”

“DLNA[®], el logotipo DLNA y DLNA CERTIFIED[™] son marcas registradas, marcas de servicio, o marcas de certificación de Digital Living Network Alliance.”

“DLNA[®], DLNA-logotypen och DLNA CERTIFIED[™] är varumärken, tjänster eller certifieringar som tillhör Digital Living Network Alliance.”

“DLNA[®], il logo DLNA e DLNA CERTIFIED[™] sono marchi depositati, di servizio o di certificazione della Digital Living Network Alliance.”

“DLNA[®], het DLNA logo en DLNA CERTIFIED[™] zijn handelsmerken, servicemerken of keurmerken van Digital Living Network Alliance.”

“DLNA[®], o logo DLNA e DLNA CERTIFIED[™] sao marcas registadas, marcas de serviço ou marcas certificadas da Digital Living Network Alliance.”

“DLNA[®], DLNA-logo ja DLNA CERTIFIED[™] ovat Digital Living Network Alliance -yhtiön tavaramerkkejä, palvelumerkkejä tai sertifiointimerkkejä.”

“DLNA[®], logo DLNA i DLNA CERTIFIED[™] są znakami handlowymi, znakami serwisowymi lub znakami certyfikacyjnymi Digital Living Network Alliance.”

“DLNA[®], the DLNA Logo and DLNA CERTIFIED[™] are trademarks, service marks, or certification marks of the Digital Living Network Alliance.”

Introduction





Thank you for purchasing this SHARP product. To obtain the best performance from this product, please read this manual carefully. It will guide you in operating your SHARP product.

Special Note

Supply of this product does not convey a license nor imply any right to distribute content created with this product in revenue-generating broadcast systems (terrestrial, satellite, cable and/or other distribution channels), revenue-generating streaming applications (via Internet, intranets and/or other networks), other revenue-generating content distribution systems (pay-audio or audio-on-demand applications and the like) or on revenue-generating physical media (compact discs, digital versatile discs, semiconductor chips, hard drives, memory cards and the like). An independent license for such use is required. For details, please visit <http://mp3licensing.com>
 MPEG Layer-3 audio coding technology licensed from Fraunhofer IIS and Thomson.

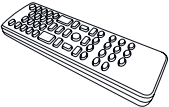
Accessories

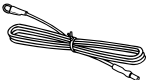
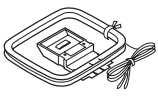
The following accessories are included.

 Remote control x 1 (RRMCGA279AWSA)	 "AA" size battery (UM/SUM-3, R6, HP-7 or similar) x 1	 FM aerial x 1
 AM loop aerial x 1	 Stand for iPad x 1	 Dock Spacer x 1

CONTENTS

	Page		Page
General Information		USB	
Precautions	2	Listening to USB mass storage device/MP3 player	13 - 14
Controls and indicators	2 - 3	Advanced USB playback	14 - 15
Preparation for Use		Radio	
System connections	4	Listening to the radio	15
Remote control	4	Advanced Features	
Basic Operation		Using the Radio Data System (RDS)	16 - 18
General control	5	Timer and sleep operation (Remote control only)	18 - 19
Setting the clock (Remote control only)	6	Enhancing your system	19 - 20
AirPlay / DLNA		References	
Wi-Fi network setup for AirPlay / DLNA	6 - 8	Troubleshooting chart	20 - 22
iPod, iPhone and iPad		Maintenance	22
Listening to the iPod, iPhone or iPad	9 - 10	Specifications	22
CD or MP3/WMA disc Playback			
Listening to a CD or MP3/WMA disc	11		
Advanced CD or MP3/WMA disc playback	11 - 12		
MP3/WMA folder mode (only for MP3/WMA files)	13		

Precautions

General

- Please ensure that the equipment is positioned in a well ventilated area and ensure that there is at least 10 cm (4") of free space along the sides, top and back of the equipment.

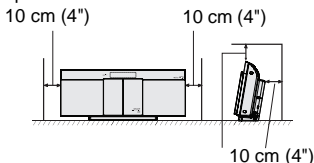

- Use the unit on a firm, level surface free from vibration.
- Place the unit at least 30 cm (12") away from any CRT TV to avoid colour variations across the TV screen. If the variations persist, move the unit further away from the TV. LCD TV is not prone to such variation.
- Keep the unit away from direct sunlight, strong magnetic fields, excessive dust, humidity and electronic/electrical equipment (home computers, facsimiles, etc.) which generate electrical noise.
- Do not place anything on top of the unit.
- Do not expose the unit to moisture, to temperatures higher than 40°C (104°F) or to extremely low temperatures.
- If your system does not work properly, disconnect the AC power lead from the wall socket. Plug the AC power lead back in, and then turn on your system.
- In case of an electrical storm, unplug the unit for safety.
- Hold the AC power plug by the head when removing it from the wall socket, as pulling the lead can damage internal wires.

- The AC power plug is used as a disconnect device and shall always remain readily operable.
- **Do not remove the outer cover, as this may result in electric shock. Refer internal service to your local SHARP service facility.**
- The ventilation should not be impeded by covering the ventilation openings with items, such as newspapers, tablecloths, curtains, etc.
- No naked flame sources, such as lighted candles, should be placed on the apparatus.
- Attention should be drawn to the environmental aspects of battery disposal.
- This unit should only be used within the range of 5°C - 35°C (41°F - 95°F).
- The apparatus is designed for use in moderate climates.

Warning:

The voltage used must be the same as that specified on this unit. Using this product with a higher voltage other than that which is specified is dangerous and may result in a fire or other type of accident causing damage. SHARP will not be held responsible for any damage resulting from use of this unit with a voltage other than that which is specified.

Volume control

The sound level at a given volume setting depends on speaker efficiency, location, and various other factors. It is advisable to avoid exposure to high volume levels. Do not turn the volume on to full at switch on. Listen to music at moderate levels. Excessive sound pressure from earphones and headphones can cause hearing loss.

Controls and indicators

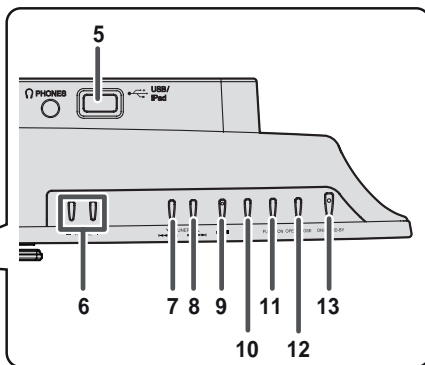
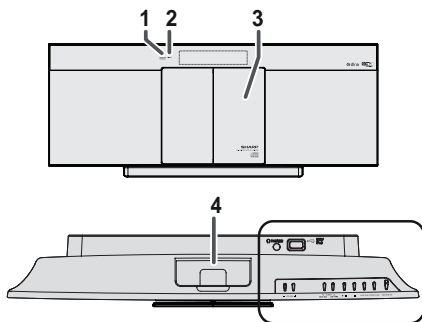

Front panel

	Page
1. Remote sensor	4
2. Timer indicator	19
3. Disc Compartment	11
4. Docking Station for iPod or iPhone	9
5. USB Terminal	9, 13
6. Volume Control	5
7. Tuner Preset Down, CD/USB Track Down, iPod/iPhone Skip Down	10, 14

	Page
8. Tuner Preset Up, CD/USB Track Up, iPod/iPhone Skip Up	10, 14
9. Disc/USB/iPod/iPhone Play or Pause Button	9, 11
10. Disc/USB Stop Button	11, 14
11. FUNCTION Button	5
12. Disc Compartment Open/Close Button	11
13. On/Stand-by Button	5

Controls and indicators (continued)

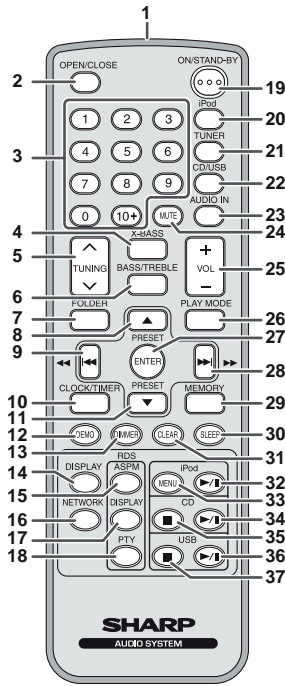

Remote control

	Page
1. Remote Control Transmitter	4
2. Open / Close Button	11
3. Numeric Buttons	11
4. X-Bass Button	5
5. Tuning Up / Down Button	15
6. Bass / Treble Button	5
7. Folder Button	13
8. Tuner Preset Up Button, iPod Cursor Up	6, 10, 13, 15
9. Skip Down, Fast Reverse, Time Down Button	6, 8, 10, 11, 14, 18
10. Clock/Timer Button	6, 18, 19
11. Tuner Preset Down Button, iPod Cursor Down	6, 10, 13, 15
12. Demo Button	4
13. Dimmer Button	5
14. Display Button	13, 14
15. RDS ASPM Button	16
16. Network Button	6, 7
17. RDS Display Button	16
18. RDS PTY Button	17
19. On/Stand-by Button	5, 6, 9, 18
20. iPod Button	10
21. Tuner Button	15, 16
22. CD/USB Button	11, 14
23. Audio In Button	19
24. Mute Button	5
25. Volume Up/Down Button	5
26. Play Mode Button	12
27. Enter Button	6, 7, 10, 18
28. Skip Up, Fast Forward, Time Up Button	6, 8, 10, 11, 14, 18
29. Memory Button	12, 15
30. Sleep Button	19
31. Clear Button	12
32. iPod Play/Pause Button	10
33. iPod Menu Button	6, 7, 10
34. CD Play/Pause Button	11, 12
35. CD Stop Button	11, 12
36. USB Play/Pause Button	14
37. USB Stop Button	13, 14

Display

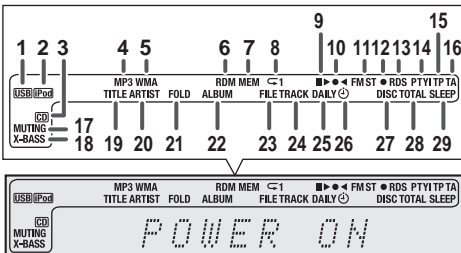

	Page
1. USB Indicator	13
2. iPod Indicators	9
3. CD Indicator	10
4. MP3 Indicator	11
5. WMA Indicator	11
6. RDM (Random) Indicator	12
7. MEM (Memory) Indicator	12

	Page
8. Repeat Indicator	12
9. Play/Pause Indicator	11
10. Tuning FM Indicator	15
11. FM Stereo Mode Indicator	15
12. Stereo Station Indicator	15
13. RDS Indicator	16
14. PTY Indicator	16
15. TP Indicator	16
16. TA Indicator	16
17. Muting Indicator	5
18. X-bass Indicator	5
19. Title Indicator	13
20. Artist Indicator	13
21. Folder Indicator	13
22. Album Indicator	13
23. File Indicator	13
24. Track Indicator	12
25. Daily Timer Indicator	18
26. Once Timer Indicator	18
27. Disc Indicator	11
28. Total Indicator	13
29. Sleep Indicator	19

System connections

Make sure to unplug the AC power lead before making any connections.

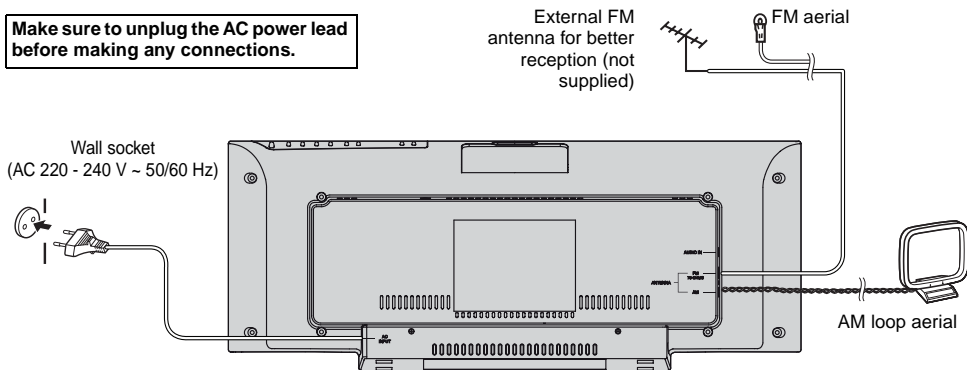

■ Aerial connection

Supplied FM aerial:

Connect the FM aerial wire to the FM 75 OHMS socket and position the FM aerial wire in the direction where the strongest signal can be received.

External FM aerial:

Use an external FM aerial (75 ohms coaxial cable) for better reception. When an external FM aerial is used, disconnect the supplied FM aerial wire.

Supplied AM loop aerial:

Connect the AM loop aerial to the AM and earth (GND) terminals. Position the AM loop aerial for optimum reception. Place the AM loop aerial on a shelf, etc., or attach it to a stand or a wall with screws (not supplied).

Installing the AM loop aerial:

<Assembling> <Attaching to the wall>

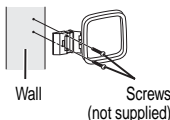
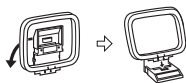

Note:

Placing the aerial on the unit or near the AC power lead may cause noise pickup. Place the aerial away from the unit for better reception.

■ AC power connection

After checking all the connections have been made correctly, plug the AC power lead of this unit into the wall socket.

Note:

Unplug the AC power lead from the wall socket if the unit will not be in use for a prolonged period of time.

■ Demonstration (Network stand-by) mode

- The first time the unit is plugged in, the unit will enter the demonstration mode. (refer page 8)

Network ST-BY

- To cancel the demonstration mode, press the DEMO button (remote control) during power stand-by mode. The unit will enter the low power consumption mode.
- To return to the demonstration mode, press the DEMO button again.
- If iPod or iPhone is docked, the unit will begin charging. "Charge Mode" will be displayed. Demonstration mode is invalid during charge mode.

Remote control

■ Battery installation

- 1 Open the battery cover.
- 2 Insert the supplied battery according to the terminal indicated in the battery compartment.

When inserting or removing the battery, push it towards the (-) battery terminals.

- 3 Close the cover.

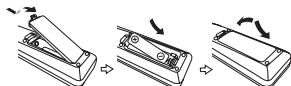

Caution:

- Remove the battery if the unit will not be used for a long period of time. This will prevent potential damage due to battery leakage.
- Do not use rechargeable battery (nickel-cadmium battery, etc.).
- Installing the battery incorrectly may cause the unit to malfunction.
- Batteries (battery pack or batteries installed) shall not be exposed to excessive heat such as sunshine, fire or the like.

Notes concerning use:

- Replace the battery if the operating distance is reduced or if the operation becomes erratic. Purchase an "AA" size battery (UM/SUM-3, R6, HP-7 or similar).
- Periodically clean the transmitter on the remote control and the sensor on the unit with a soft cloth.

- Exposing the sensor on the unit to strong light may interfere with operation. Change the lighting or the direction of the unit if this occurs.
- Keep the remote control away from moisture, heat, shock, and vibrations.

■ Test of the remote control

Check the remote control after checking all the connections. Point the remote control directly at the remote sensor on the unit. The remote control can be used within the range shown below:

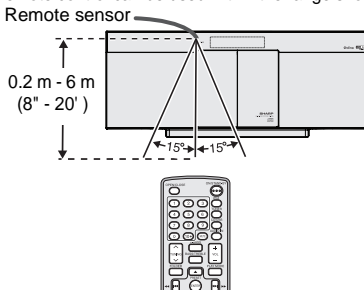

General control

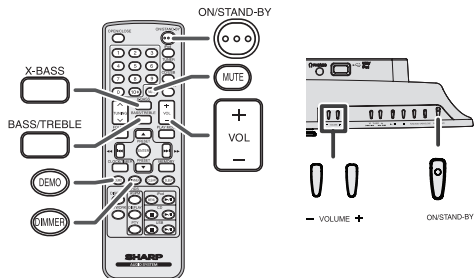

■ To turn the power on

Press the ON/STAND-BY button to turn the power on.

After use:

Press the ON/STAND-BY button to enter the power stand-by mode.

■ Display brightness control

To dim the display brightness, press the DIMMER button on the remote control.

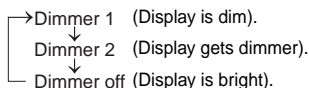

■ Volume auto fade-in

If you turn off and on the main unit with the volume set to 27 or higher, the volume starts at 16 and fades in to the last set level.

■ Volume control

Press VOL +/- to increase or decrease the volume.

■ Muting

The volume is muted temporarily when pressing the MUTE button on the remote control. Press again to restore the volume.

■ Direct key power on function

When you press any of the following buttons, the unit turns on.
 ● iPod, CD/USB, AUDIO IN, TUNER, NETWORK on the remote control: Selected function is activated.

● ▶/|| button on the main unit: The unit turns on and playback of the last function will start (CD, TUNER, USB, iPod, AUDIO IN, NETWORK)

■ Auto power off function

The main unit will enter the stand-by mode (when iPad, iPod or iPhone is not connected) after 15 minutes of inactivity during:

iPod: Not docked.

Audio In: No detection of input signal.

CD: In the stop mode or no disc.

USB: In the stop mode or no media.

Note:

However, if iPod or iPhone is docked, the unit will begin charging.

"Charge Mode" will be displayed.

■ Auto power on

During stand-by mode, when you select DK-KP95PH speaker through AirPlay icon on your AirPlay device, the unit will automatically power on to Network function and stream the music from your AirPlay device.

This condition applies when:

- The AirPlay network has previously been set up between the unit and your AirPlay device.
- Set the Network Stand-by mode to ON. (refer page 8)

■ AirPlay auto switch

During other function (CD, TUNER, USB, iPod, Audio In), when you select DK-KP95PH speaker through AirPlay icon on your AirPlay device, the unit will automatically switch to Network function and stream the music from your AirPlay device.

This condition applies when:

- The AirPlay network has previously been set up between the unit and your AirPlay device.

■ X-Bass control

When the power is first turned on, the unit will enter the extra bass mode which emphasises the bass frequencies, and "X-BASS" indicator will appear. To cancel the extra bass mode, press the X-BASS button on the remote control.

■ Bass control

- 1 Press the BASS/TREBLE button to select "Bass".
- 2 Within 5 seconds, press the VOLUME (+ or -) button to adjust the bass. "X-BASS" indicator will disappear.



■ Treble control

- 1 Press the BASS/TREBLE button to select "Treble".
- 2 Within 5 seconds, press the VOLUME (+ or -) button to adjust the treble. "X-BASS" indicator will disappear.



■ Function

When the FUNCTION button on main unit is pressed, the current function will change to different mode. Press the FUNCTION button repeatedly to select desired function.

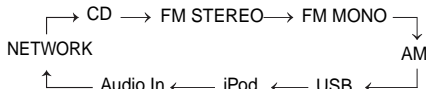

Note:

The backup function will protect the memorised function mode for a few hours should there be a power failure or the AC power lead becomes disconnected.

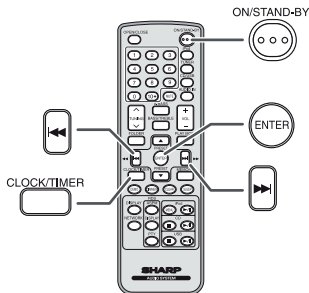

In this example, the clock is set for the 24-hour (0:00) display.

- 1 Press the ON/STAND-BY button to turn the power on.
- 2 Press the CLOCK/TIMER button.
- 3 Within 5 seconds, press the ◀ or ▶ button and then press the ENTER button.
- 4 Press the ◀ or ▶ button to select 24-hour or 12-hour display and then press the ENTER button.

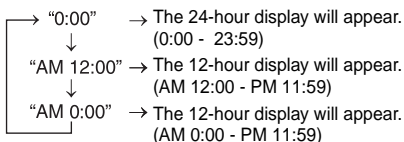

- 5 To adjust the hour, press the ◀ or ▶ button and then press the ENTER button. Press the ◀ or ▶ button once to advance the time by 1 hour. Hold it down to advance continuously.
- 6 To adjust the minutes, press the ◀ or ▶ button and then press the ENTER button. Press the ◀ or ▶ button once to advance the time by 1 minute. Hold it down to advance the time by 5 minutes interval.

To confirm the time display:

Press the CLOCK/TIMER button. The time display will appear for about 5 seconds.

Note:

When power supply is restored after unit is plugged in again or after a power failure, reset the clock.

To readjust the clock:

Perform "Setting the clock" from step 1. If the "Clock" does not appear in step 2, step 4 (for selecting the 24-hour or 12-hour display) will be skipped.

To change the 24-hour or 12-hour display:

- 1 Clear all the programmed contents. [Refer to "Factory reset, clearing all memory" on page 21 for details.]
- 2 Perform "Setting the clock" from step 1 onwards.

(AirPlay)

With Apple AirPlay technology, you can stream your music from your iTunes on a Mac, PC, iPhone, iPod touch, or iPad to external speakers (DK-KP95PH) via a Wi-Fi network.

AirPlay usage requires:

- MacBook or MacBook Pro running MacOS 10.6.6 or greater.
- iTunes 10.2 or greater (Mac/PC).
- iOS 4.3 or later
 - iPod touch (4th, 3rd and 2nd generation)
 - iPhone 4
 - iPhone 3GS (iPhone 3G cannot support AirPlay)
 - iPad 2
 - iPad

(DLNA)

DLNA technology enables you to share media from one device to another via a Wi-Fi network.

DLNA usage requires:

- DLNA compatible devices with appropriate application. (Refer to your devices' manual) Support status varies depending on model and software features such as client and server functions.
- PC with Windows 7.
- DLNA version 1.5
- This product supports audio source with playback capability only. Streaming (audio and video) from DLNA devices is not supported by this product.
- DRM file playback (DTCP-IP) is not supported.
- Sharp does not guarantee that this product will work with all DLNA compatible devices and wireless LAN routers.

Note:

When this unit is placed too near a Wireless LAN device or microwave, noise interference may occur, causing crackling sound. It may also reduce the communication speed and cause invalid connection. If these happen, do the following:

- Place the unit away from the Wireless LAN device or microwave.
- Place the unit closer to the source device.

■ Direct wireless connection

- 1 Press the ON/STAND-BY button.
- 2 Press the NETWORK button.
- 3 Press the iPod MENU button on the remote control.
- 4 Press the ▼/▲ button to select 'Wi-Fi Setup'. Press the ENTER button.
- 5 Press the ▼/▲ button to select 'Direct'. Press the ENTER button. Wait until '•' on the display turns off and shows 'Direct Ready' which takes about 40 seconds.
- 6 On the iPod touch/iPhone/iPad, select 'Settings' --> 'Wi-Fi'. On the PC/Mac, enter the list of available wireless networks.

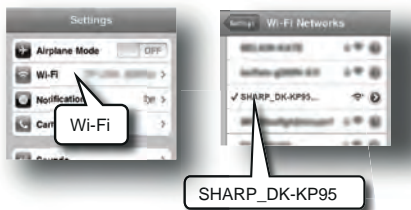

For other DLNA compatible devices, turn on the Wi-Fi. For more details, refer to your devices' manual.

- 7 Select SHARP_DK-KP95 from the list of available networks.

Wi-Fi network Setup for AirPlay / DLNA (continued)

8 Launch **Music** and play desired song on your iPod touch / iPhone or iPad. For PC/Mac, launch **iTunes**.

For other DLNA compatible devices', launch the DLNA compatible media software. For more details, refer to your DLNA compatible devices' manual.

9 Tap / click on the **AirPlay** icon .

Select the speaker : **SHARP_DK-KP95_xxxxxx**.

Sound will be heard from the DK-KP95 speakers via audio streaming.

Note: 'xxxxxx' is MAC ID.



■ Connection via SSID (wireless router without WPS)

- 1** Press the ON/STAND-BY button.
- 2** Press the NETWORK button on the remote control.
- 3** Press the iPod MENU button on the remote control.
- 4** Press the ▼/▲ button to select '**Wi-Fi Setup**'. Press the ENTER button.
- 5** Press the ▼/▲ button to select '**SSID Set**'. Press the ENTER button. Wait until the display shows "**SSID Ready**" which takes about 40 seconds.
- 6** On the iPod touch/iPhone/iPad, select '**Settings**' --> '**Wi-Fi**'. On the PC/Mac, enter the list of available wireless networks. For other DLNA compatible devices, turn on the Wi-Fi. For more details, refer to your devices' manual.
- 7** Select **Sharp_DK-KP95** from the list of available networks.
- 8** Open web browser as Safari or Explorer on iPod touch / iPhone / iPad or PC/Mac. Type **192.168.1.1** at the address bar. The DK-KP95 configuration page is displayed.

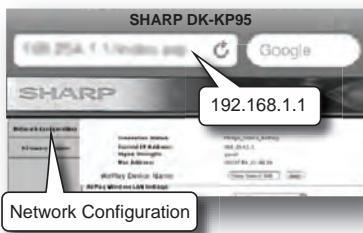

■ Connection via wireless router with WPS

1 Press the WPS button on the wireless router.

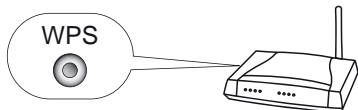

- 2** Press the ON/STAND-BY button.
- 3** Press the NETWORK button.
- 4** Press the iPod MENU button on the remote control.
- 5** Press the ▼/▲ button to select '**Wi-Fi Setup**'. Press the ENTER button.
- 6** Press the ▼/▲ button to select '**WPS**'. Press the ENTER button. Wait until '▶▶▶' on the display stop blinking and the display shows "**Successfully Connected to [network name]**".
- 7** On the iPod touch/iPhone/iPad, select '**Settings**' --> '**Wi-Fi**'. On the PC/Mac, enter the list of available wireless networks. For other DLNA compatible devices, turn on the Wi-Fi. For more details, refer to your devices' manual.
- 8** Select your router from the list of available networks. Enter your network password if required.

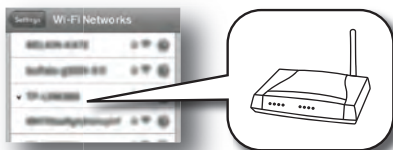

9 Continue with step 8 to 9 in '**Direct wireless connection**' of page 6.

Note:

WPS process (network search) takes about 2 minutes. If fail to connect, the display will show '**Cannot connect to Network**'. Repeat step 4 to retry.

9 Select **Network Configuration** tab.

10 Select your router SSID from the pull-down list of **Service Set ID (SSID)**.

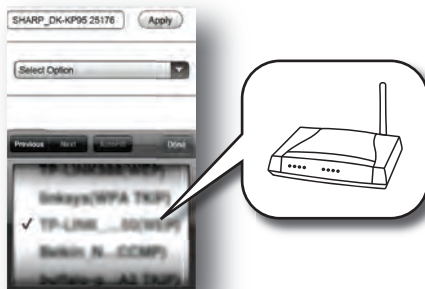

11 Enter your network password if required (for some routers, you may also need to tick **DHCP** under **Advance Setting**).

Wi-Fi network Setup for AirPlay / DLNA (continued)

- 12 Change the name of SHARP_DK-KP95_xxxxxx in **AirPlay Device Name** if you like and click **Apply** (*1).
 13 Click **Apply** (*2) at the bottom of the page to apply your settings.



- 14 Click **OK** to confirm your settings.
 15 On the iPod touch/iPhone/iPad, select '**Settings**' --> '**Wi-Fi**'.
 On the PC/Mac, enter the list of available wireless networks.
 16 Select your router from the list of available networks.

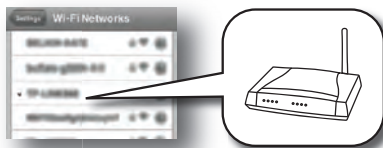

- 17 Continue with step 8 to 9 in '**Direct wireless connection**' of page 6.

■ Connection of an AirPlay device to the same Wi-Fi network

You can add other AirPlay devices to join the same Wi-Fi network as the unit.

- On the iPod touch/iPhone/iPad, select '**Settings**' --> '**Wi-Fi**'.
 On the PC/Mac, enter the list of available wireless networks.
 For other DLNA compatible devices, turn on the Wi-Fi.
 For more details, refer to your devices' manual.
- Select your router SSID from the list of available wireless networks.

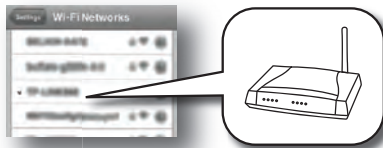

- Wait until successful Wi-Fi connection from the additional AirPlay devices to the router.
- Continue with step 8 to 9 in '**Direct wireless connection**' of page 6.

Notes:

- This product may face some irregularities due to various unforeseen reasons from other devices in the process of Wi-Fi pairing. Should this happen, unplug the AC power lead, and plug it back in.
- If the Network function operates incorrectly, do the Network reset (refer page 21).

■ Various function control during AirPlay / DLNA

Various function can be controlled from the remote control or your AirPlay / DLNA device.

Function	Main unit	Remote control	AirPlay device
Volume up/ down			✓
Play/pause		—	✓
Next/previous track			✓
Mute	—		—
Display	—		—

Notes:

- For DLNA compatible devices, the function control may vary depending on DLNA application used.
- To enable this unit to control iTunes software, the setting below is required.

For Mac iTunes:

- On the toolbar menu, click **iTunes** and select **Preferences**.
- Under **Devices** tab, check the ' **Allow iTunes audio control from remote control speakers**' box.

For Window iTunes:

- On the toolbar menu, click **Edit** and select **Preferences**.
- Under **Devices** tab, check the ' **Allow iTunes control from remote control speakers**' box.

■ Network Stand-by mode

On: Network Stand-by mode is enable.

During stand-by mode, if select DK-KP95PH speakers through AirPlay icon and tap/click PLAY on AirPlay device, the unit will automatically power on and stream the music from your AirPlay device.

To enable the Network Stand-by mode :

During Stand-by mode, press DEMO button on remote control to select the Network Stand-by mode on or off.

To check the IP address of the router / Mac ID / SSID:

- Press iPod MENU button on the remote control.
- Press ▼/▲ button on the remote control repeatedly.
 The display will toggle as below:



Listening to the iPod, iPhone or iPad

Made for:

- iPod touch (4th generation)
- iPod touch (3rd generation)
- iPod touch (2nd generation)
- iPod touch (1st generation)
- iPod classic
- iPod nano (6th generation)
- iPod nano (5th generation)
- iPod nano (4th generation)
- iPod nano (3rd generation)
- iPod nano (2nd generation)
- iPhone 4
- iPhone 3GS
- iPhone 3G
- iPhone
- iPad 2
- iPad

Caution:

Please update your iPod, iPhone and iPad unit to the latest software version before using it. Please visit Apple's homepage to download the latest version for your iPod, iPhone and iPad.

Notes:

- Charging terminal for iPod, iPhone and iPad:

Condition	DOCK	USB terminal
USB function	YES	YES (without iPod or iPhone docking)
Other function (iPod / CD / Network Tuner / Audio In)	YES	NO
Stand-by	YES	NO

- The message "This accessory is not made to work with iPhone" or similar, may appear on the iPhone screen when:
 - battery is low.
 - the iPhone is not properly docked (eg. slanting). If this occurs, remove and re-dock the iPhone.
- **This product is made for iPod, iPhone and iPad. To prevent random interference when iPod, iPhone or iPad is connected, the headphone output of main unit is disabled, and "HP INVALID" will be displayed. You may also experience brief audio interference during incoming calls.**
- The headphone output of main unit is switched off during inserting iPod, iPhone and iPad unit. This is an Apple product specification.

■ iPod, iPhone and iPad connection via USB terminal

- 1 Insert the connector to the iPod, iPhone or iPad.

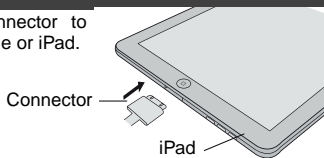

- 2 Place the iPad to the stand for iPad.

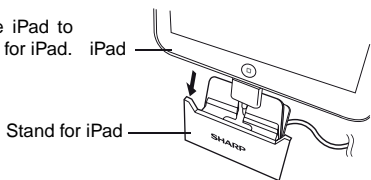

- 3 Connect the iPod, iPhone or iPad to the unit via USB connector.

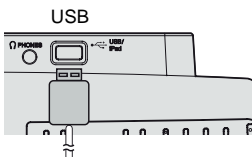

■ iPod, iPhone or iPad playback via USB terminal

- 1 Press the ON/STAND-BY button to turn the power on.
- 2 Press the CD/USB button on the remote control or FUNCTION button repeatedly on the main unit to select USB function.
- 3 Connect iPod, iPhone or iPad to the unit. "USB/iPod" will appear.

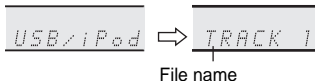

- 4 Press the ►/|| (USB ►/||) button to start playback.

Note:

Stop button (■) is invalid during iPod, iPhone or iPad playback.

■ iPhone playback

- Sound will only switch from iPhone to the main unit after authentication process is completed in approximately 10 seconds.
- Incoming calls will pause the playback.
- Once the calls are answered, the conversation can only be heard through the built-in iPhone speaker. Turn on the iPhone speaker or undock the iPhone to start conversation.

■ iPod and iPhone connection (Dock only)

Caution:

Unplug all accessories from the iPod or iPhone before inserting it into the dock.

Note:

Docking station is not recommended for iPad connection.

- 1 Open the docking station for iPod and iPhone by pulling up the cover.

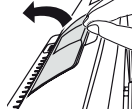

- 2 Dock your iPod or iPhone into the unit.

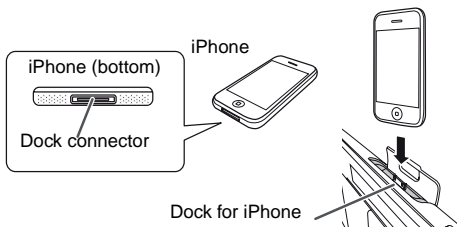

Listening to the iPod, iPhone or iPad (continued)

For iPod nano or iPod touch :

For additional support, apply dock spacer (supplied) as shown.

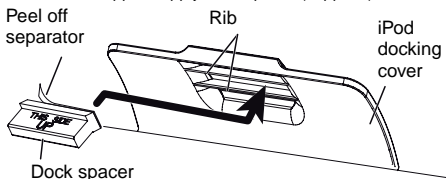

- 1 Peel off the double sided tape separator.
- 2 Place the spacer between the two ribs of the iPod docking cover as shown.

■ iPod or iPhone playback

- 1 Press the ON/STAND-BY button to turn the power on.
- 2 Press the iPod button on the remote control or FUNCTION button repeatedly on the main unit to select iPod function.
- 3 Insert iPod or iPhone unit into the dock of main unit. "DOCK OK" will appear.
- 4 Press the ►/|| (iPod ►/||) button to start playback.

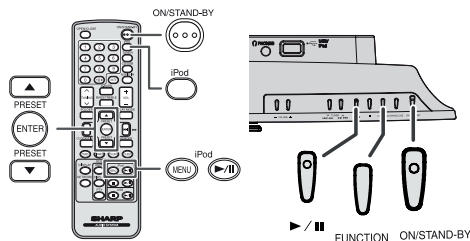

■ Navigating the iPod, iPhone or iPad menus

- 1 Press the iPod MENU button to view the menu on iPod, iPhone or iPad unit. Press it again to go back to previous menu.
- 2 Use the PRESET (▼ or ▲) button to select an item on the menu and then press ENTER button.

Note:

When navigating the iPod, iPhone or iPad menu with remote control, do not operate any of the buttons on the iPod or iPhone unit. The volume level is adjusted by pressing the VOL (+ or -) button on the main unit or the remote control. Adjusting the volume on the iPod, iPhone or iPad units give no effect.

iPod, iPhone and iPad operations:

The operations described below depend on the generation iPod, iPhone and iPad you are using.

System on operation:

When the main unit is powered on, the iPod, iPhone or iPad units will automatically power on when docked or connected in the unit.

System off (stand-by operation):

When the main unit is turned to stand-by mode, the docked iPod, iPhone or connected iPad unit will automatically turn to stand-by mode.

■ To disconnect iPod, iPhone or iPad

Simply remove the iPod or iPhone from the docking station or iPad connector from USB terminal. It is safe to do so even during playback.

Caution:

- Unplug all accessories for the iPod or iPhone before inserting it into the docking station.
- Stop button (■) at main unit is invalid during iPod function.

■ Various iPod, iPhone and iPad functions

Function	Main unit	Remote control		Operation
	Dock/USB	Dock	USB	
Play		iPod	USB	Press in the pause mode.
Pause				Press in the playback mode.
Track up/down				Press in the playback or pause mode. If you press the button in the pause mode, press the ►/ button to start the desired track.
Fast forward/reverse				Press and hold down in the playback mode. Release the button to resume playback.
Repeat	—			Press to toggle repeat mode.
Shuffle	—			Press and hold to toggle shuffle mode.
Menu	—	iPod		Press to view the iPod menu during iPod function.
Enter	—			Press to confirm the selection.
Cursor Up/Down	—		PRESET	Press to select the iPod menu.

Listening to a CD or MP3/WMA disc

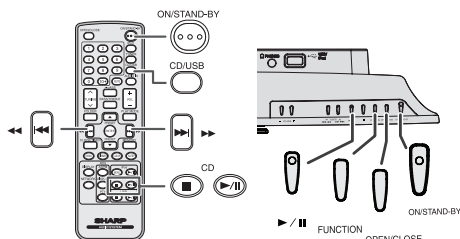

This system can play back a standard CD, CD-R/RW in the CD format and CD-R/RW with MP3 or WMA files, but cannot record on them. Some audio CD-R and CD-RW discs may not be playable due to the state of the disc or the device that was used for recording.

MP3:

MP3 is a form of compression. It is an acronym which stands for MPEG Audio Layer 3. MP3 is a type of audio code which is processed by significant compression from the original audio source with very little loss in sound quality.

- This system supports MPEG 1 Layer 3 and VBR files.
- During VBR file playback, time counter in the display will differ from its actual playback time.
- Bitrate which is supported by MP3 is 32 ~ 320 kbps.

WMA:

WMA files are Advanced System Format files that include audio files which are compressed with Windows Media Audio codec. WMA is developed by Microsoft as an audio format file for Windows Media Player.

- "MP3" and "WMA" indicator will light up after the unit reads information on an MP3 or WMA disc.
- Bitrate which is supported by WMA is 64 ~ 160 kbps.

Disc playback

- 1 Press the ON/STAND-BY button to turn the power on.
- 2 Press the CD/USB button on the remote control or FUNCTION button repeatedly on the main unit to select CD function.
- 3 Press the OPEN/CLOSE button to open the disc compartment.
- 4 Place the disc in the disc compartment, label side front.

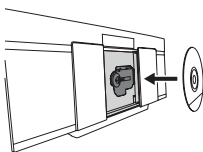

- 5 Press the OPEN/CLOSE button to close the disc compartment.
- 6 Press the ►/|| (CD ►/||) button to start playback. After the last track is played, the unit will stop automatically.

Caution:

- Do not place two discs in the disc compartment.
- Do not play discs of special shapes (heart, octagon, etc). It may cause malfunctions.
- Do not push the disc compartment while it is moving.
- If the power fails while the compartment is open, wait until the power is restored.
- If TV or radio interference occurs during CD operation, move the unit away from the TV or radio.
- Be sure to place 8 cm (3") disc in the middle of the disc compartment.
- Due to the structure of the disc information, it takes longer to read an MP3/WMA disc than a normal CD (approximately 20 to 90 seconds).

Notes for CD or MP3/WMA disc:

- When the end of the last track is reached during fast forward, "END" will appear on the display and CD operation will be paused. When the beginning of the first track is reached during fast reverse, the unit will enter the playback mode (only for CD).
- Rewritable multi-session discs with unfinished writing, can still be played.

Various disc functions

Function	Main unit	Remote control	Operation
Play 		CD 	Press in the stop mode.
Pause 			Press in the playback mode. Press the ►/ button to resume playback from the paused point.
Stop 		CD 	Press in the playback mode.
Track up/down			Press in the playback or stop mode. If you press the button in the stop mode, press the ►/ button to start the desired track.
Fast forward/reverse			Press and hold down in the playback mode. Release the button to resume playback.

Advanced CD or MP3/WMA disc playback

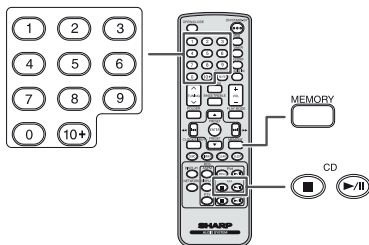

Direct track search

By using the Numeric buttons, the desired tracks on the current disc can be played.

Use the Numeric buttons on the remote control to select the desired track while playing the selected disc.

- The Numeric buttons allow you to select up to number 9.
- When selecting number 10 or higher, use the "10+" button.

Advanced CD or MP3/WMA disc playback (continued)

A. For example, to choose 13

- 1 Press the "10+" button once.
- 2 Press the "1" button.
- 3 Press the "3" button.



Selected track number

B. For example, to choose 130

- 1 Press the "10+" button twice.
- 2 Press the "1" button.
- 3 Press the "3" button.
- 4 Press the "0" button.

Notes:

- A track number higher than the number of tracks on the disc cannot be selected.
- During random play, direct search is not possible.

To stop playback:

Press the (CD) button.

Repeat play

Repeat play can play one track, all tracks or a programmed sequence continuously.

To repeat one track:

Press the PLAY MODE button repeatedly until "Repeat One" appears. Press the (CD) button.

To repeat all tracks:

Press the PLAY MODE button repeatedly until "Repeat All" appears. Press the (CD) button.

To repeat desired tracks:

Perform steps 1 - 5 in "Programmed play" section on this page 12 and then press the PLAY MODE button repeatedly until "Repeat All" appears.

To cancel repeat play:

Press the PLAY MODE button repeatedly until "Normal" appears and "" disappears.



Caution:

After performing repeat play, be sure to press the (CD) button. Otherwise, the disc will play continuously.

Random play (shuffle)

The tracks on the disc can be played in random order automatically.

To random play all tracks:

Press and hold the PLAY MODE button on the remote control until "Random" appears. Press the (CD) button.

To cancel random play:

Press the PLAY MODE button again. "RDM" indicator will disappear.



Notes:

- If you press the button during random play, you can move to the track selected next by the random operation. On the other hand, the button does not allow you to move to the previous track. The beginning of the track being played will be located.
- In random play, the unit will select and play tracks automatically. (You cannot select the order of the tracks.)

Programmed play (CD)

You can choose up to 32 selections for playback in the order you like.

- 1 While in the stop mode, press the MEMORY button on the remote control to enter the programming save mode.



- 2 Press the Numeric buttons on the remote control to select the desired track.

Note: To select track number 10 or higher, refer 'Direct track search' on page 11.



Selected track number

- 3 Repeat step 2 for other tracks. Up to 32 tracks can be programmed. If you want to check the programmed tracks, press the MEMORY button repeatedly. If you make a mistake, the programmed tracks can be cleared by pressing the CLEAR button.

- 4 Press the (CD) button to start playback.

Programmed play (MP3/WMA)

- 1 While in the stop mode, press the MEMORY button to enter the programming save mode.



- 2 Press the PRESET (or) button on the remote control to select the desired folder.



Then press Numeric buttons on the remote control to select the desired tracks.

Note: To select track number 10 or higher, refer 'Direct track search' on page 11.



- 3 Repeat step 2 for other folder/tracks. Up to 32 tracks can be programmed.

- 4 Press the (CD) button to start playback.

To cancel the programmed play mode:

During programmed stop mode, press the (CD) button. The display will show "Memory Clear" and all the programmed contents will be cleared.

Adding tracks to the programme:

If a programme has been previously stored, the "MEM" indicator will be displayed. Press the MEMORY button. Then follow steps 2 to add tracks.

Notes:

- When the disc compartment is opened, the programme is automatically cancelled.
- If you press the ON/STAND-BY button to enter the stand-by mode or change the function from CD to another, the programmed selections will be cleared.
- During the programme operation, random play is not possible.

MP3/WMA folder mode (only for MP3/WMA files)

To play back MP3/WMA (Windows Media Audio) file

There are many music sites on the internet that you can download MP3/WMA (Windows Media Audio) music files. Follow the instructions from the website on how to download the music files. You can then play back these downloaded music files by burning them to a CD-R/RW disc.

- Your downloaded song/files are for personal use only. Any other usage of the song without owner's permission, is against the law.

About folder playback order

If MP3/WMA files are recorded in several folders, a folder number will be set to each folder automatically.

These folders can be selected by the FOLDER button on the remote control. If there is no supported file formats inside the selected folder, the folder is skipped and the next folder will be selected.

Example: How to set folder number if MP3/WMA format files are recorded as below figure.

- ROOT folder is set as folder 1.
 - As for folders inside ROOT folder (Folder A and Folder B), the folder which is recorded earlier on the disc will be set as folder 2 and folder 6.
 - As for folder inside Folder A (Folder C and Folder D), the folder which is recorded earlier on the disc will be set as folder 3 and folder 4.
 - Folder E that is inside Folder D will be set as folder 5.
- The folder and file order information which is recorded on the disc depends on the writing software. There maybe possibilities that this unit will playback the files not according to our expected playback order.
 - For CD MP3/WMA, 999 numbers of folders and files inclusive of the folders which have non playable files can be read.

Folder mode on/off can be operated by the FOLDER button on the remote control. Files that are played when folder mode is set to the on position, may differ from those played back when folder mode is turned off.

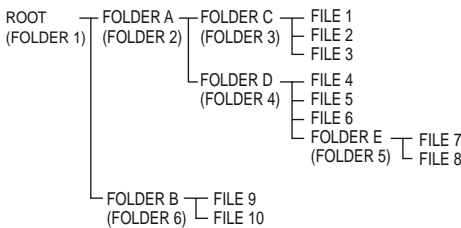

Procedure to playback MP3/WMA disc with folder mode on

To play back CD-R/RW.

- Press the CD button, and load an MP3/WMA disc. Press the FOLDER button and disc info will be displayed.

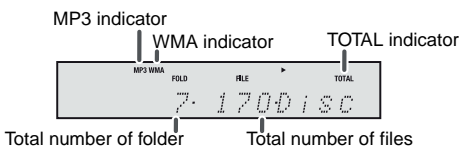

- Press the PRESET (▼ or ▲) button to select desired playback folder. (Folder mode on)

FOLDER indicator

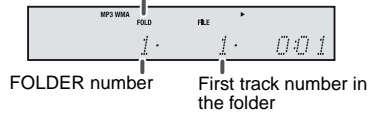

- Select desired file to be played back by pressing the ◀◀ or ▶▶ button.
- Press the ▶/|| (CD ▶/||) button. Playback will start and file name will be displayed.
 - Title, Artist and Album name are displayed if they are recorded on the disc.
 - In case of playback with the folder mode on, press the PRESET (▼ or ▲) button, and the folder can be selected even though it is in playback/pause mode. It will continue playback/pause mode in the 1st track of the selected folder.
 - Display content can be changed by pressing the DISPLAY button.

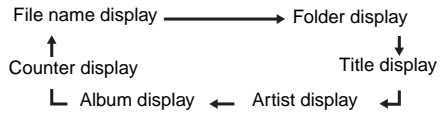

Note:

If "Not Support" is displayed, it means "Copyright protected WMA file" or "Not supported playback file" is selected.

Listening to USB mass storage device/MP3 player

Caution:

At USB mode, once the iPod or iPhone is docked onto the unit, the iPod or iPhone will automatically start charging. 'iPod DOCK Charge Mode' will be displayed. In order to listen to any USB mass storage device / MP3 player, the iPod or iPhone must be removed from the docking station.

Notes:

- Remove the USB terminal cover before use. Keep it away from children as it may be swallowed.
- Cover the USB terminal if it is not used for a long period of time to prevent dust or rust.

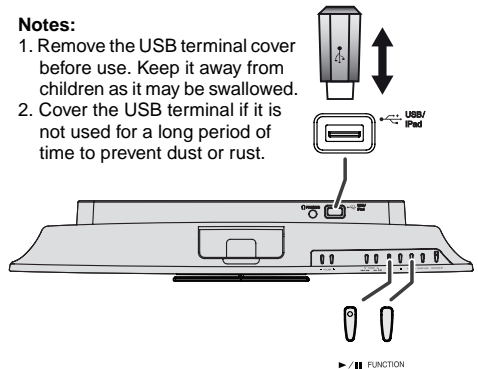

Listening to USB mass storage device/MP3 player (continued)

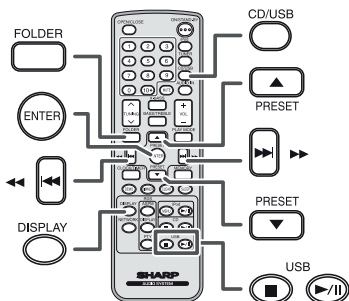

Note:

This product is not compatible with MTP and AAC file systems from USB mass storage device or MP3 player.

To play back USB/MP3 player with folder mode off

- 1 Press the CD/USB button on the remote control or FUNCTION button repeatedly on main unit to select USB function. Connect the USB memory device that has MP3/WMA format files on the unit. When the USB memory is connected to the main unit, the device information will be displayed.
- 2 Select desired file to be played back by pressing the ◀◀ or ▶▶ button.
- 3 Press the ▶/|| (USB ▶/||) button. Playback will start and the file name will be displayed.
 - Title, Artist and Album name are displayed if they are recorded in the USB memory device.
 - Display content can be changed by pressing the DISPLAY button.

Note:

To pause playback:

Press the ▶/|| (USB ▶/||) button.

To play back USB/MP3 player with folder mode on

- 1 Press the CD/USB button on the remote control or FUNCTION button repeatedly on main unit to select USB function. Connect the USB memory device that has MP3/WMA format files on the unit. When the USB memory is connected to the main unit, the device information will be displayed.
- 2 Press the FOLDER button, and press the PRESET (▼ or ▲) button to select desired playback folder. To start playback with folder mode on, go to step 4. To change the playback folder, press the PRESET (▼ or ▲) button to select another folder.
- 3 Select desired file to be played back by pressing the ◀◀ or ▶▶ button.
- 4 Press the ▶/|| (USB ▶/||) button. Playback will start and the file name will be displayed.
 - Title, Artist and Album name are displayed if they are recorded in the USB memory device.
 - Display content can be changed by pressing the DISPLAY button.

To remove USB memory device

- 1 Press the ■ (USB ■) button to stop playback.
- 2 Disconnect USB memory device from the USB terminal.

Notes:

- SHARP will not be held liable for the loss of data while the USB memory device is connected to the audio system.
- Files compressed in MP3 and/or WMA format can be played back when connected to the USB terminal.
- This USB memory's format supports FAT 16 or FAT 32.
- SHARP does not guarantee that all USB memory devices will work on this audio system.
- USB cable is not recommended for use in this audio system to connect to USB memory device. Use of the USB cable will affect the performance of this audio system. iPod, iPhone and iPad is not prone to this condition.
- This USB memory cannot be operated via USB hub.
- The USB terminal in this unit is not intended for a PC connection but is used for music streaming with a USB memory device.
- External HDD-storage cannot be played back via USB terminal.
- If the data inside the USB memory is large, it may take longer time for the data to be read.
- This product can play WMA and MP3 files. It will automatically detect the file type being played. If unplayable file is played on this product, "Not Support" is indicated and the file will be automatically skipped. This will take a few seconds. If abnormal indications appear on the display due to the unspecified file, turn off the unit and then turn it on again.
- This product relates to USB mass storage devices and MP3 players. It may however face some irregularities due to various unforeseen reasons from some devices. Should this happen, turn off the unit and then turn it on again.
- During CD function, MP3 player will not be charging.

Advanced USB playback

The following functions are the same as CD operations:

	Page
Direct track search	11
Repeat play	12
Random play	12
Programmed play (MP3/WMA)	12

Note:

If USB memory device is not connected, "USB No Media" will be shown on the display.

Notes:

- This unit only supports "MPEG-1 Audio Layer-3" format. (Sampling Frequency is 32, 44.1, 48kHz)
- Playback order for MP3 files may differ depending on the writing software used during file download.
- Bitrate which is supported by MP3 is 32~320 kbps, WMA is 64~160 kbps.

Advanced USB playback (continued)

- For MP3/WMA files, please put “.MP3” “.WMA” extension. Files cannot be played back if there is no MP3/WMA extension.
- Playlists are not supported on this unit.
- This unit can display Folder Name or File Name up to 32 characters.
- Maximum total number of MP3/WMA files is 65025.
- Total number of folders read is 999 including folder with non-playable file. However, the display shows only folder with MP3 files.
- The display playback time may not be displayed correctly when playing back a variable bitrate file.
- The ID3TAG information supported are TITLE, ARTIST and ALBUM only. Title name, artist name and album name can be displayed by pressing the DISPLAY button during file playback or pause mode.
- WMA meta tag also supports title, artist and album name which are recorded in WMA files. Copyright protected WMA files cannot be played back.

Listening to the radio

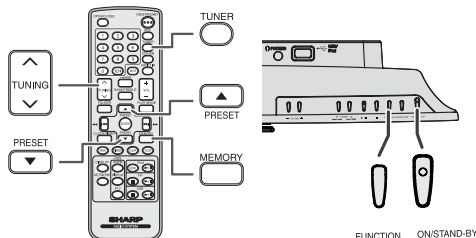

Tuning

- 1 Press the ON/STAND-BY button to turn the power on.
- 2 Press the FUNCTION button on the main unit or TUNER button on the remote control repeatedly to select FM Stereo, FM Mono or AM.
- 3 Press the TUNING (∨ or ∧) button on the remote control to tune in to the desired station.

Manual tuning:

Press the TUNING (∨ or ∧) button repeatedly to tune in to the desired station.

Auto tuning:

When the TUNING (∨ or ∧) button is pressed for more than 0.5 seconds, scanning will start automatically and the tuner will stop at the first receivable broadcast station.

Notes:

- When radio interference occurs, auto scan tuning may stop automatically at that point.
- Auto scan tuning will skip weak signal stations.
- To stop the auto tuning, press the TUNING (∨ or ∧) button again.
- When an RDS (Radio Data System) station is tuned in, the frequency will be displayed first, and then the RDS indicator will light up. Finally, the station name will appear.
- Full auto tuning can be achieved for RDS stations “ASPM”, see page 16.

To receive an FM stereo transmission:

- Press the TUNER button to select stereo mode and “ST” indicator will be displayed. “>••” and “••” will appear when an FM broadcast is in stereo.
- If the FM reception is weak, press the TUNER button to extinguish the “ST” indicator. The reception changes to monaural, and the sound becomes clearer.

Memorising a station

You can store 40 AM and FM stations in memory and recall them at the push of a button. (Preset tuning)

- 1 Perform steps 2 - 3 in “Tuning”.

- 2 Press the MEMORY button.



- 3 Within 30 seconds, press the PRESET (∨ or ∧) button to select the preset channel number. Store the stations in memory, in order, starting with preset channel 1.

- 4 Within 30 seconds, press the MEMORY button to store that station in memory. If the “MEMORY” and preset number indicators disappear before the station is memorised, repeat the operation from step 2.

- 5 Repeat steps 1 - 4 to set other stations, or to change a preset station. When a new station is stored in the memory, the station previously memorised for that preset channel number will be erased.

Note:

The backup function protects the memorised stations for a few hours should there be a power failure or the AC power lead becomes disconnected.

To recall a memorised station

Press the PRESET (∨ or ∧) button for less than 0.5 seconds to select the desired station.

To scan the preset stations

The stations saved in the memory can be scanned automatically. (Preset memory scan)

- 1 Press the PRESET (∨ or ∧) button for more than 0.5 seconds. The preset number will flash and the programmed stations will be tuned in sequentially, for 5 seconds each.
- 2 Press the PRESET (∨ or ∧) button again when the desired station is located.

To erase entire preset memory

- 1 Press the ON/STAND-BY button to enter the stand-by mode.
- 2 While pressing down the <<< button, press the ON/STAND-BY button until “Tuner Clear” appears.



Using the Radio Data System (RDS)

RDS is a broadcasting service which a growing number of FM stations provide. These FM stations send additional signals along with their regular programme signals. They send their station names, and information about the type of programme such as sport, music, etc.

When tuned to an RDS station, "RDS" and the station name will be displayed.

"TP" (Traffic Programme) will appear on the display when the received broadcast carries traffic information, and "TA" (Traffic Announcement) will appear while a traffic information is on air.

"PTY" (Dynamic PTY Indicator) will appear while the Dynamic PTY station is received.



You can control the RDS by using the buttons on the remote control only.

Information provided by RDS

Each time the RDS DISPLAY button is pressed, the display will switch as follows:

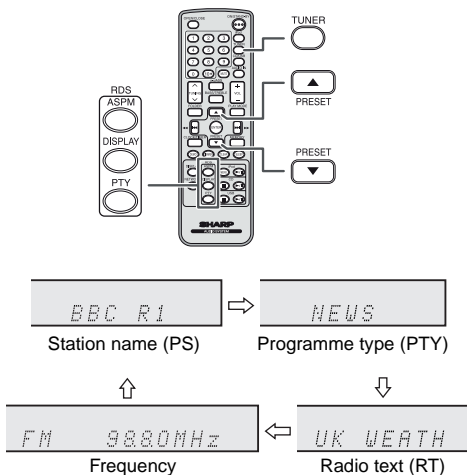

When tuning in to a station other than an RDS station or to an RDS station which sends weak signal, the display will change in the following order:

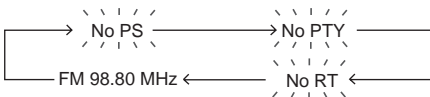

Using the Auto Station Programme Memory (ASPM)

While in the ASPM operation mode, the tuner will automatically search for new RDS stations. Up to 40 stations can be stored.

If you have already stored some stations in memory, the number of new stations you can store will be less.

1 Press the TUNER button on the remote control or FUNCTION button repeatedly on the main unit to select TUNER function.

2 Press and hold down the RDS ASPM button on the remote control.

1 After "ASPM" has flashed for about 4 seconds, scanning will start (87.50 - 108.00 MHz).

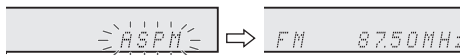

2 When an RDS station is found, "RDS" will appear for a short time and the station will be stored in memory.



3 After scanning, the number of stations stored in memory will be displayed for 4 seconds, and then "END" will appear for 4 seconds.



To stop the ASPM operation before it is complete:

Press the RDS ASPM button while it is scanning for stations. The stations which are already stored in memory will be kept there.

Notes:

- If the same station is broadcasting on different frequencies, the strongest frequency will be stored in memory.
- Any station which has the same frequency as the one stored in memory will not be stored.
- If 40 stations have already been stored in memory, the scan will be aborted. If you want to redo the ASPM operation, erase the preset memory.
- If no station has been stored in memory, "END" will appear for about 4 seconds.
- If the RDS signals are very weak, station names may not be stored in memory.
- The same station name can be stored in different channels.
- In a certain area or during certain time periods, the station names may temporarily be different.

Using the Radio Data System (RDS) (continued)

■ Notes for RDS operation

If any of the following events occur, it does not mean that the unit is faulty:

- "PS", "No PS" and a station name appear alternately, and the unit does not operate properly.
- If a particular station is not broadcasting properly or a station is conducting tests, the RDS reception function may not work properly.
- When you receive an RDS station whose signal is too weak, information like the station name may not be displayed.
- "No PS", "No PTY" or "No RT" will flash for about 5 seconds, and then the frequency will be displayed.

Notes for radio text:

- The first 14 characters of the radio text will appear for 4 seconds and then they will scroll across the display.
- If you tune in to an RDS station which is not broadcasting any radio text, "No RT" will be displayed when you switch to the radio text position.
- While radio text data is received or when the text contents change, "RT" will be displayed.

■ To recall stations in memory

To specify programmed types and select stations (PTY search):

You can search a station by specifying the programme type (news, sports, traffic programme, etc. ... see pages 17 - 18) from the stations in memory.

- 1 Press the TUNER button on the remote control or FUNCTION button repeatedly on the main unit to select TUNER function.
- 2 Press the RDS PTY button on the remote control.



"SELECT" and "PTY TI" will appear alternately for about 6 seconds.

- 3 Within 6 seconds, press the PRESET (▼ or ▲) button to select the programme type.



Each time the button is pressed, the programme type will appear. If the button is held down for more than 0.5 seconds, the programme type will appear continuously.

- 4 While the selected programme type is flashing (within 6 seconds), press the RDS PTY button again.



After the selected programme type has been lit for 2 seconds, "SEARCH" will appear, and the search operation will start.

Notes:

- If the display has stopped flashing, start again from step 2. If the unit finds a desired programme type, the corresponding channel number will lit for about 8 seconds, and then the station name will remain lit.
- If you want to listen to the same programme type of another station, press the RDS PTY button while the channel number or station name is flashing. The unit will look for the next station.
- If no station can be found, "Not Found" will appear for 4 seconds.

If you select the traffic programme:

If you select the traffic programme (TP) in step 3, "TP" will appear.

(This does not mean that you can listen to the traffic information at that time.)

When the traffic information is broadcast, "TA" will appear.

Descriptions of the PTY (Programme Type) codes, TP (Traffic Programme) and TA (Traffic Announcement)

You can search for and receive the following PTY, TP and TA signals.

NEWS	Short accounts of facts, events and publicly expressed views, reportage and actuality.
AFFAIRS	Topical programme expanding or enlarging upon the news, generally in different presentation style or concept, including debate, or analysis.
INFO	Programmes whose purpose is to impart advice in the widest sense.
SPORT	Programme concerned with any aspect of sport.
EDUCATE	Programme intended primarily to educate, of which the formal element is fundamental.
DRAMA	All radio plays and serials.
CULTURE	Programmes concerned with any aspect of national or regional culture, including language, theatre, etc.
SCIENCE	Programmes about the natural sciences and technology.
VARIED	Used for mainly speech-based programmes usually of light-entertainment nature, not covered by other categories. Examples include: quizzes, panel games, personality interviews.
POP M	Commercial music, which would generally be considered to be of current popular appeal, often featuring in current or recent record sales charts.
ROCK M	Contemporary modern music, usually written and performed by young musicians.
EASY M	Current contemporary music considered to be "easy-listening", as opposed to Pop, Rock or Classical, or one of the specialised music styles, Jazz, Folk or Country. Music in this category is often but not always, vocal, and usually of short duration.
LIGHT M	Classical music for general, rather than specialist appreciation. Examples of music in this category are instrumental music, and vocal or choral works.
CLASSICS	Performances of major orchestral works, symphonies, chamber music, etc., and including Grand Opera.
OTHER M	Musical styles not fitting into any of the other categories. Particularly used for specialist music of which Rhythm & Blues and Reggae are examples.
WEATHER	Weather reports and forecasts and meteorological information.
FINANCE	Stock Market reports, commerce, trading, etc.

Using the Radio Data System (RDS) (continued)

CHILDREN	For programmes targeted at a young audience, primarily for entertainment and interest, rather than where the objective is to educate.
SOCIAL	Programmes about people and things that influence them individually or in groups. Includes: sociology, history, geography, psychology and society.
RELIGION	Any aspect of beliefs and faiths, involving a God or Gods, the nature of existence and ethics.
PHONE IN	Involving members of the public expressing their views either by phone or at a public forum.
TRAVEL	Features and programmes concerned with travel to near and far destinations, package tours and travel ideas and opportunities. Not for use for announcements about problems, delays, or roadworks affecting immediate travel where TP/TA should be used.
LEISURE	Programmes concerned with recreational activities in which the listener might participate. Examples include, Gardening, Fishing, Antique collecting, Cooking, Food & Wine, etc.
JAZZ	Polyphonic, syncopated music characterised by improvisation.
COUNTRY	Songs which originate from, or continue the musical tradition of the American Southern States. Characterised by a straightforward melody and narrative story line.
NATION M	Current Popular Music of the Nation or Region in that country's language, as opposed to International "Pop" which is usually US or UK inspired and in English.
OLDIES	Music from the so-called "golden age" of popular music.
FOLK M	Music which has its roots in the musical culture of a particular nation, usually played on acoustic instruments. The narrative or story may be based on historical events or people.
DOCUMENT	Programme concerned with factual matters, presented in an investigative style.
TEST	Broadcast when testing emergency broadcast equipment or receivers.
ALARM!	Emergency announcement made under exceptional circumstances to give warning of events causing danger of a general nature.
NONE	No programme type (receive only).
TP	Broadcasts which carry traffic announcements.
TA	Traffic announcements are being broadcast.

Timer and sleep operation (Remote control only)

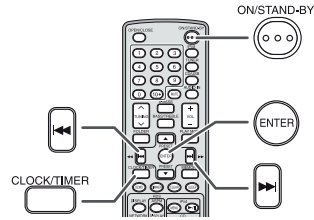

Timer playback:

The unit turns on and plays the desired source (CD, TUNER, USB, iPod, AUDIO IN) at a preset time.

This unit has 2 types of timer: ONCE TIMER and DAILY TIMER.

Once timer:

Once timer play works for one time only at a preset time.

("⊙" indicator).

Daily timer:

Daily timer play works at the same preset time every day that we set. For example, set the timer as a wake-up call every morning.

("DAILY" indicator).

Using the once timer and daily timer in combination:

For example, use the once timer to listen a radio programme, and use the daily timer to wake up.

- 1 Set the daily timer (pages 18 - 19).
- 2 Set the once timer (pages 18 - 19).

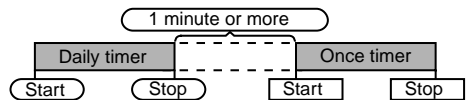

■ Timer playback

Before setting timer:

- Check that the clock is set to the correct time (refer to page 6). If it is not set, you cannot use the timer function.
- For timer playback: Plug in USB or load discs or dock iPod to be played.



- 1 Press the ON/STAND-BY button to turn the power on.
- 2 Press and hold the CLOCK/TIMER button.
- 3 Within 10 seconds, press the ◀ or ▶ button to select "Once" or "Daily", and press the ENTER button.
- 4 Within 10 seconds, press the ◀ or ▶ button to select "Timer Set", and press the ENTER button.
- 5 To select the timer playback source (CD, TUNER, USB, iPod, AUDIO IN), press the ◀ or ▶ button. Press the ENTER button. When you select the tuner, select a station by pressing the ◀ or ▶ button, and then press the ENTER button. If a station has not been programmed, "No Preset" will be displayed and timer setting will be cancelled.
- 6 To adjust the day, press the ◀ or ▶ button and then press the ENTER button.
- 7 Press the ENTER button to adjust the hour. Press the ◀ or ▶ button and then press the ENTER button.

Timer and sleep operation (Remote control only) (continued)

- To adjust the minutes, press the ◀◀ or ▶▶ button and then press the ENTER button.
- Set the time to finish as in steps 7 and 8 above.
- Adjust the volume using the VOLUME control, and then press the ENTER button. Do not turn the volume up too high.
- Press the ON/STAND-BY button to enter the power stand-by mode. The "TIMER" indicator lights up and the unit is ready for timer playback.

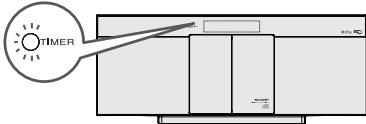

- When the preset time is reached, playback will start. The volume will increase gradually until it reaches the preset volume. The timer indicator will blink during timer playback.
- When the timer end time is reached, the system will enter the power stand-by mode automatically.
Once timer:
The timer will be cancelled.
Daily timer:
The timer operates at the same time every selected day. It will continue until the daily timer setting is cancelled. Cancel the daily timer when it is not in use.

Notes:

- When performing timer playback using another unit connected to the USB terminal or AUDIO IN socket, select "USB" or "AUDIO IN" in step 5.
- This unit will turn on or enter the power stand-by mode automatically. However, the connected unit will not turn on or off. To stop the timer playback, follow step "Cancelling the timer setting" of this page.

Checking the timer setting:

- Turn the power on and press and hold down the CLOCK/TIMER button.
- Within 10 seconds, press the ◀◀ or ▶▶ button to select "Once" or "Daily", and press the ENTER button.
- Within 10 seconds, press the ◀◀ or ▶▶ button to select "Timer Call", and press the ENTER button.

Cancelling the timer setting:

- Turn the power on and press and hold down the CLOCK/TIMER button.
- Within 10 seconds, press the ◀◀ or ▶▶ button to select "Once" or "Daily", and press the ENTER button.
- Within 10 seconds, press the ◀◀ or ▶▶ button to select "Timer Off", and press the ENTER button. Timer will be cancelled (the setting will not be cancelled).

Reusing the memorised timer setting:

The timer setting will be memorised once it is entered. To reuse the same setting, perform the following operations.

- Turn the power on and press and hold down the CLOCK/TIMER button.
- Within 10 seconds, press the ◀◀ or ▶▶ button to select "Once" or "Daily", and press the ENTER button.
- Within 10 seconds, press the ◀◀ or ▶▶ button to select "Timer On", and press the ENTER button.
- Press the ON/STAND-BY button to enter the power stand-by mode.

■ Sleep operation

The radio, compact disc, iPod, USB, Audio In, Network can all be turned off automatically.

- Play back the desired sound source.
- Press the SLEEP button.
- Within 5 seconds, press the Numeric button to set the time. (1 minute ~ 99 minutes)
- "SLEEP" will appear.
- The unit will enter the power stand-by mode automatically after the preset time has elapsed. The volume will be turned down 1 minute before the sleep operation finishes.

To confirm the remaining sleep time:

While "SLEEP" is indicated, press the SLEEP button.

To cancel the sleep operation:

Press the ON/STAND-BY button while "SLEEP" is indicated. To cancel the sleep operation without setting the unit to the stand-by mode, proceed as follows.

- While "SLEEP" is indicated, press the SLEEP button.
- Within 5 seconds, press the "0" button twice until "SLEEP 00" appears.

■ To use timer and sleep operation together

Sleep and timer playback:

For example, you can fall asleep listening to the radio and wake up to CD in the next morning.

- Set the sleep time (see above, steps 1 - 5).
- While the sleep timer is set, set the timer playback (steps 2 - 9, pages 18 - 19).

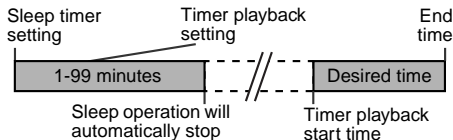

Enhancing your system

The connection lead is not included. Purchase a commercially available lead as shown below.

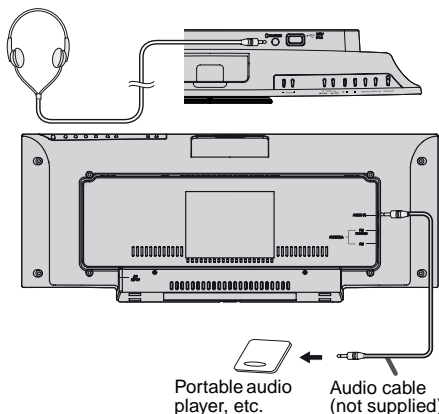

Enhancing your system (continued)

■ Listening to the playback sounds of portable audio player, etc.

- 1 Use a connection lead to connect the portable audio player etc. to the AUDIO IN socket. When using video equipment, connect the audio output to this unit and the video output to a television.
- 2 Press the ON/STAND-BY button to turn the power on.
- 3 Press the AUDIO IN button on the remote control or FUNCTION button repeatedly on main unit to select AUDIO IN function.
- 4 Play the connected equipment. If volume level of the connected device is too high, sound distortion may occur. Should this happen, lower the volume of the connected device. If volume level is too low, increase the volume of the connected device.

Note:

To prevent noise interference, place the unit away from the television.

■ Headphones

- Do not turn the volume on to full at switch on and listen to music at moderate levels. Excessive sound pressure from earphones and headphones can cause hearing loss.
- Before plugging in or unplugging the headphone, reduce the volume.
- Be sure your headphone has a 3.5 mm (1/8") diameter plug and impedance between 16 and 50 ohms. The recommended impedance is 32 ohms.
- Plugging in the headphone disconnects the speakers automatically. Adjust the volume using the VOLUME control.

Troubleshooting chart

Many potential problems can be resolved by the owner without calling a service technician.

If something is wrong with this product, check the following before calling your authorised SHARP dealer or service centre.

■ General

Symptom	Possible cause
● The clock is not set to the correct time.	● Did a power failure occur? Reset the clock. (Refer page 6)
● When a button is pressed, the unit does not respond.	● Set the unit to the power stand-by mode and then turn it back on. ● If the unit still malfunctions, reset it. (Refer page 21)
● No sound is heard.	● Is the volume level set to "Min"? ● Are the headphones connected?

■ iPod, iPhone or iPad

Symptom	Possible cause
● No sound is produced.	● The iPod, iPhone or iPad is not playing. ● The iPod, iPhone or iPad is not properly connected to the unit. ● Is the AC power lead of the unit plugged in?
● iPod, iPhone or iPad will not charge.	● The iPod, iPhone or iPad is not making full contact with the connector. ● Using iPod (3 rd generation). ● The iPod or iPhone is not supported. Refer to page 9 for compatible models.
● "This accessory is not made to work with iPhone" or "This accessory is not supported by iPhone" appears on iPhone screen.	● The iPhone battery is low. Please charge the iPhone. ● iPhone is not properly docked.

■ USB

Symptom	Possible cause
● Device cannot be detected.	● Is there any MP3/WMA file available? ● Is the device properly connected? ● Is it an MTP device? ● Does the device contain AAC file only?
● Playback does not start.	● Is it a copyright protected WMA file? ● Is it a false MP3 file?
● Wrong time display. ● Wrong file name display.	● Is Variable Bitrate file being played back? ● Is the File Name written in Chinese or Japanese characters?

■ CD player

Symptom	Possible cause
● Playback does not start. ● Playback stops in the middle or is not performed properly.	● Is the disc loaded face down? ● Does the disc satisfy the standards? ● Is the disc distorted or scratched?
● Playback sounds are skipped, or stopped in the middle of a track.	● Is the unit located near excessive vibrations? ● Is the disc very dirty? ● Has condensation formed inside the unit?

■ Tuner

Symptom	Possible cause
● The radio makes unusual noises continuously.	● Is the unit placed near the TV or computer? ● Is the FM/AM aerial placed properly? Move the aerial away from the AC power lead if it is located nearby.

Troubleshooting chart (continued)

Wi-Fi connection

Symptom	Possible cause
<ul style="list-style-type: none"> ● Wi-Fi network connection failed. 	<ul style="list-style-type: none"> ● Is your router Wi-Fi certified? ● WPS-Pin and WPS-PBC routers is not supported by this unit. ● Is the SSID broadcast on the Wi-Fi router enabled? ● Avoid using Wi-Fi channel which is much overlapped by the nearby Wi-Fi network. ● Is the unit placed near a potential source of interference which may affect Wi-Fi signal, such as microwave ovens? ● Is your PC using a Wi-Fi network? Ethernet connection for AirPlay / DLNA network setup is not possible. ● Do not use special characters like '%', '#', '*' to rename your router or the AirPlay device in the setting menu.

AirPlay / DLNA

Symptom	Possible cause
<ul style="list-style-type: none"> ● No AirPlay icon on Apple AirPlay device or iTunes in my PC. 	<ul style="list-style-type: none"> ● Is the unit joined to the AirPlay network? ● Is the Bonjour service in your PC enabled before you open iTunes?
<ul style="list-style-type: none"> ● AirPlay connection failed with Mac or PC. 	<ul style="list-style-type: none"> ● Firewalls and security software must be disabled. ● Is your network speed fast enough? Other devices connected to your home router might need to be turned off.
<ul style="list-style-type: none"> ● Breaking of music streaming. 	<ul style="list-style-type: none"> ● Restart your Apple AirPlay / DLNA device or this unit. ● Stop any internet content browsing via your home router. ● Enable the Auto Channel Scan Option on the Wi-Fi router if available. ● Enable the Wireless Intelligent Stream Handling (WISH) option on the Wi-Fi router if available. ● Enable the Quality of Service (QoS) option on the Wi-Fi router if available. ● Other home routers must be turned off.

Remote control

Symptom	Possible cause
<ul style="list-style-type: none"> ● The remote control does not operate. 	<ul style="list-style-type: none"> ● Is the AC power lead of the unit plugged in? ● Is the battery polarity correct? ● Is the battery dead? ● Is the distance or angle incorrect? ● Does the remote control sensor receive strong light?

Condensation

Sudden temperature changes, storage or operation in an extremely humid environment may cause condensation inside the cabinet (CD pickup, etc.) or on the transmitter on the remote control. Condensation can cause the unit to malfunction. If this happens, leave the power on with no disc in the unit until normal playback is possible (about 1 hour). Wipe off any condensation on the transmitter with a soft cloth before operating the unit.

If problem occurs

When this product is subjected to strong external interference (mechanical shock, excessive static electricity, abnormal supply voltage due to lightning, etc.) or if it is operated incorrectly, it may malfunction.

If such a problem occurs, do the following:

- 1 Set the unit to the stand-by mode and turn the power on again.
- 2 If the unit is not restored in the previous operation, unplug and plug in the unit again, and then turn the power on.

Note:

If neither operation above restores the unit, clear all the memory by resetting it.

Factory reset, clearing all memory

- 1 Press the ON/STAND-BY button to enter the power stand-by mode.
- 2 While pressing down the OPEN/CLOSE button, press the ON/STAND-BY button until "Clear All" appears.



Caution:

This operation will erase all data stored in memory including clock, timer settings and tuner preset.

Network reset

If the Network function operates incorrectly, do the reset operation as below:

During Network function, press and hold CLEAR button until "Network Clear" appears.

This operation will erase the current Wi-Fi setting.

Troubleshooting chart (continued)

Before transporting the unit

Remove the iPod, iPhone, iPad, USB memory device and disc from the unit. Then, set the unit to the power stand-by mode. Carrying the unit with iPod, iPhone, iPad or USB memory device left connected or discs left inside might damage the unit.

Care of compact discs

Compact discs are fairly resistant to damage, however mistracking can occur due to an accumulation of dirt on the disc surface. Follow the guidelines below for maximum enjoyment from your CD collection and player.

- Do not write on either side of the disc, particularly the non-label side from which signals are read. Do not mark this surface.
- Keep your discs away from direct sunlight, heat, and excessive moisture.
- Always hold the CDs by the edges. Fingerprints, dirt, or water on the CDs can cause noise or mistracking. If a CD is dirty or does not play properly, clean it with a soft, dry cloth, wiping straight out from the centre, along the radius.

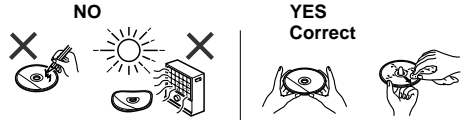

Maintenance

Cleaning the cabinet

Periodically wipe the cabinet with a soft cloth and a diluted soap solution, then with a dry cloth.

Caution:

- Do not use chemicals for cleaning (petrol, paint thinner, etc.). It may damage the cabinet.
- Do not apply oil to the inside of the unit. It may cause malfunctions.

Specifications

As part of our policy of continuous improvement, SHARP reserves the right to make design and specification changes for product improvement without prior notice. The performance specification figures indicated are nominal values of production units. There may be some deviations from these values in individual units.

General

Power source	AC 220 - 240 V ~ 50/60 Hz
Power consumption	Power on: 26 W Power stand-by: 0.4 W (*)
Speaker	1-way speaker system Speaker: 6.5 cm (2-1/2")
Speaker maximum input power	50 W/channel
Speaker rated input power	25 W/channel
Dimensions	Width: 475 mm (18 - 11/16") Height: 191 mm (7 - 1/2") Depth: 83 mm (3 - 1/4")
Weight	2.7 kg (5.9 lbs.)

(*) This power consumption value is obtained when the demonstration mode is cancelled in the power stand-by mode. Refer to page 4 to cancel the demonstration mode.

Amplifier

Output power	PMPO: 100 W MPO: 50 W (25 W + 25 W) (10% T.H.D.) RMS: 50 W (25 W + 25 W) (10% T.H.D.) RMS: 40 W (20 W + 20 W) (1% T.H.D.)
Output terminals	Headphones: 16 ohms (recommended: 32 ohms)
Input terminals	Audio In (audio signal): 500 mV/47 k ohms

CD player

Type	Single disc multi-play compact disc player
Signal readout	Non-contact, 3-beam semiconductor laser pickup
D/A converter	Multi bit D/A converter
Frequency response	20 - 20,000 Hz
Dynamic range	90 dB (1 kHz)

USB (MP3 / WMA)

USB host interface	<ul style="list-style-type: none"> ● Complies with USB 1.1 (Full Speed)/2.0 Mass Storage Class. ● Support Bulk only and CBI protocol.
Support file	<ul style="list-style-type: none"> ● MPEG 1 Layer 3 ● WMA (Non DRM)
Bitrate support	<ul style="list-style-type: none"> ● MP3 (32 ~ 320 kbps) ● WMA (64 ~ 160 kbps)
Other	<ul style="list-style-type: none"> ● Maximum total number of MP3/WMA files is 65025. ● Maximum total number of folders is 999 INCLUSIVE of root directory. ● The ID3TAG information supported are TITLE, ARTIST and ALBUM only. ● Supports ID3TAG version 1 and version 2.
File system support	<ul style="list-style-type: none"> ● Support USB devices with Microsoft Windows/DOS/FAT 12/FAT 16/ FAT 32. ● 2 kbyte block length for sector.

Tuner

Frequency range	FM: 87.5 - 108 MHz AM: 522 - 1,620 kHz
Preset	40 (FM and AM station)

SHARP®

SHARP ELECTRONICS (Europe) GmbH

Sonninstraße 3, D-20097 Hamburg

SHARP CORPORATION



TINSZB208AWZZ

12C R MW ②