



G-Technology™

G | DRIVE®

Professional External Hard Drive



Welcome to G-DRIVE**Table of Contents****Safety & General Use**

Safety Precautions.....	4
Backup Your Data	5

About Your G-DRIVE

Introduction	7
What's in the Box	8
System Requirements.....	9
Overview of the Drive	9

Using Your Drive on Mac

Easy Installation for Mac	11
Optimize Performance	11
Use with Time Machine.....	12
Disconnect the Drive.....	14

Maintenance for Your Drive

Initialize Drive for Mac	16
Restore the Drive Icon	19
Reformat with Partitions.....	21

Using Your Drive on Windows

Windows Use.....	26
Cross Platform Use	27

Support & Warranty

Technical Support	31
Limited Warranty	32
Copyright.....	34



Safety & General Use

- Safety Precautions p.4
- Backup Your Data p.5



G-Technology™

Safety Precautions

G-DRIVE warranty may be void as a result of the failure to respect the precautions listed here. If you detect a problem with your drive, please contact our [Technical Support department](#).

Please read our [Limited Warranty](#).

- **Servicing:** Your drive contains no user-serviceable parts. If it appears to be malfunctioning, have it inspected by a qualified G-Technology Technical Support representative.
- **Moisture:** Place the device away from moisture or liquids. To reduce the risk of damage, do not expose this drive to rain or moisture. Do not use it in damp or wet conditions. Never place objects containing liquids on the drive as they may spill into its openings.
- **Ventilation:** Place the device in a vented area. The drive should never be placed near or over a radiator or heat source.
- **Temperature:** Do not expose this drive to temperatures outside the range of 5°C to 35°C (41°F to 95°F); or to operational humidity beyond 5-80%, non-condensing, or non-operating humidity beyond 10-90%, non-condensing. Avoid placing your drive near a source of heat, or exposing it to sunlight (even through a window), or in an environment that is too cold or humid.
- **Physical Damage:** Do not place heavy objects on the drive. Never use excessive force on your drive.

Backup Your Data

The disk drive contained in your G-DRIVE device is a delicate electronic instrument and is susceptible to damage due to excessive physical shock. Under no circumstances will G-Technology be held liable for the recovery or restoration of lost data. Any loss, corruption or destruction of data while using a G-Technology drive is the sole responsibility of the user.

Make two backups

To help prevent the loss of your data, we highly recommend that you keep TWO copies of your data in separate storage locations. Keep one copy on your G-Technology drive. Keep a second copy on your internal hard drive, another G-Technology drive, or a form of removable storage media.



About Your G-DRIVE

- Introduction p.7
- What's in the Box p.8
- System Requirements p.9
- Overview of the Drive p.9



G-Technology™

Introduction

Thank you for purchasing the G-DRIVE from G-Technology. G-DRIVE hard drives are the ideal storage solutions for content creation professionals.

G-DRIVE high-speed interface external storage systems offer the ultimate in flexibility by providing connectivity for USB 3.0, FireWire® 800 and 400. With a massive storage capacity, G-DRIVE is the perfect high-performance solution for storage intensive applications including audio/video editing, digital photography, music libraries and high-speed data back up.

You will love how G-DRIVE looks and sounds. It features the latest HGST 7200 RPM drive with up to 64MB of cache, encased in a rugged, stylish and recyclable enclosure. The drive is whisper quiet with an integrated fan-less cooling system that ensures reliable operation and long life.

G-DRIVE is ideal for automatically backing up your Mac® using Time Machine®. You can also use the drive on a Windows computer or work cross platform.



What's in the Box

The following items are included in the box:

- G-DRIVE hard drive
- (1) USB 3.0 cable, (backwards compatible to USB 2.0)
- (2) FireWire cables (800; 800 to 400)
- AC Power adapter

If any items are missing, please contact G-Technology at g-technology.com/support.



System Requirements

G-DRIVE supports the following Operating Systems. The drive is set up at the factory for use with Mac OS® X systems, and formatted as 'HFS+ with Journaling'.

- Mac OS 10.5 or higher
- Windows XP, Vista or Windows 7



NOTE: G-DRIVE models larger than 2TB are not supported by Windows XP and older 32-bit operating systems. These OS's are limited to a maximum volume size of 2.2TB.

Overview of the Drive

This diagram shows the helpful features of your G-DRIVE. There is a Power & Activity LED on the front of the unit and a Heat Sink beneath it. The activity LED will glow when the unit is switched on. It will flash brighter as data is transferred to or from the hard drive.

On the rear of the unit is a Kensington™ security slot, a USB 3.0 port, 2 FireWire 800 ports, a DC Power In and an On/Off Switch.





Using Your Drive on Mac

- Easy Installation for Mac p.11
- Optimize Performance p.11
- Use with Time Machine p.12
- Disconnect the Drive p.14



G-Technology™

Easy Installation for Mac

G-DRIVE attaches to your computer via the USB 3.0 (backwards compatible with USB 2.0), or one of two FireWire 800 ports. FireWire 400 connectivity is handled by a 9 to 6 pin cable (included). Choose the connection appropriate for your system and connect G-DRIVE with the matching supplied cable.

Connect the power cord to the unit and plug the other end into a surge protector or wall outlet. Turn on the power switch. The drive will automatically mount on the desktop if you are running Mac OS X.

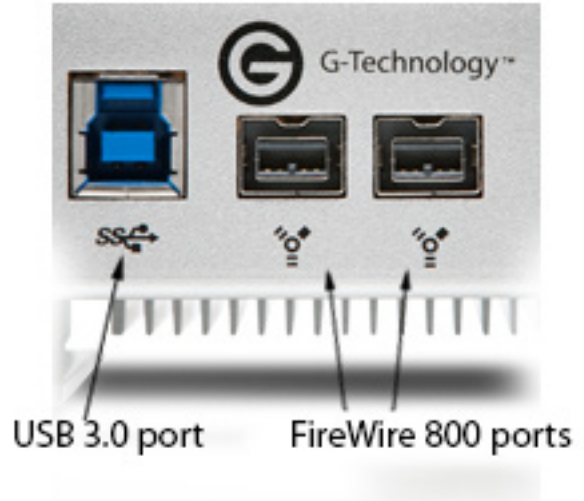

Optimize Performance

G-DRIVE can be connected to any Mac machine equipped with a USB 3.0, FireWire 800 or FireWire 400 port. For Windows, use the USB port.

For best performance, we recommend connecting your G-DRIVE via USB 3.0.

Use with Time Machine

G-DRIVE works perfectly and easily with Time Machine®. Time Machine is an application that ships with your Mac and provides automatic backup for your files. The following steps will quickly set up G-DRIVE with Time Machine.

1. When you attach G-DRIVE for the first time, the Time Machine dialog box should automatically appear. Click the Use as Backup Disk button.

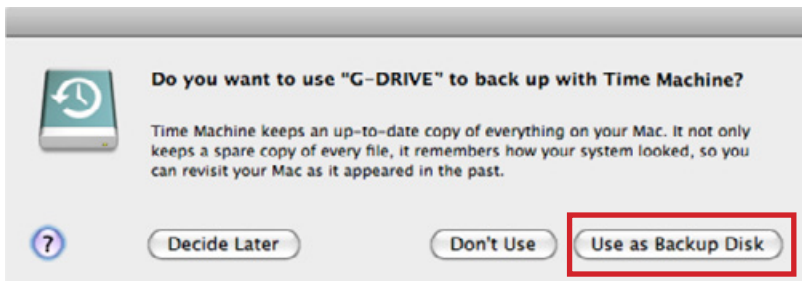

2. If the Time Machine dialog box did not launch, go to the Apple Menu > System Preferences. Click on the Time Machine icon. The Time Machine Preference panel will open. Click the Select Backup Disk button.

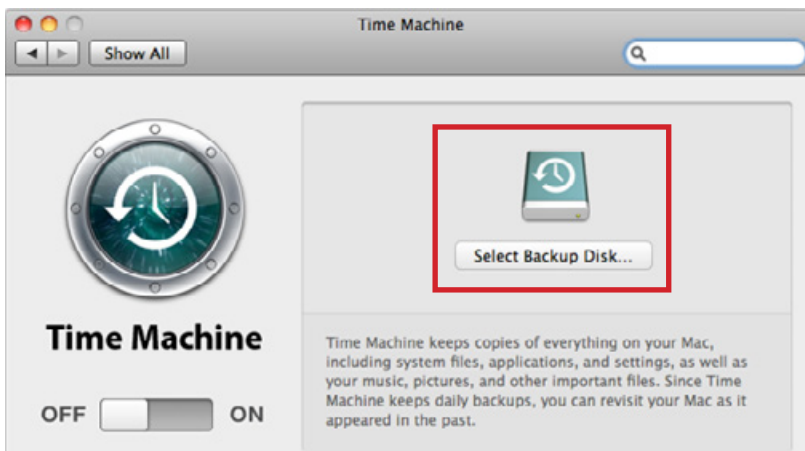

3. In the dialog box that appears, select the G-DRIVE. Click the Use for Backup button.

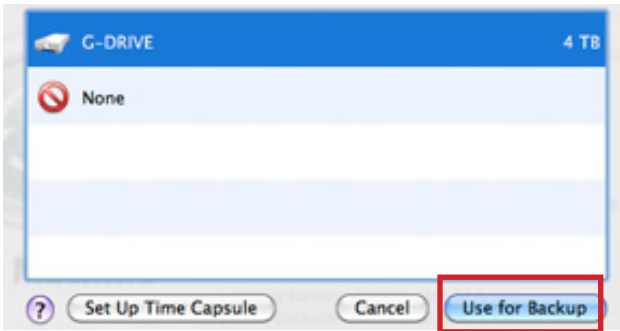

4. Make sure the Time Machine switch is set to ON. You can set its options by clicking the Options button. Do this to choose volumes, folders or files you do NOT want to backup.

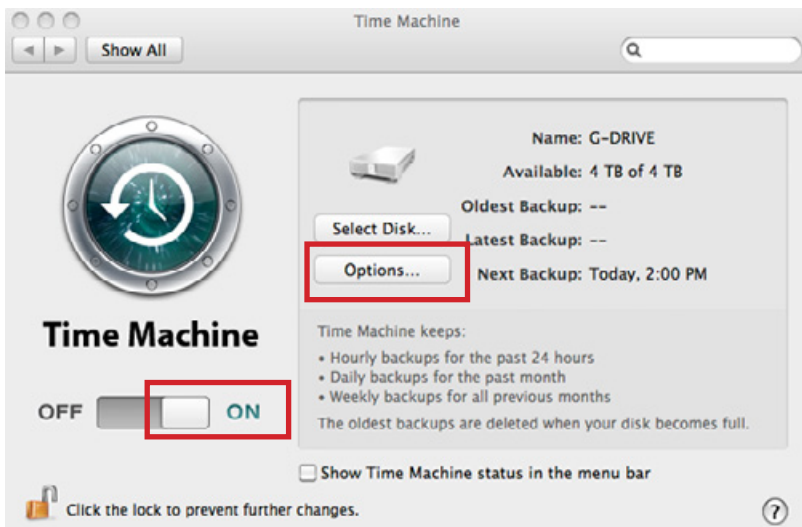

G-DRIVE will now back up your important files automatically with Time Machine. It's that easy!

Disconnect the Drive

A great feature of G-DRIVE is its ability to be connected and disconnected while your computer is running. To prevent failures and/or data loss, it is important to follow the steps below when disconnecting or 'unmounting' the drive from your computer.

1. Before powering down and disconnecting the G-DRIVE, unmount the drive by simply dragging the G-DRIVE icon to the trash located in the dock.

Keyboard shortcut: Select the drive icon and hit Command+E.

2. It is safe to remove the drive from your system when the drive icon is no longer present on your desktop.

Helpful links

- To use G-DRIVE on Windows, go to [Windows Use](#).
- To use G-DRIVE on Mac and Windows together, go to [Cross Platform Use](#).



Maintenance for Your Drive

- Initialize Drive for Mac p.16
- Restore the Drive Icon p.19
- Reformat with Partitions p.21



Initialize Drive for Mac

G-DRIVE was factory-formatted for use or 'initialized' for Mac OS X. You can reinitialize if you would like to quickly erase the contents of the drive. Here are the steps.

1. First, open the Disk Utility program. This application is located on your hard drive under Applications/Utilities/Disk Utility. The window below will appear. Your G-DRIVE will be displayed in the left-hand column.
2. Select the G-DRIVE by clicking its drive icon in the left-side column. Information about the drive will be displayed at the bottom of the window.
3. Select the Erase tab to view the formatting options. By default, the Format pop-up menu is set to the Mac OS Extended (Journaled) option.

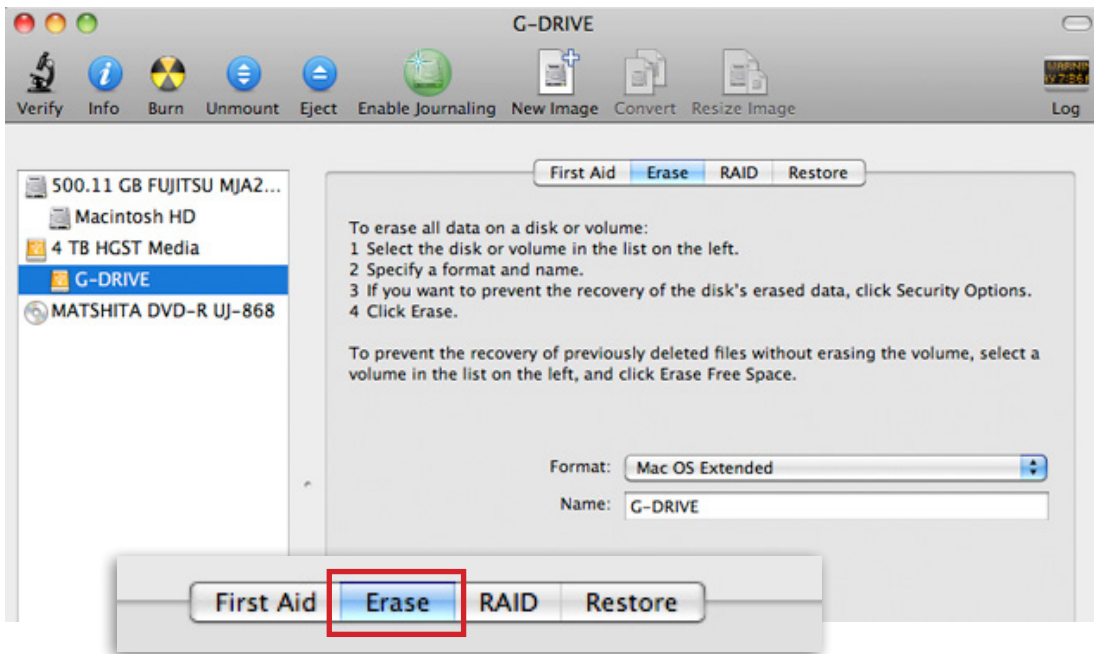

4. Choose the Format option that you prefer.

- Mac OS Extended (Journaled): Use this format if you intend to use the drive for Time Machine or to create a separate bootable installation of OS X.
- Mac OS Extended: Use this format for best performance and media storage. To select, click the Format pop-up and its option to Mac OS Extended.

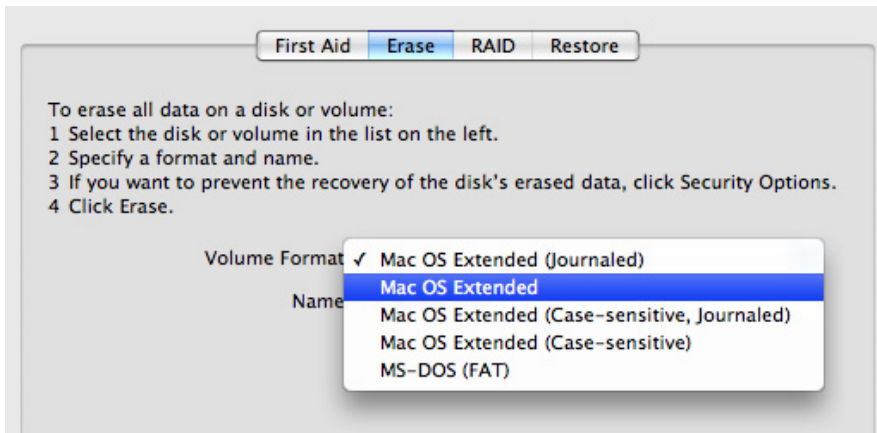

5. Click the Erase button in the lower right corner of the window. A dialog box will appear asking if you want to erase the G-DRIVE partition.

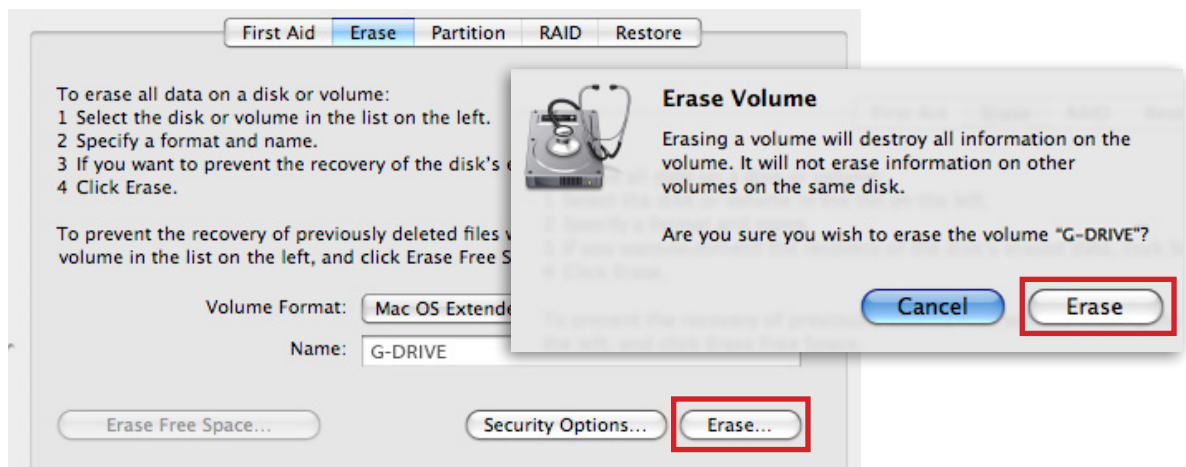

WARNING: THIS NEXT STEP WILL ERASE ALL DATA ON YOUR DRIVE.

6. Click on the Erase button to continue. A progress bar in the lower right corner of the window will show the progress of the disk's reformatting.

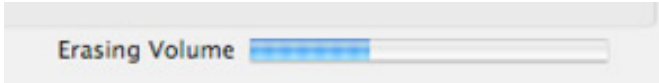

7. After the drive is reinitialized, you should automatically see the Time Machine dialog box.

- Click the Use as Backup Disk button if you want to use the drive with Time Machine. For more info using the drive with Time Machine, [go here](#).
- Click the Don't Use or Decide Later button if you do not want to use Time Machine at this point.



8. Quit the Disk Utility program. After reinitializing the drive, the custom icon for G-DRIVE has been erased. You can optionally restore this icon with the steps on the [next page](#).

Restore the Drive Icon

If the G-DRIVE drive icon was erased during the reinitializing process (see the [previous section](#)), you can restore the icon with the following easy steps.

NOTE: This process is not required for the operation of G-DRIVE. However, it will make your drive's appearance on the computer desktop look nicer and more accurate.

1. To get the G-Technology icon package, go to www.g-technology.com/support and navigate to your product. There will be a link to download the icons.
2. Once downloaded, it should automatically open the G-Technology Icons folder as shown below. If not, double-click the Zip file to open. Then double-click the DMG file to open the G-Technology Icons package.
3. Click to select the drive icon for G-DRIVE in the package window. Press Command+C to copy the icon. (*below*)



4. Select the G-DRIVE icon on your desktop and press Command+I. This opens its Get Info window. *(below left)*
5. Select the default icon in the Get Info window. *(below left)*
6. Press Command+V to paste the custom G-DRIVE icon into the Get Info window. *(below right)*

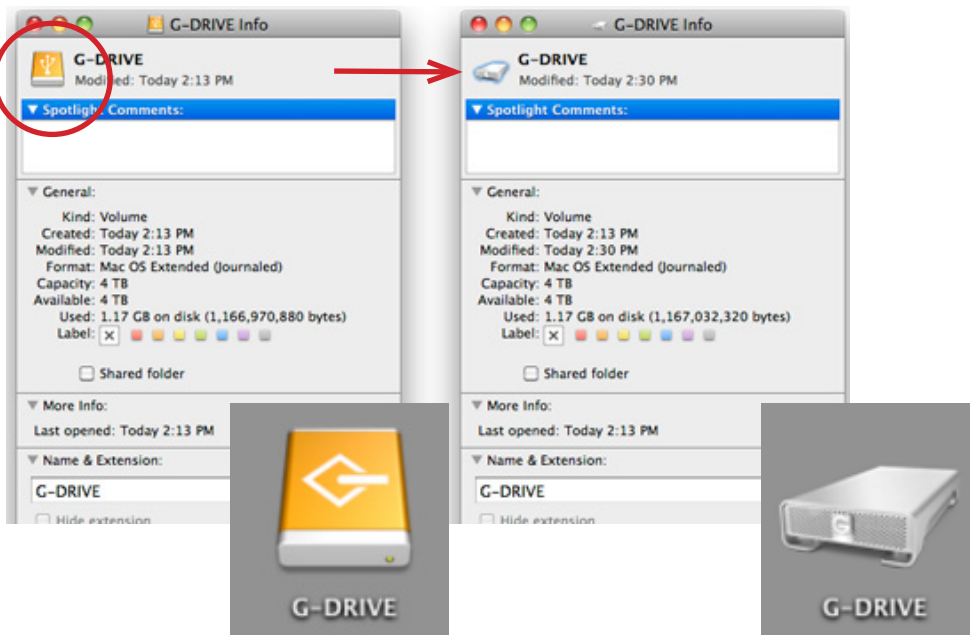

The icon for your G-DRIVE has been restored and you can close the Get Info window. Your drive is now fully ready for use!

Reformat with Partitions

'Partitioning' a hard drive is the process of dividing a hard drive into separate, discrete sections called 'volumes'. Each volume works like a separate disk. You can create up to 16 different partitions on a hard drive in OS X and each partition can be a different size and format.

With hard drives getting bigger, it is useful to partition your hard drive so sections of its space can be used for different purposes. For instance, segment user data from backup data, set up a multi-boot environment with different Operating Systems or create a dedicated capture scratch disk for programs like Final Cut Pro.

The following steps will guide you through this simple process of partitioning your drive. *In this example, we will partition a 4TB G-DRIVE connected via USB 3.0. The steps will be identical for your drive, only the name may be different.*

1. First, open the Disk Utility program. This application is located on your hard drive under Applications/Utilities/Disk Utility. The window below will appear. Your G-Technology drive will be displayed in the left-hand column.

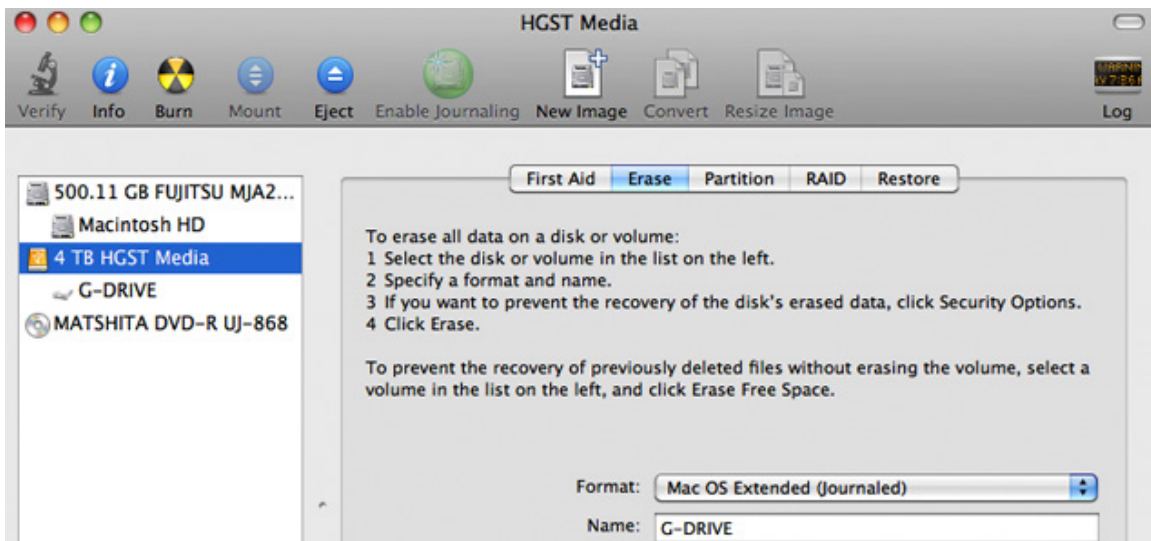

2. Select the FireWire or USB icon – not the G-Technology drive icon – by clicking it in the left-side column.
3. Click on the Partition button in the main window.

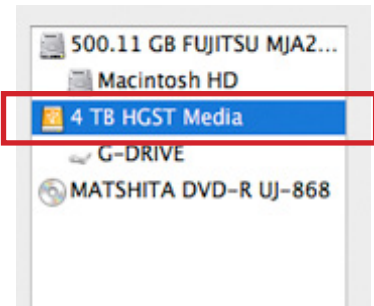

4. Select the number of partitions you would like from the Volume Scheme menu. Below, we have selected '2 Partitions' to create two partitions.

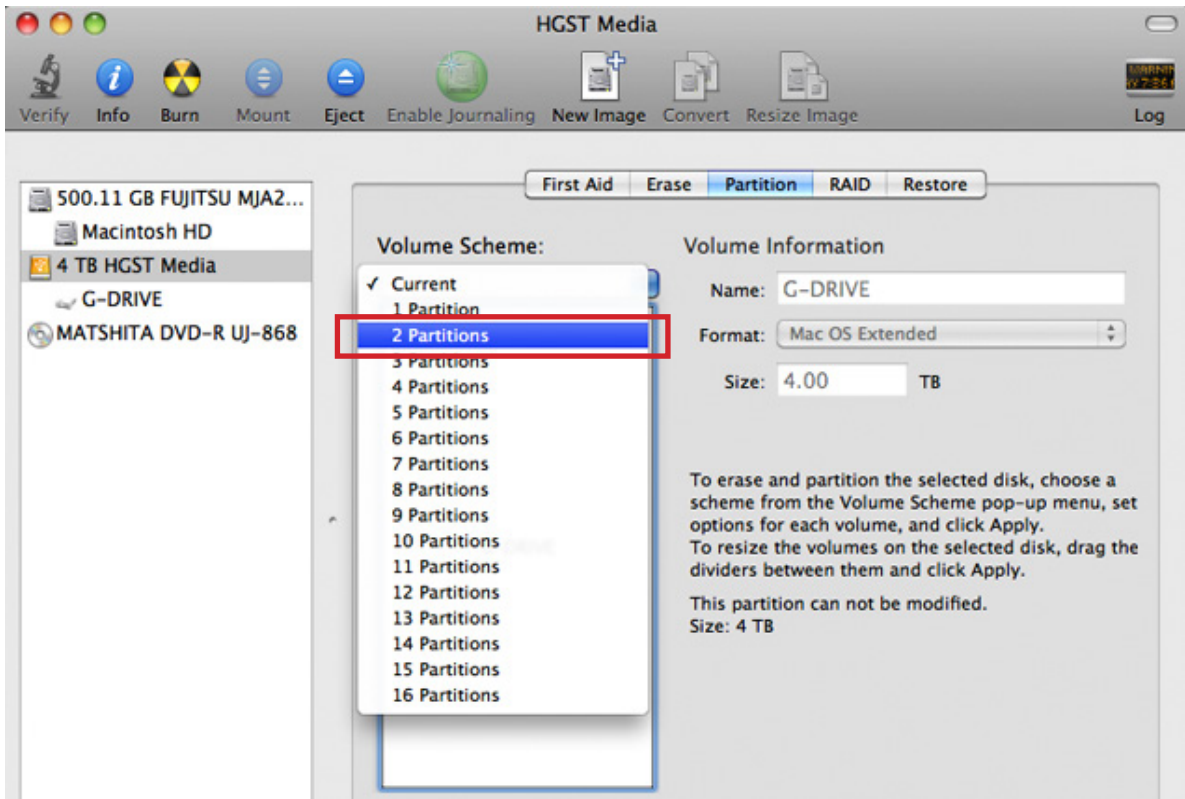

- Click on the first partition in the Volume Scheme area. Your partition will be highlighted by a blue bounding box.
 - In the Name field, type a name for the partition.
 - From the Format menu, choose your desired disk format. If you will use your drive primarily on Mac OSX, it is recommended to use Mac OS Extended or Mac OS Extended (Journaled). For info about formats, [go here](#).
 - In the Size field, type in a size for the partition. Alternately, you can drag the bar in between each partition to quickly change the size.
- Repeat this process for each partition you have created.
- Click the Apply button in the lower right corner of the window. A dialog box will appear asking if you want to erase the G-Technology drive partition.

WARNING: THIS NEXT STEP WILL ERASE ALL DATA ON YOUR DRIVE.

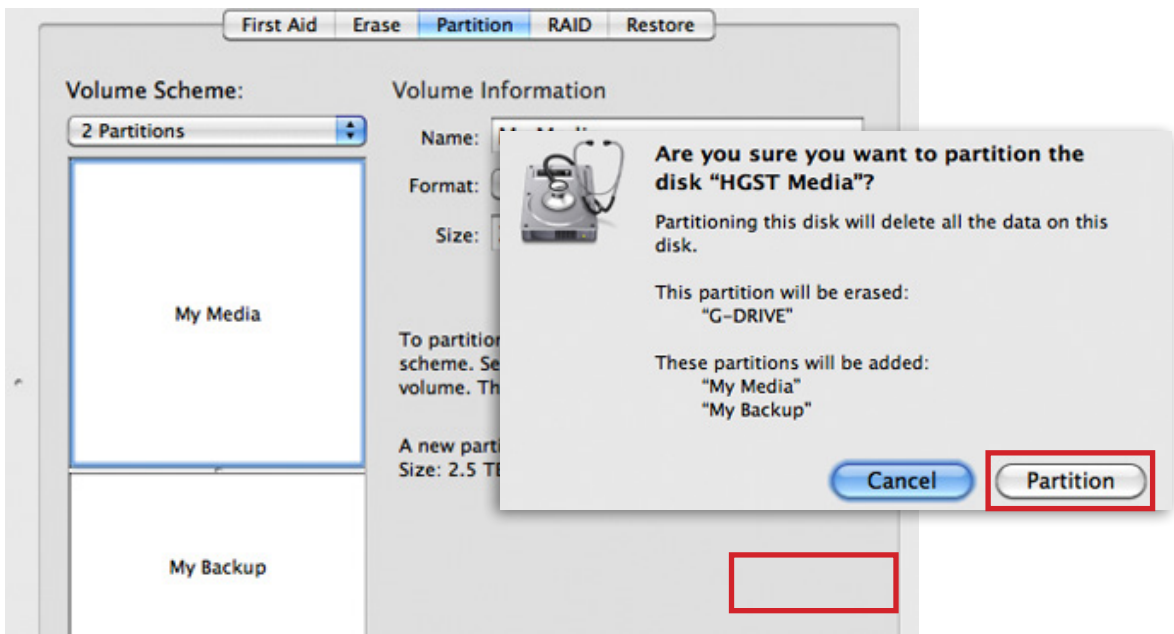

8. Click on the Partition button to continue. A progress bar in the lower right corner of the window will show you the progress of the disk's reformatting.

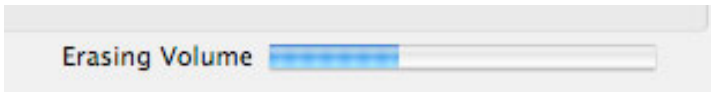

9. When partitioning is complete, the multiple partitions will be displayed in the left-hand panel of Disk Utility.
10. Quit the Disk Utility program. After reinitializing the drive, the custom icon for the G-Technology drive has been erased. You can optionally restore this icon to each partition with the steps on [this page](#).

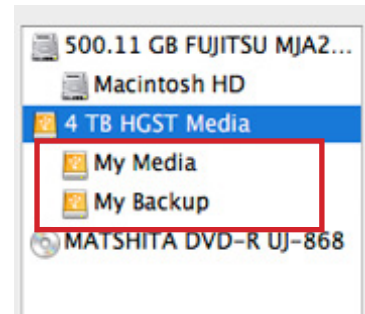

11. The multiple partitions of the G-Technology drive will be displayed on the desktop. Your drive is now setup with two or more partitions and ready for use.

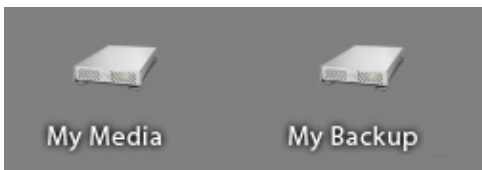



Using Your Drive on Windows

- Windows Use p.26
- Cross Platform Use p.27



G-Technology™

Windows Use

G-DRIVE is set up at the factory for use with Mac OS X systems. A simple initialization will prepare your drive for use with Windows XP, Vista and Windows 7 systems.

For helpful information on configuring and using your drive with Windows, please visit www.g-technology.com/windows

Cross Platform Use

You can set up G-DRIVE for use on both Windows and Mac system by formatting the drive as 'FAT32'. To do this, use the Disk Utility application and format the drive to MS-DOS (FAT), also known as FAT32.

1. First, open the Disk Utility program. This application is located on your hard drive under Applications/Utilities/Disk Utility. The window below will appear. Your G-DRIVE will be displayed in the left-hand column.
2. Select the G-DRIVE by clicking on its drive icon in the left-side column. Information about the drive will be displayed at the bottom of the window.
3. Select the Erase tab to view the formatting options. By default, the Format pop-up menu is set to the Mac OS Extended (Journaled) option.

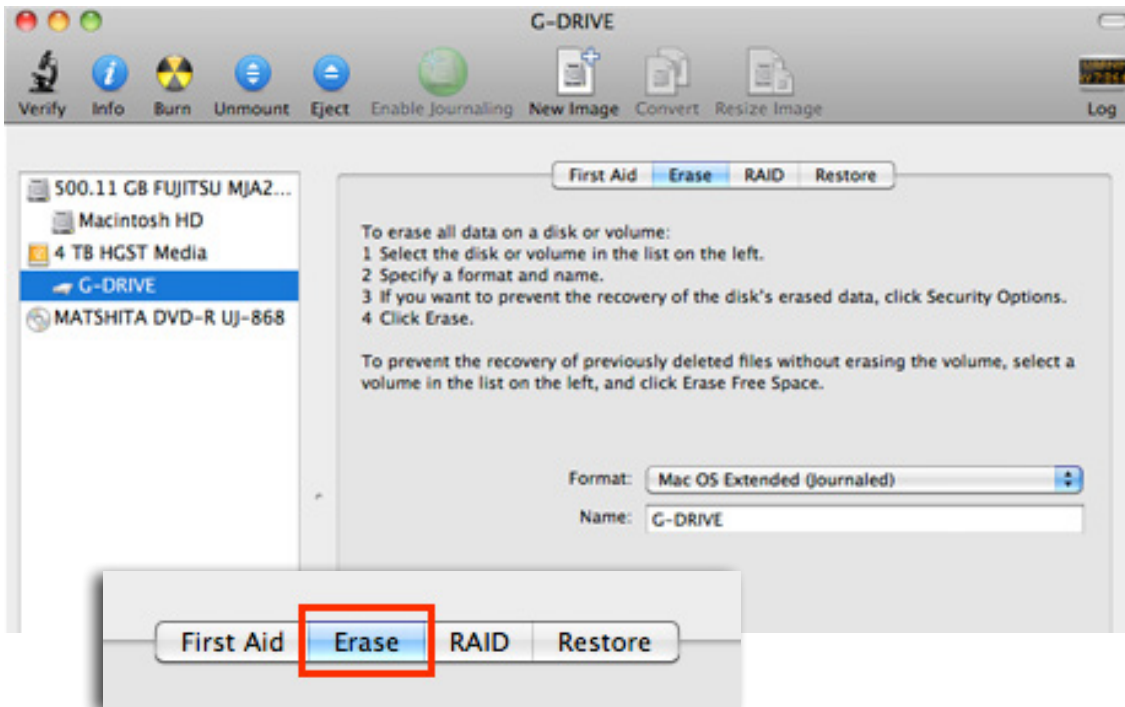

4. Select MS-DOS File System from the Format pop-up menu. This will format to FAT32.
NOTE: You may need to rename the drive because FAT32 does not support more than 11 letters in the drive name.

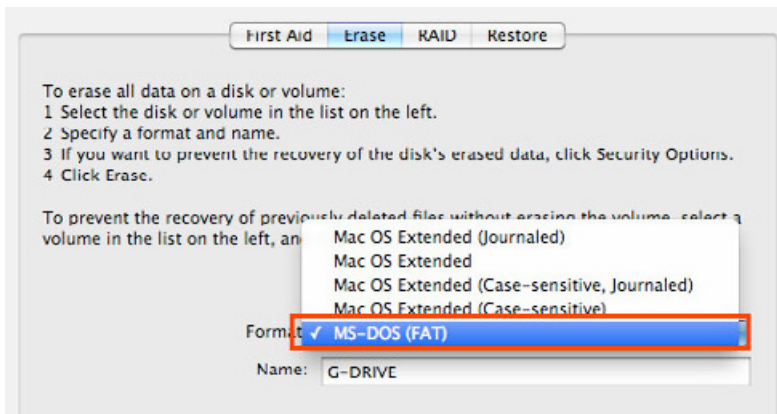

5. Click the Erase button in the lower right corner of the window. A dialog box will appear asking if you want to erase the G-DRIVE partition.

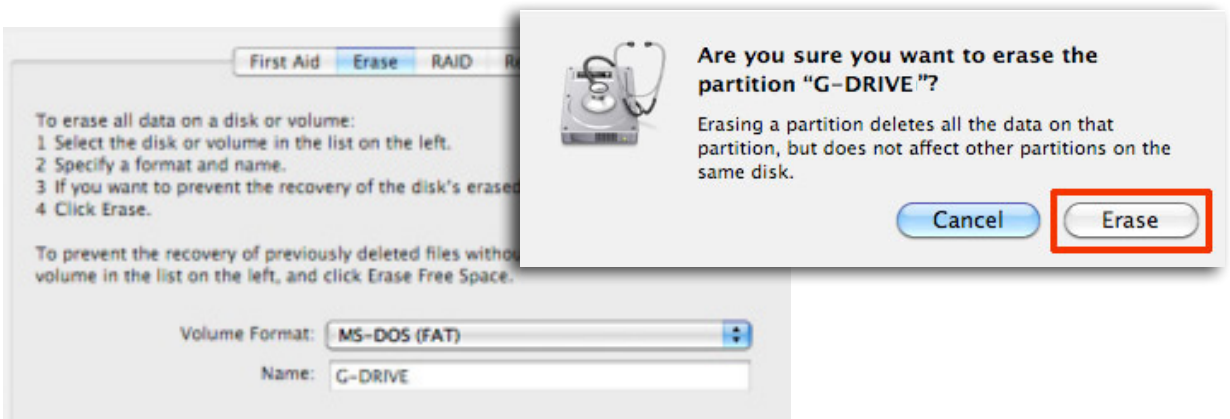

WARNING: THIS NEXT STEP WILL ERASE ALL DATA ON YOUR DRIVE.

5. Click the Erase button. A progress bar in the lower right corner of the window will show the progress of the disk's reformatting. Your drive will be formatted to its full capacity as FAT32.

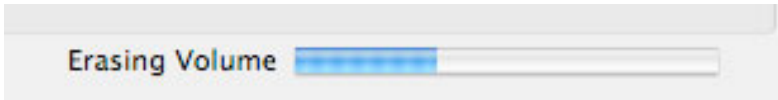

6. Quit the Disk Utility program. You are finished!
7. After reinitializing, the custom icon for the G-DRIVE will be erased. No icons are available for FAT32.

With this format, you will be able to read/write on Windows XP, Vista, and Windows 7 and on Mac OS X machines.

Limitations with FAT32

There are some limitations when using FAT32.

The 'MS-DOS File System' cannot write files over 4 GB. If you are working with files over 4 GB, you may want to choose a software option like MacDrive, www.macdrive.com. MacDrive is Windows software that enables you to mount Mac formatted drives on your Windows computer.

NOTE: You could format your drive on a Windows machine FAT32. However, Windows currently limits FAT32 partitions to only 32GB in size.



Support & Warranty

- Technical Support p.31
- Limited Warranty p.32
- Copyright p.33



G-Technology™

Technical Support

Thank you for purchasing G-DRIVE. If you have any comments or questions about this manual or the product, please let us know!

G-Technology appreciates and values its customers, striving to give you the finest service and support. If you encounter any difficulties while installing or using G-DRIVE, please contact G-Technology Technical Support at g-technology.com/support.

Helpful information for support

When contacting Technical Support, it's best to be in front of your computer and have the following information available:

- Your G-DRIVE serial number (on bottom of unit)
- Operating System and version
- Computer brand and model
- List of other devices attached to your computer

Limited Warranty

HGST, a Western Digital Company (“HGST”)
Including G-Technology for External Hard Disk Drives

What does this limited warranty cover?

This Limited Warranty applies to new HGST products purchased from an authorized HGST dealer by the original purchaser for normal use and not for resale. HGST warrants that a covered product is free from defects in materials and workmanship, with the exceptions stated below.

How long does limited warranty coverage last?

This limited warranty lasts for 1 year, 2 years, 3 years or 5 years, or a fixed period from date of purchase, depending on when and where it was originally purchased. To determine the warranty specifically for your product, visit www.g-technology.com. A valid proof of purchase may be required to prove eligibility. If you do not have a valid proof of purchase, the limited warranty period will be measured from the date of sale from HGST to the authorized distributor.

What does this limited warranty not cover?

The limited warranty does not cover damage resulting from commercial use, misuse, accident, modification or alteration to hardware or software, tampering, unsuitable physical or operating environment beyond product specifications, improper maintenance, or failure caused by a product for which HGST is not responsible.

There is no warranty of uninterrupted or error-free operation. There is no warranty for loss of data—you must regularly back up the data stored on your product to a separate storage product. There is no warranty for product with removed or altered identification labels.

HGST DOES NOT PROVIDE ANY OTHER WARRANTIES OF ANY KIND, INCLUDING, BUT NOT LIMITED TO, THE IMPLIED WARRANTIES OR CONDITIONS OF MERCHANTABILITY AND FITNESS FOR A PARTICULAR PURPOSE. SOME JURISDICTIONS DO NOT ALLOW THE LIMITATION OF IMPLIED WARRANTIES, SO THIS LIMITATION MAY NOT APPLY TO YOU. HGST is not responsible for returning to you product which is not covered by this limited warranty.

What must you do?

If you are having trouble with a product, before seeking limited warranty service, first follow the troubleshooting procedures that HGST or your reseller provides.

To obtain limited warranty service, you must first obtain a Return Materials Authorization (RMA) and ship-to address by contacting G-Technology at <http://www.g-technology.com/support>. Please follow the instructions found on the website. You must return the covered hard disk drive using approved packaging to our logistics center. You must pay any associated transportation charges, duties and insurance in shipping the drive to our logistics center. You should remove all personal information from the product prior to its return.

What will HGST do?

HGST will replace the drive with a functionally equivalent replacement product, transportation pre-paid. HGST may replace your product with a product that was previously used, repaired and tested to meet HGST specifications. You receive title to the replaced product at delivery to carrier at HGST shipping point. You are responsible for importation of the replaced product, if applicable. HGST will not return the original drive to consumers; therefore, the consumer is responsible for moving data to another media before returning. Data Recovery is not covered under this warranty and is not part of the warranty returns process. HGST warrants that the replaced products are covered for the remainder of the original product warranty or 90 days, whichever is greater.

How is our liability limited?

HGST AND ITS AFFILIATES, SUPPLIERS, DISTRIBUTORS, AND RESELLERS ARE NOT LIABLE FOR ANY OF THE FOLLOWING: 1) THIRD-PARTY CLAIMS AGAINST YOU FOR DAMAGES (OTHER THAN BODILY INJURY INCLUDING DEATH AND TANGIBLE PERSONAL PROPERTY; 2) LOSS OF, OR DAMAGE TO, YOUR DATA; OR 3) SPECIAL, INCIDENTAL, OR INDIRECT DAMAGES OR FOR ANY ECONOMIC CONSEQUENTIAL DAMAGES (INCLUDING LOST PROFITS OR SAVINGS), EVEN IF INFORMED OF THE POSSIBILITY. SOME JURISDICTIONS DO NOT ALLOW LIMITATION OF LIABILITY, INCIDENTAL DAMAGES, OR CONSEQUENTIAL DAMAGES, SO THE ABOVE LIMITATIONS MAY NOT APPLY TO YOU.

How do local laws apply?

THIS LIMITED WARRANTY GIVES YOU SPECIFIC LEGAL RIGHTS, AND YOU MAY ALSO HAVE OTHER RIGHTS WHICH VARY FROM JURISDICTION TO JURISDICTION.

CAPACITY DEFINITION AND DISCLAIMER

For G-Technology products 1TB or greater: “One gigabyte (GB) is equal to one billion bytes and one terabyte (TB) equals 1,000 GB (one trillion bytes). Accessible capacity will vary from the stated capacity due to formatting and partitioning of the hard drive, the computer’s operating system, and other factors”

For G-Technology products less than 1TB: “One gigabyte (GB) is equal to one billion bytes when referring to hard drive capacity. Accessible capacity will vary depending on the operating environment and formatting.”

Copyright

One gigabyte (GB) is equal to one billion bytes when referring to hard drive capacity. Accessible capacity will vary depending on the operating environment and formatting.

Design by G-Technology in California. G-DRIVE and G-Technology are trademarks of HGST, a Western Digital company. Apple, Mac, MacBook Pro, FireWire, Time Machine and the Mac logo are trademarks of Apple, Inc. Microsoft, Windows, Windows Vista and Windows XP are trademarks or registered trademarks of Microsoft Corporation in the US and/or other countries. Other trademarks are the property of their respective owners.

©2012 G-Technology. All rights reserved. R0 10/12