

User Manual



EUROLIVE F1320D

Active 300-Watt 2-Way Monitor Speaker System with
12" Woofer, 1" Compression Driver and Feedback Filter

Table of Contents

Thank you	2
Important Safety Instructions	3
Legal Disclaimer	3
Limited Warranty	3
1. Before you Get Started.....	5
1.1 Shipment.....	5
1.2 Initial operation	5
1.3 Online registration	5
2. Control Elements and Connections	6
2.1 Top panel	6
2.2 Side panel.....	6
3. Operation	7
3.1 Connecting signal sources	7
3.2 Connecting multiple F1320D speakers.....	7
3.3 Using F1320D as keyboard amplifier	7
3.4 Notch filter	7
4. Audio Connectors	8
5. Specifications.....	8

Thank you

Thank you very much for expressing your confidence in BEHRINGER products by purchasing the EUROLIVE F1320D floor monitor system. With its comprehensive features and first-grade speakers, the active EUROLIVE F1320D floor monitor system provides the perfect solution for live and playback applications on small- and middle-sized stages. The input section allows you to connect either to a Line source or microphone. There is an adjustable feedback filter and an integrated limiter for ultimate system control and speaker protection plus a dedicated 3-band EQ for perfect sound shaping.

EN Important Safety Instructions



Terminals marked with this symbol carry electrical current of sufficient magnitude to constitute risk of electric shock.

Use only high-quality professional speaker cables with ¼" TS or twist-locking plugs pre-installed. All other installation or modification should be performed only by qualified personnel.



This symbol, wherever it appears, alerts you to the presence of uninsulated dangerous voltage inside the enclosure - voltage that may be sufficient to constitute a risk of shock.



This symbol, wherever it appears, alerts you to important operating and maintenance instructions in the accompanying literature. Please read the manual.



Caution

To reduce the risk of electric shock, do not remove the top cover (or the rear section). No user serviceable parts inside. Refer servicing to qualified personnel.



Caution

To reduce the risk of fire or electric shock, do not expose this appliance to rain and moisture. The apparatus shall not be exposed to dripping or splashing liquids and no objects filled with liquids, such as vases, shall be placed on the apparatus.



Caution

These service instructions are for use by qualified service personnel only. To reduce the risk of electric shock do not perform any servicing other than that contained in the operation instructions. Repairs have to be performed by qualified service personnel.

1. Read these instructions.
2. Keep these instructions.
3. Heed all warnings.
4. Follow all instructions.
5. Do not use this apparatus near water.
6. Clean only with dry cloth.
7. Do not block any ventilation openings. Install in accordance with the manufacturer's instructions.
8. Do not install near any heat sources such as radiators, heat registers, stoves, or other apparatus (including amplifiers) that produce heat.

9. Do not defeat the safety purpose of the polarized or grounding-type plug. A polarized plug has two blades with one wider than the other. A grounding-type plug has two blades and a third grounding prong. The wide blade or the third prong are provided for your safety. If the provided plug does not fit into your outlet, consult an electrician for replacement of the obsolete outlet.

10. Protect the power cord from being walked on or pinched particularly at plugs, convenience receptacles, and the point where they exit from the apparatus.

11. Use only attachments/accessories specified by the manufacturer.



12. Use only with the cart, stand, tripod, bracket, or table specified by the manufacturer, or sold with the apparatus. When a cart is used, use caution when moving the cart/apparatus combination to avoid

injury from tip-over.

13. Unplug this apparatus during lightning storms or when unused for long periods of time.

14. Refer all servicing to qualified service personnel. Servicing is required when the apparatus has been damaged in any way, such as power supply cord or plug is damaged, liquid has been spilled or objects have fallen into the apparatus, the apparatus has been exposed to rain or moisture, does not operate normally, or has been dropped.

15. The apparatus shall be connected to a MAINS socket outlet with a protective earthing connection.

16. Where the MAINS plug or an appliance coupler is used as the disconnect device, the disconnect device shall remain readily operable.



LEGAL DISCLAIMER

TECHNICAL SPECIFICATIONS AND APPEARANCES ARE SUBJECT TO CHANGE WITHOUT NOTICE AND ACCURACY IS NOT GUARANTEED. BEHRINGER IS PART OF THE MUSIC GROUP (MUSIC-GROUP.COM). ALL TRADEMARKS ARE THE PROPERTY OF THEIR RESPECTIVE OWNERS. MUSIC GROUP ACCEPTS NO LIABILITY FOR ANY LOSS WHICH MAY BE SUFFERED BY ANY PERSON WHO RELIES EITHER WHOLLY OR IN PART UPON ANY DESCRIPTION, PHOTOGRAPH OR STATEMENT CONTAINED HEREIN. COLORS AND SPECIFICATIONS MAY VARY FROM ACTUAL PRODUCT. MUSIC GROUP PRODUCTS ARE SOLD THROUGH AUTHORIZED FULLFILLERS AND RESELLERS ONLY. FULLFILLERS AND RESELLERS ARE NOT AGENTS OF MUSIC GROUP AND HAVE ABSOLUTELY NO AUTHORITY TO BIND MUSIC GROUP BY ANY EXPRESS OR IMPLIED

UNDERTAKING OR REPRESENTATION. THIS MANUAL IS COPYRIGHTED. NO PART OF THIS MANUAL MAY BE REPRODUCED OR TRANSMITTED IN ANY FORM OR BY ANY MEANS, ELECTRONIC OR MECHANICAL, INCLUDING PHOTOCOPYING AND RECORDING OF ANY KIND, FOR ANY PURPOSE, WITHOUT THE EXPRESS WRITTEN PERMISSION OF MUSIC GROUP IP LTD.

ALL RIGHTS RESERVED.

© 2012 MUSIC Group IP Ltd.

Trident Chambers, Wickhams Cay, P.O. Box 146, Road Town, Tortola, British Virgin Islands

LIMITED WARRANTY

§ 1 Warranty

1 This limited warranty is valid only if you purchased the product from a MUSIC Group Authorized Reseller in the country of purchase. A list of authorized resellers can be found on BEHRINGER's website behringer.com under "Where to Buy", or you can contact the MUSIC Group office closest to you.

2 MUSIC Group* warrants the mechanical and electronic components of this product to be free of defects in material and workmanship if used under normal operating conditions for a period of one (1) year from the original date of purchase (see the Limited Warranty terms in § 4 below), unless a longer minimum warranty period is mandated by applicable local laws. If the product shows any defects within the specified warranty period and that defect is not excluded under § 4, MUSIC Group shall, at its discretion, either replace or repair the product using suitable new or reconditioned product or parts. In case MUSIC Group decides to replace the entire product, this limited warranty shall apply to the replacement product for the remaining initial warranty period, i.e., one (1) year (or otherwise applicable minimum warranty period) from the date of purchase of the original product.

3 Upon validation of the warranty claim, the repaired or replacement product will be returned to the user freight prepaid by MUSIC Group.

4 Warranty claims other than those indicated above are expressly excluded.

PLEASE RETAIN YOUR SALES RECEIPT. IT IS YOUR PROOF OF PURCHASE COVERING YOUR LIMITED WARRANTY. THIS LIMITED WARRANTY IS VOID WITHOUT SUCH PROOF OF PURCHASE.

§ 2 Online registration

Please do remember to register your new BEHRINGER equipment right after your purchase at behringer.com under "Support" and kindly read the terms and conditions of our limited warranty carefully. Registering your purchase and equipment with us helps us process your repair claims quicker and more efficiently. Thank you for your cooperation!

§ 3 Return materials authorization

1 To obtain warranty service, please contact the retailer from whom the equipment was purchased. Should your MUSIC Group Authorized Reseller not be located in your vicinity, you may contact the MUSIC Group Authorized Fulfiller for your country listed under

“Support” at behringer.com. If your country is not listed, please check if your problem can be dealt with by our “Online Support” which may also be found under “Support” at behringer.com. Alternatively, please submit an online warranty claim at behringer.com BEFORE returning the product. All inquiries must be accompanied by a description of the problem and the serial number of the product. After verifying the product’s warranty eligibility with the original sales receipt, MUSIC Group will then issue a Return Materials Authorization (“RMA”) number.

② Subsequently, the product must be returned in its original shipping carton, together with the return authorization number to the address indicated by MUSIC Group.

③ Shipments without freight prepaid will not be accepted.

§ 4 Warranty Exclusions

① This limited warranty does not cover consumable parts including, but not limited to, fuses and batteries. Where applicable, MUSIC Group warrants the valves or meters contained in the product to be free from defects in material and workmanship for a period of ninety (90) days from date of purchase.

② This limited warranty does not cover the product if it has been electronically or mechanically modified in any way. If the product needs to be modified or adapted in order to comply with applicable technical or safety standards on a national or local level, in any country which is not the country for which the product was originally developed and manufactured, this modification/adaptation shall not be considered a defect in materials or workmanship. This limited warranty does not cover any such modification/adaptation, regardless of whether it was carried out properly or not. Under the terms of this limited warranty, MUSIC Group shall not be held responsible for any cost resulting from such a modification/adaptation.

③ This limited warranty covers only the product hardware. It does not cover technical assistance for hardware or software usage and it does not cover any software products whether or not contained in the product. Any such software is provided “AS IS” unless expressly provided for in any enclosed software limited warranty.

④ This limited warranty is invalid if the factory-applied serial number has been altered or removed from the product.

⑤ Free inspections and maintenance/repair work are expressly excluded from this limited warranty, in particular, if caused by improper handling of the product by the user. This also applies to defects caused by normal wear and tear, in particular, of faders, crossfaders, potentiometers, keys/buttons, guitar strings, illuminants and similar parts.

⑥ Damage/defects caused by the following conditions are not covered by this limited warranty:

- improper handling, neglect or failure to operate the unit in compliance with the instructions given in BEHRINGER user or service manuals;

- connection or operation of the unit in any way that does not comply with the technical or safety regulations applicable in the country where the product is used;
- damage/defects caused by acts of God/Nature (accident, fire, flood, etc) or any other condition that is beyond the control of MUSIC Group.

⑦ Any repair or opening of the unit carried out by unauthorized personnel (user included) will void the limited warranty.

⑧ If an inspection of the product by MUSIC Group shows that the defect in question is not covered by the limited warranty, the inspection costs are payable by the customer.

⑨ Products which do not meet the terms of this limited warranty will be repaired exclusively at the buyer’s expense. MUSIC Group or its authorized service center will inform the buyer of any such circumstance. If the buyer fails to submit a written repair order within 6 weeks after notification, MUSIC Group will return the unit C.O.D. with a separate invoice for freight and packing. Such costs will also be invoiced separately when the buyer has sent in a written repair order.

⑩ MUSIC Group Authorized Resellers do not sell new products directly in online auctions. Purchases made through an online auction are on a “buyer beware” basis. Online auction confirmations or sales receipts are not accepted for warranty verification and MUSIC Group will not repair or replace any product purchased through an online auction.

§ 5 Warranty transferability

This limited warranty is extended exclusively to the original buyer (customer of authorized reseller) and is not transferable to anyone who may subsequently purchase this product. No other person (reseller, etc.) shall be entitled to give any warranty promise on behalf of MUSIC Group.

§ 6 Claim for damage

Subject only to the operation of mandatory applicable local laws, MUSIC Group shall have no liability to the buyer under this warranty for any consequential or indirect loss or damage of any kind. In no event shall the liability of MUSIC Group under this limited warranty exceed the invoiced value of the product.

§ 7 Limitation of liability

This limited warranty is the complete and exclusive warranty between you and MUSIC Group. It supersedes all other written or oral communications related to this product. MUSIC Group provides no other warranties for this product.

§ 8 Other warranty rights and national law

① This limited warranty does not exclude or limit the buyer’s statutory rights as a consumer in any way.

② The limited warranty regulations mentioned herein are applicable unless they constitute an infringement of applicable mandatory local laws.

③ This warranty does not detract from the seller’s obligations in regard to any lack of conformity of the product and any hidden defect.

§ 9 Amendment

Warranty service conditions are subject to change without notice. For the latest warranty terms and conditions and additional information regarding MUSIC Group’s limited warranty, please see complete details online at behringer.com.

* MUSIC Group Macao Commercial Offshore Limited of Rue de Pequim No. 202-A, Macau Finance Centre 9/J, Macau, including all MUSIC Group companies

1. Before you Get Started

1.1 Shipment

Your product was carefully packed at the factory to ensure safe transport. Nevertheless, if the box is damaged inspect the unit immediately for signs of damage.

- ◆ If the unit is damaged please do NOT return it to us, but notify your dealer and the shipping company immediately; otherwise, claims for damage or replacement may not be granted.
- ◆ Always use the original box to prevent damage during storage or transport.
- ◆ Make sure that children cannot play unsupervised with the unit or its packaging.
- ◆ Please ensure proper disposal of all packing materials.

1.2 Initial operation

Ensure adequate air supply and to avoid overheating do not place the unit near radiators etc.



Caution

- ◆ Before you change the fuse, switch off the device and pull the plug to avoid electric shock or damage to the device.
- ◆ Blown fuses must be replaced by fuses of the correct rating! Please refer to the "Specifications" section for the applicable rating.

The fuse holder on the mains connector has 3 triangular markings. Two of these triangles opposing each other. The device is set to the operating voltage printed next to these markers and can be set to another voltage by turning the fuse holder by 180°.

For connection to the mains use the enclosed power cord with cold connector which complies with the relevant safety regulations.

- ◆ Please make sure that all devices are properly grounded. For your own safety, never remove or disable the ground conductors from the devices or on the power cords. The unit must always be connected to the mains outlet with a protective grounding connection.



Caution

- ◆ This loudspeaker is capable of producing extreme volumes. Please keep in mind that high sound pressures do not only temporarily damage your sense of hearing, but can also cause permanent hearing damage. Be careful to select a suitable volume at all times.



Important notes concerning installation

- ◆ The sound quality may diminish within the range of powerful broadcasting stations and high-frequency sources. Increase the distance between the transmitter and the device and use shielded cables for all connections.

1.3 Online registration

Please register your new BEHRINGER equipment right after your purchase by visiting <http://behringer.com> and read the terms and conditions of our warranty carefully.

Should your BEHRINGER product malfunction, it is our intention to have it repaired as quickly as possible. To arrange for warranty service, please contact the BEHRINGER retailer from whom the equipment was purchased. Should your BEHRINGER dealer not be located in your vicinity, you may directly contact one of our subsidiaries. Corresponding contact information is included in the original equipment packaging (Global Contact Information/European Contact Information). Should your country not be listed, please contact the distributor nearest you. A list of distributors can be found in the support area of our website (<http://behringer.com>).

Registering your purchase and equipment with us helps us process your repair claims more quickly and efficiently.

Thank you for your cooperation!

2. Control Elements and Connections

2.1 Top panel

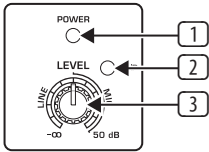

Fig. 2.1: First group control

- 1 The **POWER** LED lights up when the loudspeaker is put into operation.
- 2 The **CLIP** LED lights up when signal distortion occurs. Reduce the volume with the **LEVEL** control until the **CLIP** LED does not light up any more, or occasionally lights up at signal peaks.
- 3 To set the volume of the **LINE** or **MIC** signal, use the **LEVEL** control. The left half of the control range is for attenuating the **LINE** signal. The right half is for raising the level of the **MIC** signal.

Level adjusting: Turn the **LEVEL** control whose signal you want to adjust slowly to the right until the **CLIP LED** (2) lights up only at signal peaks. The LED is not supposed to glow continuously.

- ◆ We would like to draw your attention to the fact that extremely loud sound levels may damage your hearing as well as your headphones/ loudspeakers. Turn the **LEVEL** control fully to the left before you switch on the unit. Be careful to select a suitable volume at all times.

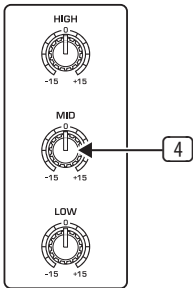

Fig. 2.2: Equalizer

- 4 The F1320D features a 3-band sound control. Each band provides a maximum boost/cut of 15 dB. At center position the equalizer has a flat response.

The upper (**EQ HIGH**) and the lower band (**EQ LOW**) are shelving filters that boost and cut all frequencies above and below the crossover frequency. The crossover frequencies of the upper and lower bands are at 12 kHz and 80 Hz, respectively. The mid band (**EQ MID**) is a peak filter the center frequency of which is at 2.5 kHz.

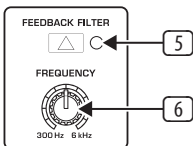

Fig. 2.3: Feedback filter (notch filter)

Feedback may occur at high volume levels or under difficult stage situations. Use the **FEEDBACK FILTER** function (5, 6) to reduce feedback. To learn more about the feedback filter, read section 3.4 "Notch filter."

- 5 This switch turns on the feedback filter.
- 6 This control adjusts the center frequency of the feedback filter.

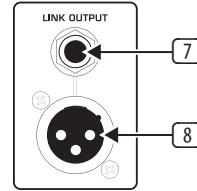

Fig. 2.4: LINK OUTPUT

- 7 + 8 The **LINK OUTPUT** is directly connected to the inputs of the F1320D and carries the input signal with no processing applied. In this way, you can route the signal to the input of another device (for example, a second F1320D).

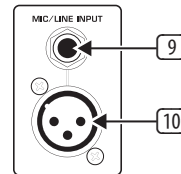

Fig. 2.5: MIC/LINE INPUT

- 9 Use this 1/4" stereo jack to connect a signal source that has 1/4" output.
- 10 Use this XLR connector to connect a signal source that has XLR output.

- ◆ Always use either the XLR or the 1/4" jack input, and use the **LEVEL** control to adapt the input sensitivity. Never use both inputs at the same time!

2.2 Side panel

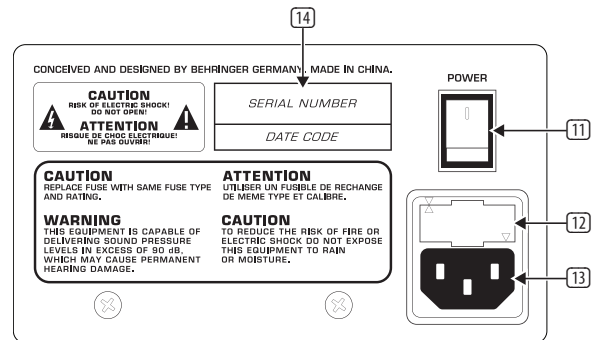

Fig. 2.6: Side panel F1320D

- 11 Press **POWER** to turn on your F1320D.
- ◆ The **POWER** switch does not fully disconnect the unit from the mains. To disconnect the unit from the mains, pull out the main cable plug or appliance coupler. When installing the product, ensure the plug or appliance coupler is readily operable. Unplug the power cord completely when the unit is not used for prolonged periods of time.
- 12 You can replace fuses at the **FUSE SWITCH** of the F1320D. Always replace fuses with the same type. Please follow the instructions given in the chapter "Specifications."
- 13 The mains connection is established using a cable with an **IEC** mains connector. This cable is delivered with the F1320D. To avoid ground-loop hum, loudspeakers and mixing consoles should be connected to the same power circuit.
- 14 Serial number.

3. Operation

Use the Monitor/Aux output of a mixer to route the audio signal to the F1320D. When using the monitor mix with more loudspeakers, route the audio signal of the first F1320D to the next speaker via the LINK output. The volume level of each F1320D is adjusted with the respective LEVEL control.

3.1 Connecting signal sources

With an F1320D and a microphone, you are able to master small PA tasks with minimum effort. The F1320D can also be used with equipment which include LINE outputs, such as keyboards, playback devices (for example, CD players) and mixers with AUX Send outputs.

Connecting a signal source

- Turn the LEVEL control fully to the left.
- Connect the signal source to the MIC/LINE input.
- Turn on the F1320D.
- Turn the LEVEL control slowly to the right until you have reached the desired volume level. The CLIP LED helps you in this case. The LED should only light up at signal peaks, but shouldn't glow continuously.



Caution: risk of feedback!

- ◆ Don't let the microphone's most sensitive side (front) face the loudspeaker. Make sure to keep sufficient distance between the microphone and the loudspeaker when using the F1320D.

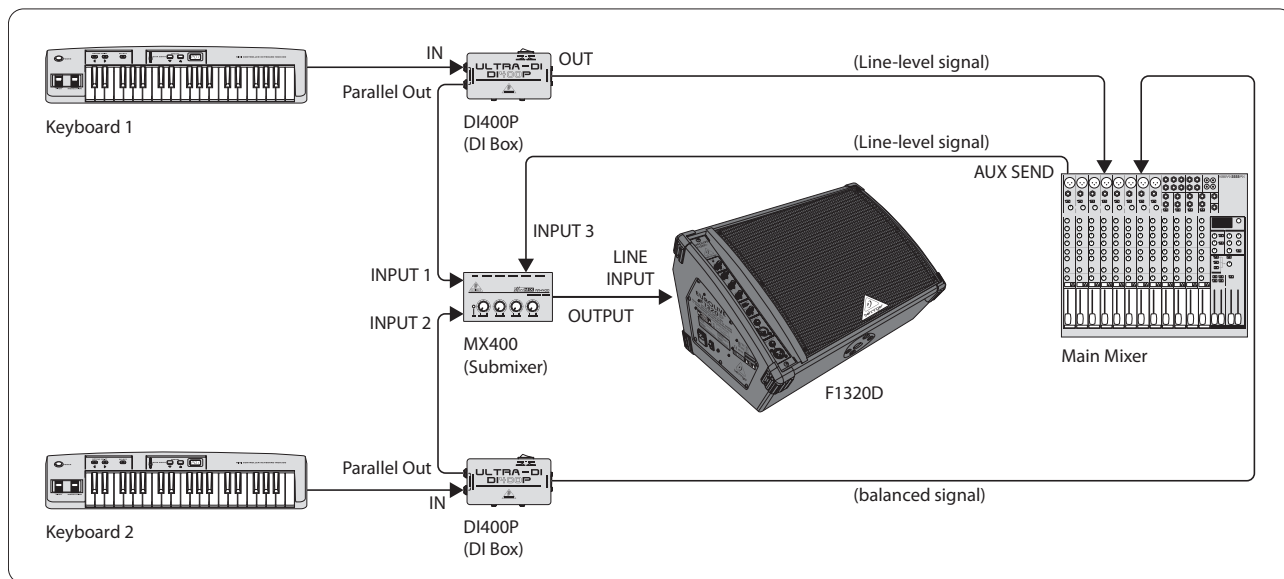

Fig. 3.1: F1320D with two keyboards

3.2 Connecting multiple F1320D speakers

If you want to use the same monitor mix on bigger stages, simply increase the number of stage monitors. For example, connect two F1320D monitors via the LINK output. Either a microphone or line signal can be routed to the first F1320D.

Connecting to an active loudspeaker

- Connect the LINK output of the first loudspeaker with the LINE input of the second loudspeaker.

3.3 Using F1320D as keyboard amplifier

Usually guitar and bass guitar players have amplifiers which allow them to be heard when playing on stage—even when a monitor system is being used. These amps have enough power to be used on smaller stages. However, it's quite a different matter for the keyboardists because they normally won't use instrument amplifiers.

It is possible to connect a keyboard directly to the F1320D. In case you want to hook up two keyboards, use a submixer, such as the MicroMIX MX400, to join both signals and then connect the mixer's output to the LINE input of the F1320D. Route the Aux/Monitor signal coming from the main mixer to the submixer so that you can hear your band members as well (see fig. 3.1).

3.4 Notch filter

A notch filter cancels a narrow frequency band of the signal being used. Typical interferences, such as feedback and rumble, are found close to the signal and are therefore easily filtered out.

To pinpoint the interfering frequency, activate the filter and slowly turn the FREQUENCY control from the left to the right.

- ◆ We recommend using our proven FEEDBACK DESTROYER PRO FBQ2496 feedback suppressor for signals with line level should continuous feedback problems occur. For line- or microphone-level signals, we recommend our SHARK FBQ100 signal processor.

4. Audio Connectors

Both audio inputs of the BEHRINGER F1320D and the LINK OUTPUT connector are fully balanced. To maximize interference compensation, try to establish balanced connections to other equipment, whenever possible.

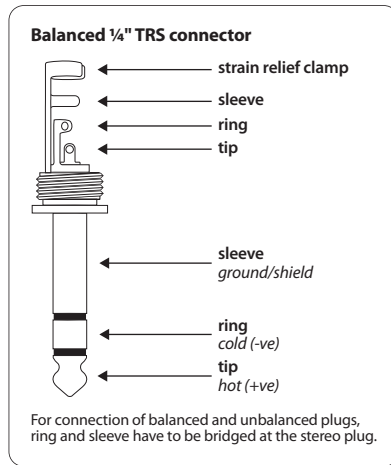

Fig. 4.1: 1/4" TRS connector

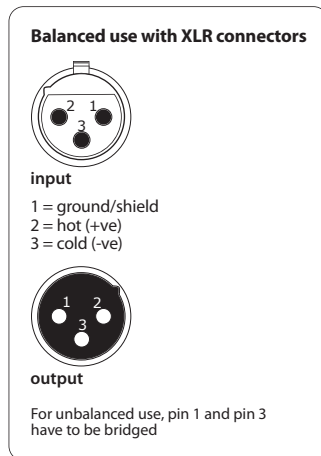

Fig. 4.2: XLR connectors

- ◆ **Make sure that only competent people install your F1320D. They must be sufficiently earthed during and after the installation process. Otherwise, electrostatic discharges may negatively affect the operating characteristics of your equipment.**

5. Specifications

Output Power

Low-frequency range

RMS @ 1% THD 160 W @ 8 Ω

Peak Power 225 W @ 8 Ω

High-frequency range

RMS @ 1% THD 40 W @ 8 Ω

Peak Power 72 W @ 8 Ω

Mic/Line Inputs

XLR connector

Sensitivity -50 dBu to 0 dBu

Impedance 20 kΩ balanced, 30 kΩ unbalanced

1/4" TRS connector

Sensitivity -50 dBu to 0 dBu

Impedance 20 kΩ balanced, 30 kΩ unbalanced

Link Output

XLR connector

Equalizer

High 12 kHz / ±15 dB

Mid 2.5 kHz / ±15 dB

Low 80 Hz / ±15 dB

Feedback Filter

Filter frequency 300 Hz to 6 kHz

Level reduction max. 15 dB

Q factor 20

Loudspeaker System Data

Frequency range 60 Hz to 16 kHz (-10 dB)

Maximum sound pressure level 115 dB / 118 dB @ 1 m

Limiter optical

Power Supply/Voltage (Fuses)

USA/Canada	120 V~, 60 Hz (T 4.0 A H 250 V)
UK/Australia	240 V~, 50 Hz (T 2.0 A H 250 V)
Europe	230 V~, 50 Hz (T 2.0 A H 250 V)
Korea	220 V~, 60 Hz (T 2.0 A H 250 V)
China	220 V~, 50 Hz (T 2.0 A H 250 V)
Japan	100 V~, 50/60 Hz (T 4.0 A H 250 V)
Power consumption	max. 300 Watts
Power supply	switch mode
Mains connection	standard IEC receptacle

Dimensions/Weight

Dimensions (H x W x D)	appr. 14.2 x 22.8 x 16" appr. 360 x 580 x 406 mm
Weight	appr. 33.1 lbs / appr. 15 kg



We Hear You