

***Dual Alarm AM/FM Clock Radio  
with SmartSet<sup>®</sup>  
Automatic Time Setting System  
and Sure Alarm***

*(U.S. Patent No. 6,567,344)*

**OWNER'S MANUAL**



**CKS2862**

Visit our web site at [www.emersonradio.com](http://www.emersonradio.com)



## CAUTION

TO PREVENT FIRE OR SHOCK HAZARD, DO NOT USE THIS PLUG WITH AN EXTENSION CORD, RECEPTACLE OR OTHER OUTLET UNLESS THE BLADES CAN BE FULLY INSERTED TO PREVENT BLADE EXPOSURE. TO PREVENT FIRE OR SHOCK HAZARD, DO NOT EXPOSE THIS APPLIANCE TO RAIN OR MOISTURE.

 <p>The lightning flash with arrow-head symbol, within an equilateral triangle is intended to alert the user to the presence of uninsulated 'dangerous voltage' within the product's enclosure that may be of sufficient magnitude to constitute a risk of electric shock to persons.</p>	<p style="text-align: center;"><b>CAUTION</b></p> <p style="text-align: center;">RISK OF ELECTRIC SHOCK DO NOT OPEN</p> <p><b>WARNING: TO REDUCE THE RISK OF ELECTRIC SHOCK DO NOT REMOVE COVER (OR BACK), NO USER SERVICEABLE PARTS INSIDE REFER SERVICING TO QUALIFIED SERVICE PERSONNEL.</b></p>	 <p>The exclamation point within an equilateral triangle is intended to alert the user to the presence of important operating and maintenance (servicing) instructions in the literature accompanying the appliance.</p>
--	---	---

The Caution Marking maybe located at the bottom enclosure of the apparatus.

## IMPORTANT SAFETY INSTRUCTIONS

- 1.) Read these instructions. Keep these instructions. Follow all instructions. Heed all warnings.
- 2.) Do not use this apparatus near water.
- 3.) Clean only with dry cloth.
- 4.) Do not block any ventilation openings. Install in accordance with the manufacturer's instructions.
- 5.) Do not install near any heat sources such as radiators, heat registers, stoves, or other apparatus (including amplifiers) that produce heat.
- 6.) Do not defeat the safety purpose of the polarized or grounding-type plug. A polarized plug has two blades with one wider than the other. A grounding type plug has two blades and a third grounding prong. The wide blade or the third prong is provided for your safety. If the provided plug does not fit into your outlet, consult an electrician for replacement of the obsolete outlet.
- 7.) Protect the power cord from being walked on or pinched particularly at plugs, convenience receptacles, and the point where they exit from the apparatus.
- 8.) Only use attachments / accessories specified by the manufacturer.
- 9.) Unplug this apparatus during lightning storms or when unused for long periods of time.
- 10.) Refer all servicing to qualified service personnel. Servicing is required when the apparatus has been damaged in any way, such as power-supply cord or plug is damaged, liquid has been spilled or objects have fallen into the apparatus, the apparatus has been exposed to rain or moisture, does not operate normally, or has been dropped.
- 11.) This appliance shall not be exposed to dripping or splashing water and no object filled with liquids such as vases shall be placed on the apparatus.
- 12.) Use only with the cart, stand, tripod, bracket, or table specified by the manufacturer, or sold with the apparatus. When a cart is used, use caution when moving the cart/apparatus combination to avoid injury from tip-over.
- 13.) Do not overload wall outlet. Use only power source as indicated.
- 14.) Use replacement parts as specified by the manufacturer.
- 15.) The product may be mounted to a wall only if recommended by the manufacturer.
- 16.) Upon completion of any service or repairs to this product, ask the service technician to perform safety checks.



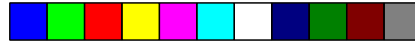

## **Congratulations!**

And thank you for purchasing the SmartSet® Clock Radio from Emerson Research. SmartSet® is the world's first and only LED clock radio that will automatically set itself to the correct 'Year', 'Month', 'Date', 'Day', and 'Time' as soon as you plug it in. The only thing you have to do is tell the SmartSet® what time zone you are in, and the built in computer does everything else for you immediately. And not only the first time, but every time the power is interrupted as well.

We all know how annoying it is to wake up in the morning and see the dreaded flashing "12:00" display on our clocks or clock radios. This means that your power was interrupted some time during the night while you were sleeping and your clock doesn't know what time it is anymore. Unfortunately it probably also means that you are late for work, or for school, again. But with your SmartSet® Clock Radio the dreaded flashing "12:00" display is a thing of the past. The SmartSet® resets itself as soon as the power is restored and gets you up on time, every time.

And if that isn't enough, the SmartSet® computer also knows when Daylight Saving Time begins and ends and it will adjust itself for those changes automatically through the year 2099! Leap Years too! And best of all, the long life lithium battery backup battery is already installed in your radio. You don't have to remember to put a new 9-volt battery in your radio every 6 months. Under normal circumstances the lithium battery can last for up to 5 years, and when it does need to be changed, a low battery indicator will come on to let you know. The CR2430 lithium battery is available almost anywhere that batteries are sold.

The SmartSet® also gives you dual alarms that can be set to go off on weekdays only, weekends only, or all 7 days. You can set one alarm to wake you up to buzzer Monday through Friday when you have to get up early, and use the second alarm to wake you up to soft music on Saturday and Sunday when you can sleep in.

Someday all clocks and clock radios may be this smart. But today the technology is only available from Emerson Research.

We're sure you'll be happy and amazed by your SmartSet® Clock Radio, and that it will give you many years of enjoyment and dependable service.

Once again, all of us at Emerson Research thank you for your purchase.



## IMPORTANT NOTES

- Avoid installing this unit in places exposed to direct sunlight or close to heat radiating appliances such as electric heaters, on top of other stereo equipment that radiates too much heat, places lacking ventilation or dusty areas, places subject to constant vibration and/or humid or moist areas.
- Operate controls and switches as described in the manual.
- Before turning on the power, make certain that the AC power cord is properly installed.
- When moving the set, be sure to first disconnect the AC power cord.

---

### FCC Information

This equipment has been tested and found to comply with the limits for a Class B digital device, pursuant to Part 15 of the FCC Rules. These limits are designed to provide reasonable protection against harmful interference in a residential installation. This equipment generates, uses, and can radiate radio frequency energy and, if not installed and used in accordance with the instructions, may cause harmful interference to radio communications. However, there is no guarantee that interference will not occur in a particular installation. If this equipment does cause harmful interference to radio or television reception, which can be determined by turning the equipment off and on, the user is encouraged to try to correct the interference by one or more of the following measures:

- Reorient or relocate the receiving antenna.
- Increase the separation between the equipment and receiver.
- Connect the equipment into an outlet on a circuit different from that to which the receiver is connected.
- Consult the dealer or an experienced radio/TV technician for help.

This device complies with Part 15 of the FCC Rules. Operation is subject to the following two conditions:

- (1) This device may not cause harmful interference, and
- (2) This device must accept any interference received, including interference that may cause undesired operation.

Changes or modifications not expressly approved by the party responsible for compliance could void the user's authority to operate the equipment.

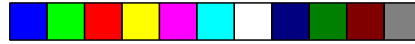

## PREPARATION FOR USE

### Unpacking And Set Up

- Remove the radio from the carton and remove all packing material from the radio. We suggest that you save the packing material, if possible, in the unlikely event that your radio ever needs to be returned for service. The original carton and packing material is the only safe way to pack your radio to protect it from damage in transit.
- Remove any descriptive labels or stickers on the front or top of the cabinet. Do not remove any labels or stickers from the back or bottom of the cabinet.
- Note the serial number on the bottom of your radio and write this number in the space provided on Warranty page of this manual.
- Place your radio on a level surface such as a table, desk or shelf, convenient to an AC outlet, out of direct sunlight, and away from sources of excess heat, dirt, dust, moisture, humidity, or vibration.
- Unwind the AC power cord and extend it to its full length. The FM antenna is built in to this cord. It must be fully extended to provide the best FM reception.

### Protect Your Furniture

This model is equipped with non-skid rubber 'feet' to prevent the product from moving when you operate the controls. These 'feet' are made from non-migrating rubber material specially formulated to avoid leaving any marks or stains on your furniture. However certain types of oil based furniture polishes, wood preservatives, or cleaning sprays may cause the rubber 'feet' to soften, and leave marks or a rubber residue on the furniture. To prevent any damage to your furniture we strongly recommend that you purchase small self-adhesive felt pads, available at hardware stores and home improvement centers everywhere, and apply these pads to the bottom of the rubber 'feet' before you place the product on fine wooden furniture.

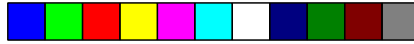

## Power Source

This radio is designed to operate on normal 120V 60Hz AC power only. Do not attempt to operate the radio on any other power source. You could cause damage to the radio that is not covered by your warranty.

This radio should be connected to an AC outlet that is always 'live'. Do not connect it to an outlet that is controlled by a wall switch. When the power to the radio is interrupted, the built in lithium battery takes over to maintain the time and alarm settings. To maximize the life of the lithium battery keep the radio connected to a 'live' AC outlet at all times.

You will note that this system is equipped with a polarized AC power plug having one blade wider than the other. This is a safety feature. If this plug does not fit into your existing AC outlet, do not try to defeat this safety feature by filing the wide blade to make it fit into your outlet. If this plug will not fit into your outlet, you probably have an out-dated non-polarized AC outlet. You should have your outlet changed by a qualified licensed electrician.

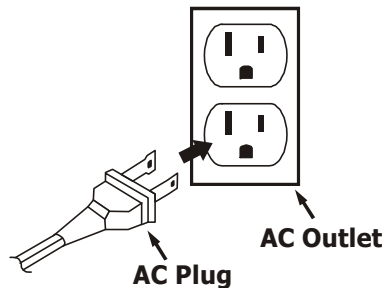

## Sure Alarm battery Back-Up System

This SmartSet® Clock Radio includes a Sure Alarm battery back-up circuit that can wake you up even if the power is 'Off' at the selected wake up time. If your power is 'Off' at the selected wake up time the clock display will be off and the radio will not operate, but a separate mini-buzzer will turn 'On' automatically to wake you up, even if you had selected the "Wake to Radio" option.

The Sure Alarm will sound for 30 seconds and then shut off automatically.

To stop the Sure Alarm buzzer immediately, press the **RADIO ON/OFF** button. Pressing the **SNOOZE** button has no effect during Sure Alarm operation.

**Note:** *In order to maximize the life of the built in lithium battery, please be sure to set the **ALARM 1** and **ALARM 2** switches to the "OFF" position if the radio will be disconnected from the AC outlet for more than a few hours. This will prevent the Sure Alarm from turning 'On' unnecessarily.*



# LOCATION OF CONTROLS AND INDICATORS

## Front Panel

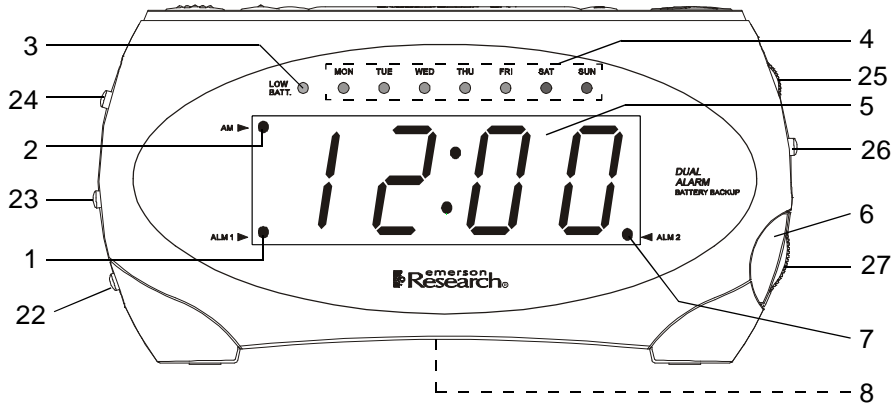

## Top Panel

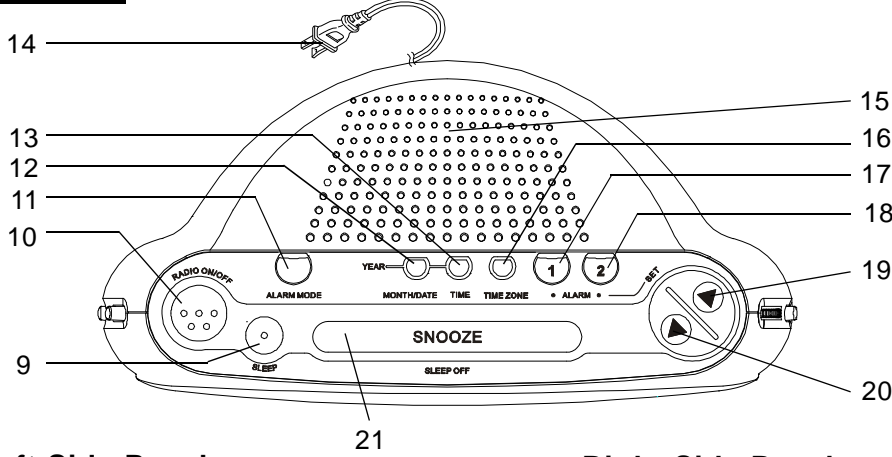

## Left Side Panel

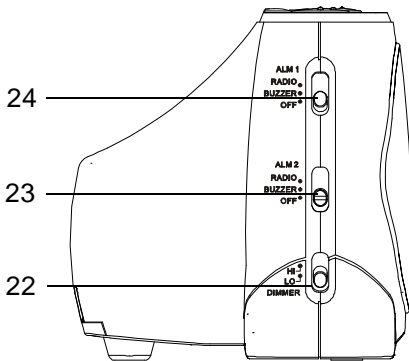

## Right Side Panel

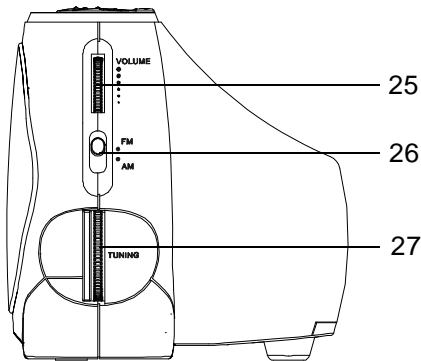

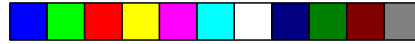

- 1.) **ALM 1** 'On' Indicator.
- 2.) **AM** Indicator.
- 3.) **LOW BATT.** LED Indicator.
- 4.) Day LED Indicators.
- 5.) Time/Date Display.
- 6.) Dial Scale.
- 7.) **ALM 2** 'On' Indicator.
- 8.) Back Up Battery Compartment (Bottom Cabinet).
- 9.) **SLEEP** Button (Sleep To Music Timer).
- 10.) **RADIO ON/OFF** Button.
- 11.) **ALARM MODE** (Weekdays/Weekends/Everyday Alarm) Button.
- 12.) **MONTH/DATE** Setting Button.
- 13.) **TIME** Button.
- 14.) AC Power Cord (Back Cabinet).
- 15.) Speaker.
- 16.) **TIME ZONE** Button.
- 17.) **ALARM 1** setting Button.
- 18.) **ALARM 2** setting Button.
- 19.) **SET** ▼ (Up) Button.
- 20.) **SET** ▲ (Down) Button.
- 21.) **SNOOZE (SLEEP OFF)** Button.
- 22.) Display **DIMMER (HI/LO)** Switch.
- 23.) **ALM 2 (RADIO/BUZZER/OFF)** Selector Switch.
- 24.) **ALM 1 (RADIO/BUZZER/OFF)** Selector Switch.
- 25.) **VOLUME** Control.
- 26.) Radio Band (**AM/FM**) Switch.
- 27.) **TUNING** Control.





# OPERATING INSTRUCTIONS

## Setting The Time, The First Time

**IMPORTANT:** The first time you connect your new SmartSet® clock radio to the AC outlet the internal computer will automatically set the time correctly for the **Eastern Time Zone**, which is the initial default setting. The display will scan for a few seconds and then show the correct **Day** and **Time** in the Eastern zone. If you live in the Eastern Time zone, there's nothing else to do. Your clock is set correctly and running.

If you do not live in the Eastern Time zone you must change the default zone display to your own zone. You only do this one time and the SmartSet® will remember the new default zone setting and will always return to that setting after a power interruption

There are 7 time zones programmed into your SmartSet® clock radio as follows:

- ZONE 1 — Atlantic Time
- ZONE 2 — Eastern Time (Default Setting)
- ZONE 3 — Central Time
- ZONE 4 — Mountain Time
- ZONE 5 — Pacific Time
- ZONE 6 — Yukon Time
- ZONE 7 — Hawaiian Time

To change the default time zone display, depress the **TIME ZONE** button.

The number "2" will appear on the display indicating that the default zone is ZONE 2, Eastern Time.



Hold the **TIME ZONE** button and then press either the **SET** ▼(Up) or **SET** ▲(Down) buttons until your own time zone appears on the display, then release the buttons. The clock display will change to the correct time in the time zone you selected. The clock will always return to the correct time in the zone you selected after every power interruption. If you move to a different time zone, simply change the default zone display to the new zone and the SmartSet® will remember that setting for you.



## Date Display

To see the correct Date at any time, depress the **MONTH/DATE** button.

The display changes from Time to Month and Date (MM/DD).

For example, May 21<sup>st</sup> will appear as “5 21”.



When you release the **MONTH/DATE** button the display returns to the correct Time.

## Year Display

To see the correct Year, depress the **MONTH/DATE** and **TIME** buttons together.

The display changes from Time to Year.



When you release the **MONTH/DATE** and **TIME** buttons the display returns to the correct Time.

## Daylight Saving and Leap Year Adjustments

All Daylight Saving and Leap Year adjustments are made automatically by the SmartSet<sup>®</sup> internal computer as follows:

- **Start of Daylight Saving Time:**  
At “2:00 AM” on the 2nd Sunday in March, the clock will automatically advance to “3:00 AM”.
- **End of Daylight Saving Time:**  
At “3:00 AM” on the 1st Sunday in November, the clock will automatically reset to “2:00 AM”.
- **Leap Year:**  
At “12:00 Midnight” on February 28<sup>th</sup>, the calendar display will change to “2 29”.

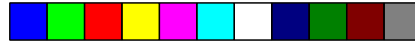

## Manual Time Adjustments

Some people like to set their clocks 5 to 10 minutes fast to make sure that they will always be on time. Even though the SmartSet® sets the time by itself, you still have the option of adjusting the time manually if you wish.

To manually adjust the time display depress and hold the **TIME** button, and press either the **SET** ▼(Up) or **SET** ▲(Down) buttons to adjust the time display ahead or back as desired.

Each press of the **SET** ▼(Up) or **SET** ▲(Down) buttons will change the display by one minute.

If you hold the **SET** ▼(Up) or **SET** ▲(Down) buttons the display will continue to change. The display will change slowly at first, one minute at a time.

But if you continue holding the **SET** ▼(Up) or **SET** ▲(Down) buttons the display will change rapidly.

**Note:** *If you manually adjust the time, your new setting is entered into the SmartSet® memory. If the power is interrupted, the display will return to your new setting, not the original setting, when the power is restored.*



## Adjusting The Wake Up Times

Your SmartSet® clock radio has two separate alarms that can be set and used independently. You may use the alarms to wake two people at different times, or you may use one alarm for weekdays and the other for weekend wake up times. The procedure for adjusting the wake up time is the same for both Alarm 1 and Alarm 2.

- 1.) Depress and hold either the **ALARM 1** or **ALARM 2** setting button. The display will change from the correct time to the Alarm 1 or Alarm 2 wake up time.

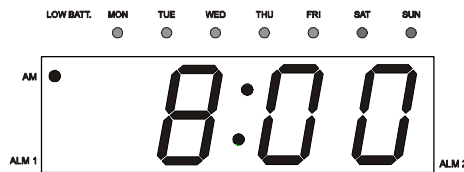

- 2.) While holding the **ALARM 1** or **ALARM 2** setting button, depress either the **SET ▼**(Up) or **SET ▲**(Down) button to move the display ahead or back to your desired wake up time.
- 3.) When the desired wake up time appears on the display, release the **SET ▼**(Up) or **SET ▲**(Down) buttons.

**Note:** Be sure that you have set the wake up time correctly by observing the AM indicator. If the **AM** indicator is 'On' the wake up time is "AM". If the AM indicator is 'Off', the wake up time is "PM".

- 4.) When the desired wake up time (AM or PM) appears on the display, release the **ALARM 1** or **ALARM 2** setting buttons.

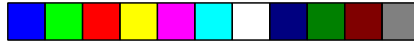

## Selecting The Alarm Mode

Your SmartSet® clock radio allows you to select from among three different alarm operation modes for either alarm. The alarm modes are:

- **Everyday** – The alarm will turn on all 7 days.
- **Weekdays only** – The alarm will only turn on Monday through Friday;
- **Weekends only** – The alarm will only turn on Saturday and Sunday.

To check the Alarm Mode setting for Alarm 1, depress the **ALARM 1** setting button. The display will show the Alarm 1 wake up time and the “Day Of The Week” indicators will show you the alarm mode which is selected.

- If all 7 indicators are ‘On’, the Everyday mode is selected.

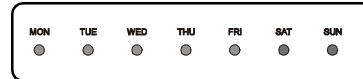

- If only the Monday through Friday indicators are ‘On’, the Weekdays only mode is selected.

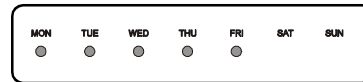

- If only the Saturday and Sunday indicators are ‘On’, the Weekends only mode is selected.

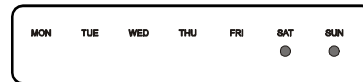

To change the Alarm Mode setting for Alarm 1, hold the **ALARM 1** setting button and press the **ALARM MODE** button until the Day indicators show the desired mode setting, Weekdays only, Weekends only, or Everyday operation.

Release the **ALARM MODE** and **ALARM 1** setting buttons and the display will return to the correct time.

Follow the same procedure to select the desired Alarm Mode for Alarm 2 if necessary.

## Checking The Wake Up Times And Alarm Mode

Whenever you want to check the wake up time or the alarm mode settings, simply press either the **ALARM 1** or **ALARM 2** setting buttons. The display will change from correct time to wake up time and the day indicators will show you the alarm mode which is currently selected.

Release the **ALARM 1** or **ALARM 2** setting buttons to return to correct time.



## Listening To The Radio

- 1.) Set the Band selector to the desired band, **AM** or **FM**.
- 2.) Set the **VOLUME** control to a low setting.
- 3.) Press the **RADIO ON/OFF** button to turn the radio 'On'.
- 4.) Select your desired station with the **TUNING** control on the right side of the cabinet.
- 5.) Adjust the **VOLUME** control to the desired setting.
- 6.) When you are finished listening, press the **RADIO ON/OFF** button to turn the radio 'Off'. The radio dial pointer light goes off.

## Antenna Information

**AM** – The AM bar antenna is inside the cabinet. If AM reception is weak, change the position of cabinet until the internal antenna picks up the strongest signal.



**FM** – The FM antenna is built in to the AC power cord. If FM reception is weak try varying the position and direction of the power cord until you find the strongest signal.



## Wake To Radio

- 1.) Turn the radio 'On' and select the band, station, and volume level that you wish to hear when the alarm comes on, then turn the radio 'Off' again.
- 2.) Reconfirm the wake up time and alarm mode settings for the alarm you are using, Alarm 1, Alarm 2, or both alarms.

- 3.) Set the **ALM** selector switch for one or both alarms to the "**RADIO**" position. The appropriate **ALM 1** and/or **ALM 2** indicators will light up to confirm that the alarms are set.

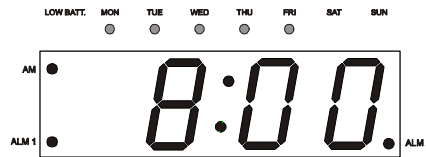

- 4.) At the selected wake up time the radio will turn 'On'. It will play for one hour and then shut off automatically.
- 5.) To stop the radio sooner, press either the appropriate **ALARM 1** or **ALARM 2** button, or press the **RADIO ON/OFF** button. The radio will stop but the alarm remains set and will turn the radio on again at the same time on the following day (depending on the Alarm Mode setting).
- 6.) If you do not want the alarm to turn the radio on the following day, set the appropriate **ALM** selector to the "**OFF**" position.

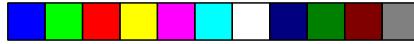

## Wake To BUZZER (Crescendo Alarm)

**Note:** Alarm 1 and Alarm 2 have different buzzer sounds.

- Alarm 1 is a “Single beep” sound.
- Alarm 2 is a “Double beep” sound.

You will be able to tell which alarm is going off by the sound that it makes.

- 1.) Reconfirm the wake up time and alarm mode settings for the alarm you are using, Alarm 1, Alarm 2, or both alarms.
- 2.) Set the **ALM** selector switch for one or both alarms to the **BUZZER** position. The appropriate **ALM 1** and/or **ALM 2** indicators will light up to confirm that the alarms are set.
- 3.) At the selected wake up time the buzzer will sound. It will begin softly and gradually increase in volume to wake you up. It will continue for one hour and then shut off automatically.
- 4.) To stop the buzzer sooner, press either the appropriate **ALARM 1** or **ALARM 2** button. The buzzer will stop but the alarm remains set and will turn the buzzer on again at the same time on the following day (depending on the Alarm Mode setting).
- 5.) To stop the buzzer and turn on the radio immediately, press the **RADIO ON/OFF** button instead of the **ALARM 1** or **ALARM 2** button.
- 6.) If you do not want the alarm to turn the buzzer on the following day, set the appropriate **ALM** selector to the “**OFF**” position.

## Radio And Buzzer Operation

You may also set one alarm for “Wake To Radio” and the other for “Wake To Buzzer”. Just set the **ALARM 1** and **ALARM 2** selector switches to the desired positions.

## Snooze Alarm

After the radio or buzzer alarm sounds in the morning you may press the **SNOOZE** Bar for a few more minutes sleep. The respective **ALM** indicator will flash.

The alarm will stop for approximately 9 minutes and then turn on again. You may repeat the Snooze operation up to seven times if desired, but after the seventh time the alarm will not turn on again.



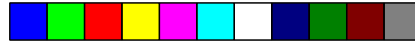

## Sleep To Music Timer

You can program the Sleep Timer to play the radio for up to 90 minutes and then shut off automatically.

- 1.) Press the **SLEEP** button. The display will briefly show “10” and the radio will begin to play.



After 10 minutes the radio will shut off automatically. Each time you press the **SLEEP** button the Sleep Timer will start at 10 minutes. This is the Sleep Timer default setting.

- 2.) To increase or decrease the amount of time that the radio will play before shutting off, hold the **SLEEP** button and press either the **SET** ▼(Up) or **SET** ▲(Down) button to change the display to the desired Sleep Time, up to a maximum of 90 minutes or a minimum of 2 minutes.

**Note:** When you change the Sleep Timer from the 10 minute default setting to a different setting, the new setting becomes the default setting. Whenever you activate the Sleep Timer it will begin with your new default setting and count down to zero from that point.

- 3.) To cancel the Sleep Timer before it counts down to “00” and shut the radio ‘Off’ immediately, press the **SNOOZE** Bar.

**IMPORTANT:** Remember that the station and volume settings you choose for the Sleep To Music operation are the same settings you will hear if you set the alarm for Wake To Radio the following morning.

## Dimmer Control

The **DIMMER** control was set to the **HI** (High) position at our factory.

If you find the clock display is too bright in a darkened room, set the **DIMMER** control to the **LO** (Low) position.



## Changing The Lithium Battery

Like all batteries, eventually the built in lithium battery will need to be replaced. A number of factors, such as, the length of time between the date the radio was manufactured and the date you plugged it in for the first time determine the amount of time before replacement. During this initial storage period, the lithium battery is supplying power to the SmartSet® computer memory. Once you plug the radio in, your household outlet supplies the power, and the battery is not being used.

A fresh lithium battery can supply power to the SmartSet® computer for at least 3 years even if it is never connected to an AC power supply. If your radio was connected to your AC supply within a few months after it was manufactured, and you experience only the normal, nuisance type, short duration power interruptions, your battery may last for up to 5 years or even longer.

When the battery power drops below a certain level, the **LOW BATT.** indicator will 'flash'. When you see this indicator, you should change the battery as soon as it is convenient for you to do so.

To change the battery proceed as follows:

- 1.) Purchase a replacement 3V lithium battery wherever batteries are sold. The battery type is **CR2430** or equivalent.
- 2.) Remove the battery from its package so it is ready to install.

**IMPORTANT:** Leave the radio power cord connected to your AC outlet. This will provide power to the SmartSet® computer memory while the original lithium battery is removed.

- 3.) Turn the radio face down and use a small screwdriver to remove the small screw securing the battery holder to the cabinet.

**BE CAREFUL NOT TO LOSE THIS SMALL SCREW!**

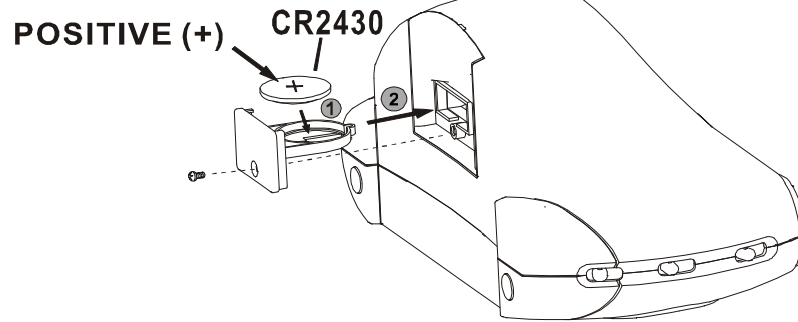
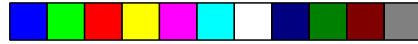

- 4.) Remove the original battery from the holder and insert the new battery into the holder the same way, observing the positive (+) direction. Slide the holder with the new battery back into the slot in the cabinet.
- 5.) Replace the screw that secures the battery holder in the cabinet.
- 6.) Turn the radio right side up and confirm that the **LOW BATT.** indicator is 'Off'.
- 7.) Save these instructions. You'll have to do this again five to eight years from now!



## Resetting The Clock After A Total Memory Loss

If you do not change the built in lithium battery within a reasonable period of time after you see the 'flashing' **LOW BATT.** warning indicator, the lithium battery may become exhausted and will no longer be able to supply back up power to the SmartSet® internal computer. If the unit is disconnected from the AC outlet after the battery is exhausted, or if a power interruption occurs, the SmartSet® memory will be lost and the clock will need to be reset when the power is restored.

Be sure to install a fresh lithium battery before you reset the clock, otherwise the clock will need to be reset each time the power is interrupted.

If the lithium battery is exhausted and you experience an interruption in the AC power supply, the clock will reset itself to its initial default setting when the power is restored.

The initial default setting is "**12:00 AM, Saturday, January 1<sup>st</sup> (1 1), 2005**".

If you notice that the time on your SmartSet® clock radio is completely incorrect, and the Day indicator is also wrong, press the **MONTH/DATE** button to see the Date.

If the Date display is showing "**1 1**" (January 1<sup>st</sup>), you probably experienced a total memory loss.



To reset the clock after a total memory loss, proceed as follows:

- 1.) Follow the instructions on pages 17, 18 and install a new **CR2430** lithium battery in the battery compartment.
- 2.) Connect the radio to your AC outlet and let the clock set itself.
- 3.) Depress the **MONTH/DATE** and **TIME** buttons together. The display will change from 'Time' to 'Year'.

While holding the **MONTH/DATE** and **TIME** buttons, press the **SET** ◀(Up) button to set the display to the correct year, then release the buttons.



4.) Depress the **MONTH/DATE** button. The display will change from 'Time' to 'Month/Date' (MM/DD).

While holding the **MONTH/DATE** button, press the **SET** ▼(Up) button to set the display to the correct Month and Date. The Day indicator will change automatically as you adjust the Month/Date settings. When the correct Month and Date appear on the display, release the buttons.

5.) Depress the **TIME** button and the **SET** ▼(Up) button to set the display to the correct Time. Be sure to confirm that you have set the time correctly to 'AM' or 'PM' by observing the **AM** indicator.

6.) After you set the time, reconfirm that the Day, and Month/Date displays are still correct. Make final adjustments if necessary.

The SmartSet<sup>®</sup> clock memory is now reset and the new lithium battery will maintain it for the next 5 to 8 years, depending on the number and duration of the power outages you experience.



### **IMPORTANT NOTE**



*After resetting the clock, don't forget to reset your wake up times, and alarm mode settings, and sleep timer settings as well.*



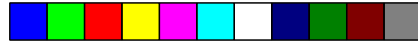

## CARE AND MAINTENANCE

### Care Of Cabinets

If the cabinet becomes dusty, wipe it with a soft cloth. If the cabinet becomes smudged or dirty, clean it with a soft, slightly dampened cloth.

Never allow water or any liquid to get inside the cabinet. Never use any abrasive cleaners or cleaning pads as these will damage the finish of your clock radio.

### Lithium Battery Precautions

- *Dispose of the old battery properly. Do not leave it lying around where a young child or pet could play with, or swallow it. If the battery is swallowed, contact a physician immediately.*
- *Battery may explode if mistreated. Do not attempt to recharge it or disassemble it. Do not dispose of the old battery in a fire.*

	TO FIND THE LOCATION AND PHONE NUMBER OF YOUR NEAREST SERVICE CENTER PERMITTED TO PERFORM WARRANTY...
CALL TOLL FREE: 1-800-695-0098	
FOR ADDITIONAL SET-UP OR OPERATING ASSISTANCE PLEASE CALL: 1-800-898-9020	
FOR CUSTOMER SERVICE, PLEASE WRITE TO: Emerson Radio Corp., Consumer Affairs Dept., 5101 Statesman Drive, Irving, TX 75063.	



**LIMITED WARRANTY**

Emerson Radio Corp. warrants manufacturing defects in original material, including original parts and workmanship, under normal use and conditions, for a period of ninety (90) days from the date of original purchase in the U.S. With your dated proof of purchase, we will provide repair service at no charge for labor and parts at an authorized Depot Repair Facility, or replace the product in our discretion. For repair or replacement, pack your unit in a padded box, enclose your check or money order payable to Emerson Radio Corp. in the amount of \$9.00 (not required by California residents) to cover shipping and handling costs, and enclose a copy of your proof of purchase. Send your unit to:

Emerson Radio Corp.,  
5101 Statesman Drive,  
Irving, TX 75063.

This warranty does not cover damage from negligence, misuse, abuse, accident, failure to follow operating instructions, commercial use, rental, repairs by an unauthorized facility, or products purchased, used, serviced or damaged outside of the United States.

**THIS WARRANTY GIVES YOU SPECIFIC LEGAL RIGHTS, AND YOU MAY ALSO HAVE OTHER RIGHTS WHICH VARY FROM STATE TO STATE.**

**AU898M**

The Serial Number can be found on the bottom cabinet. We suggest that you record the Serial Number of your unit in the space below for future reference.

**Model Number: CKS2862**

**Serial Number:** \_\_\_\_\_



 **emerson**  
**Research**®



CKS2862-061207-01

Printed in China



CKS2862\_061207.p65

23



12/6/2007, 15:54

