



TRANE®

Controls Programming Guide

Direct-Fired Indoor and Outdoor Make-Up Air Units



DFIA
DFOA

January 2007

MUA-SVP01A-EN



Overview

A glossary has been provided to assist the reader in understanding distinctive terms and phrases. These terms and phrases appear in italics.

Trane's Digital Control System, AdaptAire, is designed to give the user the ultimate in unit performance and operational flexibility, adaptability, and reliability in a user-friendly package. The AdaptAire DDC system is a standard component on Trane heating and cooling units. Non-recirculating units, equipped with the AdaptAire system, do not have return air capabilities, and all functions related to recirculating units are not relevant. Where a function is similar but different between recirculating and non-recirculating units, the function is explained separately.

AdaptAire accepts single or multiple units on the system network. Each unit can be provided with a local user interface. The operating parameters for individual units may be input through the local interface. A PC may also be connected to the network. This allows the user to configure each unit separately, or all units can be configured simultaneously. A controls contractor can provide assistance in networking.

Operational modes include time scheduling, filter monitoring, and multiple damper control and temperature control schemes. All of these modes provide the maximum in unit operational flexibility.

The optional airflow station imparts unparalleled adaptability into the operation of each unit. A daily self-calibration enables AdaptAire to detect the total air volume and the exact ratio of outside and return air entering the unit. Then AdaptAire daily fine-tunes the unit's operation based on these new parameters. Air volume can vary because of changes in static pressure conditions due to loading filters, VAV boxes, and building dynamics. These varying conditions influence the ventilation air provided by the unit. On certain models of recirculating direct-fired heaters this impacts the allowable equivalent temperature rise of the unit that is allowed under the latest ANSI standard for direct-fired heaters.

AdaptAire diagnostic capabilities insure swift response to abnormal unit conditions. A fault is generated anytime the operational parameters and actual unit operation are at odds. An indication of trouble is displayed at the local user interface and system PC in text format. In the Diagnostics section of this manual is a list of all faults and possible causes and solutions.

All of the features of the AdaptAire system are designed to provide the user with real time information. At any time the user can display all of the operational parameters, make changes, if necessary, and observe the various temperature, pressure, and damper readings. The system's diagnostic capabilities provide the user with up to the minute status reporting. (BACview service module or WebCTRL internet connection is required for these features.)



NETWORKING

AdaptAire is adaptable to a variety of different network architectures and protocols. Each controller has built-in protocol translation and can be configured for operation on ARCnet156 or EIA-485 communication networks. See Appendix IV for specific controller specifications.

The AdaptAire system can be connected to most existing building automation systems. Some systems may require the use of special controllers and network communication devices. See Appendix I for Device Parameters and Cache Setup information.

ADAPTAIRE DEFAULT SETTINGS

The following is a list of AdaptAire DDC controller defaults. These are the default operating parameters set at the factory prior to shipment.

Table 1. Default settings

ITEM	DEFAULT	RANGE
Unit Network Address	002 binary dips	000 – 255 binary dips
Unit Operating Mode	OFF	OFF – MANUAL - AUTO
Time Clock Schedule	None	4 Daily - 12 Holiday - 2 Override schedules
Heating/Cooling Operating Mode	Heating	HEATING - COOLING
Damper Operating Mode	Manual	MANUAL - BUILDING PRESS - MIXED AIR TEMP
Fuel Selection	Natural Gas	NATURAL - PROPANE
Heating Night Setback	55°F	40°F - 80°F
Cooling Night Setback	100°F	75°F - 120°F
Room Temperature Setpoint	65°F	55°F - 90°F
Freezestat	45°F	35°F - 50°F
Outside Air Economizer Setpoint	65°F	40°F - 80°F
Minimum Discharge Temperature Setpoint	55°F	40°F - 130°F
Maximum Discharge Temperature Setpoint	100°F	55°F - 130°F
Mixed Air Temperature Setpoint	50°F	30°F - 90°F
Building Pressure Setpoint	0" W. C.	-0.05" - +0.05" W. C.
Manual Damper Position Setpoint	20% Outside Air	0% - 100%
Minimum Ventilation Setpoint	20% Outside Air	0% - 100%
User PID Select	Direct Acting	DIRECT -REVERSE
High Input Value	0	-9999.99 – 99999.99



Table 1. Default settings (continued)

ITEM	DEFAULT	RANGE
Low Input Value	0	-9999.99 – 99999.99
User Control Setpoint	0	-9999.99 – 99999.99
Maximum User Setpoint	0	-9999.99 – 99999.99
Minimum User Setpoint	0	-9999.99 – 99999.99



Contents

NETWORKING	3
ADAPTAIRE DEFAULT SETTINGS	3
Unit Operating Modes	7
MDT Controls:	7
MRT Controls:	8
MRT-Pro Controls:	8
MRT-Expert Controls:	10
Heating/Ventilating/Cooling Operating Modes	12
Heating Mode	12
Ventilation Mode	14
Cooling Mode	15
Damper Control Modes	16
Manual Mode	16
Functions	19
100% Outside Air	19
Minimum Ventilation	19
Freezestat	19
Clogged Filter	19
User Configured PID Control	20
DIRECT ACTING	20
REVERSE ACTING	22
Unit Resets	24
Multiplexed Inputs	24
Clock Set	25
Diagnostics	26
Critical Fault Codes	26
FAULT CODE:	Low Discharge Temperature26
FAULT CODE:	Safety Circuit Open29
FAULT CODE:	Burner Status30
FAULT CODE: Burner Hand	31
FAULT CODE:	Flame Failure32
Diagnostics - Non-Critical Fault Codes	32
FAULT CODE:	Unit off/Fan on33
FAULT CODE:	Unit on/Fan off34
FAULT CODE:	Check Airflow Switches35
FAULT CODE:	Clogged Filter Switch36
FAULT CODE:	Energy Save Mode 137
FAULT CODE:	Energy Save Mode 238
FAULT CODE:	Energy Save Mode 339
FAULT CODE:	Insufficient OA40
Menu Selection	43
Menu Selection Tree for BACview	43
UNIT MODES HOTKEY - 2	43
SET POINTS HOTKEY - 3	44
STATUS MENU	HOTKEY - 445



Contents

ALARM	HOTKEY - 145
RESETS HOTKEY - 6	45
SCHEDULES HOTKEY- 7	46
USER CONFIGURABLE OUTPUT HOTKEY - 8.....	46
CLOCKSET	HOTKEY - 047
HELP HOTKEY - 5	47
FUEL SELECT HOTKEY - 9.....	48
Thermostat Output Curve	49
10 K Ohms Thermistor Output Curve	49
Airflow Station Layout	50
I/O Zone 583 Controller Specifications	51
Typical Wiring Schematic	53



Unit Operating Modes

There are three different modes that control the supply fan and unit operation:

- Off
- Manual
- Auto

There are also four different methods for controlling the operating modes:

- "a remote panel with two rotating knob adjustments (MDT and MRT controls)
- "a remote panel with one rotating knob and an intelligent room sensor (MRT-Pro controls)
- "an intelligent room sensor and local user interface panel with LCD display (MRT-Pro controls)
- any of the above controls with a internet-base WebCTRL interface.

MDT Controls:

MDT, modulating discharge temperature, is the most basic AdaptAire control for discharge temperature. The MDT control system includes a remote control panel equipped with 1 or 2 potentiometers, 3 or more pilot lights, and up to 2 switches.

UNIT OFF MODE

Off Mode is the default unit operational mode. To place the unit in the Off Mode, rotate the "temperature setpoint" knob on the remote control panel counterclockwise to the stop. This will place the unit in the OFF mode and extinguish the "unit enable" light. The OFF mode prevents the unit from starting

UNIT MANUAL MODE

Manual Mode allows the unit to turn on. To place the unit in the Manual Mode, rotate the "temperature setpoint" knob on the remote control panel clockwise to the desired discharge air temperature setpoint. This will place the unit in the MANUAL mode and enable the burner. See Heating/Ventilating/Cooling Modes and Energy Saving Modes of this manual for more information.

UNIT AUTO MODE

Auto Mode has four different functions that control the unit operation. They are a time clock, heating and cooling night setbacks, and a signal from an external source.

The MDT control does not support the time clock, night setback, or auxiliary unit enable functions.



Unit Operating Modes

MRT Controls:

MRT, modulating room temperature, is the most basic AdaptAire control for room temperature. The MRT control system includes a remote control panel equipped with 1 or 2 potentiometers, 3 or more pilot lights, and up to 2 switches.

UNIT OFF MODE

Off Mode is the default unit operational mode. To place the unit in Off Mode rotate the "temperature setpoint" knob on the remote control panel counterclockwise to the stop. This will place the unit in the OFF mode and extinguish the "unit enable" light. The OFF mode prevents the unit from starting.

UNIT MANUAL MODE

Manual Mode allows the unit to turn on. To place the unit in Manual Mode rotate the "temperature setpoint" knob on the remote control panel clockwise to the desired room temperature setpoint. This will place the unit in the MANUAL mode. The burner will be enabled if the room air temperature is 2° below the room temperature setpoint and will be deactivated when the room air temperature is above the room temperature setpoint. The cooling output will be enabled if the room air temperature is 2° above the room temperature setpoint and will be deactivated when the room air temperature is below the room temperature setpoint.

UNIT AUTO MODE

Auto Mode has four different functions that control the unit operation. They are a time clock, heating and cooling night setbacks, and a signal from an external source.

The MRT control does not support the time clock, night setback, or auxiliary unit enable functions.

MRT-Pro Controls:

The AdaptAire MRT-Pro, modulating room temperature control, provides some limited information regarding unit operation on an LCD display and allows the user to adjust a few basic operational parameters. The MRT-Pro must be placed in the MANUAL or AUTO mode in the controller program using a BACview or PC in order for it to operate. The Off, Manual, and Auto modes will then function as described in the following sections.

UNIT OFF MODE

Off Mode is the default unit operational mode. The OFF mode prevents the unit from starting and overrides the Time Clock and Night Setback functions. A BACview or PC is required to change from this mode. See the section related to the MRT Expert for instructions on how to use the BACview for programming.



Unit Operating Modes

UNIT MANUAL MODE

Manual Mode allows the unit to turn on regardless of the Time Clock or Night Setback functions. A BACview or PC is required to change to this mode. See the section related to the MRT Expert for instructions on how to use the BACview for programming.

UNIT AUTO MODE

Auto Mode has four different functions that control the unit operation. They are a time clock, heating and cooling night setbacks, and a signal from an external source. A BACview or PC is required to change to this mode. See the section related to the MRT Expert for instructions on how to use the BACview for programming.

Unoccupied/Occupied Control. Once the unit is placed in the Auto Mode, the unit can be controlled from the keypad on the MRT-Pro room sensor. The MRT-Pro room sensor display will indicate the unit is in the un-occupied period. To turn the unit on and place it in the occupied period press the "Manual On" button on the face of the MRT-Pro room sensor. Pressing the "Warmer" button can increase the amount of "on" time. Pressing the "Cooler" button can decrease the amount of "on" time. Each press decreases the time in 30-minute increments. Each press increases the time in 30-minute increments to a maximum of 9 hours of "on" time.

To turn the unit off and place it in the un-occupied period press the "Manual On" button on the face of the MRT-Pro room sensor. The display will indicate the amount of "on" time remaining. Press the "Cooler" button repeatedly until the time reaches zero, and the unit shuts off. Each press decreases the time in 30-minute increments.

Auto Mode has four different functions that control the unit operation. They are a time clock, heating and cooling night setbacks, and a signal from an external source.

Scheduling Time Clock. This function requires the purchase of a BACview or a direct PC interface to the unit controller. See the section related to the MRT Expert for instructions on how to use the BACview for programming.

Heating Night Setback. The Heating Night Setback function automatically cycles the unit "on" if the room temperature falls below the Heating Night Setback temperature setpoint, and the unit is scheduled to be "off". If the unit is scheduled to be "off" and the Heating Night Setback function turns the unit "on", the unit will be cycled "off" once the room air temperature has risen 2° above the Heating Night Setback setpoint. The default for this setpoint is 55°F and is fixed at 10° below the Heating setpoint. Changing the Heating setpoint changes the Heating Night Setback setpoint

Cooling Night Setback. The Cooling Night Setback function automatically cycles the unit "on" if the room temperature rises above the Cooling Night Setback temperature setpoint, and the unit is scheduled to be "off". If the unit is scheduled



Unit Operating Modes

to be "off" and the Cooling Night Setback function turns the unit "on", the unit will be cycled "off" once the room air temperature has fallen 2° below the Cooling Night Setback setpoint. The default for this setpoint is 100°F and is fixed at 27° above the Cooling setpoint. Changing the Cooling setpoint changes the Cooling Night Setback setpoint.

Auxiliary Unit Enable. The Auxiliary Unit Enable function overrides all other Auto Mode functions and automatically cycles the unit into operation. This function is activated whenever a contact is closed between the appropriate terminals on the unit's terminal strip located in the unit's main control panel. See the Typical Wiring Schematic and Multiplexed Input sections of this manual for more information. This function can be used with a twist timer, toggle switch, door switch, exhaust fan interlock, or any other dry contact to override the time clock schedule.

MRT-Expert Controls:

The AdaptAire MRT-Expert, modulating room temperature control, provides full information regarding unit operation and allows the user to adjust all operational parameters using the included BACview panel.

UNIT OFF MODE

Off Mode is the default unit operational mode. To place the unit in Off Mode scroll through the Unit Modes menu tree, locate the AUTO/OFF/MANUAL branch, and select OFF. This will place the unit in the OFF mode. The OFF mode prevents the fan and burner from starting. This mode will override the Time Clock and Night Setback functions.

UNIT MANUAL MODE

Manual Mode allows the supply fan to turn on regardless of the Time Clock or Night Setback functions. Heating and cooling functions use the Night Setback Setpoints. To place the unit in Manual Mode scroll through the Unit Modes menu tree, locate the AUTO/OFF/MANUAL branch, and select MANUAL. This will place the unit in the MANUAL mode.

UNIT AUTO MODE

Auto Mode has four different functions that control the supply fan and unit operation. They are a time clock function, heating and cooling night setbacks, and a signal from an external source to an auxiliary digital input. To place the unit in Auto Mode scroll through the Unit Modes menu tree, locate the AUTO/OFF/MAN branch, and select AUTO. This will place the unit in the AUTO mode. This activates the four Auto mode functions.

Scheduling Time Clock. The primary Auto Mode function is the Time Clock Schedule. The Time Clock function allows the user to schedule the operational times of the unit. There are four different schedules available: 24 hour continuous operation, daily, holiday, and override. The daily schedule can be programmed



Unit Operating Modes

for up to 4 separate On/Off events with any combination of days. The normal schedule sets the typical On/Off times for the unit. The holiday schedule can be programmed for up to 12 separate On/Off events with any combination of days. The holiday schedule sets the Off times for holidays and other shutdown periods. The override schedule can be programmed for up to 2 separate On/Off events with any combination of days. The override schedule sets the On times that will override the holiday schedule. This scheduling system allows the user to program a diverse array of On/Off operations. An example of a typical schedule would be to have the unit On Monday through Friday from 6:00 AM to 5:00 PM, except during the weeks of Thanksgiving and Christmas when the units will be Off. However they will run each weekday during the Thanksgiving shutdown from 8:00 AM until noon while a maintenance crew is in the building. AdaptAire has no preset operational schedule.

To set the time clock function for 24 hour continuous operation scroll through the menu tree and locate the SCHEDULES page. Set the 24 Hr Operation to yes. Enter the Daily section of the menu and set the Use tab to yes. Finally select the days for 24 hour operation.

To set the operational times of the unit scroll through the SCHEDULES menu tree, and locate the desired Daily, Holiday, or Override branch. Enter the days and times for the unit to operate. In the Daily or Override section these times should correspond to the desired "on" times for the unit's operation. In the Holiday section these times should correspond to the desired "off" times for the unit's operation.

See the CLOCK SET section of this manual for setting the time, date and Daylight Savings function.

Heating Night Setback. The Heating Night Setback function automatically cycles the unit "on" if the room temperature falls below the Heating Night Setback temperature setpoint, and the unit is scheduled to be "off". If the unit is scheduled to be "off" and the Heating Night Setback function turns the unit "on", the unit will be cycled "off" once the room air temperature has risen 2° above the Heating Night Setback setpoint. The default for this setpoint is 55°F. To change the Heating Night Setback setpoint scroll through the SETPOINTS menu tree, locate the Heating Night Setback setpoint and enter a new temperature. The allowable temperature range is 40°F - 80°F.

Cooling Night Setback. The Cooling Night Setback function automatically cycles the unit "on" if the room temperature rises above the Cooling Night Setback temperature setpoint and the unit is scheduled to be "off". If the unit is scheduled to be "off" and the Cooling Night Setback function turns the unit "on", the unit will be cycled off once the room air temperature has fallen 2° below the Cooling Night Setback setpoint. This function toggles digital output DO1. The default for this setpoint is 100°F. To change the Cooling Night Setback setpoint scroll through the SETPOINTS menu tree, locate the Cooling Night Setback setpoint and enter a new temperature. The allowable temperature range is 75°F - 125°F.

Auxiliary Unit Enable. The Auxiliary Unit Enable function overrides all other Auto Mode functions and automatically cycles the unit into operation. This



Unit Operating Modes

function is activated whenever a contact is closed between the appropriate terminals on the unit's terminal strip located in the unit's main control panel. Heating and cooling functions use the Night Setback Setpoints. See the Typical Wiring Schematic and Multiplexed Input sections of this manual for more information. This function can be used with a twist timer, toggle switch, door switch, exhaust fan interlock, or any other dry contact to override the time clock schedule.

Heating/Ventilating/Cooling Operating Modes

The AdaptAire DDC controller automatically switches between the heating, ventilating and cooling modes of operation.

Heating Mode

Heating Mode allows the burner to operate as needed and is activated whenever the room temperature is 2° below the heating setpoint.

General Burner Control

In the Heating Mode the burner will modulate to maintain a constant temperature. To change the desired heating discharge or room temperature of an MDT or MRT control system, rotate the temperature setpoint knob on the remote panel clockwise to the desired temperature.

To change the desired heating room temperature of an MRT-Pro control system, depress the Warmer button to increase the desired room temperature setpoint or depress the Cooler button to decrease the desired room temperature setpoint. Each push of a button changes the temperature setpoint by 1°F. The setpoint can be changed a maximum of ±10°F from the default of 72°F.

To change the desired heating room temperature of an MRT-Expert control system, scroll through the SETPOINTS menu tree using the BACview, locate the Occupied Heating Setpoint, and enter a new temperature. The allowable temperature range is 55°F - 90°F. The burner will modulate using a PID loop to maintain this temperature.

Additionally, on all controls systems except the MDT the control system modulates the burner to maintain the supply air temperature within a defined operating window. This window defines the maximum and minimum discharge temperatures.

To change the desired minimum supply or discharge air temperature scroll through the SETPOINTS menu tree, locate the HTG MIN DA Setpoint, and enter a new temperature. This temperature must not be greater than the HTG MAX DA Setpoint. The allowable temperature range is 40°F - 130°F. This sets the lowest discharge air temperature that will leave the unit.

To change the desired maximum supply or discharge air temperature scroll through the SETPOINTS menu tree, locate the HTG MAX DA Setpoint, and enter a new temperature. This temperature must not be less than the HTG MIN DA



Unit Operating Modes

Setpoint. The allowable temperature range is 55°F - 130°F. This sets the highest discharge air temperature that will leave the unit.

If the maximum and minimum discharge temperature setpoints are set for the same temperature, the supply air temperature will be the same as the setpoint regardless of the room temperature setpoint or actual room temperature.

Recirculating Direct-Fired Heaters. Using different controller software, the AdaptAire DDC system can accommodate three distinct types of recirculating direct-fired units: those that return air before the burner and employ a special airflow station, those that return air before the burner and do not employ a special airflow station, and those that recirculate air after the burner. Recirculating direct-fired units, like all direct-fired units, deliver all of their products of combustion directly to the heated air space. For this reason it is extremely important that the proper ventilation rate be maintained to dilute these emissions.

AdaptAire units, that recirculate air before the burner and employ an airflow measuring station, utilize a control scheme that measures air pressure to determine the ratio of outside air and return air. These units are listed by an independent third party testing agency and use the equivalent temperature rise control scheme to limit burner modulation. The AdaptAire system accurately measures the ratio of outside and return air, calculates the allowable equivalent temperature rise and automatically limits the burners firing rate. This insures the products of combustion, delivered to the space by the unit, are held at or below allowable OSHA thresholds. The outside air percentage is the driving parameter for this function. A greater percentage of outside air or dilution air enables the unit to generate a higher allowable equivalent temperature rise.

AdaptAire units that recirculate air before the burner and do not employ an airflow measuring station utilize a control scheme that measures damper position to determine the percentage of return air. These units are not listed by an independent third party testing agency but do use the equivalent temperature rise control scheme to limit burner modulation.

AdaptAire units that recirculate air after the burner are physically constrained to limit the percentage of return air. These constraints are meant to provide the proper dilution air. An independent third party testing agency and do not use the equivalent temperature rise control scheme to limit burner modulation does not list these units.

In order of lowest to greatest priority the burner modulation parameters are: room temperature, discharge or supply air temperature, and equivalent temperature rise.

There are three Energy Savings modes that could disable the burner.

Energy Savings Mode 1—Mixing Box Recirculating Units. Energy Savings Mode 1 will automatically disable the burner if the mixed air temperature is equal to or greater than the minimum discharge air temperature setpoint, and the room air temperature is 5°F above the room air temperature setpoint. This function is intended to restrain the room temperature from rising uncontrollably in buildings



Unit Operating Modes

with internal heat gain. In certain conditions it may be necessary to readjust the minimum discharge air or room temperature setpoint upward or adjust the outside/return air ratio to provide a warmer supply air temperature.

Energy Savings Mode 1—Non-Recirculating Units. Energy Savings Mode 1 will automatically disable the burner if the outside air temperature is equal to or greater than the minimum discharge air temperature setpoint, and the room air temperature is 5°F above the room air temperature setpoint. This function is intended to restrain the room temperature from rising uncontrollably in buildings with internal heat gain. In certain conditions it may be necessary to readjust the minimum discharge air or room temperature setpoint upward or adjust the outside/return air ratio to provide a warmer supply air temperature.

Energy Savings Mode 2—Mixing Box Recirculating Direct-Fired Units. Energy Savings Mode 2 will automatically disable the burner if the burner's minimum firing rate exceeds the allowable equivalent temperature rise. This condition is unlikely to occur unless the burner's minimum firing rate is misadjusted and set too high, or the inlet air opening is restricted.

Energy Savings Mode 3. Energy Savings Mode 3 will automatically disable the burner if the outside air temperature is above the Outside Air Economizer setpoint. This function is similar to an inlet duct thermostat. The burner will cycle back on if the supply air temperature drops 3°F below the Outside Air Economizer setpoint.

To change the desired outside air economizer temperature scroll through the SETPOINTS menu tree, locate the ECONOMIZER Setpoint, and enter a new temperature. The default for this setpoint is 65°F. The allowable temperature range is 40°F - 80°F.

Ventilation Mode

Ventilation Mode occurs when the fan is running but the unit is not providing heating or cooling.

On an MDT control system the heating mode is activated when the remote temperature setpoint knob is turned to start the unit. See Energy Savings Modes for more information.

On all other systems the ventilation mode is dependant on the room temperature. The heating/ventilation/cooling operation is demonstrated below. The dotted line in the middle of the diagram represents the change between room temperature rise and room temperature fall. Select a point on the heavy line in the diagram to determine the mode of operation.

EXAMPLE: Start at point "A". The unit is in the ventilation mode and the room temperature is rising. Follow the dashed line upward. If the room temperature rises to a temperature that is 2°F over the cooling setpoint, the cooling will be enabled, and the unit will be in the cooling mode. Follow the solid line clockwise. Once the room temperature has fallen to the cooling setpoint, the cooling mode will be disabled, and the room will be in the ventilation mode. Follow the dashed

line downward. If the room temperature falls to a temperature that is 2°F below the heating setpoint, the heating will be enabled, and the unit will be in the heating mode. Continue following the solid line in a clockwise direction to the heating setpoint. Once the room temperature rises to the heating setpoint, the heating mode will be disabled, and the room will be in the ventilation mode.

Figure 1. Cooling Mode

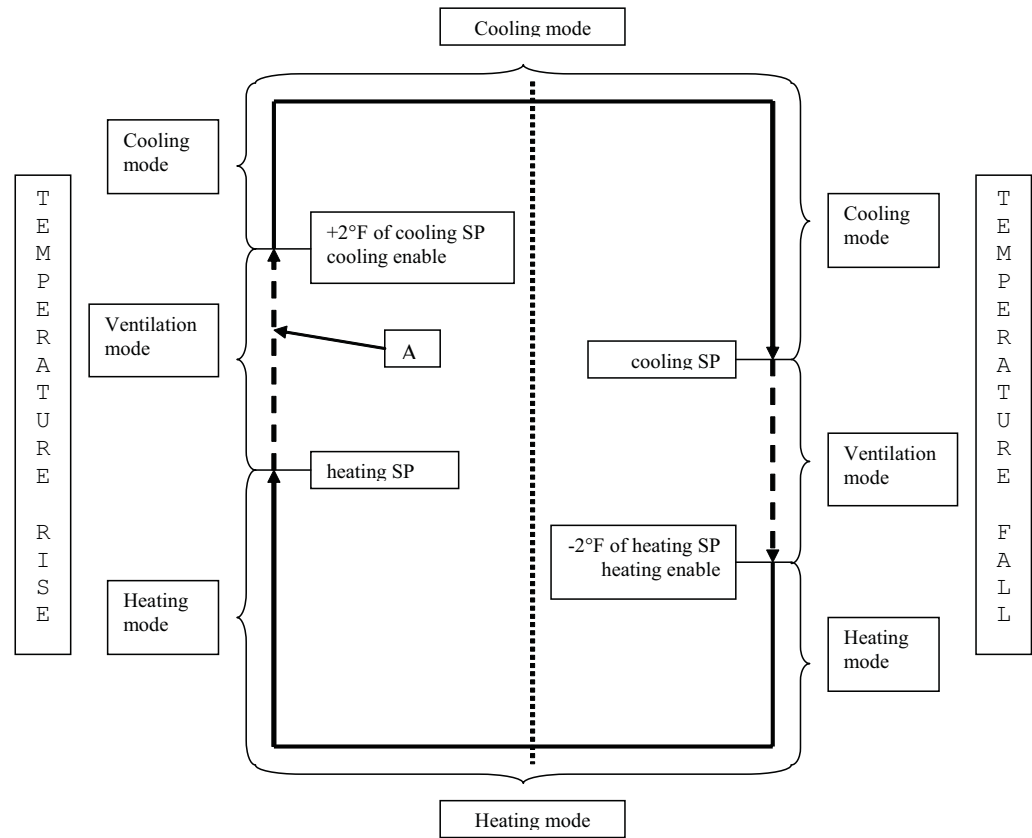

Cooling Mode

Cooling Mode allows the cooling to operate as needed and is activated whenever the room temperature is 2° above the cooling setpoint. In the Cooling Mode the cooling output will cycle to maintain a constant room temperature. The cooling output does not have an anti-cycle delay.

The MDT control system does not support the Cooling Mode.

To change the desired cooling room temperature of an MRT control system, rotate the temperature setpoint knob on the remote panel clockwise to the desired temperature. The allowable temperature range is 55°F - 90°F. The cooling will be disabled when the room temperature drops to the Cooling Setpoint.



Unit Operating Modes

To change the desired cooling room temperature of an MRT-Pro control system, depress the Warmer button to increase the desired room temperature setpoint or depress the Cooler button to decrease the desired room temperature setpoint. Each push of a button changes the temperature setpoint by 1°F. The setpoint can be changed a maximum of ±10°F from the default of 72°F.

To change the desired cooling room temperature of an MRT-Expert control system, scroll through the SETPOINTS menu tree using the BACview, locate the Occupied Cooling Setpoint, and enter a new temperature. The allowable temperature range is 61°F - 96°F. The burner will modulate using a PID loop to maintain this temperature.

Additionally, on all controls systems except the MDT the control system cycles the cooling output to maintain the supply air temperature within a defined operating window. This window defines the maximum and minimum discharge temperatures.

To change the desired minimum supply or discharge air temperature scroll through the SETPOINTS menu tree, locate the CLG MIN DA Setpoint, and enter a new temperature. This temperature must not be greater than the CLG MAX DA Setpoint. The allowable temperature range is 55°F - 130°F. This sets the lowest discharge air temperature that will leave the unit.

To change the desired maximum supply or discharge air temperature scroll through the SETPOINTS menu tree, locate the CLG MAX DA Setpoint, and enter a new temperature. This temperature must not be less than the CLG MIN DA Setpoint. The allowable temperature range is 55°F - 130°F. This sets the highest discharge air temperature that will leave the unit.

If the maximum and minimum discharge temperature setpoints are set for the same temperature, the supply air temperature will be the same as the setpoint regardless of the room temperature setpoint or actual room temperature.

Damper Control Modes

There are four different modes that control the unit damper operation: Manual, Mixed Air Temperature, Building Pressure, and 100% Outside Air. Except for the 100% Outside Air mode, these operating modes are selected through the menu tree of the local user interface or PC. Not all damper modes are available on all units.

Manual Mode

Manual Mode is the default damper operational mode. This will set the outside air damper to a fixed position.

MDT and MRT Controls. To place the damper operation in Manual Mode on an MDT or MRT control system be sure the appropriate terminals in the unit control panel are not shorted. See the Typical Wiring Schematic and Multiplexed Input sections of this manual for more information. Rotate the damper control knob on the remote panel to the desired percentage of outside air. If the unit served by this control is a direct-fired heater, that recirculates air before the burner, and is



Unit Operating Modes

operating in the heating mode, the unit will automatically keep the minimum outside air at 20%. If the outside air drops below 20%, the burner will cycle off. See Minimum Ventilation.

MRT-Pro Controls. To change the damper mode on an MRT-Pro control system requires the use of a BACview or PC. See the section related to the MRT Expert for instructions on how to use the BACview for programming.

MRT-Expert Control. To place the damper operation in Manual Mode scroll through the menu tree, locate the Damper Mode branch and select Manual Pos. Next, scroll through the menu tree, locate the Setpoints branch, select Man Vent SP, and enter the desired damper position. The allowable range is 0% to 100%. If the unit served by this control is a direct-fired heater, that recirculates air before the burner, and is operating in the heating mode, the unit will automatically keep the minimum outside air at 20%. If the outside air drops below 20%, the burner will cycle off. See Minimum Ventilation.

Mixed Air Temperature Mode

The Mixed Air Temperature mode varies the percentages of outside air and return air to maintain a constant mixed air temperature. The AdaptAire controller computes the mixed air temperature using the outside air and return air temperatures and the ratio of their respective airflows.

MDT and MRT Controls. To place the damper operation in Mixed Air Temperature Mode on an MDT or MRT control system be sure the appropriate terminals in the unit control panel are shorted. See the Typical Wiring Schematic and Multiplexed Input sections of this manual for more information. Rotate the damper control knob on the remote panel to the desired mixed air temperature. If the unit served by this control is a direct-fired heater, that recirculates air before the burner, and is operating in the heating mode, the unit will automatically keep the minimum outside air at 20%. If the outside air drops below 20%, the burner will cycle off. See Minimum Ventilation.

MRT-Pro Controls. To change the damper mode on an MRT-Pro control system requires the use of a BACview or PC. See the section related to the MRT Expert for instructions on how to use the BACview for programming.

MRT-Expert Control. To place the damper operation in Mixed Air Temperature Mode scroll through the menu tree, locate the Damper Mode branch and select MA Temp Ctrl. Next, scroll through the menu tree, locate the Setpoints branch, select Mixed Air, and enter the desired temperature. The allowable range is 30°F - 80°F. If the unit served by this control is a direct-fired heater, that recirculates air before the burner, and is operating in the heating mode, the unit will automatically keep the minimum outside air at 20%. If the outside air drops below 20%, the burner will cycle off. See Minimum Ventilation.



Unit Operating Modes

Building Pressure Mode

The Building Pressure mode varies the percentages of outside air and return air to maintain a constant pressure within the space. A pressure transducer compares the pressure outside the space to the pressure inside the space and transmits a corresponding signal to the AdaptAire controller. The controller compares this signal to the desired building pressure setpoint and uses a PID loop to modulate the outside air and return air dampers to maintain the specified building pressure.

MDT and MRT Controls. The MDT and MRT control systems do not support building pressure control mode.

MRT-Pro Controls. To change the damper mode on an MRT-Pro control system requires the use of a BACview or PC. See the section related to the MRT Expert for instructions on how to use the BACview for programming.

MRT-Expert Control. To place the damper operation in Building Pressure Mode scroll through the menu tree, locate the Damper Mode branch and select Bldg Prs Ctrl. Next, scroll through the menu tree, locate the Setpoints branch, select Bldg Prs, and enter the desired pressure. The allowable range is $-0.05''\text{wc}$ to $+0.05''\text{wc}$. If the unit served by this control is a direct-fired heater, that recirculates air before the burner, and is operating in the heating mode, the unit will automatically keep the minimum outside air at 20%. If the outside air drops below 20%, the burner will cycle off. See Minimum Ventilation.



Functions

100% Outside Air

The 100% Outside Air function automatically opens the outside air dampers and closes the return air dampers. This function is activated whenever a contact is closed between the appropriate terminals on the unit's terminal strip located in the unit's main control panel. See the Typical Wiring Schematic and Multiplexed Input sections of this manual for more information. The 100% Outside Air function overrides all other damper control functions. See User Configured PID Control for use with non-recirculating units.

Minimum Ventilation

To change the Minimum Ventilation requires the use of a BACview or PC. The Minimum Ventilation function defines the minimum outside air percentage and automatically prevents the dampers from modulating below this point. This function can be used in heating or cooling mode. If the unit served by this control is a direct-fired heater, that recirculates air before the burner, and is operating in the heating mode, the unit will automatically keep the minimum outside air at 20%. If the outside air drops below 20%, the burner will cycle off. To specify the Minimum Ventilation scroll through the menu tree, locate the Setpoints branch and select Min Vent, and enter the desired outside air percentage. The allowable range is 0% - 100% outside air.

Freezestat

To change the Minimum Ventilation requires the use of a BACview or PC. The Freezestat function automatically cycles the unit off if the supply air temperature drops below the Freezestat setpoint for 3 continuous minutes. There is an initial 8-minute delay prior activation on recirculating units, and an initial 6-minute delay on non-recirculating units. The Freezestat function prevents the unit from starting. The default for this setpoint is 45°F. To change the Freezestat setpoint scroll through the menu tree, locate the Setpoints branch, select Freezestat SP, and enter a new temperature. The allowable temperature range is 35°F - 50°F.

Clogged Filter

An optional clogged filter switch is required for this function. The Clogged Filter function automatically notifies the user of a dirty filter condition. A Clogged Filter indication will appear on the remote panel or local user interface. This function is activated whenever a contact is closed between the appropriate terminals on the unit's terminal strip located in the unit's main control panel. See the Typical Wiring Schematic and Multiplexed Input sections of this manual for more information.

User Configured PID Control

This function is applicable to non-recirculating units only. The User Configured PID Control function allows the user to control an analog output based on a user defined analog input and setpoint. See the Typical Wiring and Unit Controller Specification sections of this manual for more information regarding the inputs and outputs. This function also allows the user to select the PID type (direct or reverse acting) and establish upper and lower control limits. Five keypad entries define the operational parameters. These parameters are: User Control Setpoint, Minimum User Setpoint, Maximum User Setpoint, Low Input Value, and High Input Value. The low and high input values describe the input transducer range. The control setpoint is the primary operational parameter while the minimum and maximum setpoints describe the extents of the desired operating range and provide secondary control as described below. The allowable range for all of these parameters is -9999.99 - +99999.99.

The analog input and output are polarity sensitive and can be configured for different types of inputs. See the Typical Wiring and Unit Controller Specification sections of this manual for more information regarding the inputs and outputs.

The analog input must be connected to IN-1. This input must be configured for either of two different types of input signals:

- 0-5Vdc: The output impedance must not exceed 10K Ω . The input impedance of the controller is 1M Ω . This input is polarity sensitive. Be sure the connections from the source are correctly polarized at the controller.
- Thermistor: Precon type 2 (10k ohm at 77°F) Input voltages should range between 0.489V and 3.825V. See the wiring diagrams for recirculating model units for typical connections of transducers.
- The IN-1 configuration jumpers on the controller must be set for the appropriate input signal.

A contact closure between the appropriate terminals on the unit's terminal strip located in the unit's main control panel will drive the output to 100%. See the Typical Wiring Schematic and Multiplexed Input sections of this manual for more information.

DIRECT ACTING

The controller output is modulated by a PID loop from 0% to 100% based on the User Control setpoint and the input signal. As the input signal increases the output voltage increases. Additionally, a secondary control acts to override the PID loop to scale the output as follows.

If the input variable equals the User Control setpoint, the output will be determined by the PID loop. In this situation the override has no effect on the output value.

If the input variable is above the User Control setpoint, the output could increase from 0% to 100% as the input variable increases from the User Control setpoint



Functions

to the Max User setpoint. In this situation the output value is the greater of the PID output or the override output.

If the input variable is below the User Control setpoint, the output could decrease from 100% to 0% as the input variable decreases from the User Control setpoint to the Min User setpoint. In this situation the output value is the lesser of the PID output or the override output. See the following example.

Assume the user wishes to control a chilled water valve using a temperature transducer. The control variable will be supply air temperature. As the supply air temperature increases, the chilled water valve should open to lower the temperature. The temperature transducer has a range of 50°F - 85°F. The user would like the supply air temperature to be 75°F but does not want it to drop below 70°F or go above 80°F. The parameters entered on the keypad display will be:

PID Select	Direct (as input increases output increases)
High Input Val	85°F
Low Input Val	50°F
User Ctrl SP	75°F
Max User SP	80°F
Min User SP	70°F

The temperature transducer senses the supply air temperature and sends a corresponding signal to the AdaptAire controller. The controller compares this signal to the desired user control setpoint (75°F) and uses the PID loop to modulate the output from 0-100% (0-10Vdc). The output is connected to the chilled water valve that opens or closes to maintain the specified supply air temperature.

If the supply air temperature is 75°F, the output from the controller will be determined by the PID control sequence, and the override will have no effect on the output.

If the supply air temperature is more than 75°F, the output from the controller will be determined by the PID control sequence or the override whichever is less.

If the supply air temperature is less than 75°F, the output from the controller will be determined by the PID control sequence or the override whichever is more.

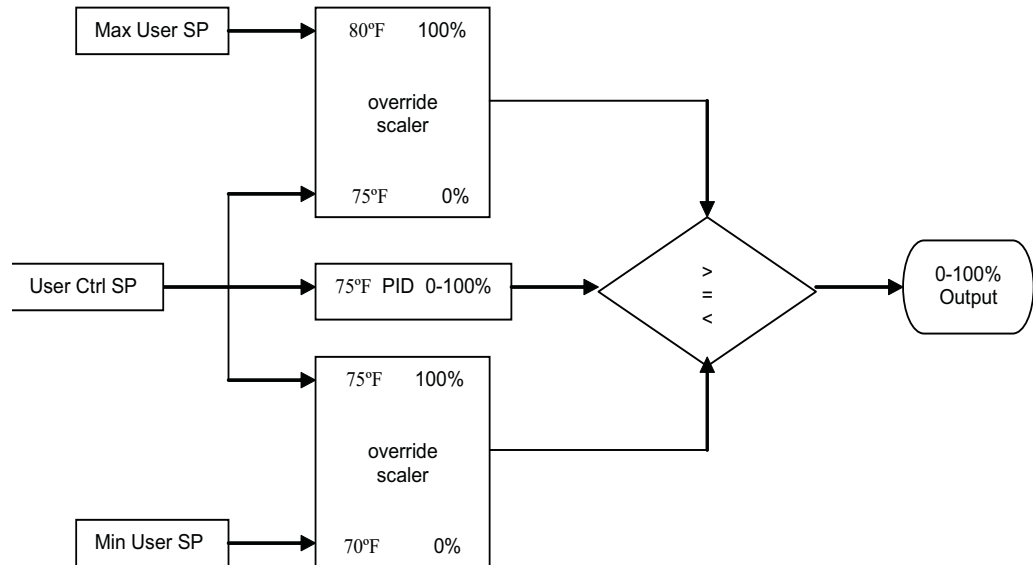
Figure 2. Direct acting

REVERSE ACTING

The controller output AO-1 is modulated by a PID loop from 0% to 100% based on the User Control setpoint and the input signal to IN-9. As the input signal increases the output voltage decreases. Additionally, a secondary control acts to override the PID loop to scale the output as follows.

If the input variable equals the User Control setpoint, the output will be determined by the PID loop. In this situation the override has no effect on the output value.

If the input variable is above the User Control setpoint, the output could decrease from 100% to 0% as the input variable increases from the User Control setpoint to the Max User setpoint. In this situation the output value is the lesser of the PID output or the override output.

If the input variable is below the User Control setpoint, the output could increase from 0% to 100% as the input variable decreases from the User Control setpoint to the Min User setpoint. In this situation the output value is the greater of the PID output or the override output. See the following example.

Assume the user wishes to control the fan speed using a variable frequency drive (VFD). The VFD input is 0-10Vdc. The control variable will be building pressure. As the building pressure increases, the fan speed should decrease. The building pressure transducer has a range of -0.1" to +0.1". The user would like the building

pressure to be +0.03" but does not want it to drop below 0.0" or go above +0.05". The parameters entered on the keypad display will be:

PID Select	Reverse (as input increases output decreases)
High Input Val	.10
Low Input Val	-0.10
User Ctrl SP	0.03
Max User SP	0.05
Min User SP	0.00

The pressure transducer compares the pressure outside the space to the pressure inside the space and transmits a corresponding signal to the AdaptAire controller. The controller compares this signal to the desired user control setpoint (0.03") and uses the PID loop to modulate the output from 0-100% (0-10Vdc). The output is connected to the VFD that changes speed to maintain the specified building pressure.

If the building pressure is 0.03", the output from the controller will be determined by the PID control sequence, and the override will have no effect on the output.

If the building pressure is more than 0.03", the output from the controller will be determined by the PID control sequence or the override whichever is less.

If the building pressure is less than 0.03", the output from the controller will be determined by the PID control sequence or the override whichever is more.

Figure 3. Reverse acting

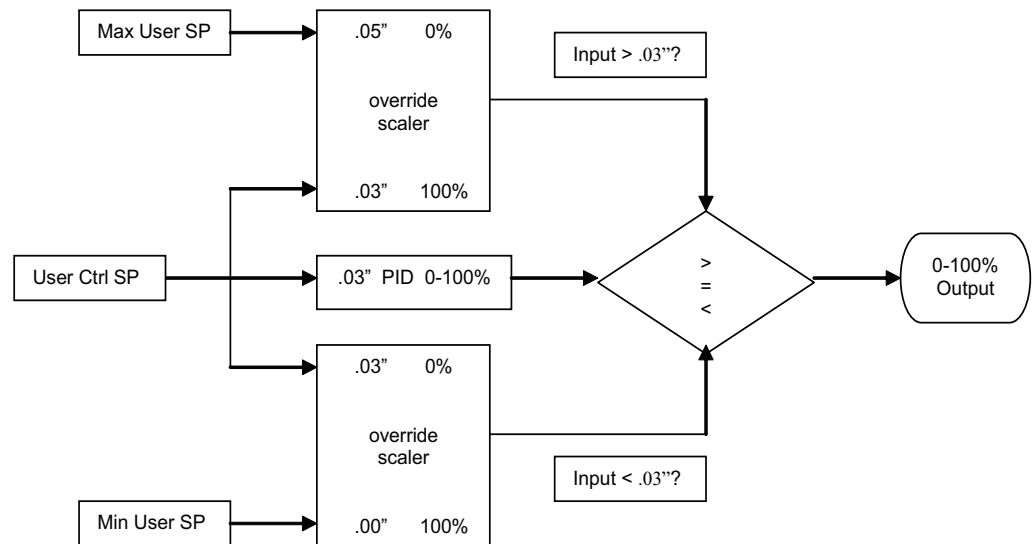

Unit Resets

This section should assist the user in resetting alarms and cycle counters which have been displayed on the BACview.

ALARM. To reset an alarm scroll through the menu tree, locate the Unit Resets branch and select Alarm. Press the Enter key. The word OFF should flash. Now press the INC key and the word ON should flash on the display. Press the Enter key again and ON should stop flashing. Repeat this process so the word OFF is displayed and not flashing. The alarm has now been cleared and the Alarm RS function has been rearmed.

CALIBRATE. The Calibrate function forces the controller to recalibrate the return air flow station. The recalibration will occur immediately if the fan is running or at the next fan start. To recalibrate scroll through the menu tree, locate the Unit Resets branch and select Calibrate. Press the Enter key. The word OFF should flash. Now press the INC key and the word ON should flash on the display. Press the Enter key again and ON should stop flashing. Repeat this process so the word OFF is displayed and not flashing. The calibration has now been initiated and the Calibration function has been rearmed.

FAN COUNT. Fan Count records each fan start. To reset a fan count scroll through the menu tree, locate the Unit Resets branch and select Fan Count. Press the Enter key. The word OFF should flash. Now press the INC key and the word ON should flash on the display. Press the Enter key again and ON should stop flashing. Repeat this process so the word OFF is displayed and not flashing. The fan count has now been cleared and the Fan Count function has been rearmed.

HEATING COUNT. Heating Count records each burner start. To reset a heating count scroll through the menu tree, locate the Unit Resets branch and select Heating Count. Press the Enter key. The word OFF should flash. Now press the INC key and the word ON should flash on the display. Press the Enter key again and ON should stop flashing. Repeat this process so the word OFF is displayed and not flashing. The heating count has now been cleared and the Heating Count function has been rearmed.

COOLING COUNT. Cooling Count records each cooling start. To reset a cooling count scroll through the menu tree, locate the Unit Resets branch and select Cooling Count. Press the Enter key. The word OFF should flash. Now press the INC key and the word ON should flash on the display. Press the Enter key again and ON should stop flashing. Repeat this process so the word OFF is displayed and not flashing. The cooling count has now been cleared and the Cooling Count function has been rearmed.

Multiplexed Inputs

DDC controllers are designed with a finite number of inputs and outputs. Multiplexing expands the functionality of the controller by allowing multiple devices to effectively share the same input. This is usually accomplished by connecting resistors, either in a series or parallel configuration, to an analog



Functions

input. A switch is used in conjunction with each resistor. When a switch is closed, the resistance at the controller input changes. This allows the controller to identify which switch has closed. The controller is programmed to associate each different resistance with a specific function. For example when the optional clogged filter switch is closed between the appropriate terminals on the unit's terminal strip located in the unit's main control panel, this tells the controller that the filters are clogged, and it notifies the user through the local user interface. See the Typical Wiring Schematic section of this manual for more information.

Clock Set

The Clock Set function is used to set the current time and date as well as enabling Daylight Saving Time. To set the clock scroll through the menu tree, locate the Clockset branch, select Date, and enter a new date and time. Select DST to enable Daylight Saving Time. Daylight Saving Time is the default. If the unit is installed in the southern hemisphere, Sou Hem must be enabled. The default is not Sou Hem. For your convenience Daylight Saving Time has been preprogrammed for the next several years. To reset the starting and ending DST dates scroll through the DST menu tree, locate the desired year, and enter a new date.



Diagnostics

Critical Fault Codes

This section should assist the user in troubleshooting critical fault codes messages that have been displayed on the local user interface. These faults require the operator to correct the condition and reset the alarm before normal unit operation resumes.

FAULT CODE: Low Discharge Temperature

PROBLEM: The controller has detected a low temperature at the fan outlet and has shut off the unit. See Freezestat section of this manual.

SOLUTION: If burner was operating prior to shutdown (check prior alarm log)

1. Is the outside air (OA Temp) or room air (Room Temp) displayed on the BACview remote, reading 150°F or more?
 - Yes. That sensor circuit or the sensor itself is shorted. Unplug the input jack from the AdaptAire controller. Did the display change to -40°F or less?
 - *No. There is a short in the controller input. Replace the controller.*
 - *Yes. Disconnect the sensor wiring at the sensor. Connect an ohmmeter to the sensor. If it is shorted replace the sensor. At 77°F the resistance should be 10K?. See thermistor output curve for other temperatures. If it is not shorted, there is a short in the wiring between the sensor and the input plug. Determine cause and rectify. Refer to Appendix II for a typical 10K? thermistor output curve.*
 - No. Continue.
2. Is the discharge air temperature (DA Temp), displayed on the BACview remote, reading -40°F or less?
 - Yes. That sensor circuit or the sensor itself is open. Jumper the input for the sensor. Did the display change to 150°F or more?
 - *No. There is an open in the controller input. Replace the controller.*
 - *Yes. Disconnect the sensor wiring at the sensor. Connect an ohmmeter to the sensor. If it is open replace the sensor. At 77°F the resistance should be 10K?. See thermistor output curve for other temperatures. If it is not open, there is a break in the wiring between the sensor and the input plug. Determine cause and rectify.*
 - No. Continue
3. Reset the alarm. Check and note the DC voltage at output for the gas valve modulation. Set the Heating Setpoint for 90°F. Set the MAX DAT and MIN DAT Setpoints for 130°F. Did the Burner VDC, displayed on the BACview remote, increase?
 - No. Unless the outside air temperature is extremely warm the Burner VDC should have increased to 7.5VDC or more. Close the manual main gas

- valve closest to the burner and measure the discharge air temperature. Is it less than 130°F?
- *Yes. There is a problem with the controller program or controller itself. Contact the factory.*
 - *No. The outside air temperature is too hot to determine the actual cause of the problem. Reset the alarm and recheck when the outside air temperature is much cooler.*
- Yes. This signal is fed to the gas valve modulation signal conditioner. Disconnect the wires from input signal terminals on the signal conditioner and measure the voltage on the wires. Is it the same as the voltage coming from the controller?
- *No. There is an open in the wiring from the controller output. Correct wiring and reconnect the wires to the terminals on the signal conditioner. Be sure the ground wire from the controller output terminal is connected to the signal conditioner's negative terminal.*
 - *Yes. Continue.*
4. Is there 24VAC on the signal conditioner power terminals?
- No. Determine cause and rectify.
 - Yes. Continue.
5. Is there twice the DC voltage on the signal conditioner's output terminals as there is on the signal conditioner's input terminals?
- No. Replace the signal conditioner.
 - Yes. Continue.
6. Is the DC voltage on the modulating valve terminals the same as the DC voltage on the signal conditioner's output terminals?
- No. There is a break in the wiring between the signal conditioner and the modulating valve terminals. Determine cause and rectify.
 - Yes. The electronics are working to this point. Continue.
7. Is there sufficient temperature rise for the amount of outside air that is being delivered to the space?
- No. Follow the instructions in this manual for placing the unit in Manual damper control mode. Adjust the Man. Vent setpoint to 20% outside air. Is there sufficient temperature rise for the amount of outside air that is being delivered to the space?
 - *No. Contact the factory.*
 - *Yes. Continue.*
 - Yes. Continue.
8. Verify there is sufficient inlet gas pressure. Verify the modulating valve is properly adjusted. Verify the burner orifices are clear of obstruction. Contact the factory.

SOLUTION: If burner was not operating prior to shutdown (check prior alarm log)

1. Is there a prior alarm such as Safety Ckt., Airflow Sw., or Flame Failure?
 - Yes. See the Diagnostic section for the previous alarm.
 - No. Continue.
2. Is the room air (Room Temp) displayed on the BACview remote, reading 150°F or more?
 - Yes. The sensor circuit or the sensor itself is shorted. Unplug the input jack from the AdaptAire controller. Did the display change to -40°F or less?
 - *No. There is a short in the controller input. Replace the controller.*
 - *Yes. Disconnect the sensor wiring at the sensor. Connect an ohmmeter to the sensor. If it is shorted replace the sensor. At 70°F the resistance should be 10K?. See thermistor output curve for other temperatures. If it is not shorted, there is a short in the wiring between the sensor and the input plug. Determine cause and rectify. Refer to Appendix II for a typical 10K? thermistor output curve.*
 - No. Continue.
3. Is the discharge air temperature (DA Temp), displayed on the BACview remote, reading -40°F or less?
 - Yes. The discharge air temperature sensor circuit or the sensor itself is open. Jumper the input for the sensor. Did the display change to 150°F or more?
 - *No. There is an open in the controller input. Replace the controller.*
 - *Yes. Disconnect the discharge air temperature sensor wiring at the sensor. Connect an ohmmeter to the sensor. If it is open replace the sensor. At 70°F the resistance should be 10K?. See thermistor output curve for other temperatures. If it is not open, there is a break in the wiring between the sensor and the input plug. Determine cause and rectify.*
 - No. Continue
4. Reset the alarm. Check and note the DC voltage at controller's analog output for the heating signal. Set the Heating Setpoint for 90°F. Set the HTG MAX DA and HTG MIN DA Setpoints for 130°F. Did the Burner VDC, displayed on the BACview remote, increase?
 - No. Unless the outside air temperature is extremely warm the Burner VDC should have increased to 7.5VDC or more. Close the manual main gas valve closest to the burner and measure the discharge air temperature. Is it less than 130°F?
 - *Yes. There is a problem with the controller program or controller itself. Contact the factory.*
 - *No. The outside air temperature is too hot to determine the actual cause of the problem. Reset the alarm and recheck when the outside air temperature is much cooler.*

- Yes. This signal is fed to the signal conditioner. Disconnect the wires from the signal conditioner's input signal terminals and measure the voltage on the wires. Is it the same as the voltage coming from the controller?
 - *No. There is an open in the wiring from the controller output. Correct wiring and reconnect the wires to the terminals on the signal conditioner. Be sure the wire from the controller's ground terminal is connected to the signal conditioner's ground terminal.*
 - *Yes. Continue.*
- 5. Is there 24VAC on the signal conditioner power terminals?
 - No. Determine cause and rectify.
 - Yes. Continue.
- 6. Is there twice the DC voltage on the signal conditioner's output terminals as there is on the signal conditioner's input terminals?
 - No. Replace the signal conditioner.
 - Yes. Continue.
- 7. Is the DC voltage on the modulating valve terminals the same as the DC voltage on the signal conditioner's output terminals?
 - No. There is a break in the wiring between the signal conditioner and the modulating valve terminals. Determine cause and rectify.
 - Yes. The electronics are working to this point. Continue.
- 8. Is there sufficient temperature rise for the amount of outside air that is being delivered to the space?
 - No. Follow the instructions in this manual for placing the unit in Manual damper control mode. Adjust the Man. Vent setpoint to 20% outside air. Is there sufficient temperature rise for the amount of outside air that is being delivered to the space?
 - *No. Contact the factory.*
 - *Yes. Continue.*
 - Yes. Continue.
- 9. Verify there is sufficient inlet gas pressure. Verify the modulating valve is properly adjusted. Verify the burner orifices are clear of obstruction. Contact the factory.

FAULT CODE: Safety Circuit Open

PROBLEM:The controller has detected a failure in the safety circuit.

SOLUTION: If fan is not running (check prior alarm log)

1. Is there a prior alarm such as Unit On/Fan Off or Airflow Sw?
 - Yes. See the Diagnostic section for the previous alarm.
 - No. Continue.
2. Set Unit Mode to Manual. Did fan start?

- No. See the Diagnostic section for Unit On/Fan Off.
- Yes. Continue.

SOLUTION:If fan is running (check prior alarm log)

1. Is the high temperature limit tripped?
 - Yes. Determine cause and rectify.
 - No. Continue.
2. Is the low gas pressure switch closed?
 - No. Verify the inlet gas pressure is as specified on the gas piping diagram. The low gas pressure switch setpoint should not be adjusted. The inlet gas pressure must remain as specified when unit fires at full input. Correct gas pressure and reset switch. If the switch cannot be reset, replace it. See Installation, Operation and Owners Manual for more information.
 - Yes. Continue.
3. Is the high gas pressure switch closed?
 - No. Verify the firing rate pressure at full input is as specified on the unit rating plate. The high gas pressure switch setpoint should not be adjusted. The firing rate pressure must remain as specified when unit fires at full input. Correct gas pressure and reset switch. If the switch cannot be reset, replace it. See Installation, Operation and Maintenance Manual for more information.
 - Yes. Continue.
4. Is the safety circuit relay energized?
 - No. Check for loose wiring and rectify.
 - Yes. Continue.
5. Is the safety circuit relay's normally open contact closed?
 - No. Replace the relay.
 - Yes. Continue.
6. Is there continuity at the controller between the safety status terminals?
 - No. There is an open in the wiring between these terminals. Determine cause and rectify.
 - Yes. Replace controller.

FAULT CODE:Burner Status

PROBLEM: The controller has activated the burner enable output, but the burner status input is not receiving a signal that the burner is on.

SOLUTION:Inspect burner control circuit and burner

1. Is there a prior alarm such as Unit On/Fan Off, Airflow Sw., or Safety Circuit?
 - Yes. See the Diagnostic section for the previous alarm.

- No. Continue.
- 2. Is the burner enable relay energized?
 - No. There is an open in the 24VAC circuit. Determine cause and rectify.
 - Yes. Continue.
- 3. Is the burner enable relay's normally open contact closed?
 - No. Replace relay.
 - Yes. Continue.
- 4. Is there a pilot flame present?
 - No. Refer to the Installation, Operation and Maintenance Manual for guidance in troubleshooting the flame relay or ignition module.
 - Yes. Continue.
- 5. Is the flame relay or ignition module main valve terminal energized?
 - No. Refer to the Installation, Operation and Maintenance Manual for guidance in troubleshooting the flame relay or ignition module.
 - Yes. Continue.
- 6. Is the gas valve/burner status relay energized?
 - No. There is an open in the main valve control circuit. Determine cause and rectify.
 - Yes. Continue.
- 7. Is the gas valve/burner status relay's normally open contact closed?
 - No. Replace relay.
 - Yes. Continue.
- 8. Is there continuity at the controller between the burner status terminals?
 - No. There is an open in the wiring between these terminals. Determine cause and rectify.
 - Yes. Replace controller.

FAULT CODE: Burner Hand

PROBLEM: The controller has not activated the burner enable output, but the burner status input is receiving a signal that the burner is on.

SOLUTION: Inspect burner control circuit. This fault has the potential to be a very serious problem. Close the manual gas valves immediately if the fan is not running.

1. Is the controller's burner enable output LED lit?
 - Yes. Close manual gas valves. There is a problem with the controller program. Contact factory.
 - No. Continue.

2. Are the main automatic gas shutoff valves energized?
 - No. The main automatic gas shutoff valves are leaking. Turn off unit and close manual gas valves. Determine cause of valve failure and rectify.
 - Yes. Continue.
3. Is the flame relay energized?
 - No. There is a short in the wiring of the gas valves. Close manual gas valves. Determine cause of short and rectify.
 - Yes. Continue.
4. Is the burner enable relay energized?
 - Yes. There is a short in the wiring of the flame relay. Close manual gas valves. Determine cause of short and rectify.
 - No. Continue.
5. Is the burner enable relay's normally open contact closed?
 - Yes. Close manual gas valves. Replace the relay.
 - No. Continue.
6. Unplug the input terminals from the input jack. Is there continuity at the controller between the burner status terminals?
 - No. Close manual gas valves. There is a short in the wiring between the burner status relay and the burner status terminals. Determine cause and rectify.
 - Yes. Close manual gas valves. Replace the controller.

FAULT CODE: Flame Failure

Note: This fault code is not applicable to all unit types.

PROBLEM:The controller has received a signal from the flame relay indicating a flame failure.

SOLUTION:Investigate flame relay

1. Is there a prior alarm such as Unit On/Fan Off, Airflow Sw., or Safety Circuit?
 - Yes. See the Diagnostic section for the previous alarm.
 - No. Continue.
2. See flame relay troubleshooting information in unit Installation, Operation, and Maintenance Manual.

Diagnostics - Non-Critical Fault Codes

This section should assist the user in troubleshooting non-critical fault code messages that have been displayed on the local user interface. Most of these faults are automatically reset once the fault is corrected or condition changes.

FAULT CODE: Unit off/Fan on

PROBLEM: The controller has not activated the unit enable output to start the fan, but the fan status input, is receiving a signal that the fan is running. This fault will automatically clear about 15 seconds after the fault is corrected.

SOLUTION: If fan is running

1. Is controller unit enable output LED for lit?
 - Yes. There is a problem with the controller program. Call factory.
 - No. Continue.
2. Is controller output contact for the unit enable output closed?
 - Yes. Turn off the power to the controller and recheck. If contact is still closed the controller output is shorted. Replace the controller.
 - No. Continue.
3. Is the unit enable relay energized?
 - Yes. There is a short or jumper in the wiring. Determine cause and rectify.
 - No. Continue.
4. Is motor starter energized?
 - Yes. There is a short or jumper in the wiring. Determine cause and rectify.
 - No. Continue.
5. Is the fan status relay energized?
 - Yes. There is a short or jumper in the wiring. Determine cause and rectify.
 - No. Continue.
6. Is the fan status relay's normally open contact, closed?
 - Yes. Replace relay.
 - No. Continue.
7. Is there continuity between at the controller between the fan status terminals?
 - Yes. There is a short in the wiring between these terminals. Determine cause and rectify.
 - No. Replace controller.

SOLUTION: If fan is not running

1. Is the fan status relay's normally open contact, closed?
 - Yes. Replace relay.
 - No. Continue.
2. Is there approximately 5VDC at both controller terminals used for the fan status?

- Yes. There is a short in the wiring between these terminals. Determine cause and rectify.
- No. Replace controller.

FAULT CODE:Unit on/Fan off

PROBLEM:The controller has activated the unit enable output to start the fan, but the fan status input, is not receiving a signal that the fan is running. This fault will automatically clear about 60 seconds after the fault is corrected. Turning the unit off and then on will clear this fault at any time.

SOLUTION:If fan/motor is running

1. Is the BACview remote indicating an alarm?
 - Yes. Check previous alarms and continue.
 - bContinue.
2. Is the motor starter's normally open auxiliary contact, closed?
 - No. Replace contact.
 - Yes. Continue.
3. Are the high and low velocity airflow switch contacts, closed?
 - No. Are the belts on and is the fan motor.
 - *Yes. Contact factory. Do not adjust the switches setpoints.*
 - *No. Determine cause and rectify.*
 - Yes. Continue.
4. Is the fan status relay energized?
 - No. There is an open or break in the wiring. Determine cause and rectify.
 - Yes. Continue.
5. Is the fan status relay's normally open auxiliary contact, closed?
 - No. Replace relay.
 - Yes. Continue.
6. Is there continuity at the controller between the fan status terminals?
 - No. There is an open in the wiring between these terminals. Determine cause and rectify.
 - Yes. Replace controller.

SOLUTION: If fan/motor is not running

1. Is the BACview remote indicating an alarm?
 - Yes. Check previous alarms and continue.
 - No. Continue.
2. Is controller output LED for the unit enable output lit?
 - No. There is a problem with the controller. Replace controller.

- Yes. Continue.
- 3. Is the unit enable relay energized?
 - No. There is an open in the wiring between these terminals. Determine cause and rectify.
 - Yes. Continue.
- 4. Is the unit enable relay's normally open contact, closed?
 - No. Replace relay.
 - Yes. Continue.
- 5. Is the motor overload relay tripped?
 - Yes. Determine cause, rectify and reset.
 - No. Continue.
- 6. Is the motor starter energized?
 - No. There is an open or break in the wiring. Determine cause and rectify.
 - Yes. Check motor and motor wiring.

FAULT CODE: Check Airflow Switches

PROBLEM: The controller has activated the unit enable output to start the fan, and detected that the fan is running from a signal at the fan status input. Subsequently, the controller has detected a momentary opening of the fan status input. The momentary opening must occur within two seconds of the previous closure for this fault to occur. This fault requires the operator to correct the condition and reset the alarm before normal unit operation resumes.

SOLUTION: If high airflow switch is opening. Do not adjust the switch setpoints

1. Are all of the filters in place?
 - No. Install filters and continue.
 - Yes. Continue.
2. Does the external static pressure match that listed on the rating plate?
 - No. Verify all associated ductwork is installed and continue.
 - Yes. Continue.
3. Does the fan RPM match that listed on the Spec. Sheet?
 - No. Correct to reduced fan speed and continue.
 - Yes. Continue.
4. Are the airflow switches' sensing tubes obstructed?
 - Yes. Clear and continue.
 - No. Continue.
5. Contact factory.

SOLUTION:If low airflow switch is opening. Do not adjust the switch setpoints

1. Does low airflow switch open when the burner is off
 - No. Disconnect both pressure sensing tubes from one of the airflow switches and measure the differential pressure by connecting the high sensing port of a manometer to one of the airflow sensing tubes and the low sensing port to the other. Is the differential pressure approximately the midpoint between the high and low airflow switch setpoints?
 - *No. Close the profile opening until the differential pressure is approximately the midpoint between the high and low airflow switch setpoints. Reconnect the sensing tubes, restart the burner, and verify the airflow switch remains closed when the burner is at the maximum rated input. Continue.*
 - *Yes. Continue.*
2. Are all of the filters dirty?
 - Yes. Install clean filters and continue.
 - No. Continue.
3. Does the external static pressure match that listed on the rating plate?
 - No. Verify all associated ductwork is installed as designed, and there are no obstructions. Continue.
 - Yes. Continue.
4. Does the fan RPM match that listed on the Spec. Sheet?
 - No. Correct to increased fan speed and continue.
 - Yes. Continue.
5. Are the airflow switches' sensing tubes obstructed?
 - Yes. Clear and continue.
 - No. Continue.
6. Contact factory.

FAULT CODE: Clogged Filter Switch

PROBLEM: The filter air pressure switch has closed between the appropriate terminals on the unit's terminal strip located in the unit's main control panel indicating a clogged filter. See the Typical Wiring Schematic, Multiplexed Input, and Clogged Filter sections of this manual for more information.

SOLUTION:If clogged filter switch is closing.

1. Are the filters dirty?
 - Yes. Install clean filters and continue.
 - No. Continue.
2. Are the airflow switch sensing tubes obstructed?

- Yes. Clear and continue.
 - No. Continue.
3. Is the airflow switch setpoint properly adjusted?
 - No. Adjust setpoint.
 - Yes. Continue.
 4. Are the wires connected to the air pressure switch's normally open contact?
 - No. Rewire switch and continue.
 - Yes. Continue.
 5. Is the air pressure switch's normally open contact open?
 - No. Disconnect the sensing tubes and recheck. Replace the switch if contacts do not open.
 - Yes. Continue.
 6. Find the clogged filter switch on the electrical schematic and identify the control panel terminals to which it is connected. Disconnect the wire from these terminals. Does this clear the alarm?
 - Yes. There is short in the wiring between the terminal strip and the switch. Determine cause and rectify.
 - No. Continue.
 7. Unplug the connector from the controller that is connected to the multiplexed input. Does this clear the alarm?
 - Yes. There is short in the wiring of the multiplexed resistors. Determine cause and rectify.
 - No. There is an internal short in the controller. Replace the controller.

FAULT CODE:Energy Save Mode 1

PROBLEM: The controller has turned off the burner enable output because it determined the mixed air temperature is equal to or greater than the minimum discharge air temperature setpoint, and the room air temperature is 5°F above the room air temperature setpoint. See the Energy Savings Mode 1 section of this manual for more information.

SOLUTION:If setpoints are misadjusted

1. Is the mixed air temperature (MA Temp), displayed on the BACview remote, greater than or equal to the minimum discharge air temperature setpoint?
 - Yes. Increase the HTG MIN DAT setpoint. See Heating Mode - General Burner Control section of this manual for more information.
 - No. Continue.
2. Is the room temperature more than 5°F above the room air temperature setpoint?
 - Yes. Increase the HTG OCCUPIED setpoint. See Heating Mode - General Burner Control section of this manual for more information.

- No. Continue.

SOLUTION: If setpoints are not misadjusted

1. Is there a prior alarm such as Insufficient OA?
 - Yes. See the Diagnostic section for the previous alarm.
 - No. Continue.
2. Is the discharge air temperature (DA Temp), displayed on the BACview remote, reading 150°F or more?
 - Yes. That sensor circuit or the sensor itself is shorted. Unplug the input jack from the AdaptAire controller. Did the display change to -40°F or less?
 - *No. There is a short in the controller input. Replace the controller.*
 - *Yes. Disconnect the sensor wiring at the sensor. Connect an ohmmeter to the sensor. If it is shorted replace the sensor. At 70°F the resistance should be 10K?. See thermistor output curve for other temperatures. If it is not shorted, there is a short in the wiring between the sensor and the input plug. Determine cause and rectify. Refer to Appendix II for a typical 10K? thermistor output curve.*
 - No. Contact factory.

FAULT CODE: Energy Save Mode 2

PROBLEM: The controller has turned off the burner enable output because it determined the burner's minimum firing rate exceeds the allowable equivalent temperature rise. See the Energy Savings Mode 2 section of this manual for more information.

SOLUTION: If OAT, RoomT or DAT are such that heat is required

1. Are the outside air hood filters or bird screen or any associated outside air ductwork obstructed?
 - Yes. Clear obstruction or change filters.
 - No. Continue.
2. Are the outside air and return air dampers and actuators working properly?
 - Yes. Continue.
 - No. Make necessary adjustments and force the unit to recalibrate. See Calibrate in the Resets Section of this manual.
3. If equipped, are the flow measuring station pitot tubes and pressure tubing clear?
 - Yes. Continue.
 - No. Clean and force the unit to recalibrate. See Calibrate in the Resets Section of this manual.
4. Do the dampers track with a change in the %OA setpoint? The dampers utilized on the unit are not linear with respect to airflow and openness, and as such, the proportion of outside air to damper movement will not be exactly

equal to the %OA setpoint. However, at 20% OA the dampers should be at least ½" open.

- Yes. Continue.
 - No. Check the damper motor and linkage connections. When 24VAC is powering the damper actuator and the control signal is 0VDC, the outside air damper should be close to a "rattle tight" position and the return air damper should be open. If the 24VAC power is removed, the actuator will draw the outside air damper tightly closed and the return air damper tightly open. When 24VAC is powering the damper actuator and the control signal is 10VDC, the outside air damper should be fully open and the return air damper should be closed.
5. Is there approximately 24VAC at the COM and EXC terminals on the airflow station pressure transducer?
- Yes. Continue.
 - No. Is there 120VAC on the primary side of the low voltage transformer and 24VAC volt at the transformer secondary?
 - *Yes. There is an open in the wiring between the transformer and the transducer. Locate the wiring problem and rectify.*
 - *No. If there is 120VAC on the primary and 0VAC on the secondary, replace the transformer. If there is 0VAC on the primary, there is an open in the wiring supplying power to the transformer. Locate the wiring problem and rectify.*
6. Remove both of the plastic tubes from the airflow station pressure transducer and gently blow into the HIGH side port. Caution: The transducer is extremely sensitive. Blowing too hard into the sensing tube may damage the transducer. Is there approximately 5VDC across the COM and OUT terminals of the pressure transducer?
- Yes. Continue.
 - No. The pressure transducer is defective. Replace it.
7. Remove both of the plastic tubes from the airflow station pressure transducer and gently blow into the HIGH side port. Caution: The transducer is extremely sensitive. Blowing too hard into the sensing tube may damage the transducer. Is there approximately 5VDC across the controller input terminals that are connected to the transducer?
- Yes. There is a problem with the controller. Replace it.
 - No. There is an open in the wiring between these pressure transducer and the AdaptAire controller terminals. Locate and rectify.

FAULT CODE:Energy Save Mode 3

PROBLEM: The controller has turned off the burner enable output because it determined the inlet air temperature exceeds the Economizer setpoint. See the Energy Savings Mode 3 section of this manual for more information.

SOLUTION: If OAT, RoomT or DAT are such that heat is required

1. Is the outside air temperature (OA Temp), displayed on the BACview remote, reading 150°F or more?
 - Yes. The outside air sensor circuit or the sensor itself is shorted. Unplug the input jack from the AdaptAire controller. Did the display change to -40°F or less?
 - *No. There is a short in the controller input. Replace the controller.*
 - *Yes. Disconnect the sensor wiring at the sensor. Connect an ohmmeter to the sensor. If it is shorted replace the sensor. At 70°F the resistance should be 10K?. See thermistor output curve for other temperatures. If it is not shorted, there is a short in the wiring between the sensor and the input plug. Determine cause and rectify. Refer to Appendix II for a typical 10K? thermistor output curve.*
2. Is the outside air sensor in the direct sunlight?
 - Yes. Provide shade for the sensor so the direct sun does not affect it.
 - No. Contact factory.

SOLUTION: If setpoints are misadjusted

1. Is the Econmzr Setpoint set for 80°F?
 - Yes. The outside air temperature is over 80°F and there should be no need for heat. If this is not the case, contact factory.
 - No. Increase the ECONMZR SP setpoint. See Heating Mode - Energy Savings Mode 3 section of this manual for more information.

FAULT CODE:Insufficient OA

PROBLEM: The controller has turned off the burner enable output because the percentage of outside air has dropped below 20% for more than five minutes, and the unit is in the Heating mode.

SOLUTION:If heat is desired

1. Are the outside air hood filters or bird screen or any associated outside air ductwork obstructed?
 - Yes. Clear obstruction or change filters.
 - No. Continue.
2. Are the outside air and return air dampers and actuators working properly?
 - Yes. Continue.
 - No. Make necessary adjustments and force the unit to recalibrate. See Calibrate in the Resets Section of this manual.
3. Are the flow measuring station pitot tubes and pressure tubing clear?
 - Yes. Continue.
 - No. Clean and force the unit to recalibrate. See Calibrate in the Resets Section of this manual.

4. Do the dampers track with a change in the %OA setpoint? The dampers utilized on the unit are not linear with respect to airflow and openness, and as such, the proportion of outside air damper movement will not be exactly equal to the %OA setpoint. However, at 20% OA the dampers should be approximately ½" open.
 - Yes. Continue.
 - No. Check the damper motor and linkage connections. When 24VAC is powering the damper actuator and the control signal is 0VDC, the outside air damper should be close to a "rattle tight" position and the return air damper should be open. If the 24VAC power is removed, the actuator will draw the outside air damper tightly closed and the return air damper tightly open. When 24VAC is powering the damper actuator and the control signal is 10VDC, the outside air damper should be fully open and the return air damper should be closed.
5. Is there approximately 24VAC at the COM and EXC terminals on the airflow station pressure transducer?
 - Yes. Continue.
 - No. Is there 120VAC on the primary side of the low voltage transformer and 24VAC volt at the transformer secondary?
 - *Yes. There is an open in the wiring between the transformer and the transducer. Locate the wiring problem and rectify.*
 - *No. If there is 120VAC on the primary and 0VAC on the secondary, replace the transformer. If there is 0VAC on the primary, there is an open in the wiring supplying power to the transformer. Locate the wiring problem and rectify.*
6. Remove both of the plastic tubes from the airflow station pressure transducer and gently blow into the HIGH side port. Caution: The transducer is extremely sensitive. Blowing too hard into the sensing tube may damage the transducer. Is there approximately 5VDC across the COM and OUT terminals of the pressure transducer?
 - Yes. Continue.
 - No. The pressure transducer is defective. Replace it.
7. Remove both of the plastic tubes from the airflow station pressure transducer and gently blow into the HIGH side port. Caution: The transducer is extremely sensitive. Blowing too hard into the sensing tube may damage the transducer. Is there approximately 5VDC across the controller input terminals that are connected to the transducer?
 - Yes. There is a problem with the controller. Replace it.
 - No. There is an open in the wiring between these pressure transducer and the AdaptAire controller terminals. Locate and rectify.

SOLUTION:If less outside air is desired

1. Is heat required?



Diagnostics

- Yes. The AdaptAire control system must be in the Heating mode. In this mode the smallest allowable amount of outside air is 20%. Verify the system is in the Heating mode and the MIN VENT SP is set for 20%. See Heating/Cooling Mode and Minimum Ventilation Sections of this manual.
 - No. Continue.
2. Is cooling or ventilation required?
- Yes. The AdaptAire control system must be in the Ventilation/Cooling mode. In this mode the smallest allowable amount of outside air is 0%. Verify the system is in the Cooling mode and the MIN VENT SP is set for the desired percent of outside air. See Heating/Ventilating/Cooling Mode and Minimum Ventilation Sections of this manual.
 - No. Contact factory.

Menu Selection

Menu Selection Tree for BACview

This section will assist the user in navigating the menu functions of the control program. For convenience Hotkeys are provided to allow the user to jump directly to a specific menu heading. Simply press and hold the FN key. While holding the FN key, press the number key of the desired menu, and it will appear. The number key associated with the menu heading is shown below. Links to other menu headings are also available by pressing one of the 4 keys located directly below the screen.

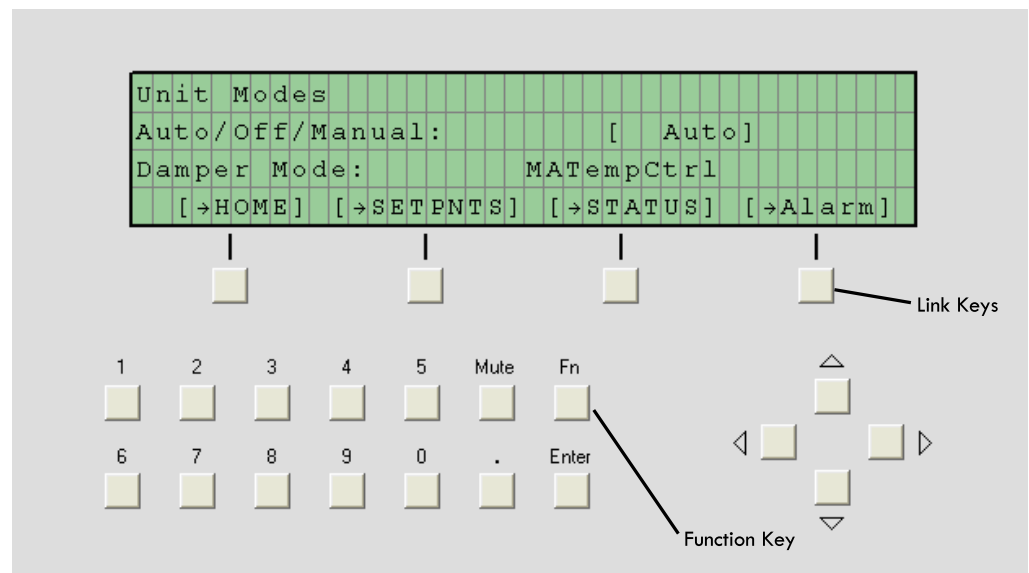

Figure 4. Menu selection tree for BACview

UNIT MODES HOTKEY - 2

Auto/Off/Man

- Auto
- Off
- Manual

Damper Mode

- MA Temp Ctrl
- Bldg Pressure Ctrl
- Manual Ctrl

Home

Setpoints



Menu Selection

Status

Alarm

SET POINTS HOTKEY - 3

Htg Occupied	°F	range 55-90
Htg Setback	°F	range 40-80
Htg Min DA	°F	range 40-130
Htg Max DA	°F	range 55-130
Clg Occupied	°F	range 61-96
Clg Setback	°F	range 75-130
Clg Min DA	°F	range 40-130
Clg Max DA	°F	range 55-130
Man Vent	%OA	range 0-100
Mixed Air	°F	range 30-80
Bldg Prs	"WC	range -0.05-+0.05
Min Vent	%	range 0-100
Economizer Temp	°F	range 40-80
Freeze Stat	°F	range 35-80
Home		
Status		
Alarm		
Resets		



Menu Selection

STATUS MENU HOTKEY - 4

Note: The Status Menu always displays the current status of the fan, burner and cooling.

Room Temp	°F
OA Temp	°F
DA Temp	°F
MA Temp	°F
Outside Air	%
Bldg Pres	"wc
Fan Cycles	
Fan Hours	
Bnr Cycles	
Bnr Hours	
Clg Cycles	
Clg Hours	
Damper	VDC
Burner	VCD
Safety Ckt	Open/Closed
ActEQ Temp	°F
MaxEQ Temp	°F
User In	
User Out	%
Home	
Alarm	
Resets	
Schedules	

ALARM HOTKEY - 1

Alarm History (64 Most Recent)

- Active Critical Alarms
- Active Non-Critical Alarms
- Alarms Return-To-Normal
- Previous

RESETS HOTKEY - 6

- Alarm
- Burner Reset
- Fan Count
- Cooling Reset
- Calibrate



Menu Selection

Home
Schedules
Clock Set
Help

SCHEDULES HOTKEY- 7

Daily

- Schedule1 (typical 1 through 4)
 - Use — yes/no
 - Start Time — hr:min
 - Stop Time— hr:min
 - DAYS — SUN, MON, TUE, WED, THU, FRI, SAT
 - Previous
 - Next
 - Home
 - Logout

Holiday

- Holiday1 (typical 1 through 12)
 - Use yes/no
 - Start Time hr:min
 - Stop Time hr:min
 - Month (1-12)
 - Day(1-31)
 - Previous
 - Next
 - Home
 - Logout

Override

- Override1 (typical 1 through 2)
 - Use yes/no
 - Start Time hr:min
 - Stop Time hr:min
 - Month (1-12)
 - Day (1-31)
 - Previous
 - Next
 - Home
 - Logout

USER CONFIGURABLE OUTPUT HOTKEY - 8

PID Select — Direct Acting/Reverse Acting

High Input Value



Menu Selection

Low Output Value
User Control Setpoint
Maximum User Setpoint
Minimum User Setpoint
Previous
Home
Setpoints
Help

CLOCKSET HOTKEY - 0

Time hh:mm:ss
Date dd-mm-yy
Previous
DST

- Enable No/Yes
- Sou Hem No/Yes
- 06Beg Apr /02
- 06End Oct /29
- 07Beg Apr /01
- 07End Oct /28
- 08Beg Apr /06
- 08End Oct /26
- 09Beg Apr /05
- 09En d Oct /25

HELP HOTKEY - 5

Fan Sequence
Room Sensor
Heating Sequence
Cooling Sequence
Calibrate Sequence
Schedule Sequence
Previous
Home



Menu Selection

Alarm

Fuel Select

FUEL SELECT HOTKEY - 9

Fuel Type Natural Gas/Propane

Login

Home

Previous

Unit Modes



Thermostat Output Curve

10 K Ohms Thermistor Output Curve

Figure 5. Uses FG.figure#

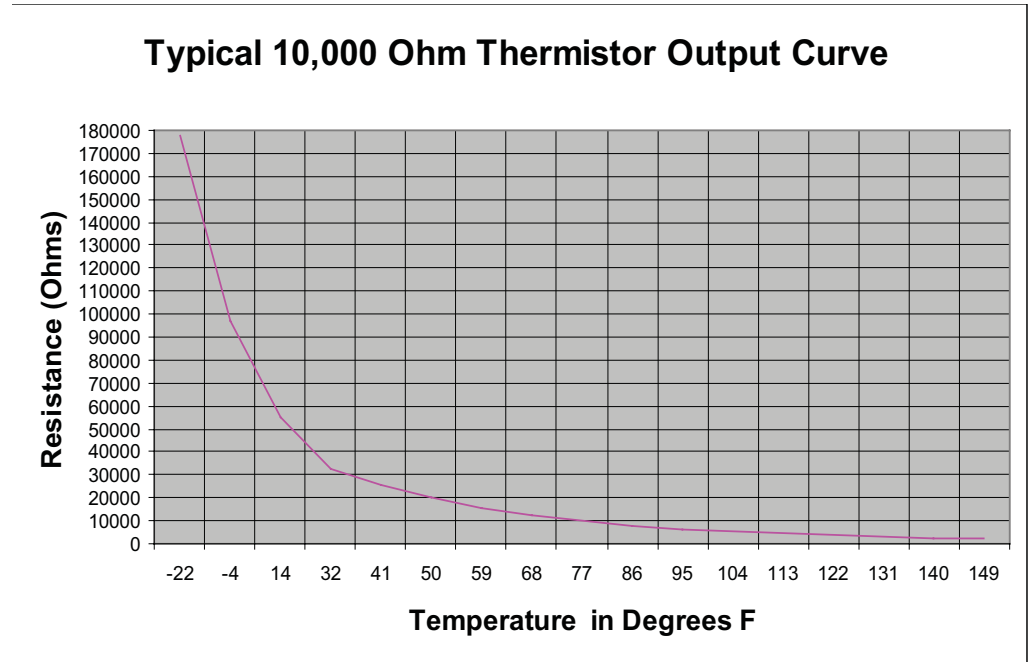
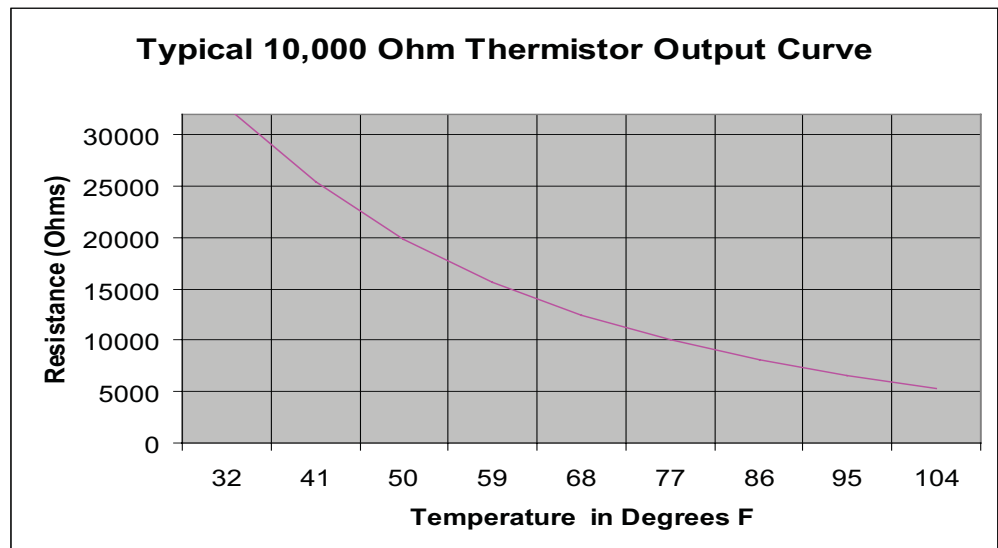
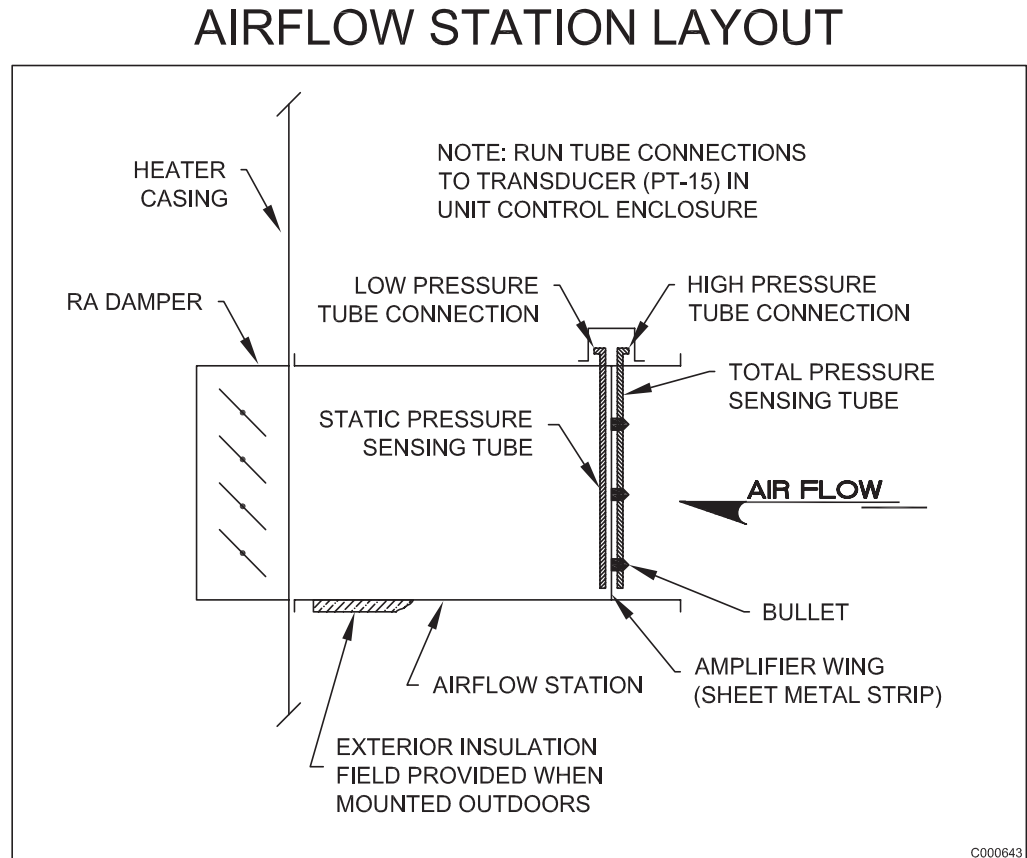

Figure 6. Uses FG.figure#



Airflow Station Layout

Figure 7. Airflow station layout





I/O Zone 583 Controller Specifications

POWER REQUIREMENTS. 24VAC \pm 10%, 20VA

NETWORK COMMUNICATION

BACnet (native), Modbus RTU, or N2 bus at up to 76.8K baud or 156K baud over ARCnet. LonWorks using plug-in communications board.

USER INTERFACE

MDT: modulating discharge temperature control with manually adjusted potentiometer at remote panel.

MRT: modulating room temperature control with manually adjusted potentiometer at remote panel.

MRT-Pro: modulating room temperature control with intelligent room thermostat.

MRT-Expert: modulating room temperature control with intelligent room sensor and BACview LCD control panel.

MEMORY

1M bytes of flash memory and 512K

bytes of non-volatile battery-backed

RAM

REALTIME CLOCK

Battery-backed to keep time in event of power failure.

TEMPERATURE OPERATING RANGE

0°F to 130°F, 10% to 95% RH non-condensing

INPUTS/OUTPUTS

8 Universal Inputs

- Inputs 1 & 2
 - Dry, thermistor, 0-5VDC
- Inputs 3 - 6
 - ω Dry, thermistor
- Inputs 7 & 8
 - 1k -10k pot
- 5 Digital Outputs
 - Relay contacts rated at 1A Resistive @ 24VAC



I/O Zone 583 Controller Specifications

- LED indication
- 3 Analog Outputs
 - 0 - 10 VDC

OUTPUT ASSIGNMENTS - ANALOG

AO1 Burner firing rate (to signal conditioner) 0 - 10 VDC

AO2 RA or Mixing Damper Control/ User Configured 0 - 10VDC

AO3 Unassigned

OUTPUT ASSIGNMENTS - DIGITAL

DO1 Unit Enable

DO2 Burner Enable

DO3 Cooling Enable

DO4 Alarm

DO5 Pilot to Main Flame Sensor Changeover Switch

INPUT ASSIGNMENTS - UNIVERSAL

IN1 Pressure Transducer for Building Pressure Control or User Configured

IN2 Pressure Transducer for Flow Station

IN3 Multiplexed

- 100% Outside Air/100% Output
- Flame Failure Alarm
- Safety Circuit Status
- Manual/Mixed Air Dmpr Control

IN4 Multiplexed

- Auxiliary Unit Enable
- Clogged Filter
- Fan Status
- Burner Status

IN5 Outside Air sensor

IN6 Discharge Air sensor

IN7 Unit Enable/Remote Setpoint

IN8 Damper Control

RNET MRT-Pro or Room Air sensor

Typical Wiring Schematic

Figure 8. Non-recirculating with evap DFOA and DFIA model diagram

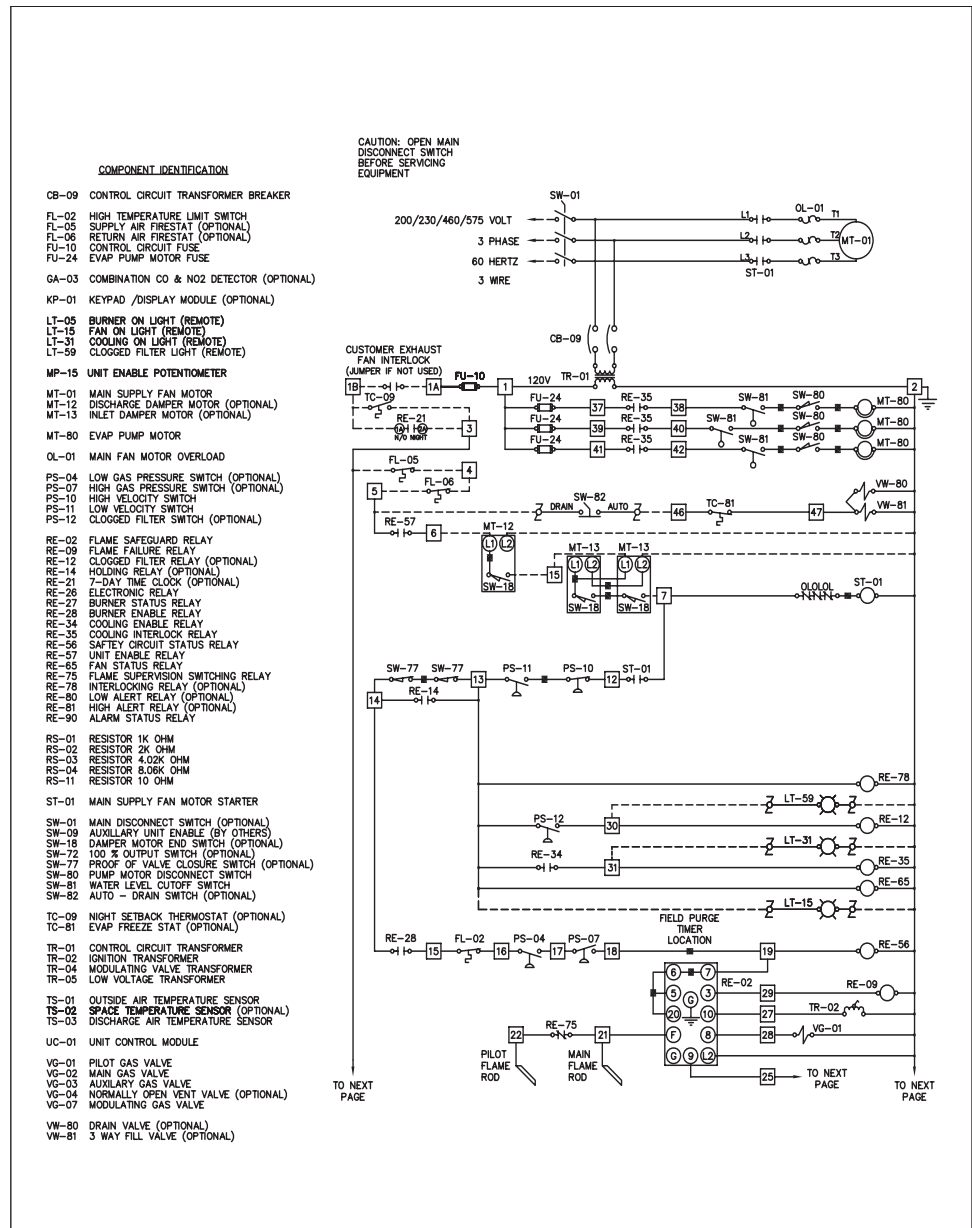

Figure 9. Non-recirculating with evap DFOA and DFIA model diagram

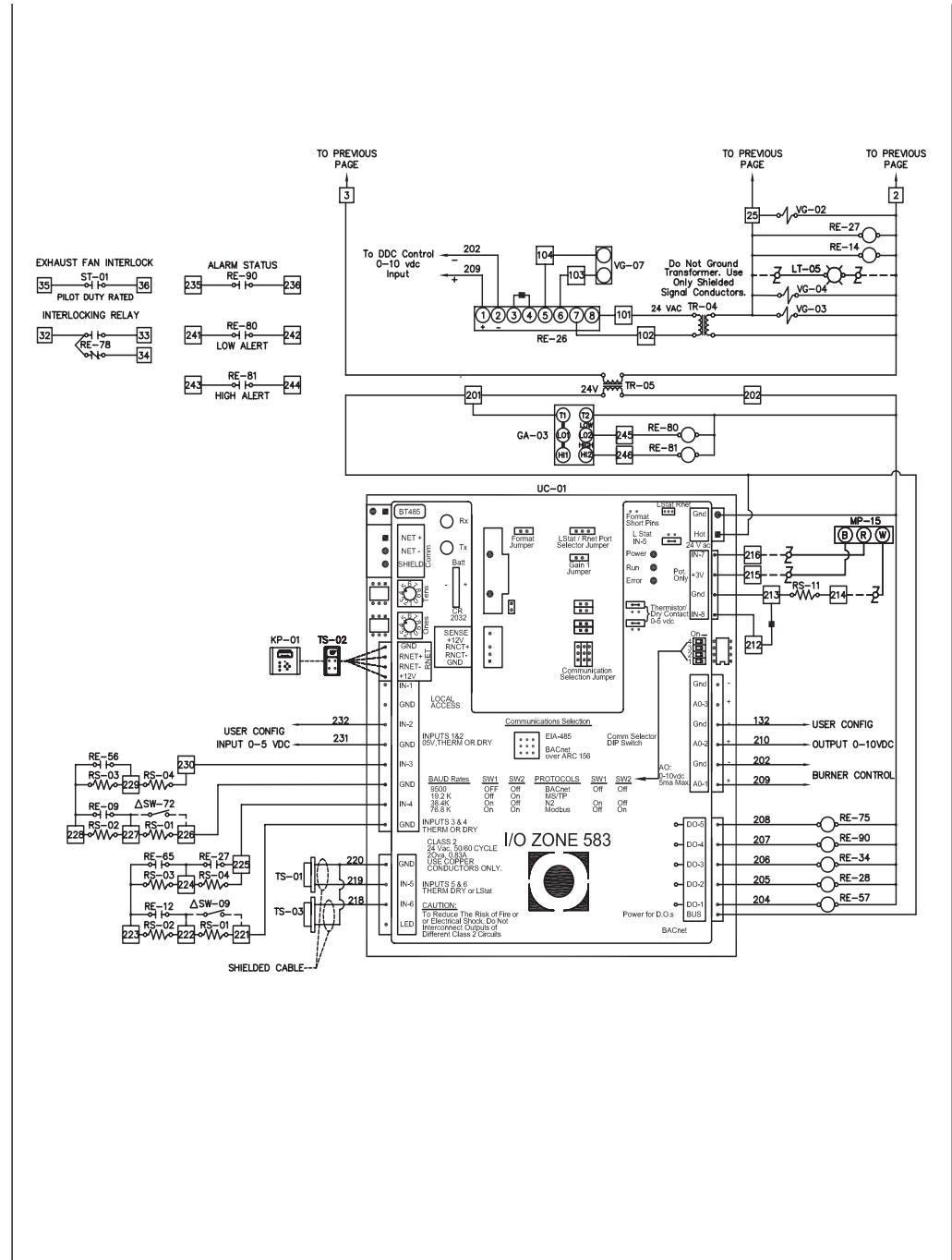

Figure 10. Recirculating DFOA and DFIA model diagrams

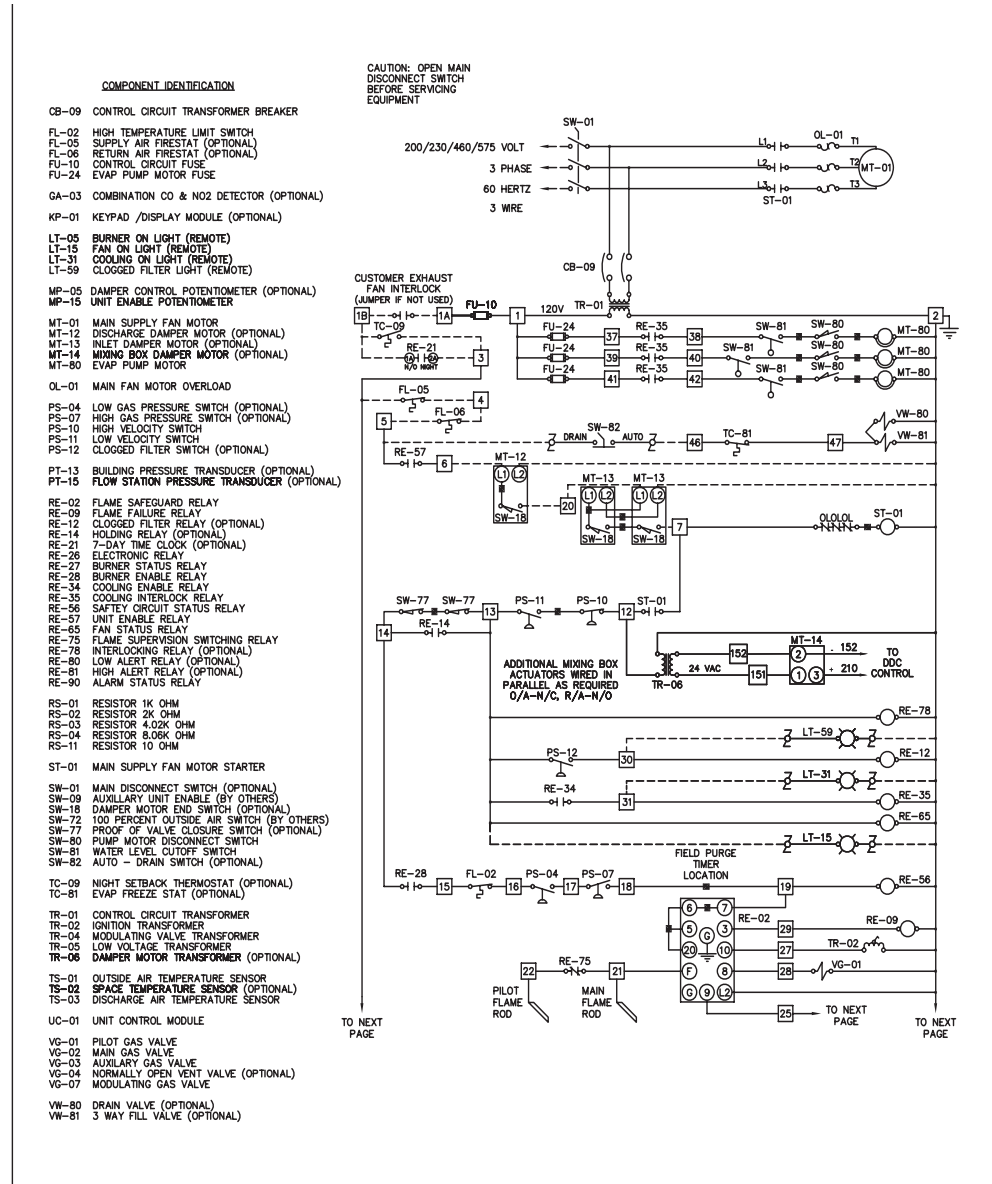
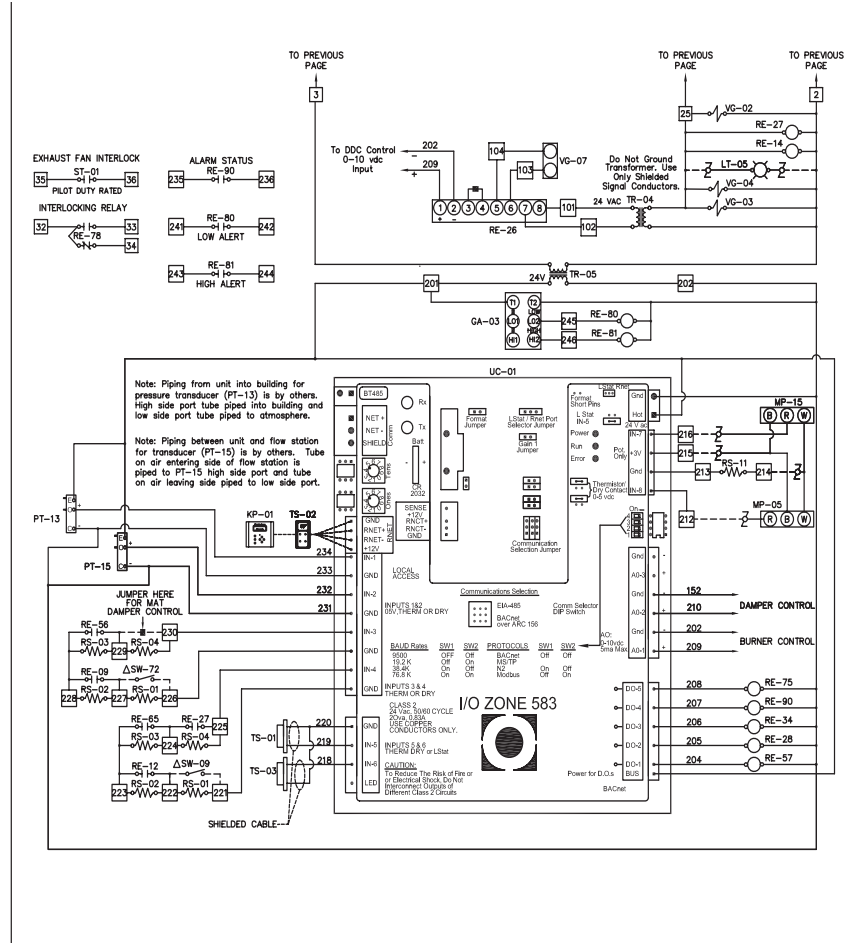

Figure 11. Recirculating DFOA and DFIA model diagram





Typical Wiring Schematic



Trane
A business of American Standard Companies
www.trane.com

*For more information, contact your local Trane
office or e-mail us at comfort@trane.com*

Literature Order Number	MUA-SVP01A-EN
-------------------------	---------------

Date	January 2007
------	--------------

Supersedes	New
------------	-----

Trane has a policy of continuous product and product data improvement and reserves the right to change design and specifications without notice.