

Creda

S420E

Installation & User Instructions

You must read these instructions prior to using the appliance and retain them for future reference.



For more information on our exciting product range ring
Creda Answer Centre 08701 54 64 74

OR



Visit us on the **NET** at
<http://www.creda.co.uk>

Our site invites you to make use of our **interactive cookbook** and **product selector**. Feel free to **browse our product range** to see what's **bubbling away** at the moment or to **ask for help** on our products and services

Creda

General Domestic Appliances Ltd. Morley Way Peterborough PE2 9JB
Creda Answer Centre 08701 54 64 74
Web <http://www.creda.co.uk>

It may be necessary from time to time to change the specification outlined in this booklet without notice. Any change which is made will not affect your statutory rights.

Contents

| | |
|--|------------|
| Introduction | 4 |
| Safety Information | 5 |
| Features | 7 |
| Controls | 8 |
| Oven Timer Operation | 9 |
| Using the Top Oven for Solarplus Grilling | 15 |
| Grill Pan and Handle | 16 |
| Operation when using Top Oven for Grilling | 17 |
| Solarplus Grill Chart | 18 |
| Using the Top Oven as a Convection Oven | 19 |
| Operation when using the Top Oven as a Convection Oven | 20 |
| Using the Main Oven for Fan Cooking | 21 |
| Using the Main Oven for Other Functions | 22 |
| Temperature Conversion Chart | 24 |
| Oven Temperature Charts | 25 |
| Cooking Results Not Satisfactory? | 27 |
| Care and Cleaning | 28 |
| Installation | 32 |
| Something Wrong? | 36 |
| Key Contacts | Back Cover |

Introduction

Your new appliance is guaranteed* and will give lasting service. This guarantee is only applicable if the appliance has been installed in accordance with the installation instructions detailed in this booklet.

To help make best use of your cooking equipment, please read this booklet carefully.

The cooker is designed specifically for domestic use and responsibility will not be accepted for use in any other installation.

**When the cooker is first used an odour may be emitted,
this will cease after a period of use**

When first using the cooker ensure that the room is well ventilated (e.g. open a window or use an extractor fan) and that persons who may be sensitive to the odour avoid any fumes. It is suggested that any pets be removed from the room until the smell has ceased. This odour is due to temporary finish on oven liners and elements and also any moisture absorbed by the insulation.

*** The guarantee is subject to the provisions that the appliance:**

- (a) Has been used solely in accordance with the Users Instruction Book.**
- (b) Has been properly connected to a suitable supply voltage as stated on the rating plate attached to this equipment.**
- (c) Has not been subjected to misuse or accident or been modified or repaired by any person other than the authorised employee or agent.**
- (d) Has been correctly installed.**

Disposal of your product

To minimise the risk of injury to children please dispose of your product carefully and safely. Remove all doors and lids. Remove the mains cable (where fitted) by cutting off flush with the appliance and always ensure that no plug is left in a condition where it could be connected to the electricity supply.

To help the environment, Local Authority instructions should be followed for the disposal of you product.

This appliance conforms to the following EEC Directives:

Electromagnetic Compatibility
89/336/EEC
92/31/EEC
93/68/EEC

Low Voltage Equipment
73/23/EEC
93/68/EEC



Safety Information

**When used properly your appliance is completely safe but as with any electrical product there are certain precautions that must be observed.
PLEASE READ THE PRECAUTIONS BELOW BEFORE USING YOUR APPLIANCE.**

Always

- Always make sure you remove all packaging and literature from inside the oven and grill compartments before switching on for the first time.
- Always make sure you understand the controls prior to using the appliance.
- Always keep children away from the appliance when in use as the surfaces will get extremely hot during and after cooking.
- Always make sure all controls are turned off when you have finished cooking and when not in use.
- Always stand back when opening an oven door to allow any build up of steam or heat to disperse.
- Always use dry, good quality oven gloves when removing items from the oven/grill.
- Always take care to avoid heat/steam burns when operating the controls.
- Always turn off the electricity supply at the wall switch before cleaning and allow the appliance to cool.
- Always make sure the shelves are in the correct position before switching on the oven.
- Always keep the oven and grill doors closed when the appliance is not in use.
- Always take care when removing utensils from the top oven when the main oven is in use as the contents may be hot.
- Always keep the appliance clean as a build up of grease or fat from cooking can cause a fire.
- Always follow the basic principles of food handling and hygiene to prevent the possibility of bacterial growth.
- Always keep ventilation slots clear of obstructions.
- Always refer servicing to a qualified appliance service engineer.
- During use the oven becomes hot. Care should be taken to avoid touching heating elements inside the oven,

SAFETY ADVICE

IN THE EVENT OF A CHIP PAN OR ANY OTHER PAN FIRE:

1. TURN OFF THE COOKER APPLIANCE AT THE WALL SWITCH.
2. COVER THE PAN WITH A FIRE BLANKET OR DAMP CLOTH, this will smother the flames and extinguish the fire.
3. LEAVE THE PAN TO COOL FOR AT LEAST 60 MINUTES BEFORE MOVING IT. Injuries are often caused by picking up a hot pan and rushing outside with it. NEVER USE A FIRE EXTINGUISHER TO PUT OUT A PAN FIRE as the force of the extinguisher is likely to tip the pan over. Never use water to extinguish oil or fat fires.

Safety Information

Never

- Never leave children unsupervised where a cooking appliance is installed as all cooking surfaces will be hot during and after use.
- Never allow anyone to sit or stand on any part of the appliance.
- Never store items above the appliance that children may attempt to reach.
- Never remove the oven shelves whilst the oven is hot.
- Never heat up unopened food containers as pressure can build up causing the container to burst.
- Never store chemicals, food stuffs or pressurised containers in or on the appliance, or in cabinets immediately above or next to the appliance.
- Never operate the grill with the door closed as this will cause the appliance to overheat.
- Never use the appliance as a room heater.
- Never use the grill to warm plates.
- Never dry any items on the oven doors.
- Never install the appliance next to curtains or other soft furnishings.
- Never allow children to play with the appliance controls.
- Never use 'steam cleaners'.

Features

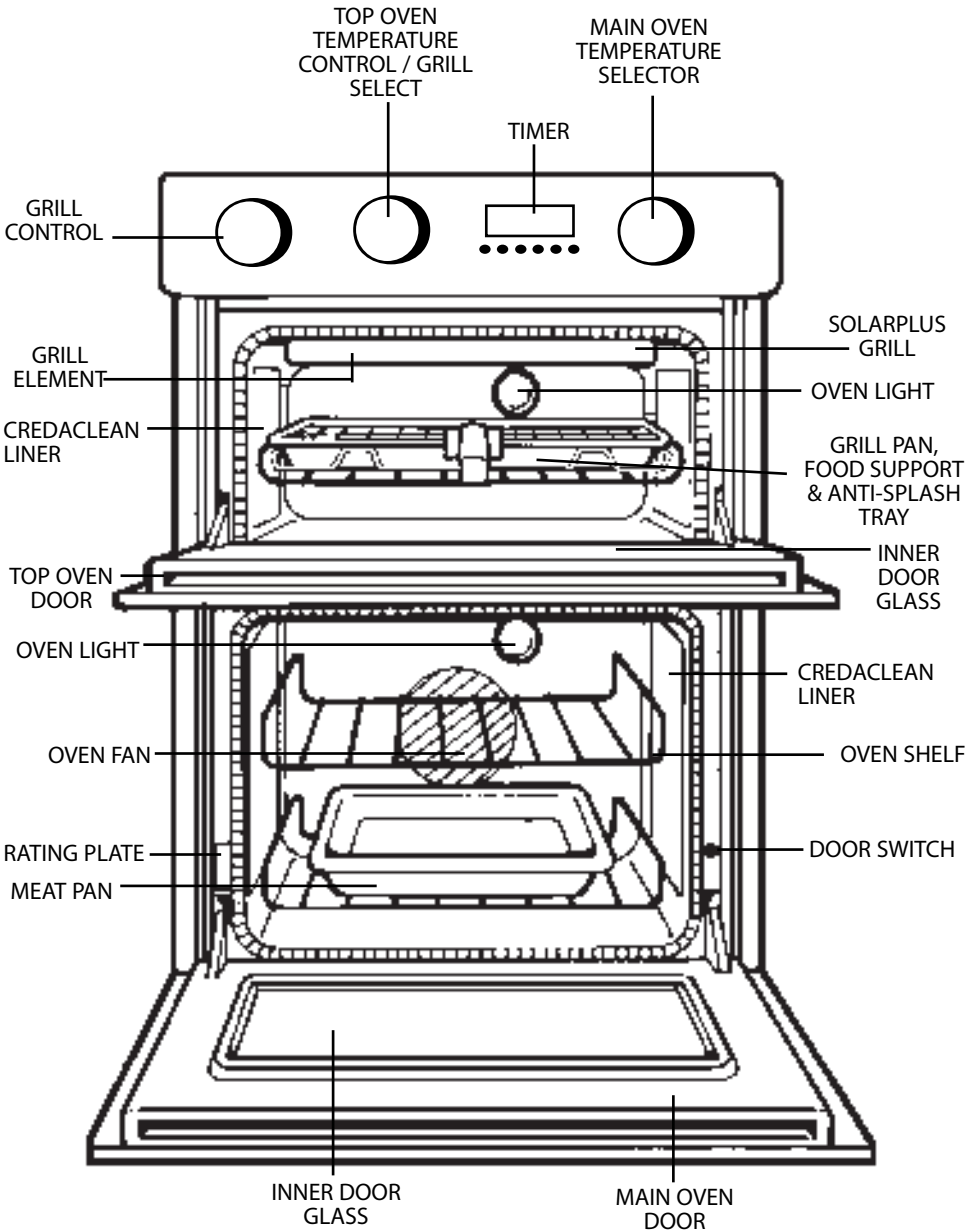

Controls

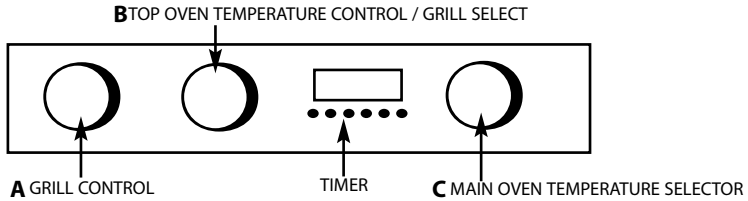

Control Markings

| Control Knob | Description | Function |
|--------------|---|---|
| A | Grill Setting Control | <p>Selects the heat at which the grill will cook the food.</p> <p>1 – 6 Grill Settings Control: 1 = Low, 6 = High</p> <p>Note: To grill you must first select a grill function using control (B).</p> |
| B | Top Oven Temperature & Grill Selection Control | <div style="border: 1px solid black; padding: 2px; margin-bottom: 5px;"> 100 - 220 </div> <p>Selects the cooking temperature (Degrees Centigrade) when using the top oven as a conventional oven.</p> <div style="border: 1px solid black; padding: 2px; margin-bottom: 5px;"> Half Grill </div> <p>Switches the top oven to “Half Grill” mode.</p> <div style="border: 1px solid black; padding: 2px;"> Full Grill </div> <p>Switches the top oven to “Full Grill” mode.</p> |
| C | Main Oven Temperature & Function Control | <div style="border: 1px solid black; padding: 2px; margin-bottom: 5px;"> Fan Only </div> <p>Fan Only Setting - This is used to decrease the amount of time required to defrost food items.</p> <div style="border: 1px solid black; padding: 2px; margin-bottom: 5px;"> Oven Light </div> <p>Oven Light Only - Switches on the Main Oven Interior Light Only.</p> <div style="border: 1px solid black; padding: 2px;"> 80 - 230 </div> <p>Main Oven Temperature Scale (In Degrees Centigrade). - When cooking select the required cooking temperature.</p> |

Cooling Fan: A gentle flow of air will be blown below the control panel when any selector switch is used.
Note: Whenever the appliance has been used, the cooling fan may run on or restart itself after all the controls have been turned off. This indicates that the appliance is still warm.

Oven Interior Lights The oven lights are operated when their respective oven control is used. (**N.B.** Not all models have a top oven interior light). The main oven has a light only position.

Slow Cooking ‘S’ The main oven has a Slow Cook Setting, ‘S’; this can be used for slow cooking, keeping food warm and warming plates for a short period.

Element and Fan Cut-off The oven is fitted with a safety device which disconnects the heating element and oven fan when the door is opened. The heating element and oven fan will not operate until the oven door is closed.

Note: It is advisable to check that all oven controls have been switched off when you have finished using the appliance.

Oven Timer Operation

The oven timer offers you the following features:

1. Time of Day
2. Automatic Cooking
3. Minute Minder

Automatic Cooking

The Main Oven (only) can be controlled by the automatic timer. Never operate the grill or top oven when the main oven is set to cook automatically because the oven cavity can become warm and this may cause bacterial growth in food.

Hints on Automatic Cooking

1. Select foods which will take the same time to cook and require approximately the same temperature.
2. Set the oven timer so that the food has just finished or about to finish cooking on your return to the oven. This will ensure the food has not cooled down and does not require reheating before serving.
3. Food should be as cold as possible when it goes into the oven, ideally straight from the refrigerator. Frozen meat and poultry should be thawed thoroughly before it is put in the oven.
4. We advise that warm food should never be placed in the oven if there is to be a delay period. Stews prepared by frying the meat and vegetables should be cooked as soon as possible.
5. We advise dishes containing left-over cooked poultry or meat, for example Shepherds Pie, should not be cooked automatically if there is to be a delay period.
6. Stews and joints should be cooked by the long slow method, so that the delay period is kept to a minimum.
7. On warm days, to prevent harmful bacterial growth in certain foods (ie poultry, joints, etc) the delayed start should be kept to a minimum.
8. Wine or beer may ferment and cream may curdle during the delay period, so it is best to add these ingredients just before serving.
9. Foods which discolour should be protected by coating in fat or tossing in water to which lemon juice has been added, prior to placing food in the oven.
10. Dishes containing liquid should not be filled too full to prevent boiling over.
11. Food should be well sealed (but not airtight) in a container to prevent the loss of liquid during cooking. Aluminium foil gives a good seal.
12. Ensure food is cooked thoroughly before serving.

Timer Operation

1. Make sure all oven controls are turned **Off**.
2. Check that the electricity supply to the oven is turned **On**.
3. Check that the oven clock is at the right time of day.

Know Your Timer

CLOCKFACE

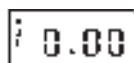

The timer incorporates a 24 hour clock.

Ensure the correct time of day is always set, before using your cooker.

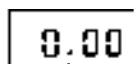
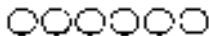

SYMBOLS

A 'bell' symbol will light up when you select a Minute Minder Period and will remain lit for the period set.

At the end of the Minute Minder Period, the timer will emit an audible tone and the 'bell' symbol will disappear.

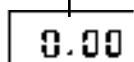
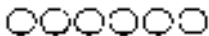

The 'cookpot' symbol will light up either:-

- When the timer is in manual mode, or
- During the actual Cook Period.

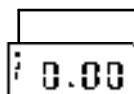
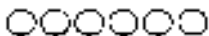

'AUTO' will light up:-

- When the timer is first turned on it will flash. It will go out when a time of day is set or when the timer is set to manual.

The 'AUTO' symbol will flash at the end of an Auto Cooking programme to indicate that the programme has finished.

(When the 'AUTO' symbol is flashing, to return the oven to Manual operation, turn the oven controls off, ensure that the correct time of day is set, and press the "Manual" button - The 'AUTO' symbol will go out.)



TIMER FUNCTION BUTTONS



Here you can set a time period of up to 23 hours 59 minutes, that will count down. When it reaches zero, the timer will emit an audible tone.

For Example: If you set 20 minutes, the audible tone will occur 20 minutes later.

AUTO COOKING PROGRAMME



Cook Period is the actual length of time for which, the timer will switch the oven(s) on as part of an "Auto Cooking" programme.
(e.g. If you set 2 hours, the food will be cooked for 2 hours).



The time of day at which you want an "Auto Cooking" programme to **end**.

For Example: If you set a "Cook Period" for 2 hours, and "End Time" of 11:00. The timer will switch the oven(s) on at 9:00 and turn the oven(s) off at 11:00. You will hear a audible tone at 11:00, to indicate that the Auto Cooking Programme has finished.

Notes:

- When setting an Auto Cooking programme you will need to set the oven control(s) to the required temperature(s) when you set the timer.
- If an Auto Cooking programme has been set the oven(s) will only operate during the pre-programmed time.



Needs to be pressed to cancel an Auto Cooking programme and return the oven(s) to Manual operation.

"+" and "-" Buttons Used to adjust the various timer function settings.

Electronic Clock and Automatic Oven Timer Operation

SETTING THE TIME OF DAY

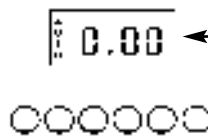

Step 1 Make sure all oven controls are turned Off.

Step 2 Check the electricity supply to the cooker is turned on.

Step 3 When switched on the display will show 0.00 and the Auto symbol, flashing intermittently.

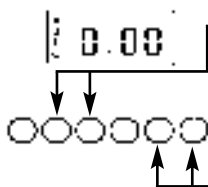

Step 4 Press & hold in both the Cook Period & End Time buttons together.

Step 5 With the Cook Period & End Time buttons still held in, press either the "+" or "-" buttons to set the correct time of day.

Step 6 Release all the buttons simultaneously.

THE TIME OF DAY IS NOW SET.

To change the time of day repeat Steps 4, 5 & 6 above.

Note: You cannot adjust the time of day if the timer has been set for an Auto Cooking Programme.

SETTING THE MINUTE MINDER

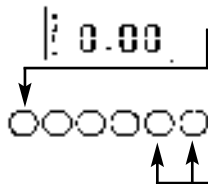

Step 1 Ensure the time of day is set correctly.

Step 2 Press and hold the Minute Minder button.

Step 3 With the Minute Minder button held in, set the required Minute Minder period using the "+" and "-" buttons. A 'bell' symbol will light up.

Release all buttons and the timer display will revert back to the time of day. The 'bell' symbol will remain lit to signify that a Minute Minder period has been set.

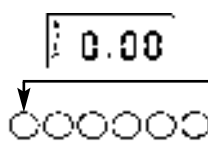

At the end of the set time an audible tone will be heard, and the 'bell' symbol will disappear.

Step 4 To cancel the audible tone press the Minute Minder button.

Note 1 When the Minute Minder has been set, the time remaining can be checked at any time by simply pressing the Minute Minder button.

Note 2 If necessary the Minute Minder can be cancelled before the tone sounds by pressing and holding the Minute Minder button and then at the same time pressing the "-" button until 0.00 appears in the display window.

Electronic Clock and Automatic Oven Timer Operation

AUTO COOKING PROGRAMMES

There are two Auto Cooking programmes that can be selected using your timer:-

- To set the timer to switch the oven(s) On and Off Automatically
- To set timer to switch on immediately and OFF automatically after a set cook period.

a) TO SET THE TIMER TO SWITCH THE OVEN(S) ON AND OFF AUTOMATICALLY

This allows you to cook at a specified time for a chosen period before the oven switches off Automatically.

- Step 1** Check that the correct time of day is set, if not follow instructions for setting the time of day.
Step 2 Place food onto the correct shelf position in the oven and close the oven door(s).

Step 3 Press and hold in the Cook Period button.
The display will read 0.00 with the 'cookpot' symbol lit.

Step 4 With the Cook Period button still held in, set the required Cook Period using the "+" and "-" buttons.

Release the buttons and the timer display will revert to the time of day with the 'Auto' symbol and 'cookpot' symbol lit.

Step 5 Press and hold in the End Time button.
The display will read the earliest possible end time for the Cook Period that you have set above.
The 'Auto' symbol and 'cookpot' symbol will be lit.

Step 6 With the End Time button still held in, use the "+" and "-" buttons to set the 'End Time' (i.e. The time you require the oven to switch off).
Release all the buttons and the timer will revert back to the time of day.

The 'Auto' symbol will remain lit to signify that an Auto Cooking Programme has been set. The 'cookpot' symbol will go out.

Step 7 Turn the oven control(s) to the required temperature, and if necessary select the appropriate oven function.

Note: If your appliance has two ovens: When the timer has been set for one oven it is possible to use the other oven only during the same Automatic programme.

At the end of the Automatic Cook Period the Auto Symbol will flash and an intermittent bleeping sound will be heard.
The audible tone will continue unless cancelled.
The 'Auto' symbol will continue to flash until the timer is returned to Manual operation (see below).

Step 8 Press the Manual button, the audible tone will be cancelled and the oven(s) will be returned to Manual.

Step 9 Turn the oven control(s) to the OFF position.

Electronic Clock and Automatic Oven Timer Operation

Note 1 When cooking automatically the Cook Period can be checked at any time by simply pressing the Cook Period button.

Note 2 When cooking automatically the End Time can be checked at any time by simply pressing the End Time button.

b) TO SET TIMER TO SWITCH ON IMMEDIATELY AND OFF AUTOMATICALLY AFTER A SET COOK PERIOD

- Step 1** Check that the correct time of day is set, if not follow instructions for setting the time of day.
Step 2 Place food onto the correct shelf position in the oven and close the oven door(s).
Step 3 Turn the oven control(s) to the required temperature, and if necessary select the appropriate oven function.

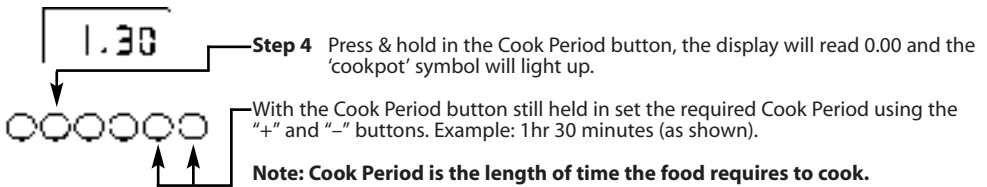

Step 5 Release all buttons.

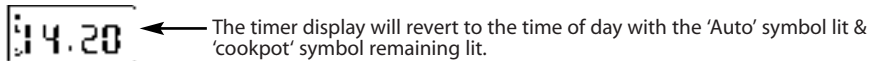

NOTE: The Cookpot symbol disappears
At the end of the Cook Period the 'Auto' symbol will flash and an intermittent audible tone will be heard.

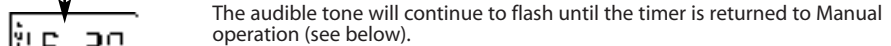

Step 6 Press the Manual button. The audible tone will be cancelled and the oven(s) will be returned to Manual.

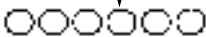

Step 7 Turn the oven control(s) to the OFF position.

Electronic Clock and Automatic Oven Timer Operation

TO CANCEL AN AUTO COOKING PROGRAMME BEFORE THE COOK PERIOD HAS FINISHED.

Step 1 Turn the oven control(s) to the OFF position.

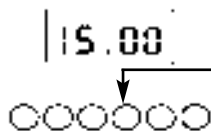

Step 2 Press the Manual button to return the oven(s) to "Manual" operation. The 'Auto' symbol will go out.

Note 1 When cooking automatically the Cook Period can be checked at any time by simply pressing the Cook Period button.

OTHER NOTES ON TIMER OPERATION

1. When cooking Automatically the Cook Period can be checked at any time simply by pressing the Cook Period button.
2. When cooking Automatically the End Time can be checked at any time by simply pressing the End Time button.
3. Having set a Cook Period and End Time an electronic device stores the information. The device within the timer will switch the oven(s) on and off at the required times.
4. When setting an Auto Cooking Programme and a mistake is made, to clear:-
 - (d) Press & release the Manual button.
 - (e) Start the sequence again.
5. If at any time the display shows three flashing zero's 0.00 and 'Auto', it is likely that the electricity supply to the oven has been interrupted. Reset the timer to the correct time of day.
Food in the oven may, therefore, not have been cooked, before serving check food is thoroughly heated and completely cooked.
6. To set each function always press and hold the required function button and at the same time press "+" or "-" buttons.

Using the Top Oven for Solarplus Grilling

Your cooker is not fitted with a conventional grill. **Creda** have developed a Solarplus high speed grill which is designed to reduce your grilling times. It is quicker because it takes less time to warm up from cold. Conventional grills require 5 minutes pre-heat before food is placed beneath them, but for normal grilling the Solarplus grill can be used directly from cold without any pre-heat.

However, when toasting, optimum performance is achieved by pre-heating the grill for about 1 minute.

Note: You will notice that the grill elements are protected by a wire mesh. This stops you from touching live parts.

DO NOT under any circumstances insert objects into the grill mesh as this could damage the element wire, break the glass tubes or if the grill is on, cause electric shock.

During use the mesh may become soiled. Do not attempt to clean it while the grill is still on. Turn off at the control and allow to cool before cleaning. Care must be taken to ensure the grill mesh is not distorted – do not store the grill pan handle on the food support when the shelf is in the highest position.

**IMPORTANT
GRILLING SHOULD NEVER BE UNDERTAKEN WITH THE GRILL/TOP OVEN DOOR
CLOSED.**

Grill Pan and Handle

The grill pan handle is detachable from the pan, to facilitate cleaning and storage.
The grill pan handle can be fixed as follows:

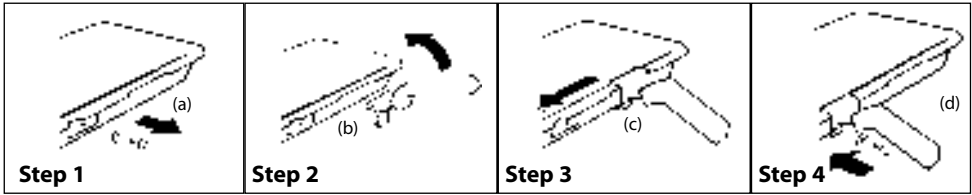

- Step 1** Remove the screw and washers from the grill pan bracket (a).
- Step 2** Tilt the handle over the recess (b).
- Step 3** Slide it towards the centre of the pan (c).
- Step 4** Locate the handle over the bracket (d).
For a fixed handle, replace the screw and washers and ensure they are fully tightened up. If a detachable handle is required, do not replace the screw and washers.

Note: If a fixed handle is required, the grill pan cannot be kept in the main oven with the door closed but may be stored in the top oven with the door closed, when the top oven is not in use..

Grill Pan Food Support and Anti-Splash Tray

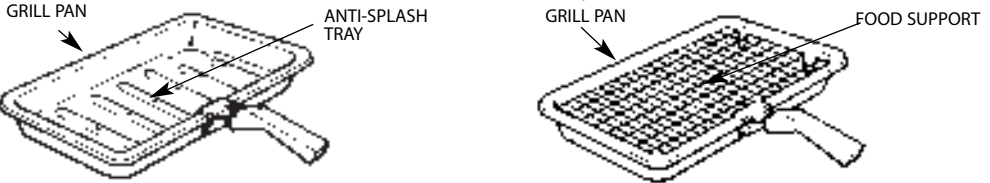

Note: To stop fat splashing onto the grill mesh, it is important to use the anti-splash tray as shown in the grilling chart. Always clean the grill pan, anti-splash tray and food support after each use.

Top Oven Shelf Positioning for Grilling

ENSURE SHELVES ARE FITTED CORRECT WAY UP.

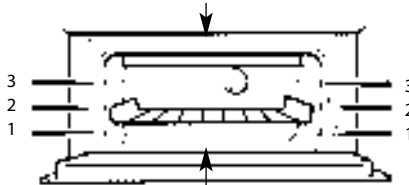

DO NOT PLACE FOOD/UTENSILS DIRECTLY ON THE OVEN FLOOR

NOTE: Preheat the grill if indicated on grill chart.
The grill pan must be placed on the correct shelf and positioned centrally under the grill element.
Leave the control at 6 for toast, and for fast cooking of foods.
For thicker foods requiring longer cooking, turn the switch to a lower setting after the initial sealing on both sides at 6. The thicker the food, the lower the control should be set.
DO NOT line the grill pan with aluminium foil, as this increases the amount of fat spitting which can cause a fire.
After use always return both controls to their OFF (0) position.

Operation when using the Top Oven for Grilling

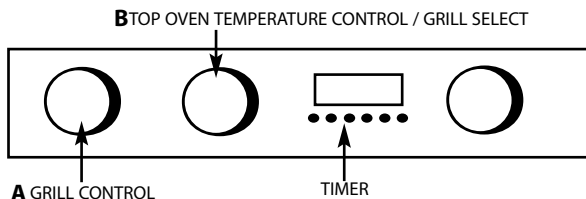

Step 1 Ensure that the timer is set to manual.

Step 2 Place the rod shelf in the correct position (see Grilling Guide). position the grill pan on the rod shelf, position centrally under the grill element. Leave the door fully open.

Step 3 Turn knob (B) clockwise to select grill function setting:

Set to: For Half Grill (Left hand side only).



For Full Grill.

NOTE: As you turn past the end of the oven temperature scale you will feel resistance on the knob – continue turning clockwise until the grill setting position is selected.

Step 4 Turn knob (A) clockwise to select the Grill Setting (1–6). (1=Low, 6=High).

Grill Controls Example:

= Full Grill Function

= Maximum Grill Setting

NOTE: Do not grill with the grill/top oven door closed.

Step 5 After use, turn both controls A & B anti clockwise to their off (●) position.

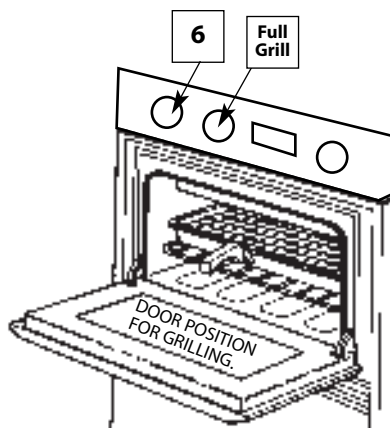

DO NOT allow young children near to the appliance when the grill is in use as the surfaces get extremely hot.

Guide to Solarplus Grilling

| Food | Preheat for one minute | Shelf Position from base of oven. | Setting | Approximate Cooking Time | Pan to be used |
|---|-------------------------------|--|---|--|--|
| Toasting of Bread Products | Setting 6 | 2 | Setting 6 | 3-5 minutes | Grill pan and food support |
| Small cuts of meat, Sausage, Bacon | None | 2 | Setting 6 for 4 minutes then reduce to Setting 5 | 10-20 minutes | Grill pan, anti-splash trivet & food support |
| Chops etc. Gammon steaks | None | 2 | Setting 6 for 6-8 minutes then reduce to Setting 4 or 5 | 20-30 minutes | Grill pan, anti-splash trivet & food support |
| Fish Whole Fillets Fingers | None None None | 2 | Setting 6 | 6-10 minutes 10-15 minutes 10-15 minutes | Grill pan and food support |
| Pre-cooked Potato products | None | 2 | Setting 5 | 10-12 minutes | Grill pan and food support |
| Pizzas | None | 2 | Setting 4 | 10-12 minutes | Grill pan and food support |
| Browning of food eg. Cauliflower Cheese | Setting 6 | 1 | Setting 6 | 5-10 minutes | Dish placed directly on the shelf |

Using the Top Oven as a Convection Oven

The top oven should be used to cook small quantities of food. The oven is designed so that the grill element operates at a reduced heat output, this is combined with a heating element situated underneath the floor of the oven. To ensure even cooking of the food it is important that cooking utensils are positioned correctly on the oven shelf so that the element is directly above. As a guide, the front of the utensil should be approx. 100mm (4") from the front of the shelf.

Note: Charts are a guide only, to suit personal taste and requirements, it may be necessary to increase or decrease temperatures by 10°C. It may also be necessary to increase or decrease cooking times.

Shelf Positioning

ENSURE SHELVES ARE FITTED THE CORRECT WAY UP

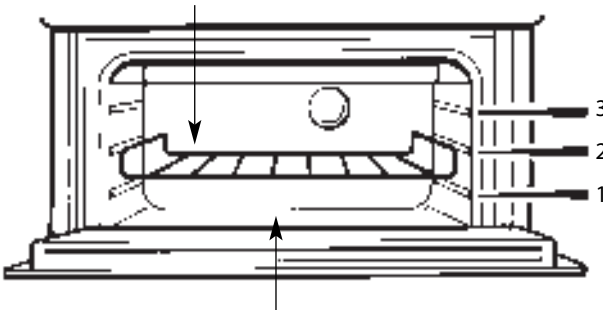

DO NOT PLACE FOOD/UTENSILS DIRECTLY ON THE OVEN FLOOR

There should always be at least 25mm (1 inch) between the top of the food and the grill element.

WARNING: Items stored in the top oven will get hot when the main oven is in use.

DO NOT allow young children near to the appliance when the top oven is in use as the surfaces get extremely hot.

Operation when using the Top Oven as a Convection Oven

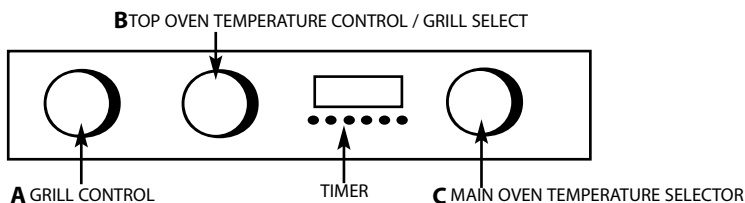

Step 1 Check that the timer is in manual.

Step 2 Place the shelf in the correct position (see Oven Temperature Charts).

Step 3 Select the required cooking temperature (100–220°C) using control (B) (see Top Oven Temperature Charts).

The pilot light will immediately come on, and remain on until the oven reaches the required temperature. The light will then automatically go off and on during cooking as the oven thermostat maintains the correct temperature.

Step 4 Place the food on the shelf directly below the element ensuring the oven door is closed.

NOTE: At the end of your cooking, always return control (B) to the OFF (●) position.

Plate Warming

Place the plates/dishes on shelf position 1 from the base of the top oven, and turn top oven temperature and grill selection control (B) to 100°C for 10-15 minutes.

Never use the grill setting control (A) when warming plates.

Top Oven Utensils

Do Not use: Meat Pans and Baking Trays larger than – 225mm x 300mm (9"x12")

DO NOT use the main oven meat pan as a meat pan in the top oven, as the air circulation will be seriously restricted.

Using the Main Oven for Fan Cooking

Since a circulaire fan oven heats up more quickly and generally cooks food at a lower temperature than a conventional oven, pre-heating is often unnecessary. For "Oven Temperature Charts" later in book.

Note: Charts are a guide only, to suit personal taste and requirements, it may be necessary to increase or decrease temperatures by 10°C. It may also be necessary to increase or decrease cooking times.

Main Oven Shelf Positioning for Fan Oven

Most foods will cook satisfactorily on any shelf position, due to even distribution of heat in the main oven, but the shelves must be evenly spaced.

The top oven rod shelf can be used in the main oven when cooking large quantities of food. (N.B. Maximum 2 shelves in the main oven).

Food or utensils should never be placed directly on the floor of the oven for cooking.

DO NOT allow young children near to the appliance when the main oven is in use as the surfaces get extremely hot.

Main Oven Utensils

Do Not Use: Meat Pans larger than – 375mm x 300mm (15"x12")
Baking Trays larger than – 325mm x 250mm (13"x10")

Temperature & Time

When all three shelves are in use to cook large quantities of food, it may be necessary to increase the cooking times given in the temperature charts by a few minutes, to allow for the loss of heat due to extra time taken to load the oven, and the larger mass of food. Baking trays should have an even gap around the oven.

Main Fan Oven Operation

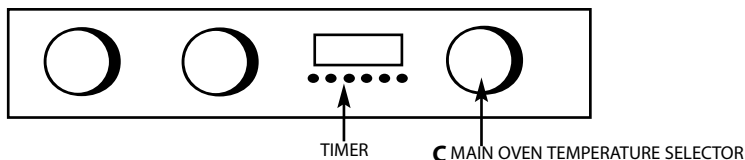

- Step 1 Check that the timer is in manual.
- Step 2 Place the shelf/shelves in the correct position (see Main Oven Temperature Charts).
- Step 3 Place the food centrally on the shelf ensuring the oven door is fully closed.
- Step 4 Select the required cooking temperature (80 to 230°C) by turning control (C) clockwise. The pilot light will immediately come on, and remain on until the oven reaches the required temperature. The light will then automatically go off and on during cooking as the oven thermostat maintains the correct temperature.

Note: When you have finished using your cooker, always return the controls to their OFF (●) position. At the end of the cooking period there may be a momentary puff of steam when the door is opened. This will disperse in a few seconds and is a perfectly normal characteristic of an oven with a good door seal.

Using the Main Oven for other Functions

Fan
Only

Fan Only Setting

Defrosting frozen meat and poultry

Joints of meat and whole birds should be defrosted slowly, preferably in a refrigerator (allowing 5-6 hours per lb.) or at room temperature (allowing 2-3 hours per lb.).

Frozen meat or poultry must be completely defrosted before cooking in the oven.

However, to decrease the amount of time required to defrost food items, a non-heating fan only setting may be selected for the main oven only.

Operation: To assist in defrosting

Place food in the oven and close the oven door.

Turn the Main Oven Temperature and Function Control (C) clockwise to the

Fan
Only setting.

This defrosts by circulating the air around the food, time to defrost will depend on type and size of the food.

NOTES: DO NOT defrost meat and poultry by warming the food through.

Foods ideally suited to defrosting using the fan only setting are cream/cream cakes, butter cream filled cakes, gateaux, cheese cakes, iced cakes, quiches, pastries, biscuits, bread, croissants, fruit and many delicate frozen foods.

If fish, meat and poultry are to be defrosted using the fan only setting, where possible it is recommended that the food should be small & thin.

The items should be placed so that the maximum amount of surface area is exposed to the circulating air, and that they are turned regularly to ensure even defrosting.

Larger cuts of meat and poultry may be defrosted by using the fan only setting up to a maximum weight of 2 kg (4lb 8oz).

It is important to wash both meat and poultry and cooking utensils immediately after defrosting and before cooking. Food should be cooked immediately after defrosting.

It is very important to strictly adhere to the basic principles of food handling and hygiene to prevent the possibility of bacterial growth.

Oven
Light

Light Only Setting

When the Main Oven Temperature & Function Control (C) is turned clockwise to the

Oven
Light setting.

Using the Main Oven for other Functions

'S' SLOW Setting

This is used for slow cooking, keeping food warm and warming plates for short periods. Extra care should be taken when warming bone china, as it may be damaged in a hot oven.

DO NOT place food or plates directly on the oven floor as this could damage both the oven lining and the plates which are being warmed.

Advantages of "SLOW" cooking are:

The oven stays cleaner because there is less splashing.
Timing of food is not as critical, so there is less fear of overcooking.
Inexpensive joints of meat are tenderised.
Fully loading the oven can be economical.
Cooking times can be extended in some cases by up to 2 hours.

Operation:

1. Place the prepared food in the main oven and ensure the door is fully closed.
2. Select 'S' (Slow Cooking Temperature) by turning Main Oven Temperature & Function Control (C) clockwise ensuring the oven door is fully closed.

Storage and re-heating of food:

1. If food is to be frozen or not used immediately, place it in a clean container and cool as soon as possible.
2. Always thaw frozen food completely in the refrigerator before re-heating.
3. Always reheat food thoroughly and ensure it is piping hot before serving.
4. Only re-heat food **once**.

Points to consider when preparing food for "SLOW" cooking:

1. Make sure that the dishes to be used will fit into the oven ensuring enough room for air to circulate.
2. All dishes cooked on the slow setting will require a minimum of 6 hours, however, if they are cooked for 1-2 hours longer then deterioration in their appearance may be noticed.
3. Never cook joints of meat over 2.7kg (6 lb) or poultry over 2.0kg (4lb 8oz).
We do not recommend that joints of meat or poultry are stuffed before cooking on the slow setting.
4. To seal in the meat juices, always cook meat or poultry at 170°C for 30 minutes before wrapping in foil and placing on a rack over a tin (to allow good air circulation) before turning the control to the slow setting and cooking immediately.
5. Always ensure that joints of pork and poultry are thoroughly cooked by checking with a meat thermometer before serving.
6. Always thaw frozen foods completely before cooking. We do not recommend placing frozen food in the oven to cook.
7. Always bring soups, liquids and casseroles to the boil before placing in the oven.
8. Ensure that casserole dishes have a good seal (not airtight) and cover to the top with foil to prevent loss of moisture.
9. Ensure that fruit and vegetables are cut into even sized small pieces to cook properly.
10. Always adjust seasoning before serving.
11. If using dried red kidney beans it is important that the beans are soaked and then boiled for a minimum of 10 minutes before using in any dish to destroy any toxins.
12. When cooking fish or egg dishes it may be necessary to check during cooking to avoid overcooking.

Temperature Conversion Chart

| Gas Mark | °F | Main Conventional Oven | Top Convection Oven | Main Fan Oven |
|-----------------|-----------|-------------------------------|----------------------------|----------------------|
| 1/2 | 250 | 120 | 110 | 100 |
| 1 | 275 | 140 | 130 | 120 |
| 2 | 300 | 150 | 140 | 130 |
| 3 | 325 | 160 | 150 | 140 |
| 4 | 350 | 180 | 170 | 160 |
| 5 | 375 | 190 | 180 | 170 |
| 6 | 400 | 200 | 190 | 180 |
| 7 | 425 | 220 | 210 | 200 |
| 8 | 450 | – | 220 | 210 |
| 9 | 475 | – | – | 220 |

Oven Temperature Charts - Meat

| Food | Main Fan Oven Cooking | | Food | Top Oven Convection Cooking | | Position from Base of Oven | |
|--------------------------------|--|----------------|---|-----------------------------|----------|--|----------------|
| | Pre-heat | Temperature °C | | Time (approx.) | Pre-heat | | Temperature °C |
| Meat | Note: Up to two shelves may be used in this oven. The position of these is not important providing they are evenly spaced. | | | | | | |
| Beef | No | 160/180 | 20-25 mins per 450g (1lb) + 20 mins extra | Yes | 170/180 | 35 mins per 450g (1lb) + 35 mins over | |
| Lamb | No | 160/180 | 25 mins per 450g (1lb) + 25 mins extra | Yes | 190/200 | 35 mins per 450g (1lb) | |
| Pork | No | 160/180 | 25 mins per 450g (1lb) + 25 mins extra | Yes | 170/180 | 40 mins per 450g (1lb) + 40 mins over | |
| Veal | No | 160/170 | 25-30 mins per 450g (1lb) + 25 mins extra | Yes | 190/200 | 40 mins per 450g (1lb) | |
| Chicken/Turkey up to 4kg (8lb) | No | 160/180 | 18-20 mins per 450g (1lb) + 20 mins extra | Yes | 170/180 | 40-45 mins per 450g (1lb) + 40 mins over | Shelf 1 |
| Turkey up to 5.5kg (12lb) | No | 150/160 | 13-15 mins per 450g (1lb) eg. 5kg (11lb) = 143-165 mins | Yes | 190/200 | 40-45 mins per 450g (1lb) | |
| Turkey over 5.5kg (12lb) | No | 150 | 12 mins per 450g (1lb) eg. 10kg (22lb) = 264 mins | Yes | 170/180 | 25-30 mins per 450g (1lb) + 25 mins over | |
| Casserole Stews | No | 140/150 | 1½ - 2 hours | Yes | 190/200 | 25-30 mins per 450g (1lb) | |
| | | | | Yes | 150 | 2-2½ hours | |

COOKING MEAT/POULTRY IN THE TOP OVEN

Small joints of meat up to 1.5kg (3 lbs) and poultry up to 3.6kg (8lbs) can be roasted in a small meat pan in the top oven.

IF USING ALUMINIUM FOIL

1. Never allow foil to touch sides of oven. 2. Never cover interior with foil. 3. Never cover shelves with foil.

The most accurate method of testing the readiness of joints of meat or whole poultry is to insert a meat thermometer into the thickest part of a joint of meat, or the thickest part of poultry thighs, during the cooking period. The meat thermometer will indicate when the required internal temperature has been reached.

| | Beef | Pork | Lamb | Poultry |
|-----------|-------------|----------------|------|---------|
| Rare 60°C | Medium 70°C | Well Done 75°C | 80°C | 90°C |

Oven Temperature Charts - Baking

| Baking | | Main Fan Oven Cooking | | Top Oven Convection Cooking | | | | |
|------------------------------|----------|-----------------------|------------------|------------------------------|----------|----------------|---------------------|----------------------------|
| Food | Pre-heat | Temperature °C | Time (approx.) | Food | Pre-heat | Temperature °C | Time (approx.) | Position from Base of Oven |
| | | | | | | | | |
| Scones | Yes | 210/220 | 9-12 mins | Scones | Yes | 210/220 | 10-15 mins | Shelf 1 |
| Small Cakes | No | 170/180 | 15-25 mins | Small Cakes | Yes | 180/190 | 20-25 mins | Shelf 1 |
| Victoria Sandwich | No | 160/170 | 20-25 mins | Victoria Sandwich | Yes | 170/180 | 20-30 mins | Shelf 1 |
| Sponge Sandwich (fatless) | Yes | 170/190 | 15-20 mins | Sponge Sandwich (fatless) | Yes | 180/190 | 20-25 mins | Shelf 1 |
| Swiss Roll | Yes | 180/200 | 12-15 mins | Swiss Roll | Yes | 200/210 | 10-15 mins | Shelf 1 |
| Semi-rich Fruit Cake | No | 140/150 | 1 ¼ - 1 ½ hours | Semi-rich Fruit Cake | Yes | 150/160 | 7 inch 65-70 mins | Shelf 1 |
| Rich Fruit Cakes | No | 130/140 | Depending on use | Rich Fruit Cakes | Yes | 140/150 | Depending on size | Shelf 1 |
| Shortcrust Pastry | No | 190/200 | Depending on use | Shortcrust Pastry | Yes | 190/200 | Depending on recipe | Shelf 1 |
| Puff Pastry | No | 190/200 | Depending in use | Puff Pastry | Yes | 200/210 | Depending on recipe | Shelf 1 |
| Yorkshire Pudding | Yes | 180/190 | 40-45 mins | Yorkshire Pudding | Yes | 190/200 | 30-40 mins | Shelf 2 |
| Individual Yorkshire Pudding | Yes | 190/200 | 20-45 mins | Individual Yorkshire Pudding | Yes | 200/210 | 20-30 mins | Shelf 2 |
| Milk Pudding | No | 130/140 | 1 ½ - 2 hours | Milk Pudding | Yes | 140/150 | 1 ½ - 2 hours | Shelf 2 |
| Baked Custard | No | 140/150 | 35-45 mins | Baked Custard | Yes | 150/160 | 40-50 mins | Shelf 1 |
| Bread | Yes | 200/210 | 20-30 mins | Bread | Yes | 200/210 | 30-45 mins | Shelf 1 |
| Meringues | No | 70/90 | 3 - 4 hours | Meringues | Yes | 100 | 2 ½ - 3 hours | Shelf 2 |

Note: If soft tub margarine is being used for cake making, we would recommend using the all in one method and to reduce the temperature by 10 °C. Temperatures recommended in this chart refer to cakes made with block margarine or butter only.

Cooking Results Not Satisfactory

GRILL

Uneven cooking front to back

Ensure that the grill pan is positioned centrally below the grill element.

Fat splattering

Ensure that the grill pan is not lined with foil.
Ensure that the grill setting control (A) is not set too high.
If Solarplus grill – use anti-splash tray supplied under the food support.

BAKING GENERAL

Uneven rising of cakes

Ensure that the oven shelves are level.

Sinking of cakes

The following may cause cakes to sink:

1. Pre-heating of fan ovens – not always necessary.
2. Cooking at too high a temperature – reduce standard temperatures by 25°C for fan ovens.
3. Using normal creaming method with a soft margarine.
If using soft margarine, use an all in one method instead of the traditional creaming of the margarine and sugar.
Remember when using a food mixer or processor not to over-cream soft margarine.

Over/undercooking

Refer to the cooking times and temperatures given in the Oven Temperature Charts provided, however, it may be necessary to increase or decrease temperatures by 10°C to suit personal taste.

Do not use utensils greater than 56mm (2¼") in height for roasting.

TOP OVEN BAKING

Uneven cooking front to back

Ensure that the cooking utensil is at least 100mm (4") from the front of the shelf.

Uneven rising

Ensure that the shelf is level (as above) and that the food is positioned correctly in the oven.

Overcooking

Remember to reduce cooking temperatures by 10°C from standard recipes when using the top oven.

Food is taking too long to cook

Ensure that the cooking utensil used in the top oven is not larger than 300mm x 225mm (12"x 9"), e.g. **Do Not** use the main oven meat pan.

Only cook one item at a time to avoid overloading the oven.

Care and Cleaning

Warning: Before cleaning, please ensure that the electricity supply to the appliance is switched off and the appliance is fully cold.

1. "CREDACLEAN" OVEN LINERS

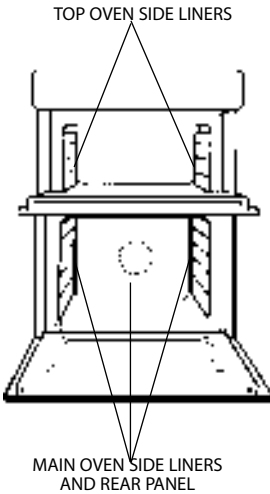

(a) How "Credaclean" works.

The surfaces of the "Credaclean" oven liners are treated with a special vitreous enamel which absorbs cooking soils. At temperatures of 220°C (425°F) or above, the special surface enables these soils to be slowly destroyed. The higher the temperature the more effective it is.

(b) Cleaning.

In most cases normal cooking operations at 220°C (425°F) will permit this cleaning operation to proceed during cooking. However if higher cooking temperatures are not used regularly, it may be necessary, in order to prevent heavy soiling, to run the ovens without shelves or meat pan, at a maximum setting for a couple of hours.

It should not normally be necessary to clean the "Credaclean" panels with water. If the user feels it is desirable to do so, wipe them over with a clean, soapy cloth, followed by a wipe with a clean damp cloth.

DO NOT use biological washing powder, harsh abrasives or chemical oven cleaners of any kind as this could damage the "Credaclean" oven liners.

Care and Cleaning

2. CLEANING GRILL, TOP OVEN AND MAIN OVEN

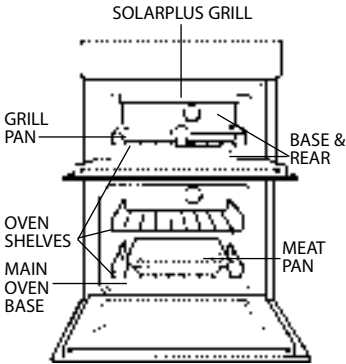

(a) Base & Rear of Top Oven and Base of Main Oven.

Wipe out the oven with a damp soapy cloth. For more stubborn stains on the base of the oven use a well soaped fine steel wool soap pad.

(b) Grill Pan, Meat Pans & Oven Shelves.

To prevent stains from being burnt on to the grill pan, food support and rod shelf, always wash immediately after use in warm soapy water.

Use a well soaped fine steel wool soap pad to remove stubborn stains from the rod shelves, grill pan, meat pan and the base of the oven.

DO NOT use aerosol cleaners on this oven as they could adversely affect the fan motor unit, and cannot be wiped off the fan blade.

(c) Solarplus Grill

To clean the Solarplus grill, use a clean, damp, soapy cloth and wipe over. If stubborn stains remain, gently clean with a well soaped nylon scouring pad and wipe over with a damp cloth.

DO NOT use metal cleaning utensils, wire wool or proprietary oven cleaners on the grill element mesh.

Care and Cleaning

3. OVEN DOORS

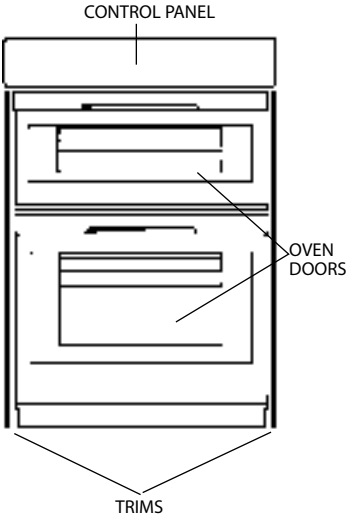

(a) Control Panel

Regularly wipe with a clean, damp cloth and polish with a clean, dry cloth.

(b) Trims

It is advisable to clean the trims regularly to prevent any build up of soiling which may detract from the appearance of the cooker. The recommended method of cleaning is to wipe over the trims with a clean, soft cloth wrung out in warm water, or mild non abrasive cleaner. (If in doubt try the cleaner on a small area of trim which is not noticeable in normal use), then after wiping with a cloth wrung out in clear water, dry with a clean, soft cloth.

(c) Inner Door Panels & Glass

Open the door fully. The glass panel may now be washed. Stubborn stains can be removed by using a well soaped, fine steel wool soap pad.

DO NOT use scouring pads, or abrasive powder, which will scratch the glass.

4. REPLACEMENT OF THE OVEN LAMP

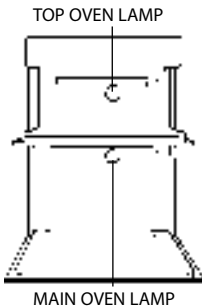

Warning: To avoid electric shocks - please ensure that the electricity supply to the appliance is switched off and the appliance is fully cold, before removing lamp lens.

Open the oven door and remove the oven shelves. Using a thick cloth, grip the lamp lens, unscrew anti-clockwise and remove the lens. Carefully unscrew the bulb anti-clockwise. Fit replacement bulb (15W 300°C SES). Fit replacement bulb and refit lens.

5. HOW TO CLEAN THE LAMP LENS

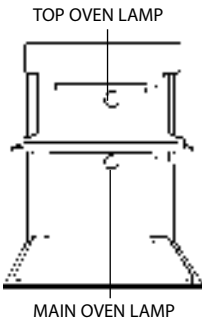

Warning: To avoid electric shocks - please ensure that the electricity supply to the appliance is switched off and the appliance is fully cold, before removing lamp lens.

Open the oven door and remove the oven shelves. Using a thick cloth, grip the lamp lens, unscrew anti-clockwise and remove. Clean with a non-abrasive cleansing cream and refit lamp lens.

DO NOT use scouring pads, or abrasive powder, which will scratch the glass lens

Care and Cleaning

TO CLEAN THE INSIDE OF OUTER AND INNER GLASS PANELS

Warning: Always switch your appliance OFF at the mains supply and allow to cool before cleaning.

Fig. 1

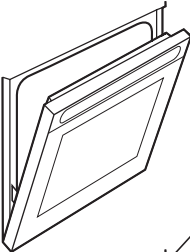

1. Position top or main oven door as shown in fig. 1.

Note: The door can be wedged open using a towel between the door and the side trim thus leaving your hands free.

Fig. 2

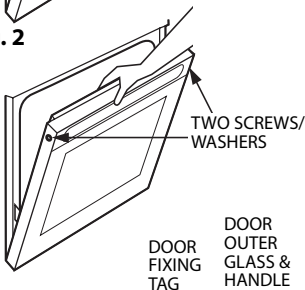

2. Grip inner door panel and handle/outer glass assembly. Remove two screws and fibre washers (put to one side) as shown in fig. 2.
3. Pull handle/outer glass assembly at the top outwards while still holding the inner door panel and unhook handle/outer glass assembly at the bottom by lifting handle/outer glass assembly upwards as shown in fig. 3. Take care not to dislodge rubber grommets in bottom of door.
4. Return the inner door panel to the closed position as shown in fig. 4.

Fig. 3

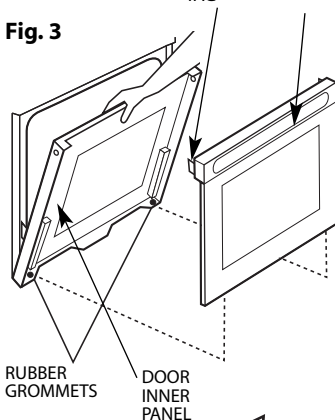

Warning: Care must be taken when closing the door inner panel as the door will attempt to snatch shut, without the weight of the handle/outer glass assembly avoid trapping your fingers.

5. The inside of inner and outer door glass can now be cleaned using a clean, damp cloth and polished using a clean, dry cloth.
6. Refit the handle/outer glass assembly by opening the oven door and hold taking care not to trap your fingers, see fig. 3. Hook the handle/outer glass assembly back into the rubber grommets at the bottom of the inner door panel, see fig. 3. Fit the handle/outer glass assembly back in position at the top ensuring the fixing tags on the handle/outer glass assembly fit inside the door inner panel. While still holding door together, refit the two screws and washers, see fig. 2.

Fig. 4

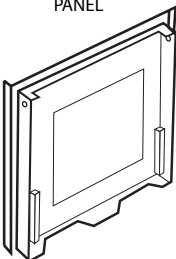

Never operate the ovens without the outer glass panels correctly refitted.

Installation

Electrical Requirements

For your own safety, we recommend that your cooker is installed by a competent person such as one who is registered with NICEIC (National Inspection Council for Electrical Installation Contracting). The cooker should be installed in accordance with the latest edition of the IEE Regulations.

Warning: This appliance must be earthed.

Electrical Connections

The installer must check that the voltage shown at the rating plate corresponds with the house electricity supply.

The cooker must be supplied via a suitable double pole isolating switch, having a contact separation of at least 3mm in all poles placed in a readily accessible position adjacent to the cooker.

If the cooker is to be wired into a connector unit, this may be positioned behind the cooker providing the following requirements are met:

- i) The connector unit must not project from the wall more than 25mm.
- ii) The top of the connector must not be more than 130mm above floor level.

Remove the terminal cover at the rear base of the cooker. Pass the cable through the cable clamp and connect to the appropriate terminals provided.

Allow sufficient cable for any future servicing.

Tighten the screws on the cable clamp and replace the cover.

Make main connections in the connector unit or cooker control unit.

This appliance conforms to B.S. EN 55014 regarding suppression of Radio and Television reception interference.

A double Pole control switch having a minimum rating of 32 amps should be used to feed the cooker using a suitably rated cable.

Where a hob is fitted adjacent to or over the cooker, a 45 amp Double Pole control switch should be used to feed both units via separate suitably rated cables.

We recommend a minimum of 4mm² PVC insulated twin and earth cable conforming to B.S. 6004 for connection of each appliance.

Where a hob is fitted above the cooker the cable connecting the hob to the cooker control unit must be of 2.5mm² 85°C heat resistant cable to BS6141 table 15

In all cases adhere to routing details (see fig. 5).

This appliance must not be installed over any other appliance that generates heat such as a plinth heater

Note: Due to many different types of installation, a mains cable is not supplied with this product. The installer will fit the correct type and length of cable.

Installation

1. General

The appliance is designed to be mounted on a floor between two adjacent cabinets. The cabinets must be securely fixed to the wall and the cooker securely fixed to the cabinets. This cooker must not be used free standing.

Note: This appliance must NOT be fitted on a platform.

3. Final Installation

- a. Ensure that the adjacent cabinets and the gap between them have dimensions in accordance with the diagram.
- b. Assemble the plastic plugs provided into the fixing brackets. See diagram.
- c. Fix the fixing brackets to the sides of the adjacent cabinets so that the centre line of the brackets are 565mm above the top of the plinth line and the front face of the plastic plug is level with the front face of the cabinet sides. See diagram.
- d. Adjust the feet on the cooker to their minimum position, i.e. fully screwed in.
- e. Slide the cooker centrally into the space between the cabinets ensuring the following:
 - i) The gap between the cabinet sides and the cooker is even along the length of the cabinet sides.
 - ii) The cable is routed away from any vents in the rear panel and is not trapped between the cooker and the wall, adjacent cabinets or under the feet
- f. Adjust the feet using an open ended spanner until the bottom of the cooker door is in line with the top of the plinth. Using a spirit level, check that the cooker is level in all directions.
- g. Check that the plinth can be fitted. If necessary re - adjust the feet and check that the cooker is level.
- h. Open the top oven door and fix the cooker to the brackets through the holes in the side trims.
- i. Fix the plinth in position.
- j. Ensure that there is a minimum gap of 1mm between the cooker side trim and the adjacent cabinet doors or drawer fronts.
- k. If a hob is to be installed directly above the cooker it must not project downwards more than 20mm below the underside of the work top. Any projection of more than 10mm must not project more than 500mm from the wall.

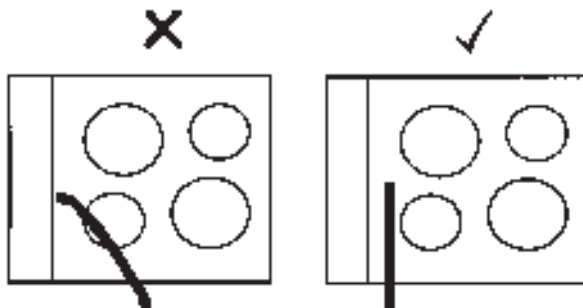
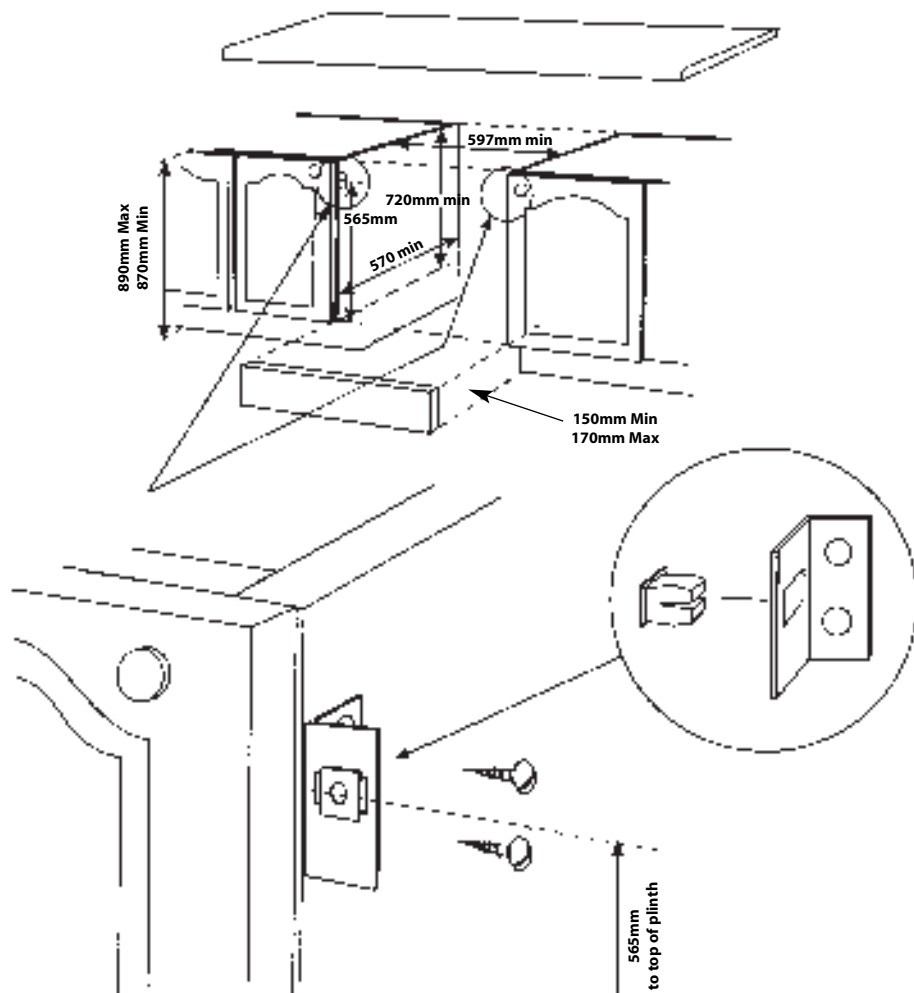

Fig. 5

Installation



A minimum distance of 25mm should be maintained between the front face of the cabinet side and the front face of the plinth.

Installation

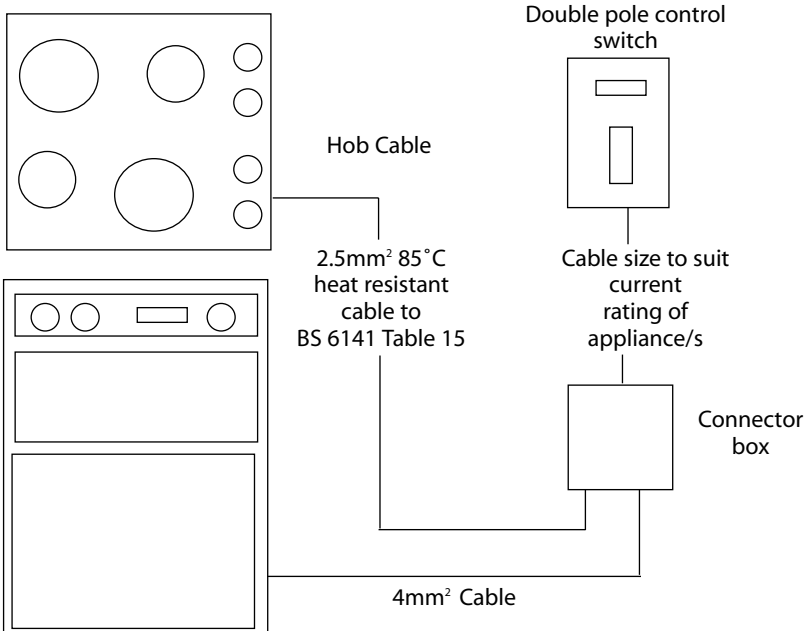
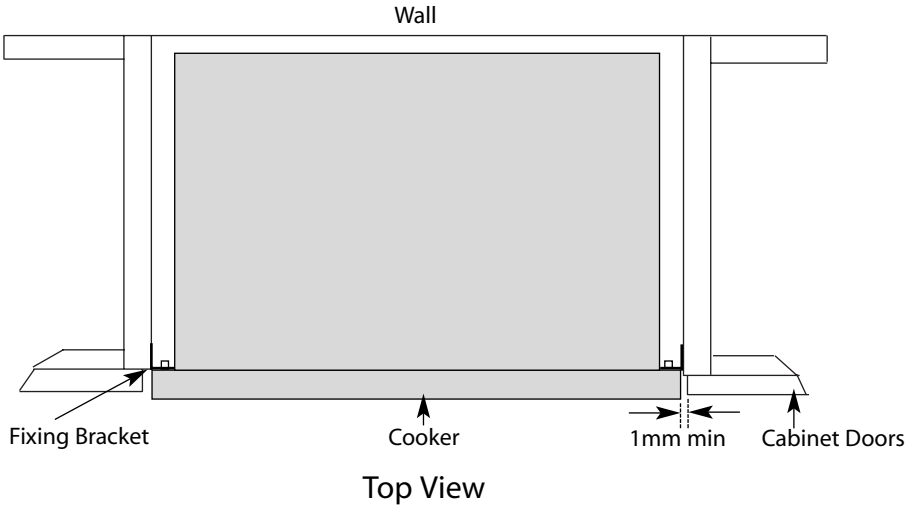

Something Wrong?

**Before calling a Service Engineer, please check through the following lists.
THERE MAY BE NOTHING WRONG.**

| Problem | Check |
|--|--|
| Slight odour or small amount of smoke when grill / oven is used for the first time, | This is normal and should cease after a short period. |
| Nothing works. | (a) Check If you find :- Display is blank. Then it is likely that there is no electricity supply to your oven. Check: (i) That the main cooker wall switch is turned on. (ii) Check other appliances to see if you have a power cut. (iii) Check the main circuit breaker for the property. |
| Display shows 0.00 AUTO. | The power supply to your oven has possibly been interrupted, but has now come back on again. Reset the timer to the correct time of day and "Manual" operation using instructions given in the timer section of the book. |
| Main Oven does not work, but the Grill and Top Oven work. | Check the following to ensure that the timer is in Manual Mode: Check that the Auto Symbol is <u>not</u> lit up and is not flashing. See timer section for instructions on how to return timer to "Manual". |
| Top Oven and Grill do not work, but the Main Oven works. | Operating the cooker under the following conditions may cause a safety device to operate. (a) Grilling with the door closed - always grill with the door open to the correct position - see grilling. (b) Grilling for an excessively long period at maximum setting - see grilling guide. (c) Grilling with inadequate ventilation in the cabinet - see installation instructions. |
| Grill does not work. | Check that you have selected :- "Grill" function on the "Top/Oven Grill Select" knob (B) and a Grill setting on the "Grill" knob (A) - see grilling page. |
| Grill keeps turning on and off. | When the "Grill" control (A) is operating at less than "6", the grill will cycle on and off, this is normal and is <u>not</u> a fault. |
| Can not set an "Auto Cook" programme | Remember: "Cook Period" is the actual length of time for which, the timer will switch the oven(s) on as part of an "Auto Cooking" programme. |
| Draught from beneath control panel. | A gentle flow of air will be blown from beneath the control panel when the appliance is used. If the appliance is still warm, this cooling fan may run on, or restart itself after all of the controls have been turned off. The fan will stop once the appliance has been cooled. This is normal and not a fault. |
| Timer buzzer/bleeper operates continually | Press the minute minder button to silence the Buzzer/Bleeper. |

If you have been through the above list and there is still a problem; You should identify your Service Agent using the list on the back page and contact your Local Service Office.

Key Contacts

Service

Creda has the largest appliance manufacturer's service team in Europe, trained specialists directly employed by us to ensure your complete confidence.

Repair Service

UK: 08709 066 066

Republic of Ireland: 1850 302 200

You will be asked for the following information:-

Name, address and postcode.

Telephone number

Model / Serial number of the appliance

Clear and concise details of the query or fault

Place and Date of purchase

(Please keep the receipt as evidence will be required when the engineer calls).

Extended Warranty

To join: UK 08709 088 088

Republic of Ireland: 1850 502 200

Genuine Parts & Accessories

Mail Order Hotline

UK: 08709 077 077

Republic of Ireland: (01) 842 6836

For further product information 08701 546474

All Creda Services are offered as an extra benefit and do not affect your statutory rights.



General Domestic Appliances Limited, Morley Way, Peterborough, PE2 9JB