

# **SYS7180VE**

PICMG Single Board Computer

For socket 478 CPU With VGA/ LAN

(Pentium 4™&Celeron™& Intel® Celeron®D™ CPU)

## **User's Manual**

## Copyright

This document is copyrighted, © 2004. All rights are reserved. The original manufacturer reserves the right to make improvements to the products described in this manual at any time without notice.

No part of this manual may be reproduced, copied, translated or transmitted in any form or by any means without the prior written permission of the original manufacturer. Information provided in this manual is intended to be accurate and reliable. However, the original manufacturer assumes no responsibility for its use, nor for any infringements upon the rights of third parties that may result from such use.

## Acknowledgments

IBM/AT and PS/2 are trademarks of International Business Machines Corporation.

Award is a registered trademark of Award Software International, Inc.

Intel®, Celeron™, Pentium 4™ and Pentium 4™ are registered trademarks of Intel Corporation.

Microsoft Windows is a registered trademark of Microsoft Corporation.

All Other product names or trademarks are properties of their respective owners.

## Liability

The obligation of the warrantor is solely to repair or replace the product. In no event will the warrantor be liable for any incidental or consequential damages due to such defect or consequences that arise from inexperienced usage, misuse, or malfunction of this device.

## Additional Information and Assistance

1. The manufacturer recommends using a grounded plug to ensure proper motherboard operation. Care should be used in proper conjunction with a grounded power receptacle to avoid possible electrical shock. All integrated circuits on this motherboard are sensitive to static electricity. To avoid damaging components from electrostatic discharge, please do not remove the board from the anti-static packing before discharging any static electricity to your body, by wearing a wrist-grounding strap. The manufacturer is not responsible for any damage to the motherboard due to improper operation.
2. Visit the Grantech web site at [www.grantech.com.tw](http://www.grantech.com.tw) where you can find the latest information about the product.
3. Contact your distributor, sales representative, or Grantech's customer service center for technical support if you need additional assistance. Please have the following information ready before you call:
  - Product name and serial number
  - Description of your peripheral attachments
  - Description of your software (operating system, version, application, etc.)
  - A complete description of the problem
  - The exact wording of any error messages

# Table of Contents

<b>CHAPTER 1 INTRODUCTION .....</b>	<b>1</b>
1.1 SPECIFICATION .....	1
1.2 CHECK LIST .....	1
1.3 DESCRIPTION .....	2
1.4 POWER REQUIREMENTS .....	2
1.5 CONNECTOR & JUMPER LOCATION .....	4
1.6 BLOCK DIAGRAM.....	5
<b>CHAPTER 2 HARDWARE INSTALLATIONS .....</b>	<b>6</b>
2.1 INSTALLATION PROCEDURE .....	6
2.2 CPU INSTALLATION:.....	7
2.3 MAIN MEMORY INSTALLATION: DIMM1/2.....	8
2.4 JUMPER SETTINGS:.....	10
2.5 CONNECTORS SETTING: .....	12
2.5.1 FRONT PANEL CONNECTOR: J1 .....	13
2.5.2 USB CONNECTOR: USB1-2 USB3-4 .....	14
2.5.3 PARALLEL PORT CONNECTOR: LPT .....	15
2.5.4 SERIAL PORT CONNECTOR: COM1/COM2.....	16
2.5.5 IDE PORT CONNECTOR: IDE1/ IDE2.....	16
2.5.6 FLOPPY DISK CONNECTOR: FLOPPY .....	17
2.5.7 ADAPTER CONNECTOR FOR 10/100 LAN: LAN1 .....	18
2.5.8 ADAPTER CONNECTOR FOR GIGA LAN: LAN2 .....	19
2.5.9 EXTERNAL KEYBOARD/MOUSE CONNECTOR:.....	20

2.5.10 VGA CONNECTOR: .....	21
2.5.11 KEYBOARD / MOUSE CONNECTOR:.....	21
2.5.12 CPU FAN CONNECTOR: .....	21
2.5.13 ACPI CONNECTOR: J2.....	22
<b>CHAPTER 3 BIOS SETUP .....</b>	<b>24</b>
3.1 INTRODUCTION .....	24
3.2 MAIN MENU .....	26
3.3 STANDARD CMOS SETUP.....	28
3.4 ADVANCED BIOS FEATURES SETUP.....	30
3.5 ADVANCED CHIPSET FEATURES SETUP .....	34
3.6 INTEGRATED PERIPHERALS .....	38
3.7 POWER MANAGEMENT SETUP.....	43
3.8 PNP/PCI CONFIGURATION SETUP .....	49
3.9 PC HEALTH STATUS .....	51
3.10 DEFAULTS MENU .....	51
3.11 SUPERVISOR/USER PASSWORD SETTING .....	52
3.12 EXIT SELECTING .....	52
3.13 POST MESSAGES .....	53
3.14 POST BEEP .....	53
3.15 ERROR MESSAGES .....	53
<b>Appendix.....</b>	<b>59</b>

## Chapter 1 Introduction

### 1.1 Specification

Processor	Support Intel® Pentium™ 4 CPU up to 3.06 GHz Support Intel® Celeron™ CPU up to 2.60 GHz Support Intel® Celeron®D™ CPU up to 2.80 GHz (Prescott core)
Chipset	Intel®82845GV chipset supports 400/533MHz FSB
Memory	Two 184-pin DDR DIMMs socket, up to 2GB of 266/333MHz DDR SDRAM
BIOS	Award 4Mbit PnP flash BIOS
VGA	Integrated in 845GV, AGP4X Share memory up to 64MB with system main-memory
LAN	LAN1: Intel® 82562ET Ethernet controller, supports 10/100M Base-T LAN2: (optional)Intel®82540EM Ethernet controller, supports 10/100/1000 Base-T Wake On LAN support
USB	Four USB ports, Hi-speed USB 2.0
Super I/O	Mini-DIN: 1x PS/2 keyboard/mouse connector RJ-45: 10/100/1000Mb Ethernet connector Female DB-15: VGA connector Box-header: 2* Serial port (2x5Pin); 1*FDD (2x17Pin); 2* EIDE (2x20Pin); Pin-header: 1*Parallel port (2x13Pin)
Watchdog	System reset or non- maskable interrupt software programmable time I interval and jumper selectable (64-level)
Operating temperature	0°C ~60°C
Relative humidity	10% ~90% non-condensing at temperature of 40BC or 104BF

### 1.2 Check List

Please check that your package is complete and contains the items below. If you discover damaged or missing items, please contact your dealer.

- SYS7180VE CPU card
- Utility CD for SYS7180VE
- Installation Guide
- IDE cable \*2
- FDD cable \*1

- PS/2 1 to 2 adapter \*1
- Com extension cables with bracket \*1
- Com, Printer extension cables with bracket \*1
- +12V power cable \*1
- USB cable \*1 ( Special for SYS7180VE )
- Jumper Short Pin: 6 pcs

### 1.3 Description

The SYS7180VE is a motherboard based on Intel 845GV chipset and is fully designed for PC environment. It features socket 478 compatible with Intel's processor. This card accommodates up to 2GB of DDR memory.

The SYS7180VE comes with on board CPU temperature sensor to protect your processor from overheating (Winbond W83627HF chipset). Wired for Management (WFM) 2.0 specification compliance.

The SYS7180VE has a LAN connector that uses Intel ICH4 integrated with Intel 82562ET (AOL & 10/100) controller.

### 1.4 Power Requirements

Your system requires a clean, steady power source for reliable performance of the high frequency CPU on the SYS7180VE Industrial CPU card, the quality of the power supply is even more important. For the best performance makes sure your power supply provides a range of 4.75 volts minimum to 5.25 volts maximum DC power source.

#### *Power Consumption*

For typical configurations, the CPU card is designed to operate with at least a 200W power supply. A higher-wattage power supply should be used for heavily-loaded configurations. The power supply must meet the following requirements:

- Rise time for power supply: 2 ms to 20 ms
- Minimum delay for reset to Power Good: 100 ms
- Minimum Power down warning: 1 ms

- 3.3 V output must reach its minimum regulation level within 20ms of the +5V output reaching its minimum regulation level

The following table lists the power supply’s tolerances for DC voltages:

DC Voltage	Acceptable Tolerance
+3.3 V	± 5 %
+5 V	± 5 %
+5 VSB (standby)	± 5 %
-5 V	± 5 %
+12 V	± 5 %
-12 V	± 5 %

## 1.5 Connector & Jumper Location

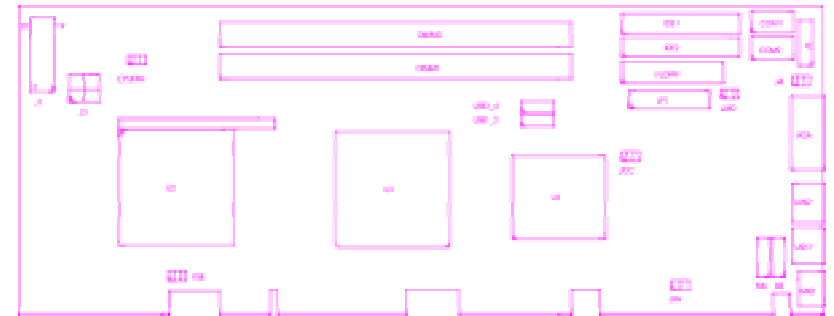

## 1.6 Block Diagram

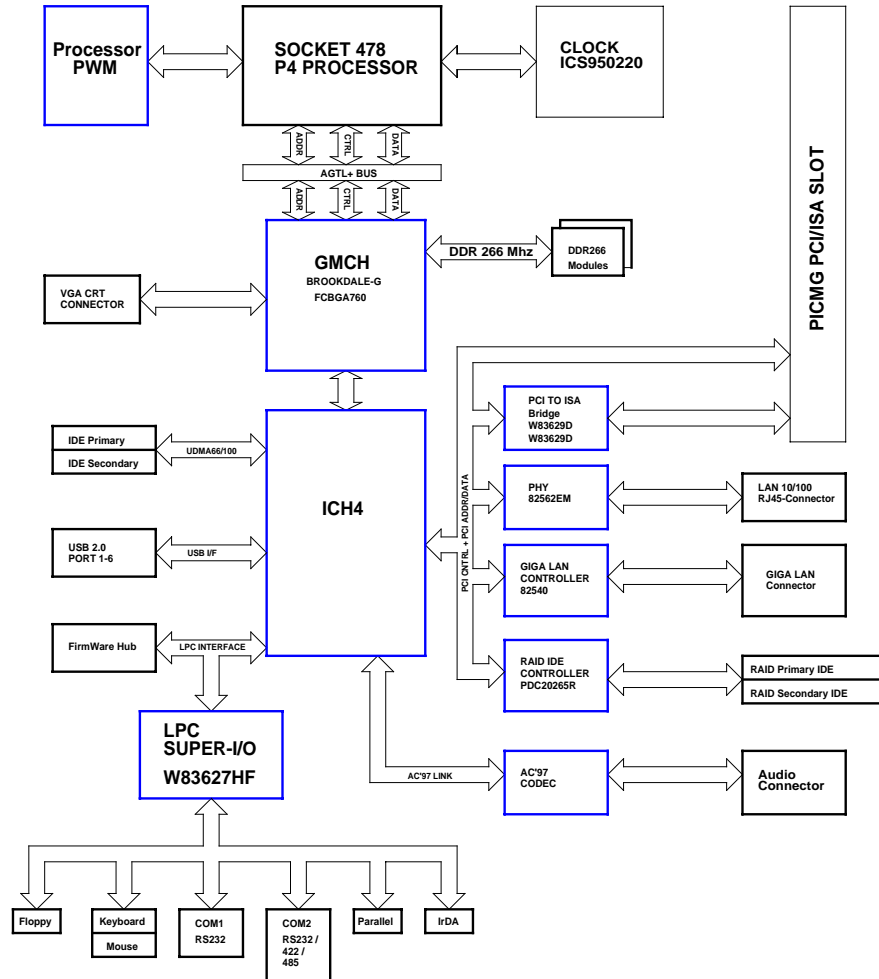

## Chapter 2 Hardware Installations

This chapter provides information on how to use the jumpers and connectors on the SYS7180VE in order to set up a workable system.

### 2.1 Installation procedure

- 2.1.1 Insert the system BIOS (if not already installed) gently. Pay attention to the position of pin 1 of BIOS socket.
- 2.1.2 Install the processor with correct orientation.
- 2.1.3 Insert the DRAM module with correct orientation.
- 2.1.4 Mount the Fan on the top of the processor and connect it to FAN connector.
- 2.1.5 Insert all external cables except for flat panel. (Hard disk, floppy, keyboard, Mouse, LAN, etc.)
- 2.1.6 Prepare a CRT monitor for CMOS setup.
- 2.1.7 Confirm the power supply is off.
- 2.1.8 Turn on the power.

*Note: The CMOS memory may be in an undefined state at power-on after a period of no battery backup.*

## 2.2 CPU Installation:

The SYS7180VE Industrial CPU Card supports a single **Intel® P4 Celeron™ or Celeron D™ processor and Pentium 4™ processor**. The processor's VID pins automatically program the voltage regulator on the CPU card to the required processor voltage. The host bus speed is automatically selected. The processor connects to the CPU card through the 478-pins socket.

The CPU card supports the processors listed in table below:

P4 Celeron™ processor	
Host Bus frequency	Cache size
400MHz	128KB
Pentium 4™ processor	
Host Bus frequency	Cache size
400MHz / 533MHz	512KB
Celeron D™ processor	
Host Bus frequency	Cache size
533MHz	256KB or 1M

The socket-478 comes with a lever to secure the processor. Make sure the notch on the corner of the CPU corresponds with the notch on the inside of the socket.

After you have installed the processor into the socket 478, check if the configuration setup for the CPU type and speed are correct. The CPU should always have a Heat Sink and a cooling fan attached to prevent overheating.

**Note:** Ensure that the CPU heat sink and the CPU top surface are in total contact to avoid CPU overheating problem that would cause your system to hang or be unstable.

## 2.3 Main Memory Installation: DIMM1/2

The SYS7180VE Industrial CPU Card supports two single-side or double-sided DDR266/333 unregistered, DIMM 184-pin sockets for a maximum total memory of 1GB. Using the non-ECC DDR SDRAM DIMMS.

The CPU card supports the following memory features:

- 184-pin DIMMs with gold-plated contacts
- 266MHz and 333MHz non-ECC DDR SDRAM
- Un-buffered single or double-sided DIMMs in the following sizes:

### SDRAM

SYNCHRONOUS DRAM (SDRAM) improves memory performance through memory access that is synchronous with the memory clock. Burst transfer rates at x-1-1-1 timing can be achieved using SDRAM, while asynchronous memory subsystems are typically limited at x-2-2-2 transfer rates.

The CPU card supports single or double-sided DIMMs in the following sizes:

DIMM size	Non-ECC configuration
16MB	2Mbit x 64
32MB	4Mbit x 64
64MB	8Mbit x 64
128MB	16Mbit x 64
256MB	32Mbit x 64

**Note:** All memory components and DIMMs used with the SYS7180VE CPU card must comply with the PC SDRAM Specification. These include: the PC SDRAM Specification \*memory component specific), the PC Unbuffered DIMM Specification, and the PC Serial Presence Detect Specification.

**Chipset****Intel 82845GV GMCH overview**

The features:

- 400/533 MHz PSB (100/133MHz bus clock)
- 32-bit addressing for access to 2GB of memory space up to 2GB of 266MHz or 333 MHz DDR SDRAM.
- Supports only for un-buffered non-ECC DIMMs.
- Hub Interface:
  - Supports Hub Interface 1.5
  - 266MB/s point-to-point Hub Interface to the ICH4.
  - 1.5V operation.
- AGP Interface
  - Supports a single 1.5V AGP 2.0 compliant device.
- Integrated Graphics
  - 3D Setup and Render Engine.
  - 2D Graphics.
- Analog Display Support
- Digital Display Channels

**2.4 Jumper Settings:**

Jumper	Default setting	Jumper setting
FSB	FSB setting: auto	Short 1-2
JCC	Clear CMOS : Normal mode	Short 2-3
JAV	BIOS write-protect: disabled	Open
J4	AT or ATX select: AT	Short 1-2

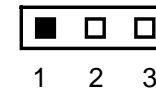
**2.4.1 FSB Setting:**

Options	Setting
400	Short 2-3
533	Open
Auto (default)	Short 1-2

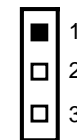
**2.4.2 Clear CMOS Setting: JCC**

JCC

Options	Settings
Normal	Short 2-3 (default)
Clear CMOS	Short 1-2

**2.4.3 BIOS Write-protect Setting : JAV**

JAV

Options	Settings
Disable	Open (default)
Enable	Short 1-2



## 2.4.4 AT/ATX Power Setting : J4

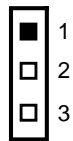

Options	Settings
AT	Short 1-2 (default)
ATX	Short 2-3

J4

## 2.4.5 Watchdog Setting: JWD

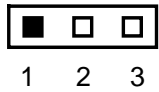

Options	Setting
IRQ11	Short 1-2
Reset	Short 2-3 (default)
Disabled	Open

## 2.5 Connectors Setting:

Connectors	Label	Connectors	Label
Primary IDE Connector	IDE1	ACPI Connector	J2
Secondary IDE Connector	IDE2	VGA Connector	VGA
FDD Connector	FLOPPY	PS/2 Mouse Connector	MS
Printer Port Connector	LPT	PS/2 Keyboard Connector	KB
USB 1_2 Connector	USB1_2	Keyboard/Mouse Connector	MKB
USB 3_4 Connector	USB3_4	CPU Fan Connector	CPUFAN
DDR1 184P Connector	DIMM1	DDR2 184P Connector	DIMM2
COM1 Connector	COM1	COM2 Connector	COM2
Ethernet 1 RJ-45 Connector	LAN1	Ethernet 2 RJ-45 Connector	LAN2
Flat Panel Connector	J1	ATX +12V Power Connector	J3

## 2.5.1 Front Panel Connector: J1

This header can be connected to a front panel power switch. The front panel connector includes headers for these I/O connections:

### ***Power switch***

#### **Power LED**

This header can be connected to an LED that will light when the computer is powered on.

### ***Hard drive activity LED***

This header can be connected to an LED to provide a visual indicator that data is being read from or written to an IDE hard drive. For the LED to function properly, the IDE drive must be connected to the onboard IDE controller.

### ***Speaker***

A speaker can be installed on the SYS7180VE as a manufacturing option. The speaker is enabled by a jumper on pins 2, 4, 6, 8 of the front panel connector. Removing the jumper can disable the onboard speaker, and an offboard speaker can be connected in its place. The speaker (onboard or offboard) provides error beep code information during the POST in the event that the computer cannot use the video interface. The speaker is not connected to the audio subsystem and does not receive output from the audio subsystem.

19	17	15	13	11	9	7	5	3	1
20	18	16	14	12	10	8	6	4	2

**1-3-5: POWER LED    2-4-6-8: SPEAKER    7-9: KEYLOCK**  
**13-14: POWER ON    15-16: GREEN LED    17-18: RESET**  
**19-20: IDE LED**

**PIN1— POWER LED+    PIN5—POWER LED-**  
**PIN15—GREEN LED+    PIN16—GREEN LED-**  
**PIN19—IDE LED-    PIN20—IDE LED+**

## 2.5.2 USB Connector: USB1-2 USB3-4

**Note:** USB cable is special designed for SYS7180VE

The Universal Serial Bus (USB) that allows plug and play computer peripherals such as keyboard, mouse, joystick, scanner, printer, modem/ISDN, CD-ROM and floppy disk drive to be automatically detected when they are attached physically without having to install drivers or reboot.

The USB connectors allow any of several USB devices to be attached to the computer. Typically, the device driver for USB devices is managed by the operating system. However, because keyboard and mouse support may be needed in the Setup program before the operating system boots, the BIOS supports USB keyboards and mice.

The CPU card has four USB ports; one USB peripheral can be connected to each port. For more than four USB devices, an external hub can be connected to either port. The four USB ports are implemented with stacked back panel connectors. The CPU card fully supports the universal host controller interface (UHCI) and uses UHCI-compatible software drivers.

USB features includes:

- Self-identifying peripherals that can be plugged in while the computer is running
- Automatic mapping of function to driver and configuration
- Support for synchronous and asynchronous transfer types over the same set of wires
- Support for up to 127 physical devices
- Guaranteed bandwidth and low latencies appropriate for telephony, audio and other applications
- Error-handling and fault-recovery mechanisms built into the protocol

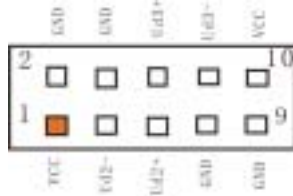

### 2.5.3 Parallel Port Connector: LPT

The parallel port bracket can be used to add an additional parallel port for additional parallel devices. There are four options for parallel port operation:

- Compatible (Standard mode)
- Bi-Directional (PS/2 compatible)
- Bi-Directional EPP. A driver from the peripheral manufacturer is required for operation.
- Bi-Directional High-speed ECP

Pin	Description	Pin	Description
1	Strobe#	14	Auto Form Feed#
2	Data 0	15	Error#
3	Data 1	16	Initialize#
4	Data 2	17	Printer Select In#
5	Data 3	18	GND
6	Data 4	19	GND
7	Data 5	20	GND
8	Data 6	21	GND
9	Data 7	22	GND
10	Acknowledge#	23	GND
11	Busy	24	GND
12	Paper Empty#	25	GND
13	Printer Select	26	

### 2.5.4 Serial Port connector: COM1/COM2

COM1, COM2 are used in the 10-pins box-header, are onboard serial ports of the CPU card SYS7180VE. The following table shows the pin assignments of these connectors.

COM1/2 Pin	Description
1	Data Carrier Detect (DCD)
2	Data Set Ready (DSR)
3	Receive Data (RXD)
4	Request to Send (RTS)
5	Transmit Data (TXD)
6	Clear to Send (CTS)
7	Data Terminal Ready (DTR)
8	Ring Indicator (RI)
9	Ground (GND)
10	GND

A diagram of a 10-pin connector. The pins are arranged in two rows of five. The top row is labeled from left to right: 9, 10, 1, 2. The bottom row is labeled from left to right: 9, 10, 1, 2. Pin 1 is highlighted in black.

COM1 / COM2

### 2.5.5 IDE port Connector: IDE1/ IDE2

The CPU card SYS7180VE provides a bus-mastering PCI IDE interfaces. These interfaces support PIO Mode 3, PIO Mode 4, ATAPI devices (e.g., CD-ROM), and Ultra DMA/33/66/100 synchronous-DMA mode transfers. The BIOS supports logical block addressing (LBA) and extended cylinder head sector (ECHS) translation modes. The BIOS automatically detects the IDE device transfer rate and translation mode.

Programmed I/O operations usually require a substantial amount of processor bandwidth. However, in multitasking operating systems, the bandwidth freed by bus mastering IDE can be devoted to other tasks while disk transfers are occurring.

These connectors support the provided IDE hard disk ribbon cable. After connecting the single end to the board, connect the two plugs at the other end to your hard disk(s). If you install two hard disks, you must configure the second drive to Slave mode by setting its jumper accordingly. Please refer to your hard disk documentation for the jumper setting.

Pin	Description	Pin	Description	Pin	Description
1	Reset #	2	GND	3	Data 7
4	Data 8	5	Data 6	6	Data 9
7	Data 5	8	Data 10	9	Data 4
10	Data 11	11	Data 3	12	Data 12
13	Data 2	14	Data 13	15	Data 1
16	Data 14	17	Data 0	18	Data 15
19	GND	20	No connector	21	No connector
22	GND	23	IOW #	24	GND
25	IOR #	26	GND	27	IOCHRDY
28	No connector	29	No connector	30	GND-Default
31	Interrupt	32	No connector	33	SA1
34	No connector	35	SA0	36	SA2
37	HDC CS0 #	38	HDC CSI #	39	HDD Active #
40	GND				

### 2.5.6 Floppy Disk Connector: FLOPPY

The floppy interface can be configured for the following floppy drive capacities and sizes:

- 360 KB, 5.25-inch
- 1.2 MB, 5.25-inch
- 720 KB, 3.5-inch
- 1.2 MB, 3.5-inch (driver required)
- 1.25/1.44 MB, 3.5-inch

- 2.88 MB, 3.5-inch

This connector supports the provided floppy drive ribbon cable. After connecting the single end to the board, connect the two plugs on the other end to the floppy drives.

Pin	Description	Pin	Description	Pin	Description
1	GND	2	Reduce write current	3	GND
4	No connector	5	GND	6	No connector
7	GND	8	Index#	9	GND
10	Motor enable A#	11	GND	12	Drive select B#
13	GND	14	Drive select A#	15	GND
16	Motor enable B#	17	GND	18	Direction#
19	GND	20	STEP#	21	GND
22	Write data#	23	GND	24	Write gate#
25	GND	26	Track 0 #	27	GND
28	Write protect#	29	GND	30	Read data#
31	GND	32	Side 1 select#	33	GND
34	Disk change#				

### 2.5.7 Adapter connector for 10/100 LAN: LAN1

This connector is for the LAN adapter that has LED indicate the 10/100Mbps transfer rate / Link / Act status of Ethernet capability of the CPU card. The follow table shows the pin assignments of this connector.

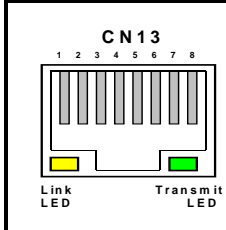
	PIN No.	Function	PIN No.	Function
	1	TX+	5	GND
2	TX-	6	NC	
3	NC	7	RX+	
4	GND	8	RX-	

## 2.5.8 Adapter connector for GIGA LAN: LAN2

This connector is for the GIGA LAN adapter that 10/100/1000 Base-TX RJ45 single port (1X1) tab-UP with LEDs integrated magnetics connector. The follow table shows the pin assignments of this connector.

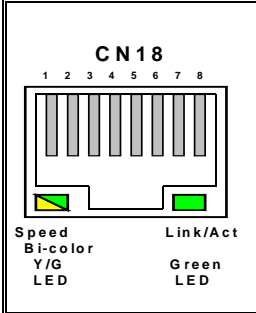
	PIN No.	Function	PIN No.	Function
		1	TCT3	9
	2	TD3-	10	TD4+
	3	TD3+	11	TD1+
	4	TD2+	12	TD1-
	5	TD2-	Left LED	10M / OFF
	6	TCT2		100M / G
	7	TCT4		1000M / Y
	8	TD4+	Right LED	Link / G
				Act / Blink

## 2.5.9 External Keyboard/Mouse Connector:

There are two 5-pin connectors for external keyboard&mouse.

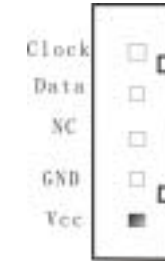

### 2.5.10 VGA Connector:

It is a VGA CRT connector. The pin assignments are as follows:

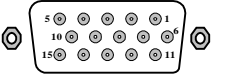
	PIN No.	Function	PIN No.	Function
	1	Red	2	Green
3	Blue	4	N.C	
5	GND	6	GND	
7	GND	8	GND	
9	VCC	10	GND	
11	N.C	12	DDC data	
13	H-Sync	14	V-Sync	
15	DDC clock	16	N.C	

### 2.5.11 Keyboard / Mouse Connector:

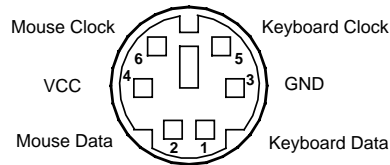

### 2.5.12 CPU FAN Connector:

FAN is a 3-pins box-header for the CPU cooling fan power connector. The fan must be a 12V fan. Pin 3 is for Fan speed sensor input. Pin 2 is for PWM regulating voltage output.

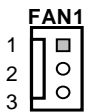

	PIN No.	Function	Connector type for Cable
	1	GND	Housing: 5102-03 (molex) Contact: 5103 (molex)
2	POWER		
3	FAN		

### 2.5.13 ACPI Connector: J2

When used with an ATX-compliant power supply that supports remote power on/off, the CPU card can turn off the system power through software control.

To enable soft-off control in software, advanced power management must be enabled in the Setup program and in the operation system. When the system BIOS receives the correct APM command from the operating system, the BIOS turns off power to the computer.

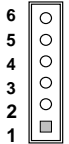
With soft off enabled, if power to the computer is interrupted by a power outage or a disconnected power cord, when power resumes, the computer returns to the power state it was in before power was interrupted (on or off).

J2	PIN No.	Function		
	1	5VSB		
	2	PS_ON		
	3	GND		
	4	PWRCTL		
	5	GND		
	6	SLEEPSW		
PW2	PIN No.	Function	PIN No.	Function
	4	+12V	2	GND
	3	+12V	1	GND

## Chapter 3 BIOS Setup

### 3.1 Introduction

This chapter discusses Award's Setup program built into the FLASH ROM BIOS. The Setup program allows users to modify the basic system configuration. This special information is then stored in battery-backed RAM so that it retains the Setup information when the power is turned off.

The rest of this chapter is intended to guide you through the process of configuring your system using Setup.

#### Starting Setup

The Award BIOS is immediately activated when you first power on the computer. The BIOS reads the system information contained in the CMOS and begins the process of checking out the system and configuring it. When it finishes, the BIOS will seek an operating system on one of the disks and then launch and turn control over to the operating system.

While the BIOS is in control, the Setup program can be activated in one of two ways:

1. By pressing <Del> immediately after switching the system on, or
2. by pressing the <Del> key when the following message appears briefly at the bottom of the screen during the POST (Power On Self-Test).

***Press DEL to enter SETUP.***

If the message disappears before you respond and you still wish to enter Setup, restart the system to try again by turning it OFF then ON or pressing the "RESET" button on the system case. You may also restart by simultaneously pressing <Ctrl>, <Alt>, and <Delete> keys. If you do not press the keys at the correct time and the system does not boot, an error message will be displayed and you will again be asked to...

***Press F1 to continue, DEL to enter SETUP***

#### Using Setup

In general, you use the arrow keys to highlight items, press <Enter> to select, use

the PageUp and PageDown keys to change entries, press <F1> for help and press <Esc> to quit. The following table provides more detail about how to navigate in the Setup program using the keyboard.

Key	Function
Up Arrow	Move to the previous item
Down Arrow	Move to the next item
Left Arrow	Move to the item on the left (menu bar)
Right Arrow	Move to the item on the right (menu bar)
Esc	Main Menu: Quit without saving changes Submenus: Exit Current page to the next higher level menu
Move Enter	Move to the item you desired
PgUp key	Increase the numeric value or make changes
PgDn key	Decrease the numeric value or make changes
+ key	Increase the numeric value or make changes
- key	Decrease the numeric value or make changes
Esc key	Main Menu -- Quit and not save changes into CMOS Status Page Setup Menu and Option Page Setup Menu -- Exit current page and return to Main Menu
F1 key	General help on Setup navigation keys
F5 key	Load previous values from CMOS
F6 key	Load the fail-safe defaults from BIOS default table
F7 key	Load the optimized defaults
F10 key	Save all the CMOS changes and exit

### Getting Help

Press F1 to pop up a small help window that describes the appropriate keys to use and the possible selections for the highlighted item. To exit the Help Window press <Esc> or the F1 key again.

### In Case of Problems

If, after making and saving system changes with Setup, you discover that your computer no longer is able to boot, the Award BIOS™ supports an override to the CMOS settings which resets your system to its defaults.

The best advice is to only alter settings which you thoroughly understand. To this end, we strongly recommend that you avoid making any changes to the chipset defaults.

These defaults have been carefully chosen by both Award and your systems manufacturer to provide the absolute maximum performance and reliability. Even a seemingly small change to the chipset setup has the potential for causing you to use the override.

### A Final Note About Setup

The information in this chapter is subject to change without notice.

Phoenix - AwardBIOS CMOS Setup Utility

<ul style="list-style-type: none"> <li>▶ Standard CMOS Features</li> <li>▶ Advanced BIOS Features</li> <li>▶ Advanced Chipset Features</li> <li>▶ Integrated Peripherals</li> <li>▶ Power Management Setup</li> <li>▶ PnP/PCI Configurations</li> <li>▶ PC Health Status</li> </ul>	<ul style="list-style-type: none"> <li>▶ Frequency Control</li> <li>Load Fail-Safe Defaults</li> <li>Load Optimized Defaults</li> <li>Set Supervisor Password</li> <li>Set User Password</li> <li>Save &amp; Exit Setup</li> <li>Exit Without Saving</li> </ul>
Esc : Quit      F9 : Menu in BIOS      ↑ ↓ → ← : Select Item F10 : Save & Exit Setup	
Time, Date, Hard Disk Type...	

## 3.2 Main Menu

Once you enter the Award BIOS CMOS Setup Utility, the Main Menu will appear on the screen. The Main Menu allows you to select from several setup functions and two exit choices. Use the arrow keys to select among the items and press <Enter> to accept and enter the sub-menu.

Note that a brief description of each highlighted selection appears at the bottom of the screen.

### Setup Items

The main menu includes the following main setup categories. Recall that some systems may not include all entries.

#### Standard CMOS Features

Use this menu for basic system configuration.

#### Advanced BIOS Features

Use this menu to set the Advanced Features available on your system.



**Advanced Chipset Features**

Use this menu to change the values in the chipset registers and optimize your system's performance.

**Integrated Peripherals**

Use this menu to specify your settings for integrated peripherals. See section 6.6. for the details.

**Power Management Setup**

Use this menu to specify your settings for power management.

**PnP / PCI Configuration**

This entry appears if your system supports PnP / PCI.

**Load Fail-Safe Defaults**

Use this menu to load the BIOS default values for the minimal/stable performance for your system to operate.

**Load Optimized Defaults**

Use this menu to load the BIOS default values that are factory settings for optimal performance system operations. While Award has designed the custom BIOS to maximize performance, the factory has the right to change these defaults to meet their needs.

**Supervisor / User Password**

Use this menu to set User and Supervisor Passwords.

**Save & Exit Setup**

Save CMOS value changes to CMOS and exit setup.

**Exit Without Save**

Abandon all CMOS value changes and exit setup.

**3.3 Standard CMOS Setup**Phoenix - AwardBIOS CMOS Setup Utility  
Standard CMOS Features

Date (mm:dd:yy)	Thu, Jan 1 2001	Item Help
Time (hh:mm:ss)	10 : 22 : 30	Menu Level ▶
▶ IDE Primary Master	[ None]	Change the day, month, year and century
▶ IDE Primary Slave	[ None]	
▶ IDE Secondary Master	[ None]	
▶ IDE Secondary Slave	[ None]	
Drive A	[1.44M, 3.5 in.]	
Drive B	[None]	
Video	[EGA/VGA]	
Halt On	[All , But Keyboard]	
Base Memory	640K	
Extended Memory	64512K	
Total Memory	65536K	

↑↓←→:Move Enter:Select +/-/PU/PD:Value F10:Save ESC:Exit F1:General Help  
F5: Previous Values F6: Fail-Safe Defaults F7: Optimized Defaults

The items in Standard CMOS Setup Menu are divided into 10 categories. Each category includes no, one or more than one setup items. Use the arrow keys to highlight the item and then use the <PgUp> or <PgDn> keys to select the value you want in each item.

**Main Menu Selections**

This table shows the selections that you can make on the Main Menu

Item	Options	Description
Date	Month DD YYYY	Set the system date. Note that the 'Day' automatically changes when you set the date
Time	HH : MM : SS	Set the system time
IDE Primary Master	Options are in its sub menu(described in Table 64)	Press <Enter> to enter the sub menu of detailed options
IDE Primary Slave	Options are in its sub menu(described in Table 64)	Press <Enter> to enter the sub menu of detailed options
IDE Secondary Master	Options are in its sub menu(described in Table 64)	Press <Enter> to enter the sub menu of detailed options
IDE Secondary Master	Options are in its sub menu(described in Table 64)	Press <Enter> to enter the sub menu of detailed options
Drive A Drive B	None 360K, 5.25 in 1.2M, 5.25 in 720K, 3.5 in 1.44M, 3.5 in 2.88M, 3.5 in	Select the type of floppy disk drive installed in your system

Item	Options	Description
Video	EGA/VGA CGA 40 CGA 80 MONO	Select the default video device
Halt On	All Errors No Errors All, but Keyboard All, but Diskette All, but Disk/Key	Select the situation in which you want the BIOS to stop the POST process and notify you
Base Memory	N/A	Displays the amount of conventional memory detected during boot up
Extended Memory	N/A	Displays the amount of extended memory detected during boot up
Total Memory	N/A	Displays the total memory available in the system

### IDE Adapters

The IDE adapters control the hard disk drive. Use a separate sub menu to configure each hard disk drive.

Use the legend keys to navigate through this menu and exit to the main menu. Use Table 3 to configure the hard disk.

Item	Options	Description
IDE HDD Auto-detection	Press Enter	Press Enter to auto-detect the HDD on this channel. If detection is successful, it fills the remaining fields on this menu.
IDE Primary Master	None Auto Manual	Selecting 'manual' lets you set the remaining fields on this screen. Selects the type of fixed disk. "User Type" will let you select the number of cylinders, heads, etc. Note: PRECOMP=65535 means NONE !
Capacity	Auto Display your disk drive size	Disk drive capacity (Approximated). Note that this size is usually slightly greater than the size of a formatted disk given by a disk checking program.
Access Mode	Normal LBA Large Auto	Choose the access mode for this hard disk
The following options are selectable only if the 'IDE Primary Master' item is set to 'Manual'		
Cylinder	Min = 0 Max = 65535	Set the number of cylinders for this hard disk.
Head	Min = 0 Max = 255	Set the number of read/write heads
Precomp	Min = 0 Max = 65535	**** Warning: Setting a value of 65535 means no hard disk

Item	Options	Description
Landing zone	Min = 0 Max = 65535	****
Sector	Min = 0 Max = 255	Number of sectors per track

### 3.4 Advanced BIOS Features Setup

This section allows you to configure your system for basic operation. You have the opportunity to select the system's default speed, boot-up sequence, keyboard operation, shadowing and security.

Phoenix - AwardBIOS CMOS Setup Utility  
Advanced BIOS Features

Item	Options	Item Help
Virus Warning	[Disabled]	Menu Level ▶  Allows you to choose the VIRUS warning feature for IDE Hard Disk boot sector protection. If this function is enabled and someone attempt to write data into this area, BIOS will show a warning message on screen and alarm beep
CPU L1 & L2 Cache	[Enabled]	
Quick Power On Self Test	[Enabled]	
First Boot Device	[Floppy]	
Second Boot Device	[HDD-0]	
Third Boot Device	[LS120]	
Boot Other Device	[Enabled]	
Swap Floppy Drive	[Disabled]	
Boot Up Floppy Seek	[Enabled]	
Boot Up NumLock Status	[On]	
Gate A20 Option	[Fast]	
Typeomatic Rate Setting	[Disabled]	
x Typeomatic Rate (Chars/Sec)	6	
x Typeomatic Delay (Msec)	250	
Security Option	[Setup]	
APIC Mode	[Enabled]	
MPS Version Control For OS	[1.4]	
OS Select For DRAM > 64MB	[Non-OS2]	
Report No FDD For WIN 95	[No]	

||←:Move Enter:Select +/-/PU/PD:Value F10:Save ESC:Exit F1:General Help  
F5: Previous Values F6: Fail-Safe Defaults F7: Optimized Defaults

#### Virus Warning

When enabled, you receive a warning message if a program (specifically, a virus) attempts to write to the boot sector or the partition table of the hard disk drive. You should then run an anti-virus program. Keep in mind that this feature protects only the boot sector, not the entire hard drive.

**NOTE:** Many disk diagnostic programs that access the boot sector table can trigger the virus warning message. If you plan to run such a program, we recommend that you first disable the virus warning.

Enabled	Activates automatically when the system boots up causing a warning message to appear when anything attempts to access the boot sector or hard disk partition table.
---------	---

Disabled	No warning message will appear when anything attempts to access the boot sector or hard disk partition table.
----------	---

Description	Choice
<p><b>CPU L1/L2 Cache ECC Checking</b></p> <p>When you select Enabled, memory checking is enabled when the external cache contains ECC SRAMs.</p>	<div style="border: 1px solid black; padding: 5px;"> <p>CPU L1 &amp; L2 Cache</p> <p>Enabled ..... <input checked="" type="checkbox"/></p> <p>Disabled ..... <input type="checkbox"/></p> <hr/> <p>↑↓:Move ENTER:Accept ESC:Abort</p> </div>
<p><b>Quick Power On Self Test</b></p> <p>Select Enabled to reduce the amount of time required to run the power-on self-test (POST). A quick POST skips certain steps. We recommend that you normally disable quick POST. Better to find a problem during POST than lose data during your work</p>	<div style="border: 1px solid black; padding: 5px;"> <p>Quick Power On Self Test</p> <p>Enabled ..... <input checked="" type="checkbox"/></p> <p>Disabled ..... <input type="checkbox"/></p> <hr/> <p>↑↓:Move ENTER:Accept ESC:Abort</p> </div>
<p><b>First/Second/Third/Other Boot Device</b></p> <p>The BIOS attempts to load the operating system from the devices in the sequence selected in these items.</p>	<div style="border: 1px solid black; padding: 5px;"> <p>First Boot Device</p> <p>Floppy ..... <input checked="" type="checkbox"/></p> <p>LS120 ..... <input type="checkbox"/></p> <p>HDD-0 ..... <input type="checkbox"/></p> <p>SCSI ..... <input type="checkbox"/></p> <p>CDROM ..... <input type="checkbox"/></p> <p>HDD-1 ..... <input type="checkbox"/></p> <p>HDD-2 ..... <input type="checkbox"/></p> <p>HDD-3 ..... <input type="checkbox"/></p> <p>ZIP100 ..... <input type="checkbox"/></p> <p>LAN ..... <input type="checkbox"/></p> <p>Disabled ..... <input type="checkbox"/></p> <hr/> <p>↑↓:Move ENTER:Accept ESC:Abort</p> </div>
<p><b>Swap Floppy Drive</b></p> <p>This field is effective only in systems with two floppy drives. Selecting Enabled assigns physical drive B to logical drive A, and physical drive A to logical drive B.</p> <p>If the system has two floppy drives, you can swap the logical drive name assignments.</p>	<div style="border: 1px solid black; padding: 5px;"> <p>Swap Floppy Drive</p> <p>Disabled ..... <input checked="" type="checkbox"/></p> <p>Enabled ..... <input type="checkbox"/></p> <hr/> <p>↑↓:Move ENTER:Accept ESC:Abort</p> </div>

Description	Choice
<p><b>Boot Up NumLock Status</b></p> <p>Toggle between On or Off to control the state of the NumLock key when the system boots. When toggled On, the numeric keypad generates numbers instead of controlling cursor operations.</p>	<div style="border: 1px solid black; padding: 5px;"> <p>Boot Up NumLock Status</p> <p>On ..... <input type="checkbox"/></p> <p>Off ..... <input checked="" type="checkbox"/></p> <hr/> <p>↑↓:Move ENTER:Accept ESC:Abort</p> </div>
<p><b>Gate A20 option</b></p> <p>Gate A20 refers to the way the system addresses memory above 1 MB (extended memory). When set to Fast, the system chipset controls Gate A20. When set to Normal, a pin in the keyboard controller controls Gate A20. Setting Gate A20 to Fast improves system speed, particularly with OS/2 and Windows</p>	<div style="border: 1px solid black; padding: 5px;"> <p>Gate A20 Option</p> <p>Normal ..... <input type="checkbox"/></p> <p>Fast ..... <input checked="" type="checkbox"/></p> <hr/> <p>↑↓:Move ENTER:Accept ESC:Abort</p> </div>
<p><b>Typematic Rate Setting</b></p> <p>When Disabled, the following two items (Typematic Rate and Typematic Delay) are irrelevant. Keystrokes repeat at a rate determined by the keyboard controller in your system. When Enabled, you can select a typematic rate and typematic delay.</p>	<div style="border: 1px solid black; padding: 5px;"> <p>Typematic Rate Setting</p> <p>Disabled ..... <input type="checkbox"/></p> <p>Enabled ..... <input checked="" type="checkbox"/></p> <hr/> <p>↑↓:Move ENTER:Accept ESC:Abort</p> </div>
<p><b>Typematic Rate (Chars/Sec)</b></p> <p>When the typematic rate setting is enabled, you can select a typematic rate (the rate at which character repeats when you hold down a key) of 6, 8, 10,12, 15, 20, 24 or 30 characters per second.</p>	<div style="border: 1px solid black; padding: 5px;"> <p>Typematic Rate (Chars/Sec)</p> <p>6 ..... <input checked="" type="checkbox"/></p> <p>8 ..... <input type="checkbox"/></p> <p>10 ..... <input type="checkbox"/></p> <p>12 ..... <input type="checkbox"/></p> <p>15 ..... <input type="checkbox"/></p> <p>20 ..... <input type="checkbox"/></p> <p>24 ..... <input type="checkbox"/></p> <p>30 ..... <input type="checkbox"/></p> <hr/> <p>↑↓:Move ENTER:Accept ESC:Abort</p> </div>

Description	Choice
<p><b>Typematic Delay (Msec)</b></p> <p>When the typematic rate setting is enabled, you can select a typematic delay (the delay before key strokes begin to repeat) of 250, 500, 750 or 1000 milliseconds.</p>	<pre> Typematic Delay (Msec) ----- 250 ..... [■] 500 ..... [ ] 750 ..... [ ] 1000 ..... [ ]  [↑↓]:Move ENTER:Accept ESC:Abort                     </pre>
<p><b>Security Option</b></p> <p>Select whether the password is required every time the system boots or only when you enter setup. If you have set a password, select whether the password is required every time the System boots, or only when you enter Setup.</p> <p>System: The system will not boot and access to Setup will be denied if the correct password is not entered at the prompt.</p> <p>Setup: The system will boot, but access to Setup will be denied if the correct password is not entered at the prompt.</p>	<pre> Security Option ----- Setup ..... [■] System ..... [ ]  [↑↓]:Move ENTER:Accept ESC:Abort                     </pre>
<p><b>Note:</b> To disable security, select <b>PASSWORD SETTING</b> at Main Menu and then you will be asked to enter password. Do not type anything and just press &lt;Enter&gt;, it will disable security. Once the security is disabled, the system will boot and you can enter Setup freely.</p>	
<p><b>OS Select For DRAM &gt; 64MB</b></p> <p>Select OS2 only if you are running OS/2 operating system with greater than 64 MB of RAM on your system.</p>	<pre> OS Select For DRAM &gt; 64MB ----- Non-OS2 ..... [■] OS2 ..... [ ]  [↑↓]:Move ENTER:Accept ESC:Abort                     </pre>
<p><b>Report No FDD For Win 95</b></p> <p>Select Yes to release IRQ6 when the system contains no floppy drive, for compatibility with Windows 95 logo certification. In the Integrated Peripherals screen, select Disabled for the Onboard FDC Controller field.</p>	<pre> Report No FDD For WIN 95 ----- No ..... [■] Yes ..... [ ]  [↑↓]:Move ENTER:Accept ESC:Abort                     </pre>

### 3.5 Advanced Chipset Features Setup

Phoenix - AwardBIOS CMOS Setup Utility  
Advanced Chipset Features

<pre> DRAM Timing Selectable [By SPD] CAS Latency Time [1.5] Active to Precharge Delay [7] DRAM RAS# to CAS# Delay [3] DRAM RAS# Precharge [3] Turbo Mode [Disabled] Memory Frequency For [Auto] System BIOS Cacheable [Enabled] Video BIOS Cacheable [Disabled] Memory Hole At 15M-16M [Disabled] Delayed Transaction [Enabled] Delay Prior to Thermal [16 Min] AGP Aperture Size (MB) [64]  ** On-Chip VGA Setting ** On-Chip VGA [Enabled] On-Chip Frame Buffer Size [8MB]                     </pre>	<p>Item Help</p> <p>Menu Level ▶</p>
--	--------------------------------------

[↑↓]:Move Enter:Select +/-/PU/PD:Value F10:Save ESC:Exit F1:General Help  
F5: Previous Values F6: Fail-Safe Defaults F7: Optimized Defaults

This section allows you to configure the system based on the specific features of the installed chipset. This chipset manages bus speeds and access to system memory resources, such as DRAM and the external cache. It also coordinates communications between the conventional ISA bus and the PCI bus. It must be stated that these items should never need to be altered. The default settings have been chosen because they provide the best operating conditions for your system. The only time you might consider making any changes would be if you discovered that data was being lost while using your system.

Description	Choice
<p><b>DRAM Timing Selectable</b></p> <p>The value in this field depends on performance parameters of the installed memory chips (DRAM). Do not change the value from the factory setting unless you install new memory that has a different performance rating than the original DRAMs</p>	<pre> DRAM Timing Selectable ----- Manual ..... [ ] By SPD ..... [■]  [↑↓]:Move ENTER:Accept ESC:Abort                     </pre>

Description	Choice
<p><b>CAS Latency Time</b> When synchronous DRAM is installed, the number of clock cycles of CAS latency depends on the DRAM timing. Do not reset this field from the default value specified by the system designer. You can select CAS latency time in HCLK of 2/2 or 3/3. The system board designer should set the values in this field, depends on the DRAM installed specifications of the installed DRAM or the installed CPU.</p>	<div style="border: 1px solid black; padding: 5px;"> <p style="text-align: center;">CAS Latency Time</p> <p>1.5 ..... <input checked="" type="checkbox"/></p> <p>2 ..... <input type="checkbox"/></p> <p>2.5 ..... <input type="checkbox"/></p> <hr/> <p style="text-align: center;">↑↓:Move ENTER:Accept ESC:Abort</p> </div>
<p><b>Active to Precharge delay</b> Select the precharge delay timer.</p>	<div style="border: 1px solid black; padding: 5px;"> <p style="text-align: center;">Active to Precharge Delay</p> <p>7 ..... <input checked="" type="checkbox"/></p> <p>6 ..... <input type="checkbox"/></p> <p>5 ..... <input type="checkbox"/></p> <hr/> <p style="text-align: center;">↑↓:Move ENTER:Accept ESC:Abort</p> </div>
<p><b>DRAM RAS# to CAS# delay</b> This field lets you insert a timing delay between the CAS and RAS strobe signals, used when DRAM is written to, read from, or refreshed. Fast gives faster performance; and Slow gives more stable performance. This field applies only when synchronous DRAM is installed in the system.</p>	<div style="border: 1px solid black; padding: 5px;"> <p style="text-align: center;">DRAM RAS# to CAS# Delay</p> <p>3 ..... <input checked="" type="checkbox"/></p> <p>2 ..... <input type="checkbox"/></p> <hr/> <p style="text-align: center;">↑↓:Move ENTER:Accept ESC:Abort</p> </div>
<p><b>DRAM RAS# Precharge</b> The precharge time is the number of cycles it takes for the RAS to accumulate its charge before DRAM refresh. If insufficient time is allowed, refresh may be incomplete and the DRAM may fail to retain data.</p>	<div style="border: 1px solid black; padding: 5px;"> <p style="text-align: center;">DRAM RAS# Precharge</p> <p>3 ..... <input checked="" type="checkbox"/></p> <p>2 ..... <input type="checkbox"/></p> <hr/> <p style="text-align: center;">↑↓:Move ENTER:Accept ESC:Abort</p> </div>

Description	Choice
<p><b>Memory Frequency for</b> Select the memory frequency for DDR200/DDR266 when install the memory with specification of DDR200, or when install the memory with specification of DDR266, or Auto define by the BIOS.</p>	<div style="border: 1px solid black; padding: 5px;"> <p style="text-align: center;">Memory Frequency For</p> <p>DDR200 .... <input type="checkbox"/></p> <p>DDR266 .... <input type="checkbox"/></p> <p>Auto ..... <input checked="" type="checkbox"/></p> <hr/> <p style="text-align: center;">↑↓:Move ENTER:Accept ESC:Abort</p> </div>
<p><b>System BIOS Cacheable</b> Selecting Enabled allows caching of the system BIOS ROM at F0000h-FFFFFh, resulting in better system performance. However, if any program writes to this memory area, a system error may result.</p>	<div style="border: 1px solid black; padding: 5px;"> <p style="text-align: center;">System BIOS Cacheable</p> <p>Disabled ..... <input type="checkbox"/></p> <p>Enabled ..... <input checked="" type="checkbox"/></p> <hr/> <p style="text-align: center;">↑↓:Move ENTER:Accept ESC:Abort</p> </div>
<p><b>Video BIOS Cacheable</b> Selecting Enabled allows caching of the video BIOS ROM at C0000h to C7FFFh, resulting in better video performance. However, if any program writes to this memory area, a system error may result.</p>	<div style="border: 1px solid black; padding: 5px;"> <p style="text-align: center;">Video BIOS Cacheable</p> <p>Disabled ..... <input checked="" type="checkbox"/></p> <p>Enabled ..... <input type="checkbox"/></p> <hr/> <p style="text-align: center;">↑↓:Move ENTER:Accept ESC:Abort</p> </div>
<p><b>Memory Hole At 15M-16M</b> You can reserve this area of system memory for ISA adapter ROM. When this area is reserved, it cannot be cached. The user information of peripherals that need to use this area of system memory usually discusses their memory requirements.</p>	<div style="border: 1px solid black; padding: 5px;"> <p style="text-align: center;">Memory Hole At 15M-16M</p> <p>Disabled ..... <input checked="" type="checkbox"/></p> <p>Enabled ..... <input type="checkbox"/></p> <hr/> <p style="text-align: center;">↑↓:Move ENTER:Accept ESC:Abort</p> </div>

Description	Choice
<p><b>Delay Transaction</b> The chipset has an embedded 32-bit posted write buffer to support delay transactions cycles. Select <i>Enabled</i> to support compliance with PCI specification version 2.1.</p>	<div style="border: 1px solid black; padding: 5px;"> <p>Delayed Transaction</p> <hr/> <p>Disabled ..... [ ] Enabled ..... [■]</p> <hr/> <p>↑↓:Move ENTER:Accept ESC:Abort</p> </div>
<p><b>Delay Prior to Thermal</b> Select the interval to setup the delay timer for CPU Thermal-Throttling.</p>	<div style="border: 1px solid black; padding: 5px;"> <p>Delay Prior to Thermal</p> <hr/> <p>4 Min ..... [ ] 8 Min ..... [ ] 16 Min ..... [■] 32 Min ..... [ ]</p> <hr/> <p>↑↓:Move ENTER:Accept ESC:Abort</p> </div>
<p><b>AGP Aperture Size (MB)</b> Select the size of the Accelerated Graphics Port (AGP) aperture. The aperture is a portion of the PCI memory address range dedicated for graphics memory address space. Host cycles that hit the aperture range are forwarded. Host cycles that hit the aperture range are forwarded to the AGP without any translation.</p>	<div style="border: 1px solid black; padding: 5px;"> <p>AGP Aperture Size (MB)</p> <hr/> <p>4 ..... [ ] 8 ..... [ ] 16 ..... [ ] 32 ..... [ ] 64 ..... [■] 128 ..... [ ] 256 ..... [ ]</p> <hr/> <p>↑↓:Move ENTER:Accept ESC:Abort</p> </div>
<p><b>On-Chip VGA setting</b></p>	
<p><b>On-Chip VGA</b> When Enabled to choice the on-board VGA function, otherwise disabled the on-board VGA function.</p>	<div style="border: 1px solid black; padding: 5px;"> <p>On-Chip VGA</p> <hr/> <p>Enabled ..... [■] Disabled ..... [ ]</p> <hr/> <p>↑↓:Move ENTER:Accept ESC:Abort</p> </div>

Description	Choice
<p><b>On chip Frame buffer size</b> When Enabled, a fixed VGA frame buffer from A000h to BFFFh and a CPU-to-PCI write buffer are implemented.</p>	<div style="border: 1px solid black; padding: 5px;"> <p>On-Chip Frame Buffer Size</p> <hr/> <p>1MB ..... [ ] 8MB ..... [■]</p> <hr/> <p>↑↓:Move ENTER:Accept ESC:Abort</p> </div>

### 3.6 Integrated Peripherals

Phoenix - AwardBIOS CMOS Setup Utility  
Integrated Peripherals

<p>On-Chip Primary PCI IDE [Enabled] IDE Primary Master PIO [Auto] IDE Primary Slave PIO [Auto] IDE Primary Master UDMA [Auto] IDE Primary Slave UDMA [Auto] On-Chip Secondary PCI IDE [Enabled] IDE Secondary Master PIO [Auto] IDE Secondary Slave PIO [Auto] IDE Secondary Master UDMA [Auto] IDE Secondary Slave UDMA [Auto] USB Controller [Enabled] USB 2.0 Controller [Enabled] USB Keyboard Support [Disabled] USB Mouse Support [Disabled] AC97 Audio [Auto] Init Display First [Onboard/AGP] Onboard 10/100-LAN control [Enabled] Onboard Giga-LAN control [Enabled] Onboard Raid-Chip control [Enabled] IDE HDD Block Mode [Enabled] Onboard FDC Controller [Enabled] Onboard Serial Port 1 [3F8/IRQ4] Onboard Serial Port 2 [2F8/IRQ3] Onboard Parallel Port [378/IRQ7] Parallel Port Mode [SPP] EPP Mode Select [EPP1.7] ECP Mode Use DMA [3] PWRON After PWR-Fail [Off]</p>	<p>Item Help Menu Level ▶</p>
<p>↑↓:Move Enter:Select +/-/PU/PD:Value F10:Save ESC:Exit F1:General Help F5: Previous Values F6: Fail-Safe Defaults F7: Optimized Defaults</p>	

Description	Choice
-------------	--------

Description	Choice
<p><b>On-Chip Primary PCI IDE</b></p> <p>The integrated peripheral controller contains an IDE interface with support for two IDE channels. Select <i>Enabled</i> to activate each channel separately.</p>	<p>On-Chip Primary PCI IDE</p> <p>Disabled ..... [ ]</p> <p>Enabled ..... [<input checked="" type="checkbox"/>]</p> <p>↑↓:Move ENTER:Accept ESC:Abort</p>
<p><b>IDE Primary Master/Slave PIO</b></p> <p>The four IDE PIO (Programmed Input/Output) fields let you set a PIO mode (0-4) for each of the four IDE devices that the onboard IDE interface supports. Modes 0 through 4 provide successively increased performance. In Auto mode, the system automatically determines the best mode for each device.</p>	<p>IDE Primary Master PIO</p> <p>Auto ..... [<input checked="" type="checkbox"/>]</p> <p>Mode 0 ..... [ ]</p> <p>Mode 1 ..... [ ]</p> <p>Mode 2 ..... [ ]</p> <p>Mode 3 ..... [ ]</p> <p>Mode 4 ..... [ ]</p> <p>↑↓:Move ENTER:Accept ESC:Abort</p>
<p><b>IDE Primary Master/Slave UDMA</b></p> <p>UDMA (Ultra DMA) is a DMA data transfer protocol that utilizes ATA commands and the ATA bus to allow DMA commands to transfer data at a maximum burst rate of 33 MB/s. When you select Auto in the four IDE UDMA fields (for each of up to four IDE devices that the internal PCI IDE interface supports), the system automatically determines the optimal data transfer rate for each IDE device.</p>	<p>IDE Primary Master UDMA</p> <p>Disabled ..... [ ]</p> <p>Auto ..... [<input checked="" type="checkbox"/>]</p> <p>↑↓:Move ENTER:Accept ESC:Abort</p>
<p><b>On-Chip Secondary PCI IDE</b></p> <p>The integrated peripheral controller contains an IDE interface with support for two IDE channels. Select <i>Enabled</i> to activate each channel separately.</p>	<p>On-Chip Secondary PCI IDE</p> <p>Disabled ..... [ ]</p> <p>Enabled ..... [<input checked="" type="checkbox"/>]</p> <p>↑↓:Move ENTER:Accept ESC:Abort</p>

Description	Choice
<p><b>IDE Secondary Master/Slave PIO</b></p> <p>The four IDE PIO (Programmed Input/Output) fields let you set a PIO mode (0-4) for each of the four IDE devices that the onboard IDE interface supports. Modes 0 through 4 provide successively increased performance. In Auto mode, the system automatically determines the best mode for each device.</p>	<p>IDE Secondary Master PIO</p> <p>Auto ..... [<input checked="" type="checkbox"/>]</p> <p>Mode 0 ..... [ ]</p> <p>Mode 1 ..... [ ]</p> <p>Mode 2 ..... [ ]</p> <p>Mode 3 ..... [ ]</p> <p>Mode 4 ..... [ ]</p> <p>↑↓:Move ENTER:Accept ESC:Abort</p>
<p><b>IDE Secondary Master/Slave UDMA</b></p> <p>UDMA (Ultra DMA) is a DMA data transfer protocol that utilizes ATA commands and the ATA bus to allow DMA commands to transfer data at a maximum burst rate of 33 MB/s. When you select Auto in the four IDE UDMA fields (for each of up to four IDE devices that the internal PCI IDE interface supports), the system automatically determines the optimal data transfer rate for each IDE device.</p>	<p>IDE Secondary Slave PIO</p> <p>Auto ..... [<input checked="" type="checkbox"/>]</p> <p>Mode 0 ..... [ ]</p> <p>Mode 1 ..... [ ]</p> <p>Mode 2 ..... [ ]</p> <p>Mode 3 ..... [ ]</p> <p>Mode 4 ..... [ ]</p> <p>↑↓:Move ENTER:Accept ESC:Abort</p>
<p><b>USB Controller</b></p> <p>Select <i>Enabled</i> if your system contains a Universal Serial Bus (USB) controller and you have USB peripherals.</p>	<p>USB Controller</p> <p>Enabled ..... [<input checked="" type="checkbox"/>]</p> <p>Disabled ..... [ ]</p> <p>↑↓:Move ENTER:Accept ESC:Abort</p>
<p><b>USB 2.0 controller</b></p> <p>Select <i>Enabled</i> if your system contains a Universal Serial Bus (USB 2.0) controller and you have USB peripherals.</p>	<p>USB 2.0 Controller</p> <p>Enabled ..... [<input checked="" type="checkbox"/>]</p> <p>Disabled ..... [ ]</p> <p>↑↓:Move ENTER:Accept ESC:Abort</p>

Description	Choice
<p>USB Keyboard Support</p> <p>Select <i>Enabled</i> if your system contains a Universal Serial Bus (USB) controller and you have a USB keyboard.</p>	<p>USB Keyboard Support</p> <p>Enabled ..... <input checked="" type="checkbox"/></p> <p>Disabled ..... <input type="checkbox"/></p> <p>↑↓:Move ENTER:Accept ESC:Abort</p>
<p>AC'97 Audio</p> <p>Select Enabled to use the audio capabilities of your system. Most of the following fields do not appear when this field is Disabled.</p>	<p>AC97 Audio</p> <p>Auto ..... <input checked="" type="checkbox"/></p> <p>Disabled ..... <input type="checkbox"/></p> <p>↑↓:Move ENTER:Accept ESC:Abort</p>
<p>Init Display First</p> <p>Initialize the AGP video display before initializing any other display device on the system. Thus the AGP display becomes the primary display.</p>	<p>Init Display First</p> <p>PCI Slot ..... <input type="checkbox"/></p> <p>Onboard/AGP ..... <input checked="" type="checkbox"/></p> <p>↑↓:Move ENTER:Accept ESC:Abort</p>
<p>Onboard CNR LAN control</p> <p>Select <i>Enabled</i> to active the onboard 10/100-LAN controller, select <i>Disabled</i> to turn-off the onboard 10/100-LAN controller when you do not want to use this function.</p>	<p>Onboard 10/100-LAN control</p> <p>Disabled ..... <input type="checkbox"/></p> <p>Enabled ..... <input checked="" type="checkbox"/></p> <p>↑↓:Move ENTER:Accept ESC:Abort</p>
<p>IDE HDD Block mode</p> <p>Block mode is also called block transfer, multiple commands, or multiple sector read/write. If your IDE hard drive supports block mode (most new drives do), select Enabled for automatic detection of the optimal number of block read/writes per sector the drive can support</p>	<p>IDE HDD Block Mode</p> <p>Disabled ..... <input type="checkbox"/></p> <p>Enabled ..... <input checked="" type="checkbox"/></p> <p>↑↓:Move ENTER:Accept ESC:Abort</p>

Description	Choice
<p>sector the drive can support.</p>	
<p>Onboard FDC Controller</p> <p>Select Enabled if your system has a floppy disk controller (FDC) installed on the system board and you wish to use it. If you install and-in FDC or the system has no floppy drive, select Disabled in this field.</p>	<p>Onboard FDC Controller</p> <p>Disabled ..... <input type="checkbox"/></p> <p>Enabled ..... <input checked="" type="checkbox"/></p> <p>↑↓:Move ENTER:Accept ESC:Abort</p>
<p>Onboard Serial Port 1</p> <p>Select a logical COM port name and matching address for the first and second serial ports. Select an address and corresponding interrupt for the first and second serial ports.</p>	<p>Onboard Serial Port 1</p> <p>Disabled ..... <input type="checkbox"/></p> <p>3F8/IRQ4 ..... <input checked="" type="checkbox"/></p> <p>2F8/IRQ3 ..... <input type="checkbox"/></p> <p>3E8/IRQ4 ..... <input type="checkbox"/></p> <p>2E8/IRQ3 ..... <input type="checkbox"/></p> <p>Auto ..... <input type="checkbox"/></p> <p>↑↓:Move ENTER:Accept ESC:Abort</p>
<p>Onboard Serial Port 2</p> <p>Select a logical COM port name and matching address for the first and second serial ports. Select an address and corresponding interrupt for the first and second serial ports.</p>	<p>Onboard Serial Port 2</p> <p>Disabled ..... <input type="checkbox"/></p> <p>3F8/IRQ4 ..... <input type="checkbox"/></p> <p>2F8/IRQ3 ..... <input checked="" type="checkbox"/></p> <p>3E8/IRQ4 ..... <input type="checkbox"/></p> <p>2E8/IRQ3 ..... <input type="checkbox"/></p> <p>Auto ..... <input type="checkbox"/></p> <p>↑↓:Move ENTER:Accept ESC:Abort</p>
<p>Onboard Parallel Port</p> <p>Select a logical LPT port name and matching address for the physical parallel (printer) port</p>	<p>Onboard Parallel Port</p> <p>Disabled ..... <input type="checkbox"/></p> <p>378/IRQ7 ..... <input checked="" type="checkbox"/></p> <p>278/IRQ5 ..... <input type="checkbox"/></p> <p>3BC/IRQ7 ..... <input type="checkbox"/></p> <p>↑↓:Move ENTER:Accept ESC:Abort</p>



Description	Choice
<p>Parallel Port Mode</p> <p>Selected an operating mode for the onboard parallel port. Select Compatible or extended unless you are certain both your hardware and software support EPP or ECP mode.</p>	<pre>Parallel Port Mode SPP ..... [■] EPP ..... [ ] ECP ..... [ ] ECP+EPP ..... [ ] Normal ..... [ ]  [↑↓]:Move ENTER:Accept ESC:Abort</pre>
<p>PWRON After PWR-Fail</p> <p>Select a Power On status by the BIOS setup when power fail.</p>	<pre>PWRON After PWR-Fail Off ..... [■] On ..... [ ] Former-Sts ..... [ ]  [↑↓]:Move ENTER:Accept ESC:Abort</pre>

### 3.7 Power Management Setup

The Power Management Setup allows you to configure you system to most effectively save energy while operating in a manner consistent with your own style of computer use.

Phoenix - AwardBIOS CMOS Setup Utility  
Power Management Setup

<pre>Power-Supply Type [AT] ACPI Function [Disabled] ACPI Suspend Type [S1(POS)] x Run VGABIOS if S3 Resume Auto Power Management [User Define] Video Off Method [DPMS] Video Off In Suspend [Yes] Suspend Type [Stop Grant] MODEM Use IRQ [3] HDD Power Down [Disabled] Soft-Off by PWR-BTTN [Instant-Off] Wake-Up by PCI card [Enabled] Power On by Ring [Enabled] x USB KB Wake-Up From S3 Disabled Resume by Alarm [Disabled] x Date(of Month) Alarm 0 x Time(hh:mm:ss) Alarm 0 : 0 : 0  ** Reload Global Timer Events ** Primary IDE 0 [Disabled] Primary IDE 1 [Disabled] Secondary IDE 0 [Disabled] Secondary IDE 1 [Disabled] FDD,COM,LPT Port [Disabled] PCI PIRQ[A-D]# [Disabled]</pre>		<p>Item Help</p> <p>Menu Level ▶</p> <p>Item Help</p> <p>Menu Level ▶</p>
---	---	---

[↑↓]:Move Enter:Select +/-/PU/PD:Value F10:Save ESC:Exit F1:General Help  
F5: Previous Values F6: Fail-Safe Defaults F7: Optimized Defaults

Description	Choice
<p>ACPI function</p> <p>Select to Enabled the ACPI function and select Disabled to disable the APCI.</p>	<pre>ACPI Function Enabled ..... [■] Disabled ..... [ ]  [↑↓]:Move ENTER:Accept ESC:Abort</pre>
<p>Power management</p>	<pre>Power Management User Define ..... [■] Min Saving ..... [ ] Max Saving ..... [ ]  [↑↓]:Move ENTER:Accept ESC:Abort</pre>

Description	Choice
Video Off Method	<div style="border: 1px solid black; padding: 5px;"> <p>Video Off Method</p> <p>Blank Screen ..... [ ]</p> <p>V/H SYNC+Blank ..... [ ]</p> <p>DPMS ..... [■]</p> <p>↑↓:Move ENTER:Accept ESC:Abort</p> </div>
Video Off In Suspend This determines the manner in which the monitor is blanked.	<div style="border: 1px solid black; padding: 5px;"> <p>Video Off In Suspend</p> <p>No ..... [ ]</p> <p>Yes ..... [■]</p> <p>↑↓:Move ENTER:Accept ESC:Abort</p> </div>
Suspend Type Select the Suspend Type.	<div style="border: 1px solid black; padding: 5px;"> <p>Suspend Type</p> <p>Stop Grant ..... [■]</p> <p>PwrOn Suspend ..... [ ]</p> <p>↑↓:Move ENTER:Accept ESC:Abort</p> </div>
MODEM Use IRQ Name the interrupt request (IRQ) line assigned to the modem (if any) on your system. Activity of the selected IRQ always awakens the system.	<div style="border: 1px solid black; padding: 5px;"> <p>MODEM Use IRQ</p> <p>NA ..... [ ]</p> <p>3 ..... [■]</p> <p>4 ..... [ ]</p> <p>5 ..... [ ]</p> <p>7 ..... [ ]</p> <p>9 ..... [ ]</p> <p>10 ..... [ ]</p> <p>11 ..... [ ]</p> <p>↑↓:Move ENTER:Accept ESC:Abort</p> </div>

Description	Choice
HDD Power Down When enabled and after the set time of system inactivity, the hard disk drive will be powered down while all other devices remain active.	<div style="border: 1px solid black; padding: 5px;"> <p>HDD Power Down</p> <p>Disable ..... [■]</p> <p>1 Min ..... [ ]</p> <p>2 Min ..... [ ]</p> <p>3 Min ..... [ ]</p> <p>4 Min ..... [ ]</p> <p>5 Min ..... [ ]</p> <p>6 Min ..... [ ]</p> <p>7 Min ..... [ ]</p> <p>8 Min ..... [ ]</p> <p>9 Min ..... [ ]</p> <p>10 Min ..... [ ]</p> <p>11 Min ..... [ ]</p> <p>12 Min ..... [ ]</p> <p>13 Min ..... [ ]</p> <p>14 Min ..... [ ]</p> <p>15 Min ..... [■]</p> <p>↑↓:Move ENTER:Accept ESC:Abort</p> </div>
Soft-Off by PWR-BTTN When enabled, turning the system off with the on/off button places the system in a very low-power-usage state, with only enough circuitry receiving power to detect power button activity or Resume by Ring activity.	<div style="border: 1px solid black; padding: 5px;"> <p>Soft-Off by PWR-BTTN</p> <p>Instant-Off ..... [■]</p> <p>Delay 4 Sec. .... [ ]</p> <p>↑↓:Move ENTER:Accept ESC:Abort</p> </div>
Wake up by PCI card When Enabled, your can awakens the system from Suspend mode from a PCI card event.	<div style="border: 1px solid black; padding: 5px;"> <p>Wake-Up by PCI card</p> <p>Disabled ..... [ ]</p> <p>Enabled ..... [■]</p> <p>↑↓:Move ENTER:Accept ESC:Abort</p> </div>
Power On by Ring An input signal on the serial Ring Indicator (RI) line (in other words, an incoming call on the modem) awakens the system from a soft off state.	<div style="border: 1px solid black; padding: 5px;"> <p>Power On by Ring</p> <p>Disabled ..... [ ]</p> <p>Enabled ..... [■]</p> <p>↑↓:Move ENTER:Accept ESC:Abort</p> </div>

Description	Choice
<p><b>Resume by Alarm</b></p> <p>When Enabled, you can set the date and time at which the RTC (real-time clock) alarm awakens the system from Suspend mode.</p>	<pre> Resume by Alarm ----- Disabled ..... [ ] Enabled ..... [■]    :Move ENTER:Accept ESC:Abort                     </pre>

Description	Choice				
<p><b>Reload Global Timer Events:</b> When Enabled, an event occurring on each listed device restarts the global timer for Standby mode.</p>	<table border="1"> <tr> <td> <pre> Primary IDE 0/1 ----- Disabled ..... [■] Enabled ..... [ ]    :Move ENTER:Accept ESC:Abort                     </pre> </td> <td> <pre> Secondary IDE 0/1 ----- Disabled ..... [■] Enabled ..... [ ]    :Move ENTER:Accept ESC:Abort                     </pre> </td> </tr> <tr> <td> <pre> FDD,COM,LPT Port ----- Disabled ..... [■] Enabled ..... [ ]    :Move ENTER:Accept ESC:Abort                     </pre> </td> <td> <pre> PCI PIRQ[A-D]# ----- Disabled ..... [■] Enabled ..... [ ]    :Move ENTER:Accept ESC:Abort                     </pre> </td> </tr> </table>	<pre> Primary IDE 0/1 ----- Disabled ..... [■] Enabled ..... [ ]    :Move ENTER:Accept ESC:Abort                     </pre>	<pre> Secondary IDE 0/1 ----- Disabled ..... [■] Enabled ..... [ ]    :Move ENTER:Accept ESC:Abort                     </pre>	<pre> FDD,COM,LPT Port ----- Disabled ..... [■] Enabled ..... [ ]    :Move ENTER:Accept ESC:Abort                     </pre>	<pre> PCI PIRQ[A-D]# ----- Disabled ..... [■] Enabled ..... [ ]    :Move ENTER:Accept ESC:Abort                     </pre>
<pre> Primary IDE 0/1 ----- Disabled ..... [■] Enabled ..... [ ]    :Move ENTER:Accept ESC:Abort                     </pre>	<pre> Secondary IDE 0/1 ----- Disabled ..... [■] Enabled ..... [ ]    :Move ENTER:Accept ESC:Abort                     </pre>				
<pre> FDD,COM,LPT Port ----- Disabled ..... [■] Enabled ..... [ ]    :Move ENTER:Accept ESC:Abort                     </pre>	<pre> PCI PIRQ[A-D]# ----- Disabled ..... [■] Enabled ..... [ ]    :Move ENTER:Accept ESC:Abort                     </pre>				

### 3.8 PnP/PCI Configuration Setup

This section describes configuring the PCI bus system. PCI, or **Personal Computer Interconnect**, is a system which allows I/O devices to operate at speeds nearing the speed the CPU itself uses when communicating with its own special components. This section covers some very technical items and it is strongly recommended that only experienced users should make any changes to the default settings.

Phoenix - AwardBIOS CMOS Setup Utility  
PnP/PCI Configurations

PNP OS Installed [No] Reset Configuration Data [Disabled]	Resources Controlled By [Manual] ▶ IRQ Resources [Press Enter]	Item Help  Menu Level ▶  Select Yes if you are using a Plug and Play capable operating system. Select No if you need the BIOS to configure non-boot devices.
PCI/VGA Palette Snoop [Disabled]		

↑↓←→: Move Enter: Select +/-/PU/PD: Value F10: Save ESC: Exit F1: General Help  
 F5: Previous Values F6: Fail-Safe Defaults F7: Optimized Defaults

Description	Choices		
<b>Resource Controlled by</b> The Award Plug and Play BIOS can automatically configure all the boot and Plug and Play – compatible devices. If you select Auto, all the interrupt request (IRQ) and DMA assignment fields disappear, as the BIOS automatically assigns them.	<table border="1" style="width: 100%; border-collapse: collapse;"> <tr> <td style="padding: 5px;"> <b>Reset Configuration Data</b>                              Disabled ..... [ ]                              Enabled ..... [ ]                         </td> </tr> <tr> <td style="padding: 5px; text-align: center;">                             ↑↓: Move ENTER: Accept ESC: Abort                         </td> </tr> </table>	<b>Reset Configuration Data</b> Disabled ..... [ ] Enabled ..... [ ]	↑↓: Move ENTER: Accept ESC: Abort
<b>Reset Configuration Data</b> Disabled ..... [ ] Enabled ..... [ ]			
↑↓: Move ENTER: Accept ESC: Abort			
<b>Reset Configuration Data</b> Normally, you leave this field Disabled. Select Enabled to reset Extended System Configuration Data (ESCD) when you exit Setup if you have installed a new add-on and the system reconfiguration has caused such a serious conflict that the operating system can not boot.	<table border="1" style="width: 100%; border-collapse: collapse;"> <tr> <td style="padding: 5px;"> <b>Resources Controlled By</b>                              Auto &lt;ESCD&gt; ..... [ ]                              Manual ..... [ ]                         </td> </tr> <tr> <td style="padding: 5px; text-align: center;">                             ↑↓: Move ENTER: Accept ESC: Abort                         </td> </tr> </table>	<b>Resources Controlled By</b> Auto <ESCD> ..... [ ] Manual ..... [ ]	↑↓: Move ENTER: Accept ESC: Abort
<b>Resources Controlled By</b> Auto <ESCD> ..... [ ] Manual ..... [ ]			
↑↓: Move ENTER: Accept ESC: Abort			

### IRQ n Resources

Phoenix - AwardBIOS CMOS Setup Utility  
IRQ Resources

IRQ-3 assigned to [PCI/ISA PnP] IRQ-4 assigned to [PCI/ISA PnP] IRQ-5 assigned to [PCI/ISA PnP] IRQ-7 assigned to [PCI/ISA PnP] IRQ-9 assigned to [PCI/ISA PnP] IRQ-10 assigned to [PCI/ISA PnP] IRQ-11 assigned to [PCI/ISA PnP] IRQ-12 assigned to [PCI/ISA PnP] IRQ-14 assigned to [PCI/ISA PnP] IRQ-15 assigned to [PCI/ISA PnP]	Item Help  Menu Level ▶▶  Legacy ISA for devices compliant with the original PC AT bus specification, PCI/ISA PnP for devices compliant with the Plug and Play standard whether designed for PCI or ISA bus architecture.
---	---

↑↓←→: Move Enter: Select +/-/PU/PD: Value F10: Save ESC: Exit F1: General Help  
 F5: Previous Values F6: Fail-Safe Defaults F7: Optimized Defaults

When resources are controlled manually, assign each system interrupt as on of the following type, depending on the type of device using the interrupt.

Legacy ISA Devices compliant with the original PC AT bus specification, requiring a specific interrupt (Such as IRQ4 for serial port 1)

PCI/ISA PnP Devices compliant with the Plug and Play standard, whether designed for PCI or ISA bus architecture.

The Choice: *Legacy ISA* and *PCI/ISA PnP*.

<b>PCI/VGA Palette Snoop</b>  Disabled ..... [ ] Enabled ..... [ ]	<b>PCI/VGA Palette Snoop</b> Leave this field at Disabled.
↑↓: Move ENTER: Accept ESC: Abort	

### 3.9 PC Health Status

Phoenix - AwardBIOS CMOS Setup Utility  
PC Health Status

Current System Temp. Current CPU1 Temperature Current CUFAN Speed : Current SYSTEMFAN Speed Vcore VTT +3.3V + 5 V +12 V -12 V - 5 V VBAT(V)	Item Help Menu Level ▶
--	---------------------------

↑↓←→:Move Enter:Select +/-/PU/PD:Value F10:Save ESC:Exit F1:General Help  
F5: Previous Values F6: Fail-Safe Defaults F7: Optimized Defaults

The BIOS shows the PC health status in this window.

Item	Description
<b>Current CPU Temp.</b>	This field displays the current CPU temperature, if your computer contains a monitoring system.
<b>Current System Temp.</b>	This field displays the current system temperature, if your computer contains a monitoring system.
<b>Current CUFAN Speed</b>	These fields display the current speed of up to three CPU fans, if your computer contains a monitoring system.
<b>+12V / -12V / +5V / -5V / +3.3V / VBAT</b>	These fields display the current voltage of input lines, if your computer contains a monitoring system.

### 3.10 Defaults Menu

Selecting “Defaults” from the main menu shows you, which are described below

#### Load Optimized Defaults

When you press <Enter> on this item you get a confirmation dialog box with a message similar to:

*Load Optimized Defaults (Y/N) ? N*

Pressing ‘Y’ loads the default values that are factory settings for optimal performance system operations.

### 3.11 Supervisor/User Password Setting

You can set either supervisor or user password, or both of them. The differences between are:

**SUPERVISOR PASSWORD:** can enter and change the options of the setup menus.

**USER PASSWORD:** just can only enter but do not have the right to change the options of the setup menus. When you select this unction, the following message will appear at the center of the screen to assist you in creating a password.

#### *ENTER PASSWORD:*

Type the password, up to eight characters in length, and press <Enter>. The password typed now will clear any previously entered password from CMOS memory. You will be asked to confirm the password. Type the password again and press <Enter>. You may also press <Esc> to abort the selection and not enter a password.

To disable a password, just press <Enter> when you are prompted to enter the password. A message will confirm the password will be disabled. Once the password is disabled, the system will boot and you can enter Setup freely.

#### *PASSWORD DISABLED.*

When a password has been enabled, you will be prompted to enter it every time you try to enter Setup. This prevents an unauthorized person from changing any part of your system configuration.

Additionally, when a password is enabled, you can also require the BIOS to request a password every time your system is rebooted. This would prevent unauthorized use of your computer.

You determine when the password is required within the BIOS Features Setup Menu and its Security option (see Section 3). If the Security option is set to “System”, the password will be required both at boot and at entry to Setup. If set to “Setup”, prompting only occurs when trying to enter Setup.

### 3.12 Exit Selecting

Save & Exit Setup

Pressing <Enter> on this item asks for confirmation:

**Save to CMOS and EXIT (Y/N)?** **Y**

Pressing “Y” stores the selections made in the menus in CMOS – a special section of memory that stays on after you turn your system off. The next time you boot your computer, the BIOS configures your system according to the Setup selections stored in CMOS. After saving the values the system is restarted again.

Exit Without Saving

Pressing <Enter> on this item asks for confirmation:

**Quit without saving (Y/N)?** **Y**

This allows you to exit Setup without storing in CMOS any change. The previous selections remain in effect. This exits the Setup utility and restarts your computer.

### 3.13 POST Messages

During the Power On Self-Test (POST), if the BIOS detects an error requiring you to do something to fix, it will either sound a beep code or display a message.

If a message is displayed, it will be accompanied by:

PRESS F1 TO CONTINUE, CTRL-ALT-ESC OR DEL TO ENTER SETUP

### 3.14 POST Beep

Currently there are two kinds of beep codes in BIOS. This code indicates that a video error has occurred and the BIOS cannot initialize the video screen to display any additional information. This beep code consists of a single long beep followed by two short beeps. The other code indicates that your DRAM error has occurred. This beep code consists of a single long beep repeatedly.

### 3.15 Error Messages

One or more of the following messages may be displayed if the BIOS detects an error during the POST. This list includes messages for both the ISA and the EISA BIOS.

CMOS battery has failed

CMOS battery is no longer functional. It should be replaced.

CMOS checksum error

Checksum of CMOS is incorrect. This can indicate that CMOS has become corrupt. This error may have been caused by a weak battery. Check the battery and replace if necessary.

DISK BOOT failure

**INSERT SYSTEM DISK AND PRESS ENTER**

No boot device was found. This could mean that either a boot drive was not detected or the drive does not contain proper system boot files. Insert a system disk into Drive A: and press <Enter>. If you assumed the system would boot from the hard drive, make sure the controller is inserted correctly and all cables are properly attached. Also be sure the disk is formatted as a boot device. Then reboot the system.

Diskette drives or types mismatch error

**RUN SETUP**

Type of diskette drive installed in the system is different from the CMOS definition. Run Setup to reconfigure the drive type correctly.

Display switch is set incorrectly

Display switch on the motherboard can be set to either monochrome or color. This indicates the switch is set to a different setting than indicated in Setup. Determine which setting is correct, and then either turn off the system and change the jumper, or enter Setup and change the VIDEO selection.

Display type has changed since last BOOT

Since last powering off the system, the display adapter has been changed. You must configure the system for the new display type.

EISA configuration checksum error

**PLEASE RUN EISA CONFIGURATION UTILITY**

The EISA non-volatile RAM checksum is incorrect or cannot correctly read the EISA slot. This can indicate either the EISA non-volatile memory has become corrupt or the slot has been configured incorrectly. Also be sure the card is installed firmly in the slot.

EISA configuration is not complete

**PLEASE RUN EISA CONFIGURATION UTILITY**

The slot configuration information stored in the EISA non-volatile memory is incomplete.

Note: When either of these errors appear, the system will boot in ISA mode, which allows you to run the EISA Configuration Utility.

#### Error encountered initializing hard drive

Hard drive cannot be initialized. Be sure the adapter is installed correctly and all cables are correctly and firmly attached. Also be sure the correct hard drive type is selected in Setup.

#### Error initializing hard disk controller

Cannot initialize controller. Make sure the cord is correctly and firmly installed in the bus. Be sure the correct hard drive type is selected in Setup. Also check to see if any jumper needs to be set correctly on the hard drive.

#### Floppy disk controller error or no controller present

Cannot find or initialize the floppy drive controller. Make sure the controller is installed correctly and firmly. If there are no floppy drives installed, be sure the Diskette Drive selection in Setup is set to NONE.

#### Invalid EISA configuration

#### **PLEASE RUN EISA CONFIGURATION UTILITY**

The non-volatile memory containing EISA configuration information was programmed incorrectly or has become corrupt. Re-run EISA configuration utility to correctly program the memory.

NOTE: When this error appears, the system will boot in ISA mode, which allows you to run the EISA Configuration Utility.

#### Keyboard error or no keyboard present

Cannot initialize the keyboard. Make sure the keyboard is attached correctly and no keys are being pressed during the boot.

If you are purposely configuring the system without a keyboard, set the error halt condition in Setup to HALT ON ALL, BUT KEYBOARD. This will cause the BIOS to ignore the missing keyboard and continue the boot.

#### Memory address error at ...

Indicates a memory address error at a specific location. You can use this location along with the memory map for your system to find and replace the bad memory chips.

#### Memory parity error at ...

Indicates a memory parity error at a specific location. You can use this location along with

the memory map for your system to find and replace the bad memory chips.

#### Memory size has changed since last BOOT

Memory has been added or removed since the last boot. In EISA mode use Configuration Utility to reconfigure the memory configuration. In ISA mode enter Setup and enter the new memory size in the memory fields.

#### Memory verify error at ...

Indicates an error verifying a value already written to memory. Use the location along with your system's memory map to locate the bad chip.

#### Offending address not found

This message is used in conjunction with the I/O CHANNEL CHECK and RAM PARITY ERROR messages when the segment that has caused the problem cannot be isolated.

#### Offending segment

This message is used in conjunction with the I/O CHANNEL CHECK and RAM PARITY ERROR messages when the segment that has caused the problem has been isolated.

#### Press a key to REBOOT

This will be displayed at the bottom screen when an error occurs that requires you to reboot.

Press any key and the system will reboot.

#### Press F1 to disable NMI, F2 to REBOOT

When BIOS detects a Non-maskable Interrupt condition during boot, this will allow you to disable the NMI and continue to boot, or you can reboot the system with the NMI enabled.

#### RAM parity error

#### **CHECKING FOR SEGMENT ...**

Indicates a parity error in Random Access Memory.

Should be empty but EISA board found

#### **PLEASE RUN EISA CONFIGURATION UTILITY**

A valid board ID was found in a slot that was configured as having no board ID.

NOTE: When this error appears, the system will boot in ISA mode, which allows you to run the EISA Configuration Utility.

Should have EISA board but not found

#### **PLEASE RUN EISA CONFIGURATION UTILITY**

The board installed is not responding to the ID request, or no board ID has been found in the indicated slot.

NOTE: When this error appears, the system will boot in ISA mode, which allows you to run the EISA Configuration Utility.

#### Slot not empty

Indicates that a slot designated as empty by the EISA Configuration Utility actually contains a board.

NOTE: When this error appears, the system will boot in ISA mode, which allows you to run the EISA Configuration Utility.

#### System halted, (CTRL-ALT-DEL) to REBOOT ...

Indicates the present boot attempt has been aborted and the system must be rebooted. Press and hold down the CTRL and ALT keys and press DEL.

#### Wrong board in slot

##### **PLEASE RUN EISA CONFIGURATION UTILITY**

The board ID does not match the ID stored in the EISA non-volatile memory.

NOTE: When this error appears, the system will boot in ISA mode, which allows you to run the EISA Configuration Utility.

#### Floppy disk(s) fail (80)

Unable to reset floppy subsystem.

#### Floppy disk(s) fail (40)

Floppy Type mismatch.

#### Hard disk(s) fail (80)

HDD reset failed.

#### Hard disk(s) fail (40)

HDD controller diagnostics failed.

#### Hard disk(s) fail (20)

HDD initialization error.

#### Hard disk(s) fail (10)

Unable to recalibrate fixed disk.

#### Hard disk(s) fail (08)

Sector Verify failed.

#### Keyboard is locked out - Unlock the key.

Unlock the key. BIOS detect the keyboard is locked. P17 of keyboard controller is pulled low.

#### Keyboard error or no keyboard present

Cannot initialize the keyboard. Make sure the keyboard is attached correctly and no keys are being pressed during the boot.

#### Manufacturing POST loop

System will repeat POST procedure infinitely while the P15 of keyboard controller is pulling low. This

is also used for M/B burn in test.

#### BIOS ROM checksum error - System halted

The checksum of ROM address F0000H-FFFFFH is bad.

#### Memory test fail

BIOS reports the memory tests fail if the onboard memory is tested error.



## APPENDIX Watch-Dog-Timer (WDT) Setting

### 一 . Definition for SYS7180VE watchdog

The watchdog timer can be adjusted by software setting from 1second to 239seconds or from 1 minute to 239 minutes. The I/O port is defined at address EFH. You can trigger/enable/disable the timer by writing port EFH.

FOH: timer for minute

F1H: timer for second

0: disable the timer

### 二 . Test procedure in DOS

Implement Debug order in MS-DOS:

o ef f1

o ef 5

[ enter]

The system will reset after 5 seconds

### 三 . Assembly language example

Timer for second:

```
mov AL, f1
```

```
mov dx, ef
```

```
out dx, AL
```

```
mov AL, 65 (time for 65 sec. decimal system )
```

```
mov dx, ef
```

```
out dx, AL
```

Timer for minute:

```
mov AL, f0
```

```
mov dx, ef
```

```
out dx, AL
```

```
mov AL, 75 (time for 75 min. decimal system )
```

```
mov dx, ef
```

```
out dx, AL
```

Disable the watchdog-timer:

```
mov AL, 0
```

```
mov dx, ef
```

```
out dx, AL
```

NOTE: Because WIN NT , win2000 , win2003 , winXP are not effective by writing the port directly, so we must make lib file, driver or DLL first.

