

BRIGGS & STRATTON



PROMAX

030212 (2.5 kW)

030213 (2.8 kW)

CAUTION

Before using this product, read this manual and follow all Safety Rules and Operating Instructions.

Owner's Manual



Questions?

Help is just a moment away!

Find your Briggs and Stratton distributor
at www.briggsandstratton.com

or contact your local Briggs and Stratton dealer.

BRIGGS & STRATTON POWER PRODUCTS GROUP, LLC
JEFFERSON, WISCONSIN, U.S.A.

Manual No. 196978GS
Revision 0 (04/22/2005)



TABLE OF CONTENTS

Safety Rules 2-4
 Know Your Generator 5-6
 Assembly 7
 Operation 8-11
 Specifications 12
 Maintenance 12
 Storage 13
 Troubleshooting 14
 Notes 15
 Warranty 16

EQUIPMENT DESCRIPTION



Read this manual carefully and become familiar with your generator. Know its applications, its limitations and any hazards involved.

These generators are engine-driven, revolving field, alternating current (AC) generators. Each was designed to supply electrical power for operating compatible electrical lighting, appliances, tools and motor loads. The generator's revolving field is driven at about 3,000 rpm by a single-cylinder engine.

CAUTION! DO NOT exceed the generator's wattage/amperage capacity. See "Don't Overload Generator".

Every effort has been made to ensure that information in this manual is accurate and current. However, we reserve the right to change, alter or otherwise improve the product and this document at any time without prior notice.

The Emission Control System for this generator is warranted for standards set by the Environmental Protection Agency. For warranty information refer to the engine owner's manual.

SAFETY RULES











This is the safety alert symbol. It is used to alert you to potential personal injury hazards. Obey all safety messages that follow this symbol to avoid possible injury or death.

The safety alert symbol () is used with a signal word (DANGER, CAUTION, WARNING), a pictorial and/or a safety message to alert you to hazards. **DANGER** indicates a hazard which, if not avoided, *will* result in death or serious injury. **WARNING** indicates a hazard which, if not avoided, *could* result in death or serious injury. **CAUTION** indicates a hazard which, if not avoided, *might* result in minor or moderate injury. **CAUTION**, when used **without** the alert symbol, indicates a situation that could result in equipment damage. Follow safety messages to avoid or reduce the risk of injury or death.

 WARNING
The engine exhaust from this product contains chemicals known to the State of California to cause cancer, birth defects, or other reproductive harm.

Hazard Symbols and Meanings

		
Electrocution	Electrical Shock	Electrical Shock
		
Explosion	Fire	
		
Toxic Fumes	Kickback	Hot Surface

SAFETY RULES



WARNING



Running generator gives off carbon monoxide, an odorless, colorless, poison gas.

Breathing carbon monoxide will cause nausea, fainting or death.

- Operate generator **ONLY** outdoors.
- Keep exhaust gas from entering a confined area through windows, doors, ventilation intakes or other openings.
- **DO NOT** operate generator inside any building or enclosure, including the generator compartment of a recreational vehicle (RV).

WARNING



Generator produces powerful voltage.

Failure to isolate generator from power utility can result in death or injury to electric utility workers due to backfeed of electrical energy.

- When using generator for backup power, notify utility company. Use approved transfer equipment to isolate generator from electric utility.
- Use a ground fault circuit interrupter (GFCI) in any damp or highly conductive area, such as metal decking or steel work.
- **DO NOT** touch bare wires or receptacles.
- **DO NOT** use generator with electrical cords which are worn, frayed, bare or otherwise damaged.
- **DO NOT** operate generator in the rain.
- **DO NOT** handle generator or electrical cords while standing in water, while barefoot, or while hands or feet are wet.
- **DO NOT** allow unqualified persons or children to operate or service generator.

WARNING

- This generator must not be used on marine applications.
- Using this generator in marine applications could result in bodily injury and/or property damage.

WARNING



Petrol and its vapors are extremely flammable and explosive.



Fire or explosion can cause severe burns or death.

WHEN ADDING OR DRAINING PETROL

- Turn generator **OFF** and let it cool at least 2 minutes before removing petrol cap. Loosen cap slowly to relieve pressure in tank.
- Fill or drain petrol tank outdoors.
- **DO NOT** overfill tank. Allow space for petrol expansion.
- Keep petrol away from sparks, open flames, pilot lights, heat, and other ignition sources.
- **DO NOT** light a cigarette or smoke.

WHEN STARTING EQUIPMENT

- Ensure spark plug, muffler, petrol cap and air cleaner are in place.
- **DO NOT** crank engine with spark plug removed.
- If petrol spills, wait until it evaporates before starting engine.

WHEN OPERATING EQUIPMENT

- Do not tip engine or equipment at angle which causes petrol to spill.
- This generator is not for use in mobile equipment or marine applications.

WHEN TRANSPORTING OR REPAIRING EQUIPMENT

- Transport/repair with petrol tank **EMPTY** or with petrol shutoff valve **OFF**.
- Disconnect spark plug wire.

WHEN STORING PETROL OR EQUIPMENT WITH PETROL IN TANK

- Store away from furnaces, stoves, water heaters, clothes dryers or other appliances that have pilot light or other ignition source because they can ignite petrol vapors.



SAFETY RULES

WARNING



Rapid retraction of starter cord (kickback) will pull hand and arm toward engine faster than you can let go.

Broken bones, fractures, bruises or sprains could result.

- When starting engine, pull cord slowly until resistance is felt and then pull rapidly to avoid kickback.
- NEVER start or stop engine with electrical devices plugged in and turned on.

WARNING



Unintentional sparking can result in fire or electric shock.



WHEN ADJUSTING OR MAKING REPAIRS TO YOUR GENERATOR

- Disconnect the spark plug wire from the spark plug and place the wire where it cannot contact spark plug.

WHEN TESTING FOR ENGINE SPARK

- Use approved spark plug tester.
- DO NOT check for spark with spark plug removed.

WARNING



Running engines produce heat. Temperature of muffler and nearby areas can reach or exceed 65°C (150°F).



Severe burns can occur on contact.

Combustible debris, such as leaves, grass, brush, ect. can catch fire.

- DO NOT touch hot surfaces.
- Allow equipment to cool before touching.
- The generator must be at least 2m (5 ft) from structures having combustible walls and/or other combustible materials.
- Keep at least 1m (3 ft) of clearance on all sides of generator for adequate cooling, maintenance and servicing.

CAUTION

Excessively high operating speeds increase risk of injury and damage to generator.

Excessively low speeds impose a heavy load.

- DO NOT tamper with governed speed. Generator supplies correct rated frequency and voltage when running at governed speed.
- DO NOT modify generator in any way.

CAUTION

Exceeding generators wattage/amperage capacity can damage generator and/or electrical devices connected to it.

- See "Don't Overload Generator".
- Start generator and let engine stabilize before connecting electrical loads.
- Connect electrical loads in OFF position, then turn ON for operation.
- Turn electrical loads OFF and disconnect from generator before stopping generator.

CAUTION

Improper treatment of generator can damage it and shorten its life.

- Use generator only for intended uses.
- Operate generator only on level surfaces.
- DO NOT expose generator to excessive moisture, dust, dirt, or corrosive vapors.
- DO NOT insert any objects through cooling slots.
- If connected devices overheat, turn them off and disconnect them from generator.
- Shut off generator if:
 - electrical output is lost;
 - equipment sparks, smokes, or emits flames;
 - unit vibrates excessively.



KNOW YOUR GENERATOR - MODEL 030212

Read this owner's manual and safety rules before operating your generator.

Compare the illustrations with your generator, to familiarize yourself with the locations of various controls and adjustments. Save this manual for future reference.

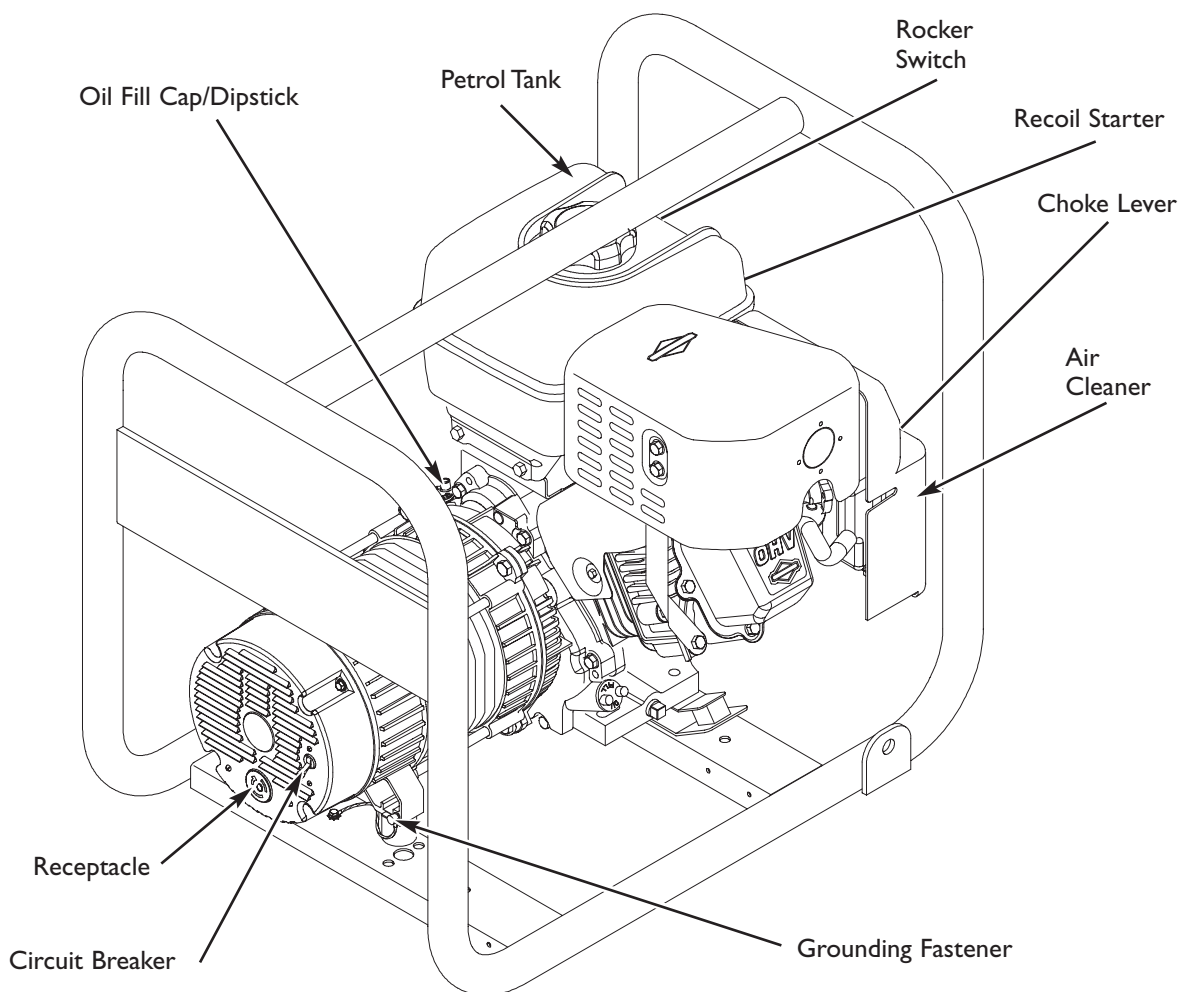

Air Cleaner — Protects engine by filtering dust and debris out of intake air

Circuit Breaker — Receptacle is protected against electrical overload with circuit breaker.

Petrol Tank — Capacity of 3.8l (1 U.S. gallon).

Grounding Fastener — If required, please consult a qualified electrician, electrical inspector, or the local agency having jurisdiction.

Oil Fill Cap/Dipstick — Check and fill engine with oil here.

Choke Lever — Used when starting a cold engine.

Receptacle — May be used to supply electrical power for the operation of various electrical, lighting, appliance, tool and motor loads.

Recoil Starter — Used for starting the engine.

Rocker Switch — Set switch to “On” prior to using recoil starter. Set switch to “Off” to switch off generator.



KNOW YOUR GENERATOR - MODEL 030213

Read this owner's manual and safety rules before operating your generator.

Compare the illustrations with your generator, to familiarize yourself with the locations of various controls and adjustments. Save this manual for future reference.

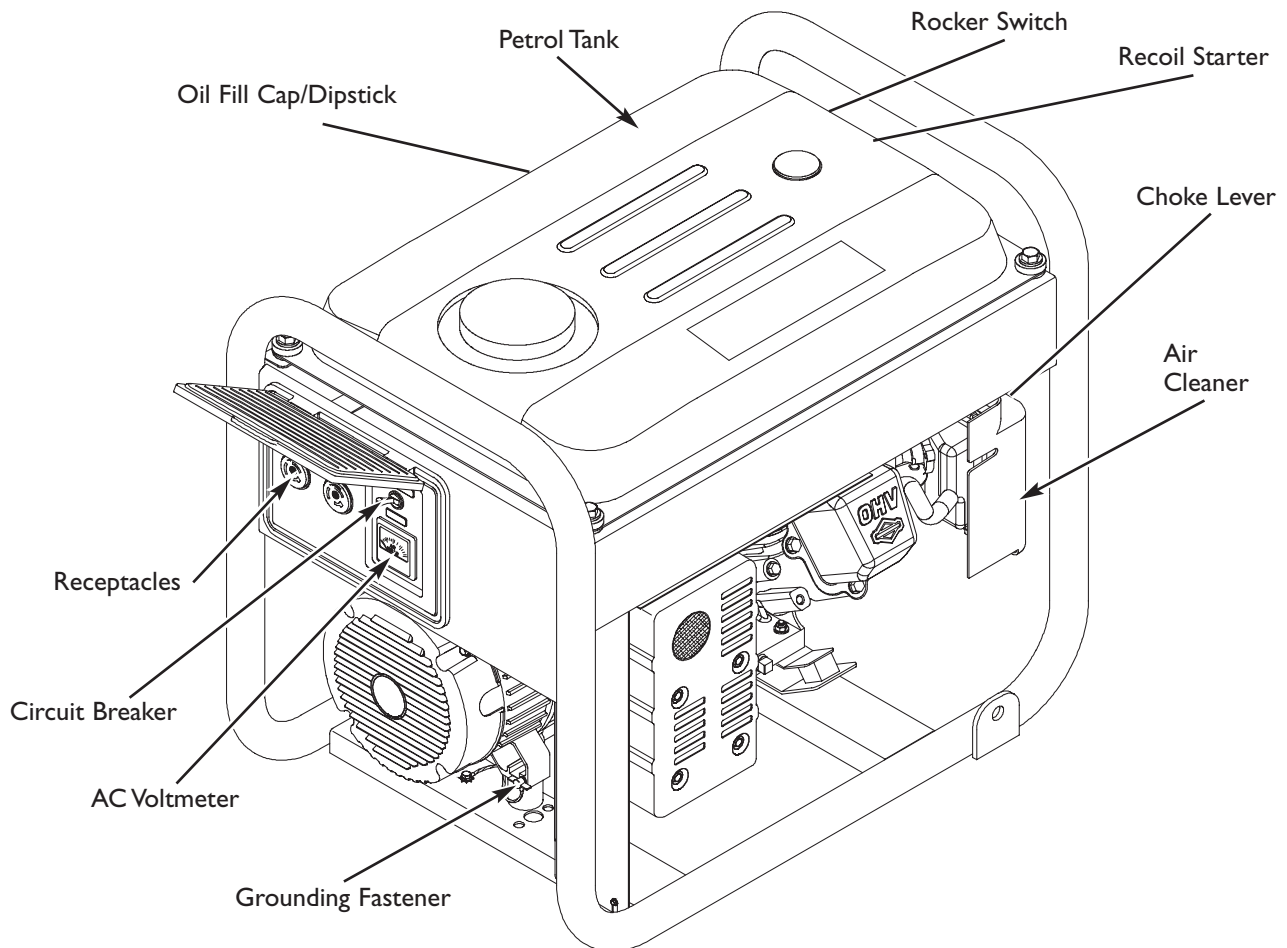

AC Voltmeter — Indicates output voltage.

Air Cleaner — Protects engine by filtering dust and debris out of intake air.

Circuit Breaker — Receptacle is protected against electrical overload with circuit breaker.

Petrol Tank — Capacity of 17 l (4.5 U.S. gallons).

Grounding Fastener — If required, please consult a qualified electrician, electrical inspector, or the local agency having jurisdiction.

Oil Fill Cap/Dipstick — Check and fill engine with oil here.

Choke Lever — Used when starting a cold engine.

Receptacles — May be used to supply electrical power for the operation of various electrical, lighting, appliance, tool and motor loads.

Recoil Starter — Used for starting the engine.

Rocker Switch — Set switch to "On" prior to using recoil starter. Set switch to "Off" to switch off generator.



ASSEMBLY

Your generator requires some assembly and is ready for use after it has been properly serviced with the recommended oil and petrol.

Remove Generator From Carton

1. Set carton on a rigid flat surface.
2. Carefully open top flaps of shipping carton.
3. Cut down corners of carton from top to bottom and lay sides of carton down flat.
4. Remove all packing material, carton fillers, etc.
5. Remove generator from shipping carton.

BEFORE STARTING THE ENGINE

Add Engine Oil

- Place generator on a level surface.

CAUTION

Any attempt to crank or start the engine before it has been properly filled with the recommended oil will result in equipment failure.

- Refer to engine manual for oil fill information.
- Damage to equipment resulting from failure to follow this instruction will void warranty.

- Refer to engine owner's manual and follow oil recommendations and instructions.

NOTE: Check oil often during engine break-in. Refer to engine owner's manual for recommendations.

NOTE: The generator assembly rotates on a prelubricated and sealed ball bearing that requires no additional lubrication for the life of the bearing.

Add Petrol

NOTE: This engine is certified to operate on petrol only. It will not operate on paraffin, diesel or other fuels.

WARNING



Petrol and its vapors are extremely flammable and explosive.



Fire or explosion can cause severe burns or death.

WHEN ADDING PETROL

- Turn generator OFF and let it cool at least 2 minutes before removing petrol cap. Loosen cap slowly to relieve pressure in tank.
- Fill petrol tank outdoors.
- DO NOT overfill tank. Allow space for petrol expansion.
- Keep petrol away from sparks, open flames, pilot lights, heat, and other ignition sources.
- DO NOT light a cigarette or smoke.

1. Use clean, fresh, regular UNLEADED petrol with a minimum of 85 octane. DO NOT use petrol which contains Methanol. DO NOT mix oil with petrol.
2. Clean area around petrol fill cap, remove cap.
- 3A. For model 030212, slowly add regular unleaded petrol to petrol tank. Be careful not to overfill. Allow about 4cm (1.5") of tank space for petrol expansion (Figure 1).

Figure 1 - Petrol Expansion Space

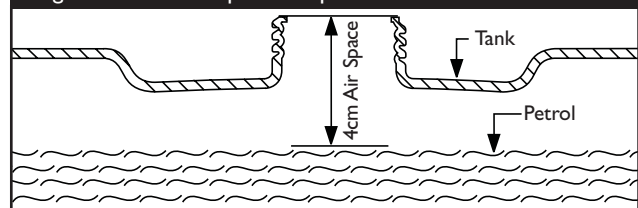

- 3B. For model 030213, slowly add regular unleaded petrol to petrol tank. Be careful not to fill above the baffle. This allows adequate space for petrol expansion (Figure 2).

Figure 2 — Petrol Expansion Space

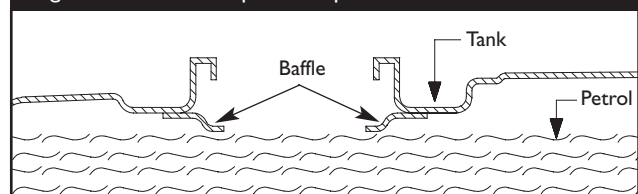

4. Install petrol cap and wipe up any spilled petrol.



USING THE GENERATOR

System Ground

The generator has a system ground that connects the generator frame components to the ground terminals on the AC output receptacles. The system ground is connected to the AC neutral wire (the neutral is bonded to the generator frame).

Special Requirements

There may be National regulations, local codes, or ordinances that apply to the intended use of the generator. Please consult a qualified electrician, electrical inspector, or the local agency having jurisdiction.

- In some areas, generators are required to be registered with local utility companies.
- If the generator is used at a construction site, there may be additional regulations which must be observed.

Connecting to a Building's Electrical System

Connections for standby power to a building's electrical system must be made by a qualified electrician. The connection must isolate the generator power from utility power, and must comply with all applicable laws and electrical codes.

WARNING



Generator produces powerful voltage. Failure to isolate generator from power utility can result in death or injury to electric utility workers due to backfeed of electrical energy.

- When using generator for backup power, notify utility company. Use approved transfer equipment to isolate generator from electric utility.
- Use a ground fault circuit interrupter (GFCI) in any damp or highly conductive area, such as metal decking or steel work.
- DO NOT touch bare wires or receptacles.
- DO NOT use generator with electrical cords which are worn, frayed, bare or otherwise damaged.
- DO NOT operate generator in the rain.
- DO NOT handle generator or electrical cords while standing in water, while barefoot, or while hands or feet are wet.
- DO NOT allow unqualified persons or children to operate or service generator.

Generator Location

Generator Clearance

WARNING



Running generator gives off carbon monoxide, an odorless, colorless, poison gas.

Breathing carbon monoxide will cause nausea, fainting or death.

- Operate generator **ONLY** outdoors.
- Keep exhaust gas from entering a confined area through windows, doors, ventilation intakes or other openings.
- **DO NOT** operate generator inside any building or enclosure, including the generator compartment of a recreational vehicle (RV).

The generator must be at least 2m (5 ft.) from structures having combustible walls and/or other combustible materials. Leave at least 1m (3 ft.) all around generator including overhead, for adequate cooling, maintenance and servicing.

Place generator in a well ventilated area, which will allow for removal of deadly exhaust gas. **DO NOT** place generator where exhaust gas could accumulate and enter inside or be drawn into a potentially occupied building. Ensure exhaust gas is kept away from any windows, doors, ventilation intakes or other openings that can allow exhaust gas to collect in a confined area (Figure 3). Prevailing winds and air currents should be taken into consideration when positioning generator.

Figure 3 — Generator Clearance

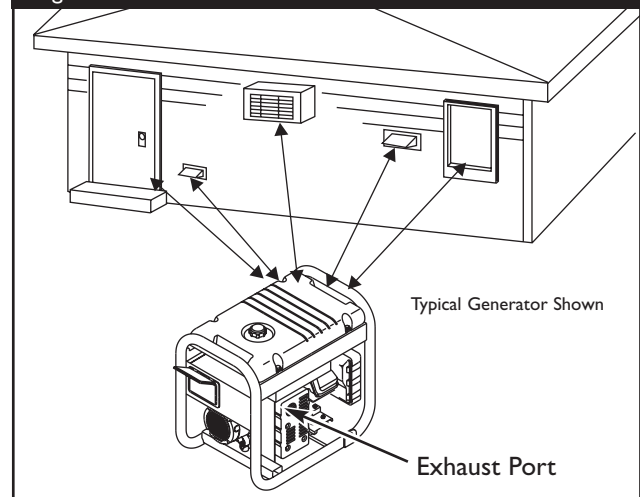



OPERATING THE GENERATOR

CAUTION

Exceeding generators wattage/amperage capacity can damage generator and/or electrical devices connected to it.

- See “Don’t Overload Generator”.
- Start generator and let engine stabilize before connecting electrical loads.
- Connect electrical loads in OFF position, then turn ON for operation.
- Turn electrical loads OFF and disconnect from generator before stopping generator.

Starting the Engine

Disconnect all electrical loads from the generator. Use the following start instructions:

1. Make sure unit is on a level surface.

IMPORTANT: Failure to start and operate unit on a level surface will cause the unit not to start or shut down during operation.

2. Turn petrol valve to “On” position (Figure 4).

Figure 4 — Petrol Valve

Petrol Valve is shown in “On” position

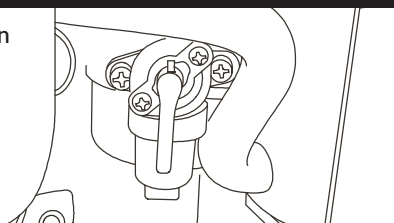

3. Start engine according to instructions given in engine owner’s manual.

WARNING



Rapid retraction of starter cord (kickback) will pull hand and arm toward engine faster than you can let go.

Broken bones, fractures, bruises or sprains could result.

- When starting engine, pull cord slowly until resistance is felt and then pull rapidly to avoid kickback.
- NEVER start or stop engine with electrical devices plugged in and turned on.

NOTE: If engine starts after 3 pulls but fails to run, or if unit shuts down during operation, make sure unit is on a level surface and check for proper oil level in crankcase. This unit may be equipped with a low oil protection device. See engine manual.

WARNING



Running engines produce heat. Temperature of muffler and nearby areas can reach or exceed 65°C (150°F).



Severe burns can occur on contact. Combustible debris, such as leaves, grass, brush, ect. can catch fire.

- DO NOT touch hot surfaces.
- Allow equipment to cool before touching.
- The generator must be at least 2m (5 ft) from structures having combustible walls and/or other combustible materials.
- Keep at least 1m (3 ft) of clearance on all sides of generator for adequate cooling, maintenance and servicing.

Connecting Electrical Loads

- Let engine stabilize and warm up for a few minutes after starting.
- Plug in and turn on the desired 230 Volt AC, single phase, 50 Hz electrical loads.
- DO NOT connect 3-phase loads to the generator.
- DO NOT connect 60 Hz loads to the generator.
- **DO NOT OVERLOAD THE GENERATOR.** See “Don’t Overload Generator”.

Stopping the Engine

1. Turn OFF and unplug **all** electrical loads from generator panel receptacles. NEVER start or stop engine with electrical devices plugged in and turned ON.
2. Let engine run at no-load for several minutes to stabilize internal temperatures of engine and generator.
3. Turn engine off according to instructions given in the engine owner’s manual.
4. Move petrol valve to “Off” position.



RECEPTACLES

CAUTION

Receptacles may be marked with rating value greater than generator output capacity.

- NEVER attempt to power a device requiring more amperage than generator or receptacle can supply.
- DO NOT overload the generator. See “Don’t Overload Generator”.

AC Voltmeter (Model 030213 Only)

Use the voltmeter as a visual aid. It indicates AC voltage. If the meter indicates that AC output voltage is far below 230 Volts, engine speed or frequency may be too low.

Circuit Breaker

The model 030212 circuit breaker is rated at 10 Amps. The model 030213 circuit breaker is rated at 15 Amps. This circuit breaker, when tripped, will cut off power to all 230 Volt outlets. To reset the breaker, set the switch to the “On” position. When the switch is in the “Off” position the engine may be running but no power is supplied to the outlets.

230 Volt AC, 20 Amp, Locking Receptacle

Use a compatible 3 prong plug with this receptacle (Figure 5). Connect a 3-wire cord set rated 250 volts at 20 AC Amps to the plug.

Figure 5 — 230 Volt AC, 20 Amp Receptacle

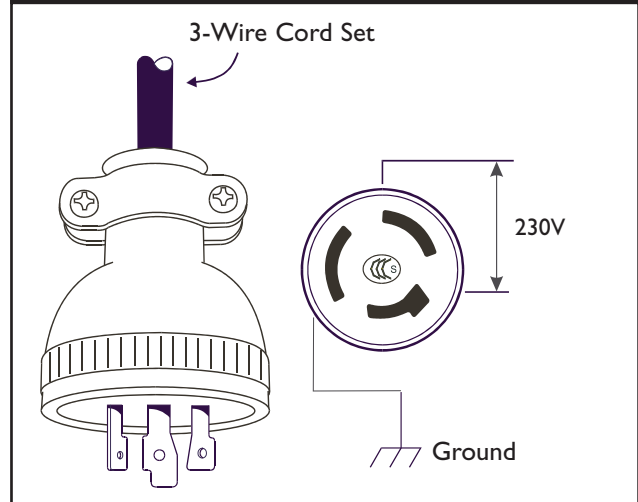

For model 030212, this receptacle powers 230 Volt AC, 50 Hz, single phase loads requiring up to 2,500 Watts of power (2.5 kW) at 10 Amps for 230 Volts.

For model 030213, these receptacles power 230 Volt AC, 50 Hz, single phase loads requiring up to 2,800 Watts of power (2.8 kW) at 12.1 Amps for 230 Volts total.

COLD WEATHER OPERATION

Under certain weather conditions (temperatures below 40°F [4°C] combined with high humidity), your generator may experience icing of the carburetor and/or the crankcase breather system. To reduce this problem, you need to perform the following:

1. Make sure generator has clean, fresh petrol.
2. Open petrol valve (turn valve to open position).
3. Use SAE 5W-30 oil (synthetic preferred, see engine manual).
4. Check oil level daily or after every eight (8) hours of operation.
5. Maintain generator following “Maintenance Schedule” in engine manual.
6. Shelter unit from elements.



DON'T OVERLOAD GENERATOR

Capacity

You must make sure your generator can supply enough rated (running) and surge (starting) watts for the items you will power at the same time. Follow these simple steps:

1. Select the items you will power at the same time.
2. Total the rated (running) watts of these items. See Figure 6.
3. Estimate how many surge (starting) watts you will need. Surge wattage is the short burst of power needed to start electric motor-driven tools or appliances. Total surge watts is estimated by adding only the one item with the highest additional surge watts to the total rated watts from step 2.

For Example:

Tool or Appliance	Rated (Running) Watts	Additional Surge (Starting) Watts
Refrigerator	800	1600
Deep Freezer	500	500
Television	500	-
Light (75 Watts)	75	-
	1875 Total Running Watts	1600 Highest Surge Watts

Total Rated (Running) Watts = 1875

Highest Additional Surge Watts = 1600

Total Generator Output Required = 3475

Power Management

It is important to take care when adding electrical loads to your generator. The correct and safe way to manage generator power is to sequentially add loads as follows:

1. With nothing connected to the generator, start the engine as described in this manual.
2. Plug in and turn on the first load, preferably the largest load you have.
3. Permit the generator output to stabilize (engine runs smoothly and attached device operates properly).

4. Plug in and turn on the next load.
5. Again, permit the generator to stabilize.
6. Repeat steps 4 and 5 for each additional load.

NEVER add more loads than generator capacity. Take special care to consider surge loads in generator capacity, as described above.

Figure 6 - Wattage Reference Chart

Tool or Appliance	Rated* (Running) Watts	Additional Surge (Starting) Watts
Essentials		
Light Bulb - 75 watt	75	-
Deep Freezer	500	500
Sump Pump	800	1200
Refrigerator/Freezer - 18 Cu. Ft.	800	1600
Water Well Pump - 1/3 HP	1000	2000
Heating/Cooling		
Window Fan	300	600
Furnace Fan Blower - 1/2 HP	800	1300
Kitchen		
Microwave Oven - 1000 Watt	1000	-
Coffee Maker	1500	-
Electric Stove - Single Element	1500	-
Hot Plate	2500	-
Family Room		
Stereo Receiver	450	-
Television - 27"	500	-
Personal Computer w/17" monitor	800	-
Other		
AM/FM Clock Radio	300	-
Electric Water Heater - 40 Gallon	4000	-
Quartz Halogen Work Light	1000	-
Airless Sprayer - 1/3 HP	600	1200
Reciprocating Saw	960	960
Electric Drill - 1/2 HP	1000	1000
Circular Saw - 7 1/4"	1500	1500
Miter Saw - 10"	1800	1800
Table Saw/Radial Arm Saw - 10"	2000	2000
Air Compressor - 1-1/2 HP	2500	2500

*Wattages listed are approximate only. Check tool or appliance for actual wattage.



SPECIFICATIONS

Model 030212

Maximum Surge Watts3,250 watts
 Continuous Wattage Capacity2,500 watts
 Power Factor1.0
 Rated Maximum Continuous AC Load Current:
 At 230 Volts10 Amps
 Phase1-phase
 Rated Frequency50 Hertz
 Petrol Tank Capacity 3.78 l (1 U.S. gallons)
 Shipping Weight 33.6 kg (74 lbs.)

Model 030213

Maximum Surge Watts4,200 watts
 Continuous Wattage Capacity2,800 watts
 Power Factor1.0
 Rated Maximum Continuous AC Load Current:
 At 230 Volts12.1 Amps
 Phase1-phase
 Rated Frequency50 Hertz
 Petrol Tank Capacity 17 l (4.5 U.S. gallons)
 Shipping Weight 40 kg (88 lbs.)

GENERAL MAINTENANCE RECOMMENDATIONS

The Owner/Operator is responsible for making sure that all periodic maintenance tasks are completed on a timely basis; that all discrepancies are corrected; and that the unit is kept clean and properly stored. **NEVER operate a damaged or defective generator.**

Engine Maintenance

See engine owner’s manual for instructions.

 CAUTION
Avoid prolonged or repeated skin contact with used motor oil.
<ul style="list-style-type: none"> • Used motor oil has been shown to cause skin cancer in certain laboratory animals. • Thoroughly wash exposed areas with soap and water.





KEEP OUT OF REACH OF CHILDREN.
 DON'T POLLUTE. CONSERVE RESOURCES.
 RETURN USED OIL TO COLLECTION CENTERS.

Generator Maintenance

Generator maintenance consists of keeping the unit clean and dry. Operate and store the unit in a clean dry environment where it will not be exposed to excessive dust, dirt, moisture or any corrosive vapors. Cooling air slots in the generator must not become clogged with snow, leaves or any other foreign material.

NOTE: DO NOT use a garden hose to clean generator. Water can enter engine petrol system and cause problems. In addition, if water enters generator through cooling air slots, some of the water will be retained in voids and cracks of the rotor and stator winding insulation. Water and dirt buildup on the generator internal windings will eventually decrease the insulation resistance of these windings.

 WARNING	
	Unintentional sparking can result in fire or electric shock.
	
WHEN ADJUSTING OR MAKING REPAIRS TO YOUR GENERATOR	
<ul style="list-style-type: none"> • Disconnect the spark plug wire from the spark plug and place the wire where it cannot contact spark plug. 	
WHEN TESTING FOR ENGINE SPARK	
<ul style="list-style-type: none"> • Use approved spark plug tester. • DO NOT check for spark with spark plug removed. 	

Generator Cleaning

- Use a damp cloth to wipe exterior surfaces clean.

CAUTION	
Improper treatment of generator can damage it and shorten its life.	
<ul style="list-style-type: none"> • DO NOT expose generator to excessive moisture, dust, dirt, or corrosive vapors. • DO NOT insert any objects through cooling slots. 	
<ul style="list-style-type: none"> • Use a soft bristle brush to loosen caked on dirt or oil. • Use a vacuum cleaner to pick up loose dirt and debris. • Use low pressure air (not to exceed 25 psi) to blow away dirt. Inspect cooling air slots and opening on generator. These openings must be kept clean and unobstructed. 	



STORAGE

The generator should be started at least once every seven days and allowed to run at least 30 minutes. If this cannot be done and you must store the unit for more than 30 days, use the following guidelines to prepare it for storage.

Generator Storage

- Clean the generator as outlined in “Generator Cleaning”.
- Check that cooling air slots and openings on generator are open and unobstructed.



WARNING

Storage covers can be flammable.

- DO NOT place a storage cover over a hot generator.
- Let equipment cool for a sufficient time before placing the cover on the equipment.

Engine Storage

See engine owner's manual for instructions.

Other Storage Tips

- To prevent gum from forming in petrol system or on essential carburetor parts, add petrol stabilizer into petrol tank and fill with fresh petrol. Run the unit for several minutes to circulate the additive through the carburetor. The unit and petrol can then be stored for up to 24 months. Petrol stabilizer can be purchased locally.
- DO NOT store petrol from one season to another unless it has been treated as described above.
- Replace petrol container if it starts to rust. Rust and/or dirt in petrol can cause problems if it's used with this unit.
- Store unit in a clean and dry area.



TROUBLESHOOTING

Problem	Cause	Solution
Engine is running, but no AC output is available.	<ol style="list-style-type: none">1. Circuit breaker is open.2. Poor connection or defective cord set.3. Connected device is bad.4. Fault in generator.	<ol style="list-style-type: none">1. Reset circuit breaker.2. Check and repair.3. Connect another device that is in good condition.4. Contact Briggs and Stratton service facility.
Engine runs good but bogs down when loads are connected.	<ol style="list-style-type: none">1. Short circuit in a connected load.2. Generator is overloaded.3. Shorted generator circuit.	<ol style="list-style-type: none">1. Disconnect shorted electrical load.2. See "Don't Overload Generator".3. Contact Briggs and Stratton service facility.
Engine will not start; or starts and runs rough.	<ol style="list-style-type: none">1. Out of petrol.2. Petrol valve is in the "Closed" position.3. Low oil level.	<ol style="list-style-type: none">1. Fill petrol tank.2. Turn petrol valve to the "Open" position.3. Fill crankcase to proper level.
Engine shuts down during operation.	<ol style="list-style-type: none">1. Out of petrol.2. Low oil level.3. Generator tipped at angle.	<ol style="list-style-type: none">1. Fill petrol tank.2. Fill crankcase to proper level.3. Place generator on level surface.
Engine lacks power.	Load is too high.	See "Don't Overload Generator".

NOTES



NOTES

BRIGGS & STRATTON POWER PRODUCTS GROUP, LLC EQUIPMENT OWNER WARRANTY POLICY

Effective September 1, 2004 replaces all undated Warranties and all Warranties dated before September 1, 2004

LIMITED WARRANTY

Briggs & Stratton Power Products Group, LLC will repair or replace, free of charge, any part(s) of the equipment that is defective in material or workmanship or both. Transportation charges on parts submitted for repair or replacement under this warranty must be borne by purchaser. This warranty is effective for the time periods and subject to the conditions stated below. For warranty service, find the nearest Authorized Service Dealer in our dealer locator at www.briggspowerproducts.com.

THERE IS NO OTHER EXPRESS WARRANTY. IMPLIED WARRANTIES, INCLUDING THOSE OF MERCHANTABILITY AND FITNESS FOR A PARTICULAR PURPOSE, ARE LIMITED TO ONE YEAR FROM PURCHASE, OR TO THE EXTENT PERMITTED BY LAW ANY AND ALL IMPLIED WARRANTIES ARE EXCLUDED. LIABILITY FOR INCIDENTAL OR CONSEQUENTIAL DAMAGES ARE EXCLUDED TO THE EXTENT EXCLUSION IS PERMITTED BY LAW. Some states or countries do not allow limitations on how long an implied warranty lasts, and some states or countries do not allow the exclusion or limitation of incidental or consequential damages, so the above limitation and exclusion may not apply to you. This warranty gives you specific legal rights and you may also have other rights which vary from state to state or country to country.

OUR EQUIPMENT*

OUTBOARD MOTOR	PRESSURE WASHER	WATER PUMP	PORTABLE GENERATOR WELDER	HOME STANDBY GENERATOR SYSTEM		
				Less than 10 KW	10 KW or greater	Transfer switch

WARRANTY PERIOD**

	OUTBOARD MOTOR	PRESSURE WASHER	WATER PUMP	PORTABLE GENERATOR WELDER	HOME STANDBY GENERATOR SYSTEM Less than 10 KW	HOME STANDBY GENERATOR SYSTEM 10 KW or greater	HOME STANDBY GENERATOR SYSTEM Transfer switch
Consumer Use	2 years	1 year	1 year	2 years	2 years	3 years or 1500 hours	3 years
Commercial Use	none	90 days	90 days	1 year	none	none	none

* The engine and starting batteries are warranted solely by the manufacturers of those products.

** 2 years for all consumer products in the European Union. Parts only on 2nd year for consumer use of Portable Generator and Home Standby Generator System - Less than 10 KW, outside of European Union.

The warranty period begins on the date of purchase by the first retail consumer or commercial end user, and continues for the period of time stated in the table above. "Consumer use" means personal residential household use by a retail consumer. "Commercial use" means all other uses, including use for commercial, income producing or rental purposes. Once equipment has experienced commercial use, it shall thereafter be considered as commercial use for purposes of this warranty. **Equipment used for prime power in place of utility are not applicable to this warranty. Electric powered pressure washers used for commercial purposes are not warranted.**

NO WARRANTY REGISTRATION IS NECESSARY TO OBTAIN WARRANTY ON BRIGGS & STRATTON PRODUCTS. SAVE YOUR PROOF OF PURCHASE RECEIPT. IF YOU DO NOT PROVIDE PROOF OF THE INITIAL PURCHASE DATE AT THE TIME WARRANTY SERVICE IS REQUESTED, THE MANUFACTURING DATE OF THE PRODUCT WILL BE USED TO DETERMINE THE WARRANTY PERIOD.

ABOUT YOUR WARRANTY

We welcome warranty repair and apologize to you for being inconvenienced. Any Authorized Service Dealer may perform warranty repairs. Most warranty repairs are handled routinely, but sometimes requests for warranty service may not be appropriate. For example, warranty service would not apply if equipment damage occurred because of misuse, lack of routine maintenance, shipping, handling, warehousing or improper installation. Similarly, the warranty is void if the manufacturing date or the serial number on the equipment has been removed or the equipment has been altered or modified. During the warranty period, the Authorized Service Dealer, at its option, will repair or replace any part that, upon examination, is found to be defective under normal use and service. This warranty will not cover the following repairs and equipment:

- **Normal Wear:** Outdoor Power Equipment, like all mechanical devices, needs periodic parts and service to perform well. This warranty does not cover repair when normal use has exhausted the life of a part or the equipment.
- **Installation and Maintenance:** This warranty does not apply to equipment or parts that have been subjected to improper or unauthorized installation or alteration and modification, misuse, negligence, accident, overloading, overspeeding, improper maintenance, repair or storage so as, in our judgment, to adversely affect its performance and reliability. This warranty also does not cover normal maintenance such as adjustments, fuel system cleaning and obstruction (due to chemical, dirt, carbon, lime, etc.).
- **Other Exclusions:** This warranty excludes wear items such as quick couplers, oil gauges, belts, o-rings, filters, pump packing, etc., pumps that have been run without water supplied or damage or malfunctions resulting from accidents, abuse, modifications, alterations, or improper servicing or freezing or chemical deterioration. Accessory parts such as guns, hoses, wands and nozzles are excluded from the product warranty. This warranty excludes failures due to acts of God and other force majeure events beyond the manufacturers control. Also excluded is used, reconditioned, and demonstration equipment; equipment used for prime power in place of utility power and equipment used in life support applications.

BRIGGS & STRATTON POWER PRODUCTS GROUP, LLC
JEFFERSON, WI, USA