

14" Wood Cutting Band Saw (Models 28-241 & 28-299A)



426-02-651-0049 - 06-24-02
Copyright © 2002 Delta Machinery

INSTRUCTION MANUAL



To learn more about DELTA MACHINERY
visit our website at: www.deltamachinery.com.

For Parts, Service, Warranty or other Assistance,

please call 1-800-223-7278 (In Canada call 1-800-463-3582).

GENERAL SAFETY RULES

Woodworking can be dangerous if safe and proper operating procedures are not followed. As with all machinery, there are certain hazards involved with the operation of the product. Using the machine with respect and caution will considerably lessen the possibility of personal injury. However, if normal safety precautions are overlooked or ignored, personal injury to the operator may result. Safety equipment such as guards, push sticks, hold-downs, featherboards, goggles, dust masks and hearing protection can reduce your potential for injury. But even the best guard won't make up for poor judgment, carelessness or inattention. Always use common sense and exercise caution in the workshop. If a procedure feels dangerous, don't try it. Figure out an alternative procedure that feels safer. **REMEMBER:** Your personal safety is your responsibility.

This machine was designed for certain applications only. Delta Machinery strongly recommends that this machine not be modified and/or used for any application other than that for which it was designed. If you have any questions relative to a particular application, **DO NOT** use the machine until you have first contacted Delta to determine if it can or should be performed on the product.

Technical Service Manager
Delta Machinery
4825 Highway 45 North
Jackson, TN 38305

(IN CANADA: 505 SOUTHGATE DRIVE, GUELPH, ONTARIO N1H 6M7)



WARNING: FAILURE TO FOLLOW THESE RULES MAY RESULT IN SERIOUS PERSONAL INJURY

1. **FOR YOUR OWN SAFETY, READ INSTRUCTION MANUAL BEFORE OPERATING THE TOOL.** Learn the tool's application and limitations as well as the specific hazards peculiar to it.

2. **KEEP GUARDS IN PLACE** and in working order.

3. **ALWAYS WEAR EYE PROTECTION.** Wear safety glasses. Everyday eyeglasses only have impact resistant lenses; they are not safety glasses. Also use face or dust mask if cutting operation is dusty. These safety glasses must conform to ANSI Z87.1 requirements. **NOTE:** Approved glasses have Z87 printed or stamped on them.

4. **REMOVE ADJUSTING KEYS AND WRENCHES.** Form habit of checking to see that keys and adjusting wrenches are removed from tool before turning it "on".

5. **KEEP WORK AREA CLEAN.** Cluttered areas and benches invite accidents.

6. **DON'T USE IN DANGEROUS ENVIRONMENT.** Don't use power tools in damp or wet locations, or expose them to rain. Keep work area well-lighted.

7. **KEEP CHILDREN AND VISITORS AWAY.** All children and visitors should be kept a safe distance from work area.

8. **MAKE WORKSHOP CHILDPROOF** – with padlocks, master switches, or by removing starter keys.

9. **DON'T FORCE TOOL.** It will do the job better and be safer at the rate for which it was designed.

10. **USE RIGHT TOOL.** Don't force tool or attachment to do a job for which it was not designed.

11. **WEAR PROPER APPAREL.** No loose clothing, gloves, neckties, rings, bracelets, or other jewelry to get caught in moving parts. Nonslip footwear is recommended. Wear protective hair covering to contain long hair.

12. **SECURE WORK.** Use clamps or a vise to hold work when practical. It's safer than using your hand and frees both hands to operate tool.

13. **DON'T OVERREACH.** Keep proper footing and balance at all times.

14. **MAINTAIN TOOLS IN TOP CONDITION.** Keep tools sharp and clean for best and safest performance. Follow instructions for lubricating and changing accessories.

15. **DISCONNECT TOOLS** before servicing and when changing accessories such as blades, bits, cutters, etc.

16. **USE RECOMMENDED ACCESSORIES.** The use of accessories and attachments not recommended by Delta may cause hazards or risk of injury to persons.

17. **REDUCE THE RISK OF UNINTENTIONAL STARTING.** Make sure switch is in "OFF" position before plugging in power cord. In the event of a power failure, move switch to the "OFF" position.

18. **NEVER STAND ON TOOL.** Serious injury could occur if the tool is tipped or if the cutting tool is accidentally contacted.

19. **CHECK DAMAGED PARTS.** Before further use of the tool, a guard or other part that is damaged should be carefully checked to ensure that it will operate properly and perform its intended function – check for alignment of moving parts, binding of moving parts, breakage of parts, mounting, and any other conditions that may affect its operation. A guard or other part that is damaged should be properly repaired or replaced.

20. **DIRECTION OF FEED.** Feed work into a blade or cutter against the direction of rotation of the blade or cutter only.

21. **NEVER LEAVE TOOL RUNNING UNATTENDED. TURN POWER OFF.** Don't leave tool until it comes to a complete stop.

22. **STAY ALERT, WATCH WHAT YOU ARE DOING, AND USE COMMON SENSE WHEN OPERATING A POWER TOOL. DO NOT USE TOOL WHILE TIRED OR UNDER THE INFLUENCE OF DRUGS, ALCOHOL, OR MEDICATION.** A moment of inattention while operating power tools may result in serious personal injury.

23. **MAKE SURE TOOL IS DISCONNECTED FROM POWER SUPPLY** while motor is being mounted, connected or reconnected.

24. **THE DUST GENERATED** by certain woods and wood products can be injurious to your health. Always operate machinery in well ventilated areas and provide for proper dust removal. Use wood dust collection systems whenever possible.

25.  **WARNING: SOME DUST CREATED BY POWER SANDING, SAWING, GRINDING, DRILLING, AND OTHER CONSTRUCTION ACTIVITIES** contains chemicals known to cause cancer, birth defects or other reproductive harm. Some examples of these chemicals are:

- lead from lead-based paints,
 - crystalline silica from bricks and cement and other masonry products, and
 - arsenic and chromium from chemically-treated lumber.
- Your risk from these exposures varies, depending on how often you do this type of work. To reduce your exposure to these chemicals: work in a well ventilated area, and work with approved safety equipment, such as those dust masks that are specially designed to filter out microscopic particles.

ADDITIONAL SAFETY RULES FOR BAND SAWS



WARNING: FAILURE TO FOLLOW THESE RULES MAY RESULT IN SERIOUS PERSONAL INJURY.

1. **DO NOT OPERATE THIS MACHINE UNTIL** it is **assembled** and **installed** according to the instructions.
2. **OBTAIN ADVICE** from your **supervisor, instructor, or another qualified person** if you are not familiar with the operation of this tool.
3. **FOLLOW ALL WIRING CODES** and recommended electrical connections.
4. **USE THE GUARDS WHENEVER POSSIBLE.** Check to see that they are in place, secured, and working correctly.
5. **USE PROPER BLADE SIZE** and type.
6. **ADJUST THE UPPER BLADE GUIDE** so that it is about 1/8" above the workpiece.
7. **PROPERLY ADJUST** the blade tension, tracking, blade guides, and blade support bearings.
8. **KEEP ARMS, HANDS, AND FINGERS** away from the blade.
9. **AVOID AWKWARD OPERATIONS** and hand positions where a sudden slip could cause a hand to move into the blade.
10. **NEVER START THE MACHINE** before clearing the table of all objects (tools, scrap pieces, etc.).
11. **NEVER START THE MACHINE** with the workpiece against the blade.
12. **HOLD WORKPIECE FIRMLY** against the table. **DO NOT** attempt to saw a workpiece that does not have a flat surface against the table.
13. **HOLD WORKPIECE FIRMLY** and feed into blade at a moderate speed.
14. **NEVER REACH UNDER THE TABLE** while the machine is running.
15. **TURN THE MACHINE "OFF"** to back out of an uncompleted or jammed cut.
16. **MAKE "RELIEF" CUTS** prior to cutting long curves.
17. **TURN THE MACHINE "OFF"** and wait for the blade to stop prior to cleaning the blade area, removing debris near the blade, removing or securing workpiece, or changing the angle of the table. A coasting blade can be dangerous.
18. **PROPERLY SUPPORT LONG OR WIDE work pieces.**
19. **NEVER PERFORM LAYOUT, ASSEMBLY,** or set-up work on the table/work area when the machine is running.
20. **TURN THE MACHINE "OFF" AND DISCONNECT THE MACHINE** from the power source before installing or removing accessories, before adjusting or changing set-ups, or when making repairs.
21. **TURN THE MACHINE "OFF"**, disconnect the machine from the power source, and clean the table/work area before leaving the machine. **LOCK THE SWITCH IN THE "OFF" POSITION** to prevent unauthorized use.
22. **ADDITIONAL INFORMATION** regarding the safe and proper operation of this tool is available from the Power Tool Institute, 1300 Summer Avenue, Cleveland, OH 44115-2851. Information is also available from the National Safety Council, 1121 Spring Lake Drive, Itasca, IL 60143-3201. Please refer to the American National Standards Institute ANSI 01.1 Safety Requirements for Woodworking Machines and the U.S. Department of Labor OSHA 1910.213 Regulations.

SAVE THESE INSTRUCTIONS.

Refer to them often

and use them to instruct others.

POWER CONNECTIONS

A separate electrical circuit should be used for your machines. This circuit should not be less than #12 wire and should be protected with a 20 Amp time lag fuse. If an extension cord is used, use only 3-wire extension cords which have 3-prong grounding type plugs and matching receptacle which will accept the machine's plug. Before connecting the motor to the power line, make sure the switch is in the "OFF" position and be sure that the electric current is of the same characteristics as indicated on the machine. All line connections should make good contact. Running on low voltage will damage the motor.

⚠ WARNING: DO NOT EXPOSE THE MACHINE TO RAIN OR OPERATE THE MACHINE IN DAMP LOCATIONS.

MOTOR SPECIFICATIONS

Your machine is wired for 120 volt, 60 HZ alternating current. **Before connecting the machine to the power source, make sure the switch is in the "OFF" position.**

GROUNDING INSTRUCTIONS

⚠ WARNING: THIS MACHINE MUST BE GROUNDED WHILE IN USE TO PROTECT THE OPERATOR FROM ELECTRIC SHOCK.

1. All grounded, cord-connected machines:

In the event of a malfunction or breakdown, grounding provides a path of least resistance for electric current to reduce the risk of electric shock. This machine is equipped with an electric cord having an equipment-grounding conductor and a grounding plug. The plug must be plugged into a matching outlet that is properly installed and grounded in accordance with all local codes and ordinances.

Do not modify the plug provided - if it will not fit the outlet, have the proper outlet installed by a qualified electrician.

Improper connection of the equipment-grounding conductor can result in risk of electric shock. The conductor with insulation having an outer surface that is green with or without yellow stripes is the equipment-grounding conductor. If repair or replacement of the electric cord or plug is necessary, do not connect the equipment-grounding conductor to a live terminal.

Check with a qualified electrician or service personnel if the grounding instructions are not completely understood, or if in doubt as to whether the machine is properly grounded.

Use only 3-wire extension cords that have 3-prong grounding type plugs and matching 3-conductor receptacles that accept the machine's plug, as shown in Fig. A.

Repair or replace damaged or worn cord immediately.

2. Grounded, cord-connected machines intended for use on a supply circuit having a nominal rating less than 150 volts:

If the machine is intended for use on a circuit that has an outlet that looks like the one illustrated in Fig. A, the machine will have a grounding plug that looks like the plug illustrated in Fig. A. A temporary adapter, which looks like the adapter illustrated in Fig. B, may be used to connect this plug to a matching 2-conductor receptacle as shown in Fig. B if a properly grounded outlet is not available. The temporary adapter should be used only until a properly grounded outlet can be installed by a qualified electrician. The green-colored rigid ear, lug, and the like, extending from the adapter must be connected to a permanent ground such as a properly grounded outlet box. Whenever the adapter is used, it must be held in place with a metal screw.

NOTE: In Canada, the use of a temporary adapter is not permitted by the Canadian Electric Code.

⚠ WARNING: IN ALL CASES, MAKE CERTAIN THE RECEPTACLE IN QUESTION IS PROPERLY GROUNDED. IF YOU ARE NOT SURE HAVE A QUALIFIED ELECTRICIAN CHECK THE RECEPTACLE.

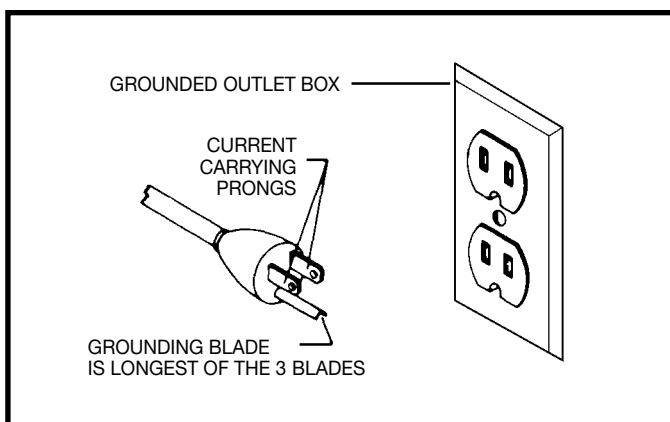

Fig. A

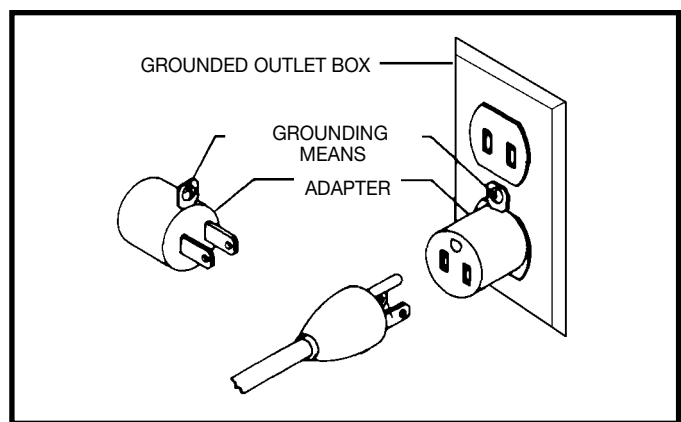

Fig. B

EXTENSION CORDS

Use proper extension cords. Make sure your extension cord is in good condition and is a 3-wire extension cord which has a 3-prong grounding type plug and matching receptacle which will accept the machine's plug. When using an extension cord, be sure to use one heavy enough to carry the current of the machine. An undersized cord will cause a drop in line voltage, resulting in loss of power and overheating. Fig. D, shows the correct gauge to use depending on the cord length. If in doubt, use the next heavier gauge. The smaller the gauge number, the heavier the cord.

MINIMUM GAUGE EXTENSION CORD			
RECOMMENDED SIZES FOR USE WITH STATIONARY ELECTRIC MACHINES			
Ampere Rating	Volts	Total Length of Cord in Feet	Gauge of Extension Cord
0-6	120	up to 25	18 AWG
0-6	120	25-50	16 AWG
0-6	120	50-100	16 AWG
0-6	120	100-150	14 AWG
6-10	120	up to 25	18 AWG
6-10	120	25-50	16 AWG
6-10	120	50-100	14 AWG
6-10	120	100-150	12 AWG
10-12	120	up to 25	16 AWG
10-12	120	25-50	16 AWG
10-12	120	50-100	14 AWG
10-12	120	100-150	12 AWG
12-16	120	up to 25	14 AWG
12-16	120	25-50	12 AWG
12-16	120	GREATER THAN 50 FEET NOT RECOMMENDED	

Fig. D

OPERATING INSTRUCTIONS

FOREWORD

Delta Models 28-241 and 28-299A are 14" Band Saws, equipped with a 1-1/2 HP, 120V guarded, drip-proof motor inside an enclosed stand. Included with each saw is a push button switch, a blade and belt guard, an arbor and motor pulleys with a V-belt, blade guides, a wood cutting blade, and an instruction manual.

UNPACKING AND CLEANING

Carefully unpack the machine and all loose items from the shipping container(s). Remove the protective coating from all unpainted surfaces. This coating may be removed with a soft cloth moistened with kerosene (do not use acetone, gasoline or lacquer thinner for this purpose). After cleaning, cover the unpainted surfaces with a good quality household floor paste wax.

NOTICE: THE MANUAL COVER PHOTO ILLUSTRATES THE CURRENT PRODUCTION MODEL. ALL OTHER ILLUSTRATIONS ARE REPRESENTATIVE ONLY AND MAY NOT DEPICT THE ACTUAL COLOR, LABELING OR ACCESSORIES AND MAY BE INTENDED TO ILLUSTRATE TECHNIQUE ONLY.

ASSEMBLY

STAND

The stand is shipped top-down in the shipping container with the motor mounted to the inside top of the stand. The on/off switch is wired to the end of the power cord.

To make the motor operational, do the following:

1. Remove the stand (A) Fig. 4 from the shipping container.

NOTE: Set the stand on several blocks of wood to raise the stand off the floor.

2. Take the panel (B) Fig. 4 off of the stand (A) by removing two screws (C) and loosening the two other screws (D). Remove the panel on the opposite side of the stand in the same way.

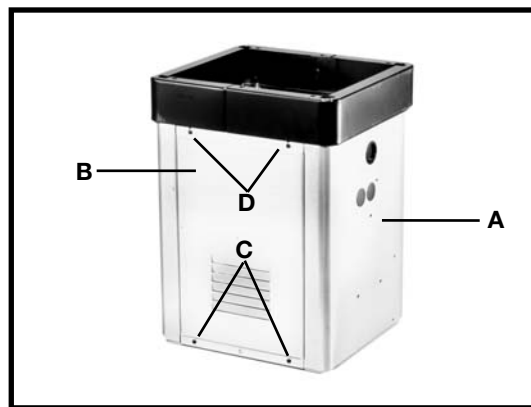

Fig. 4

3. Remove the two mounting screws that are holding the motor (F) Fig. 5 to the top of the stand. One screw is shown at (E) Fig. 5.

4. Remove motor from stand.



Fig. 5

ATTACHING MOTOR TO STAND

1. Turn the stand on its side with the two bars (B) Fig. 6 down.

2. Position the motor (C) Fig. 6 on the two horizontal support bars (B), and fasten with the four 5/16x18 carriage bolts and flange nuts, three of which are shown at (F). **IMPORTANT: PLACE THE MOTOR SHAFT (E) ON THE SAME SIDE OF THE STAND AS THE LARGE OPENING AT THE TOP OF THE STAND (SEE (B) FIG. 8) BEFORE LOOSELY TIGHTENING THE CARRIAGE BOLTS (F).** Further alignment will be necessary after the saw is attached to the stand.

3. Carefully turn the stand right side up.

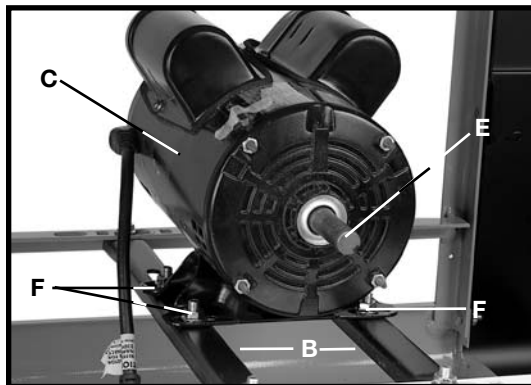

Fig. 6

ATTACHING MOTOR PULLEY

Attach the motor pulley (A) Fig. 7 to the motor shaft, making sure that the set screw (B) in the motor pulley engages with the key (C) in the motor shaft. **NOTE:** The key (D) Fig. 5 is shipped taped to the motor. Remove it, place it on the motor shaft, and attach the pulley over it.

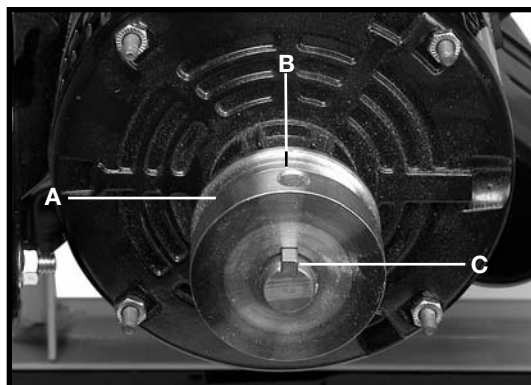

Fig. 7

ATTACHING BAND SAW TO THE STAND

CAUTION: The band saw is very heavy. Use a helper when attaching the saw to the stand.

Attach the band saw to the stand by using the four holes provided (two of which are shown at (A) Fig. 8). Place one 5/16-18 x 1-3/4" hex head screw with a 5/16" flat washer through each hole in the bottom of the band saw and the top of the stand. Thread a 5/16" flange nut on screw and tighten securely.

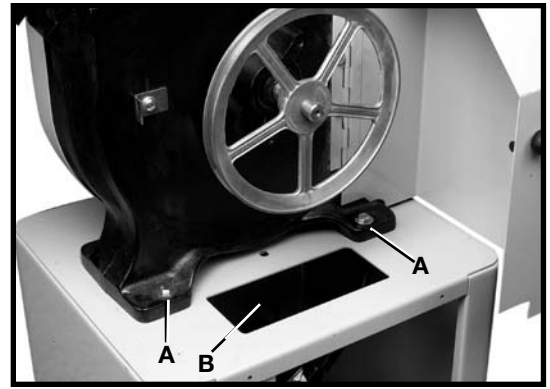

Fig. 8

ATTACHING AND ALIGNING V-BELT, ADJUSTING BELT TENSION

1. Attach the V-belt (E) Fig. 9 on the two pulleys (A and B), and adjust the belt tension by raising or lowering the motor (C) on the motor mounting bars (D). (If necessary, the motor mounting bars (D) can be repositioned on the two posts (F) Fig. 9. Tension is correct when the belt is deflected approximately 1" in the center.
2. Place a straight edge against the belt along the V-groove of both pulleys. Visually check to see that both pulleys are in line. Either pulley can be moved in or out by loosening the set screw (the lower pulley set screw is shown at (B) Fig. 7). After aligning, tighten the set screw. The motor can also be moved on the mounting bars.

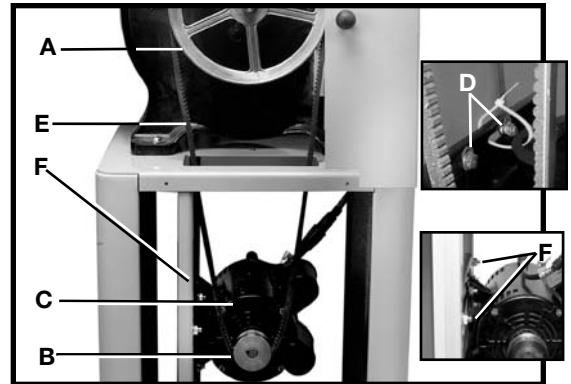

Fig. 9

ATTACHING THE SWITCH

A push-button switch (mounted in a switch box), and a cord set are supplied with the unit. To attach the switch to the band saw arm, do the following:

1. **DISCONNECT TOOL FROM POWER SOURCE.**
2. **CAUTION:** The switch-to-motor cord (F) Fig. 11 must be tied to the horizontal motor support bar (G). This cable tie (H) prevents the switch-to-motor cord (F) from contacting the belt or motor pulley during operation of the unit.

IMPORTANT: Leave this cable tie in place. Remove it **ONLY** when using the Accessory Height Attachment with the machine.

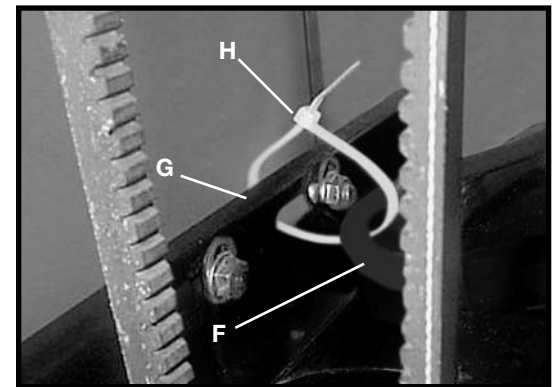

Fig. 11

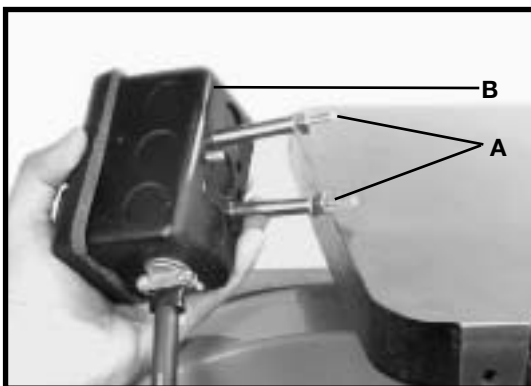

Fig. 12

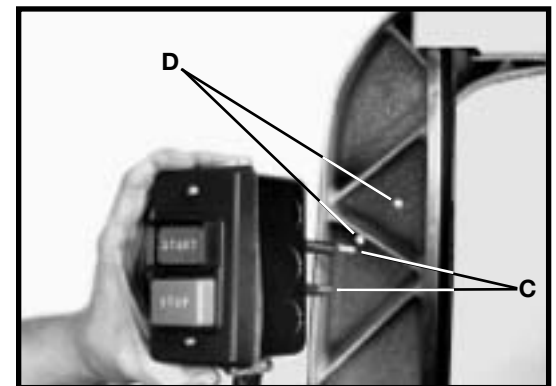

Fig. 13

3. Remove the two outer hex nuts and lock washers (A) Fig. 12 from the two screws extending out from the back of the switch box (B).
4. Insert two screws (C) Figs. 13, located on back of switch box, into two holes (D) located in the band saw arm.

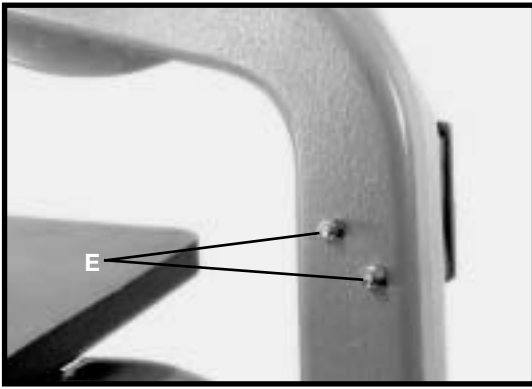

Fig. 14

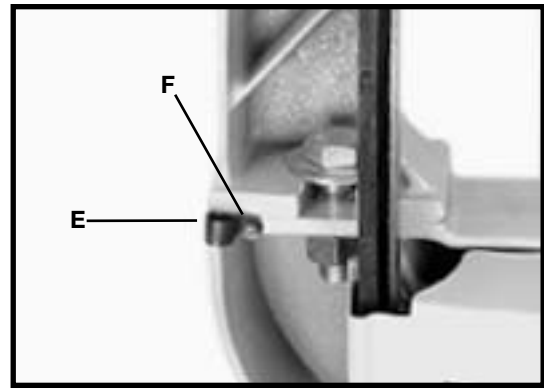

Fig. 15

5. Use the two nuts and lockwashers (E) Fig. 14, removed in STEP 3, to fasten the switch box to the bandsaw arm (Fig. 14).

6. Remove the screw (F) and cable clamp (E) Fig. 15 from the lower arm of the band saw.

7. Insert the switch cord and power cord (F) Fig. 16 into the clamp (E) (removed in **STEP 6**), and fasten to the bandsaw.

8. Push connector end of switch cord through the plastic bushing (G) Fig 16A. and plug it into the motor cord.

IMPORTANT: Be certain to prevent contact between the switch-to-motor cord (F) Fig. 16 and the motor pulley or belt. If necessary, adjust the cord, then tighten the cable tie (H) Fig.11.

9. Attach the two side panels removed earlier.

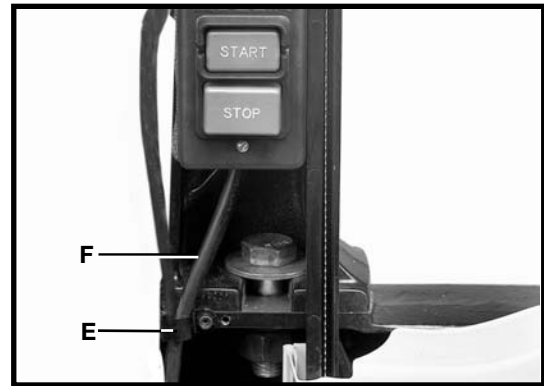

Fig. 16

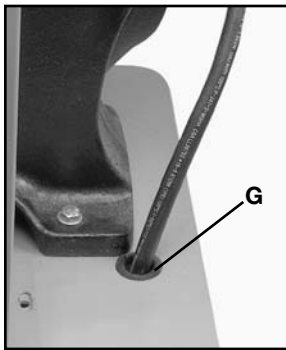

Fig. 16A

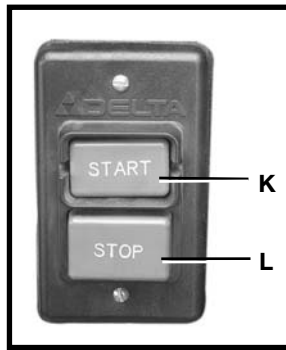

Fig. 17

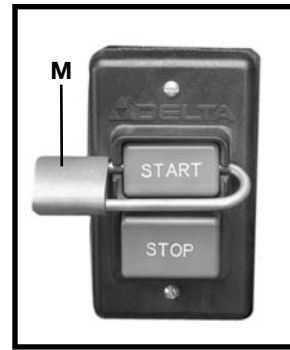

Fig. 18

STARTING AND STOPPING SAW

To start the tool, press the “START” button (K) Fig. 17. To stop the tool, press the “STOP” button (L) Fig. 17.

LOCKING SWITCH IN THE OFF POSITION

IMPORTANT: When the tool is not in use, the switch should be locked in the “OFF” position to prevent unauthorized use, using a padlock (M) Fig. 18 with a 3/16" diameter shackle.

TABLE INSERT

Place the table insert (A) Fig. 19 in the hole provided in the table. Engage the protrusion on the insert in the indent (B) in the table.

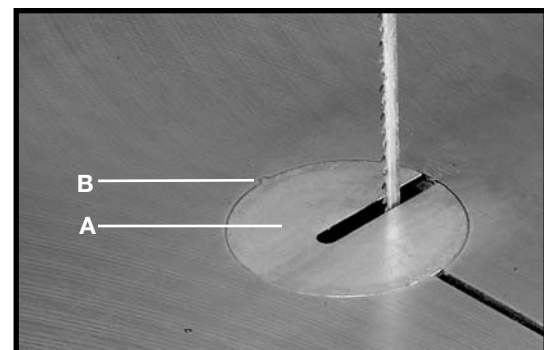

Fig. 19

TILTING THE TABLE

1. The table on the band saw can be tilted 45 degrees to the right and 10 degrees to the left. To tilt the table to the right, loosen the two locking knobs (A) Fig. 20, tilt the table to the desired angle as shown on the scale (D) Figs. 20 and 21, and tighten two locking knobs (A).

2. To tilt the table (C) Fig. 21 to the left, loosen the two locking knobs (A) Fig. 20, and tilt the table to the right until access to the table stop (A) Fig. 21 is gained. Remove the table stop (A) Fig. 21, and tilt the table to the left 10 degrees. Tighten the two locking knobs (A) Fig. 20.

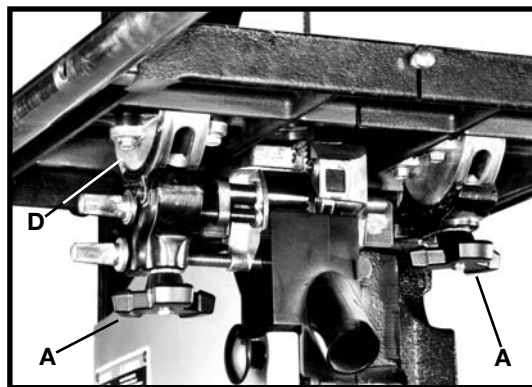

Fig. 20

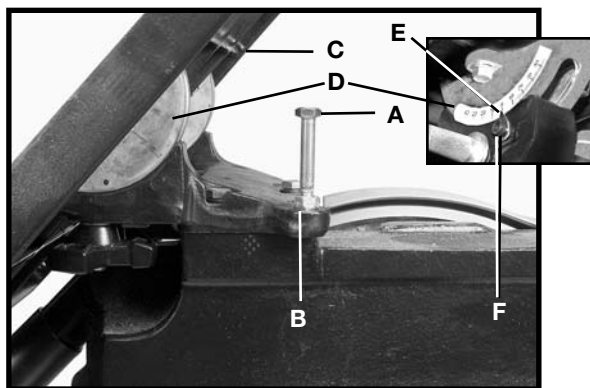

Fig. 21

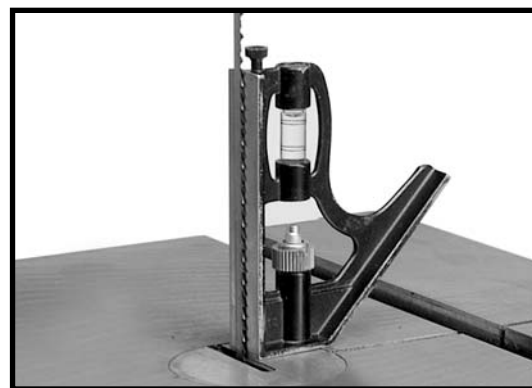

Fig. 22

ADJUSTING THE TABLE STOP

The tool is equipped with an adjustable table stop (A) Fig. 21 that allows the table to be set at 90 degrees to the blade.

Tilt the table (C) Fig. 21 to the right until the table stop (A) Fig. 21 contacts the table. Place a square on the table against the blade (Fig. 22). Check to see if the blade is 90 degrees to the table surface. If not, then do the following:

1. Tilt the table slightly to the left and tighten the table lock knobs.
2. Loosen the locknut (B) Fig. 21 to free the adjusting screw (A) Fig. 21. Turn the adjusting screw (A) right or left to raise or lower the table stop, then tighten the locknut (B).
3. Lower the table. Check to see that the table is 90 degrees to the blade (Fig. 22).
4. When the table is 90 degrees to the blade, check the pointer (E) Fig. 21 to see if it is situated correctly. If not, loosen the screw (F) Fig. 21 and move the pointer to the correct position. Tighten the screw.

ADJUSTING BLADE TENSION

CAUTION: DISCONNECT TOOL FROM POWER SOURCE.

A series of graduations is located on the back of the upper wheel slide bracket. These graduations indicate the proper tension for various widths of blades. With the blade on the wheels, turn the knob (A) Fig. 23 to raise or lower the wheel, until the red fiber washer (B) Fig. 23 is in line with the proper graduation for the size of the blade used.

These graduations are correct for average work, and will not be affected by rebrazing of the saw blade. Use these graduations until you become familiar enough with the operation of the band saw to vary the tension for different kinds of blades or work.

IMPORTANT: OVER-STRAINING IS A COMMON CAUSE OF BLADE BREAKAGE AND OTHER UNSATISFACTORY BLADE PERFORMANCE. RELEASE THE TENSION WHEN THE TOOL IS NOT IN USE.

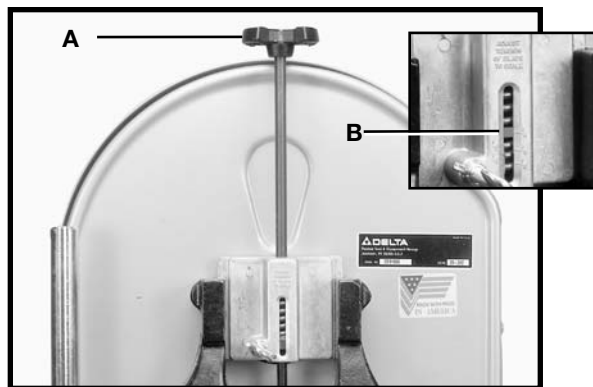

Fig. 23



Fig. 24

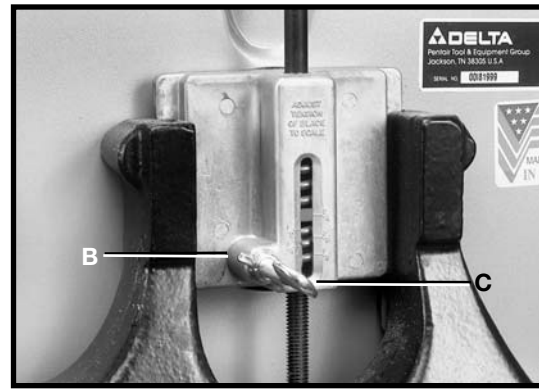

Fig. 25

TRACKING THE BLADE

CAUTION: DISCONNECT TOOL FROM POWER SOURCE.

IMPORTANT: Before tracking the blade, make sure that the blade guides and blade support bearings are clear of the blade.

After applying tension to the blade, rotate the wheels slowly forward by hand and observe the blade's movement. The blade (A) Fig. 24 should travel in the center of the upper tire. If the blade creeps toward the front edge, loosen the wing nut (B) Fig. 25, and tighten the thumb screw (C). This action draws the blade toward the center of the tire. If the blade creeps toward the back edge, turn the thumb screw in the opposite direction. Adjust the thumb screw (C) Fig. 25 only a fraction of a turn each time. **NEVER TRACK THE BLADE WHILE THE TOOL IS RUNNING.** After the blade is tracking in the center of the tires, tighten the wing nut (B) Fig. 25.

VERTICAL ADJUSTMENT OF THE UPPER BLADE GUIDE ASSEMBLY

CAUTION: DISCONNECT TOOL FROM POWER SOURCE.

Adjust the blade guides and bearings according to the following instructions.

Set the upper blade guide assembly (A) Fig. 26 as close as possible to the top surface of the workpiece. Loosen the lock knob (B) and move the guide assembly (A) to the desired position.

If the guide assembly moves when lock knob (B) is loosened, tighten set screw (C) until movement stops.

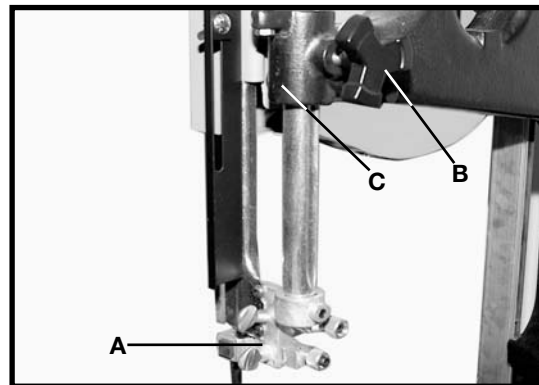

Fig. 26

ADJUSTING THE UPPER BLADE GUIDES AND BLADE SUPPORT BEARING

Adjust the upper blade guides and blade support bearings **ONLY AFTER** the blade has the correct tension and is tracking properly. To adjust, do the following:

1. **DISCONNECT TOOL FROM POWER SOURCE**
2. Make sure that the bottom blade guides and support bearings are clear of the blade.
3. Check the upper blade guide assembly. The blade guides (A) Fig. 27 should be parallel to the blade. To adjust, loosen the screw (B) and rotate the complete guide assembly (C). When the blade guides are parallel with the blade, tighten the screw (B).
4. Adjust the guides (A) Fig. 28 so that the front edge of the guides are just behind the "gullets" of the saw teeth. The complete guide block bracket can be moved in or out by loosening the thumb screw (C) and turning the knurled knob (D) Fig. 28. When the guides (A) are set properly, tighten thumb screw (C).
5. Two set screws (B) Fig. 28 hold the upper blade guides (A) in place. Loosen the set screws (B) to move the guides (A). Place them as close as possible to the side of the blade. (Be careful not to pinch the blade). Tighten the screws (B).
6. The upper blade support bearing (E) Fig. 28 prevents damage to the set in the saw teeth by keeping the blade from being pushed too far toward the back. The support bearing (E) should be set 1/64" behind the blade by loosening the thumb screw (F) and turning the knurled knob (G) to move the support bearing (E) in or out.
7. Adjust the blade support bearing (E) so that the back edge of the blade overlaps the outside diameter of the ball bearing by about 1/16". The bearing (E) is set on an eccentric. To change the position, remove the screw (H) and bearing (E) Fig. 28. Loosen the thumb screw (F), back out the knurled knob from the set screw. Remove the hex shaft from the hole, and rotate it to move the eccentric for the bearing.
8. When the blade guide wears to a point that it cannot be adjusted close to the blade, loosen screw (B) Fig. 28 and reverse the blade guides (A) Fig. 28.

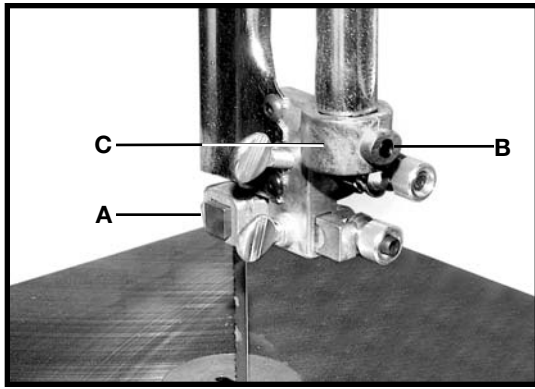

Fig. 27

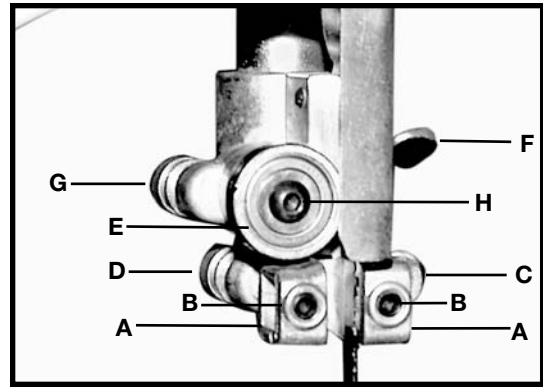

Fig. 29

ADJUSTING LOWER BLADE GUIDES AND BLADE SUPPORT BEARING

Adjust the lower blade guides and blade support bearing after the the upper guides and bearing have been adjusted.

1. DISCONNECT TOOL FROM POWER SOURCE.

2. Adjust the front edge of the guide blocks (B) Fig. 27 so that they are just behind the “gullets” of the saw teeth. Turn the knurled knob (C) Fig. 29 to make this adjustment. Check the support bearing (E) Fig. 28. It should not be touching the back of the blade.

3. Loosen the two screws (A) Fig. 29. Move the guides (B) as close as possible to the side of the blade, being careful not to pinch the blade. Tighten screws (A).

3. Turn the other knurled knob (E) to adjust the lower blade support bearing (D) Fig. 29 so that it is about 1/64" behind the back of the blade.

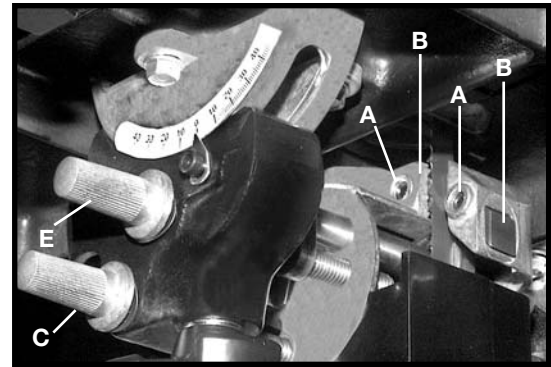

Fig. 29

CHANGING THE BLADES

1. DISCONNECT TOOL FROM POWER SOURCE.

2. Open the upper and lower wheel guards (A) Fig. 30.

3. Release tension on the saw blade (G) Fig 34 by turning knob (B) Fig. 31 counterclockwise.

4. Loosen the table alignment pin (C) Fig. 32 with a wrench and pull out. Remove table insert (D) Fig 32.

5. Take the blade off the wheel (E) Fig. 33, and guide it through the slot in the table (F) Fig. 34.

6. Install the new blade by reversing the procedure. (Table alignment pin should be seated by gently tapping it with a hammer).

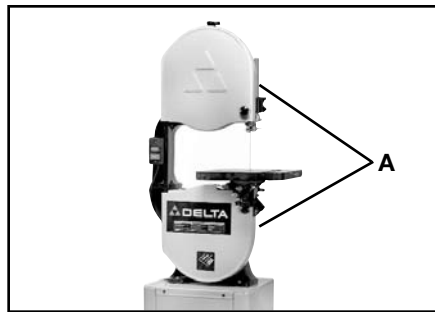

Fig. 30



Fig. 31



Fig. 32

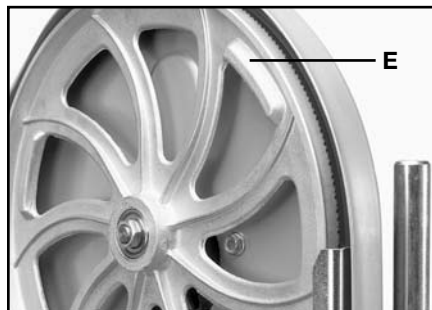

Fig. 33

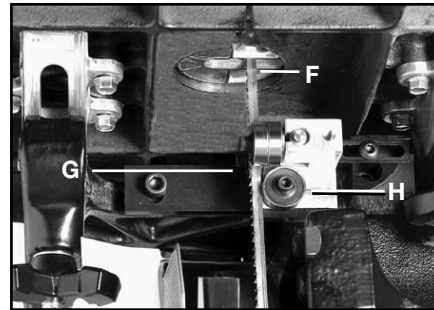

Fig. 34

BAND SAW BLADES

A bandsaw blade is a delicate piece of steel that is subjected to a great deal of stress. Proper blade care results in optimal performance. Always use blades of the proper thickness, width, and temper to correspond to the workpiece.

Use the widest blade possible. Narrow blades should be reserved for small, abrupt curves and delicate work.

When pressure is required to push a workpiece through the blade, either file and set the blade, or replace it. A broken blade can be welded or brazed, but if the blade has been work-hardened, it will soon break again. A good rule of thumb is to sharpen the blade after 4 hours of operation.

Band saw blades will break because of the peculiar stresses to which they are subjected. However, many blades break because the operator (1) does not check the alignment and adjust the guides; (2) forces or twists the blade around a short-radius curve; (3) feeds the workpiece too fast; (4) allows the blade to become dull; (5) tightens the blade tension excessively; (6) sets the top blade guide too high; (7) uses a blade that has been improperly brazed or welded; and/or (8) runs the blade continuously when not cutting.

Blades for the standard 14" Band Saw are 93-1/2" long. The saw can adjust to a maximum length of 94" and a minimum of 91-1/2". If the saw is equipped with the accessory Height Attachment, the blades should be 105" long. Maximum and minimum lengths are 106" and 103-1/2".

OPERATING THE BAND SAW

CAUTION: DISCONNECT TOOL FROM POWER SOURCE.

Before starting the tool, make all adjustments and put all guards in place. Turn the upper wheel clockwise by hand to be sure that everything is correct prior to turning the tool on.

Keep the top guide close to the work. Do not force the material against the blade.

Light contact of the workpiece with the blade will permit easier following of the line and will prevent excess friction, heating, and work-hardening of the blade at its back edge.

Keep the saw blade sharp and very little pressure will be required for average cutting.

Avoid twisting the blade by turning abrupt corners.

CUTTING CURVES

When cutting curves, turn the stock carefully so that the blade may follow without being twisted. If a curve is so abrupt that repeated new kerfs are needed, then use either a narrower blade or one that has more set. The more set a blade has, the easier the stock is to turn. However, the cut is usually rougher than when using a medium set.

When withdrawing the blade, be careful not to draw the blade off of the wheels. In most cases, it is easier and safer to turn the saw and saw out through waste material. Do not back the blade out while the saw is running.

ACCESSORIES

A complete line of accessories is available from your Delta Supplier, Porter-Cable • Delta Factory Service Centers, and Delta Authorized Service Stations. Please visit our Web Site www.deltamachinery.com for a catalog or for the name of your nearest supplier.

 **WARNING:** Since accessories, other than those offered by Delta, have not been tested with this product, use of such accessories could be hazardous. For safest operation, only Delta recommended accessories should be used with this product.



PARTS, SERVICE OR WARRANTY ASSISTANCE

All Delta Machines and accessories are manufactured to high quality standards and are serviced by a network of Porter-Cable • Delta Factory Service Centers and Delta Authorized Service Stations. To obtain additional information regarding your Delta quality product or to obtain parts, service, warranty assistance, or the location of the nearest service outlet, please call 1-800-223-7278 (In Canada call 1-800-463-3582).



Two Year Limited Warranty

Delta will repair or replace, at its expense and at its option, any Delta machine, machine part, or machine accessory which in normal use has proven to be defective in workmanship or material, provided that the customer returns the product prepaid to a Delta factory service center or authorized service station with proof of purchase of the product within two years and provides Delta with reasonable opportunity to verify the alleged defect by inspection. Delta may require that electric motors be returned prepaid to a motor manufacturer's authorized station for inspection and repair or replacement. Delta will not be responsible for any asserted defect which has resulted from normal wear, misuse, abuse or repair or alteration made or specifically authorized by anyone other than an authorized Delta service facility or representative. Under no circumstances will Delta be liable for incidental or consequential damages resulting from defective products. This warranty is Delta's sole warranty and sets forth the customer's exclusive remedy, with respect to defective products; all other warranties, express or implied, whether of merchantability, fitness for purpose, or otherwise, are expressly disclaimed by Delta.

Printed in U.S.A.

NOTES

PORTER-CABLE • DELTA SERVICE CENTERS (CENTROS DE SERVICIO DE PORTER-CABLE • DELTA)

Parts and Repair Service for Porter-Cable • Delta Machinery are Available at These Locations
(Obtenga Refaccion de Partes o Servicio para su Herramienta en los Siguietes Centros de Porter-Cable • Delta)

ARIZONA

Tempe 85282 (Phoenix)
2400 West Southern Avenue
Suite 105
Phone: (602) 437-1200
Fax: (602) 437-2200

CALIFORNIA

Ontario 91761 (Los Angeles)
3949A East Guasti Road
Phone: (909) 390-5555
Fax: (909) 390-5554

San Leandro 94577 (Oakland)
3039 Teagarden Street
Phone: (510) 357-9762
Fax: (510) 357-7939

COLORADO

Arvada 80003 (Denver)
8175 Sheridan Blvd., Unit S
Phone: (303) 487-1809
Fax: (303) 487-1868

FLORIDA

Davie 33314 (Miami)
4343 South State Rd. 7 (441)
Unit #107
Phone: (954) 321-6635
Fax: (954) 321-6638

Tampa 33609
4538 W. Kennedy Boulevard
Phone: (813) 877-9585
Fax: (813) 289-7948

GEORGIA

Forest Park 30297 (Atlanta)
5442 Frontage Road,
Suite 112
Phone: (404) 608-0006
Fax: (404) 608-1123

ILLINOIS

Addison 60101 (Chicago)
400 South Rohlwing Rd.
Phone: (630) 424-8805
Fax: (630) 424-8895

Woodridge 60517 (Chicago)
2033 West 75th Street
Phone: (630) 910-9200
Fax: (630) 910-0360

MARYLAND

Elkridge 21075 (Baltimore)
7397-102 Washington Blvd.
Phone: (410) 799-9394
Fax: (410) 799-9398

MASSACHUSETTS

Braintree 02185 (Boston)
719 Granite Street
Phone: (781) 848-9810
Fax: (781) 848-6759

Franklin 02038 (Boston)
Franklin Industrial Park
101E Constitution Blvd.
Phone: (508) 520-8802
Fax: (508) 528-8089

MICHIGAN

Madison Heights 48071 (Detroit)
30475 Stephenson Highway
Phone: (248) 597-5000
Fax: (248) 597-5004

MINNESOTA

Minneapolis 55429
5522 Lakeland Avenue North
Phone: (763) 561-9080
Fax: (763) 561-0653

MISSOURI

North Kansas City 64116
1141 Swift Avenue
P.O. Box 12393
Phone: (816) 221-2070
Fax: (816) 221-2897

St. Louis 63119
7574 Watson Road
Phone: (314) 968-8950
Fax: (314) 968-2790

NEW YORK

Flushing 11365-1595 (N.Y.C.)
175-25 Horace Harding Expwy.
Phone: (718) 225-2040
Fax: (718) 423-9619

NORTH CAROLINA

Charlotte 28270
9129 Monroe Road, Suite 115
Phone: (704) 841-1176
Fax: (704) 708-4625

OHIO

Columbus 43214
4560 Indianola Avenue
Phone: (614) 263-0929
Fax: (614) 263-1238

Cleveland 44125
8001 Sweet Valley Drive
Unit #19
Phone: (216) 447-9030
Fax: (216) 447-3097

OREGON

Portland 97230
4916 NE 122 nd Ave.
Phone: (503) 252-0107
Fax: (503) 252-2123

PENNSYLVANIA

Willow Grove 19090
520 North York Road
Phone: (215) 658-1430
Fax: (215) 658-1433

TEXAS

Carrollton 75006 (Dallas)
1300 Interstate 35 N, Suite 112
Phone: (972) 446-2996
Fax: (972) 446-8157

Houston 77055
West 10 Business Center
1008 Wirt Road, Suite 120
Phone: (713) 682-0334
Fax: (713) 682-4867

WASHINGTON

Auburn 98001(Seattle)
3320 West Valley HWY, North
Building D, Suite 111
Phone: (253) 333-8353
Fax: (253) 333-9613

Authorized Service Stations are located in many large cities. Telephone **800-438-2486** or **731-541-6042** for assistance locating one. Parts and accessories for Porter-Cable-Delta products should be obtained by contacting any Porter-Cable-Delta Distributor, Authorized Service Center, or Porter-Cable-Delta Factory Service Center. If you do not have access to any of these, call **800-223-7278** and you will be directed to the nearest Porter-Cable-Delta Factory Service Center. Las Estaciones de Servicio Autorizadas están ubicadas en muchas grandes ciudades. Llame al **800-438-2486** ó al **731-541-6042** para obtener asistencia a fin de localizar una. Las piezas y los accesorios para los productos Porter-Cable-Delta deben obtenerse poniéndose en contacto con cualquier distribuidor Porter-Cable-Delta, Centro de Servicio Autorizado o Centro de Servicio de Fábrica Porter-Cable-Delta. Si no tiene acceso a ninguna de estas opciones, llame al **800-223-7278** y le dirigirán al Centro de Servicio de Fábrica Porter-Cable-Delta más cercano.

CANADIAN PORTER-CABLE • DELTA SERVICE CENTERS

ALBERTA

Bay 6, 2520-23rd St. N.E.
Calgary, Alberta
T2E 8L2
Phone: (403) 735-6166
Fax: (403) 735-6144

BRITISH COLUMBIA

8520 Baxter Place
Burnaby, B.C.
V5A 4T8
Phone: (604) 420-0102
Fax: (604) 420-3522

MANITOBA

1699 Dublin Avenue
Winnipeg, Manitoba
R3H 0H2
Phone: (204) 633-9259
Fax: (204) 632-1976

ONTARIO

505 Southgate Drive
Guelph, Ontario
N1H 6M7
Phone: (519) 836-2840
Fax: (519) 767-4131

QUÉBEC

1515 ave.
St-Jean Baptiste,
Québec, Québec
G2E 5E2
Phone: (418) 877-7112
Fax: (418) 877-7123

1447, Begin
St-Laurent, (Montréal),
Québec
H4R 1V8
Phone: (514) 336-8772
Fax: (514) 336-3505

The following are trademarks of PORTER-CABLE-DELTA (Las siguientes son marcas registradas de PORTER-CABLE S.A.): Auto-Set®, BAM-MER®, B.O.S.S.®, Builder's Saw®, Contractor's Saw®, Contractor's Saw II™, Delta®, DELTACRAFT®, DELTAGRAM™, Delta Series 2000™, DURATRONIC™, Emc²™, FLEX®, Flying Chips™, FRAME SAW®, Homecraft®, INNOVATION THAT WORKS®, Jet-Lock®, JETSTREAM®, 'kickstand®, LASERLOC®, MICRO-SET®, Micro-Set®, Midi Lathe™, MORTEN™, NETWORK™, OMNIJIG®, POCKET CUTTER®, PORTA-BAND®, PORTA-PLANE®, PORTER-CABLE®&(design), PORTER-CABLE®PROFESSIONAL POWER TOOLS, Posi-Matic®, Q-3®&(design), QUICKSAND®&(design), QUICKSET™, QUICKSET II®, QUICKSET PLUS™, RIPTIDE™&(design), SAFE GUARD II®, SAFE-LOC®, Sanding Center®, SANDTRAP®&(design), SAW BOSS®, Sawbuck™, Sidekick®, SPEED-BLOC®, SPEEDMATIC®, SPEEDTRONIC®, STAIR EASE®, The American Woodshop®&(design), The Lumber Company®&(design), THE PROFESSIONAL EDGE®, THE PROFESSIONAL SELECT®, THIN-LINE™, TIGER®, TIGER CUB®, TIGER SAW®, TORQBUSTER®, TORQ-BUSTER®, TRU-MATCH™, TWIN-LITE®, UNIGUARD®, Unifence®, UNIFEEDER™, Unihead®, Uniplane™, Unirip®, Unisaw®, Univise®, Versa-Feeder®, VERSA-PLANE®, WHISPER SERIES®, WOODWORKER'S CHOICE™.

Trademarks noted with ™ and ® are registered in the United States Patent and Trademark Office and may also be registered in other countries. Las Marcas Registradas con el signo de ™ y ® son registradas por la Oficina de Registros y Patentes de los Estados Unidos y también pueden estar registradas en otros países.