

HITACHI

INSTRUCTION MANUAL AND SAFETY INSTRUCTIONS FOR CORDLESS ANGLE DRILL

Variable speed

MODEL DN 10DY

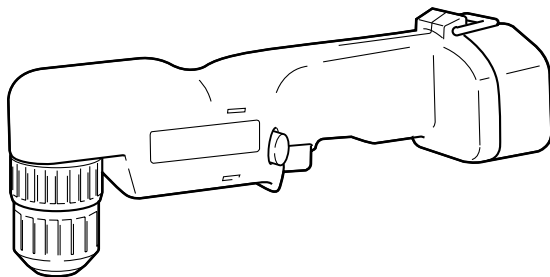

⚠ WARNING:

Improper and unsafe use of this power tool can result in death or serious bodily injury!

This manual contains important information about product safety. Please read and understand this manual before operating the power tool. Please keep this manual available for others before they use the power tool.

— CONTENTS —

	Page
IMPORTANT INFORMATION	3
MEANINGS OF SIGNAL WORDS	3
SAFETY	
IMPORTANT SAFETY INSTRUCTIONS FOR USING ALL POWER TOOLS	4
IMPORTANT SAFETY INSTRUCTIONS FOR USE OF THE CORDLESS HAMMER DRILL	7
IMPORTANT SAFETY INSTRUCTIONS FOR BATTERY CHARGER	7
IMPORTANT SAFETY INSTRUCTIONS FOR USE OF THE BATTERY AND BATTERY CHARGER	8
DISPOSAL OF THE EXHAUSTED BATTERY	9
OPERATION AND MAINTENANCE	
MODEL	10
NAME OF PARTS	10
SPECIFICATIONS	11
ACCESSORIES	12
APPLICATIONS	13
REMOVAL AND INSTALLATION METHOD OF BATTERY	14
CHARGING METHOD	14
BEFORE USE	17
OPERATION	17
MAINTENANCE AND INSPECTION	19
STORAGE	19
SERVICE AND REPAIRS	19
PARTS LIST	20

IMPORTANT INFORMATION

Read and understand all of the operating instructions, safety precautions and warnings in the Instruction Manual before operating or maintaining this power tool.

Most accidents that result from power tool operation and maintenance are caused by the failure to observe basic safety rules or precautions. An accident can often be avoided by recognizing a potentially hazardous situation before it occurs, and by observing appropriate safety procedures.

Basic safety precautions are outlined in the "SAFETY" section of this Instruction Manual and in the sections which contain the operation and maintenance instructions.

Hazards that must be avoided to prevent bodily injury or machine damage are identified by WARNINGS on the power tool and in this Instruction Manual.

Never use this power tool in a manner that has not been specifically recommended by HITACHI, unless you first confirm that the planned use will be safe for you and others.

The warranty of this power tool is separately packed. Before using this power tool, make sure to thoroughly read and understand the content of the warranty.

MEANINGS OF SIGNAL WORDS

WARNING indicates a potentially hazardous situations which, if ignored, could result in serious personal injury.

CAUTION indicates a hazardous situations which, if ignored, could result in moderate personal injury, or could cause machine damage.

NOTE emphasizes essential information.

SAFETY

IMPORTANT SAFETY INSTRUCTIONS FOR USING ALL POWER TOOLS

⚠ WARNING: Death or serious bodily injury could result from improper or unsafe use of power tools. To avoid these risks, follow these basic safety instructions:

READ ALL INSTRUCTIONS

1. NEVER TOUCH MOVING PARTS.

Never place your hands, fingers or other body parts near the tool's moving parts.

2. NEVER OPERATE WITHOUT ALL GUARDS IN PLACE.

Never operate this tool without all guards or safety features in place and in proper working order. If maintenance or servicing requires the removal of a guard or safety feature, be sure to replace the guard or safety feature before resuming operation of the tool.

3. ALWAYS WEAR EYE AND EAR PROTECTION.

Protect yourself from flying or expelled wood chips, metal particles or other debris by using safety goggles or equivalent eye protection. Wear ear protection to protect yourself from excessive noise.

4. AVOID UNINTENTIONAL STARTING.

Don't carry the tool with your finger near the power switch.

5. STORE TOOL PROPERLY.

When not in use, the tool should be stored in a dry place. Keep out of reach of children. Lock-out the storage area.

6. KEEP WORK AREA CLEAN.

Cluttered areas and benches invite injuries.

Clear all work areas and work benches of unnecessary tools, debris, furniture, etc.

7. CONSIDER WORK AREA ENVIRONMENT.

Don't expose power tools to rain.

Don't use power tools in damp or wet locations.

Keep work area well lit and well ventilated.

Don't use tool in presence of flammable liquids or gases.

Power tools produce sparks during operation. They also spark when switching ON/OFF. Never use power tools in sites containing lacquer, paint, benzene, thinner, gasoline, gases, adhesive agents, and other materials which are combustible or explosive.

- 8. KEEP CHILDREN AWAY.**
Do not let visitors contact tool.
All visitors should be kept safely away from work area.
- 9. DON'T FORCE TOOL.**
It will do the job better and safer at the rate for which it was intended.
- 10. USE RIGHT TOOL.**
Don't force small tool or attachment to do the job of a heavy-duty tool.
Don't use tool for purpose not intended-for example-don't use circular saw for cutting tree limbs or logs.
- 11. DRESS PROPERLY.**
Do not wear loose clothing or jewelry.
They can be caught in moving parts. Rubber gloves and non-skid footwear are recommended when working outdoors.
Wear protective hair covering to contain long hair.
- 12. USE FACE OR DUST MAKE IF OPERATION IS DUSTY.**
- 13. SECURE WORK.**
Use clamps or a vise to hold work. It's safer than using your hand and it frees both hands to operate tool.
- 14. DON'T OVERREACH.**
Keep proper footing and balance at all times.
- 15. MAINTAIN TOOLS WITH CARE.**
Keep tools sharp and clean for better and safer performance.
Follow instructions for lubricating and changing accessories.
Keep handles dry, clean, and free from oil and grease.
- 16. REMOVE ADJUSTING KEYS AND WRENCHES.**
Keys and adjusting wrenches remove from tool before turning it on.
- 17. STAY ALERT.**
Watch what you are doing. Use common sense. Do not operate tool when you are tired.
Tools should never be used by you if you are under the influence of alcohol, drugs or medication that makes you drowsy.
- 18. CHECK DAMAGED PARTS.**
Before further use of the tool, a guard or other part that is damaged should be carefully checked to determine that it will operate properly and perform its intended function.
Check for alignment of moving parts, binding of moving parts, breakage of parts, mounting, and any other conditions that may affect its operation. A guard or other part that is damaged should be properly repaired or replaced by an authorized service center unless otherwise indicated elsewhere in this Instruction Manual.
Have defective switches replaced by authorized service center.
Do not use tool if switch does not turn it on and off.
- 19. NEVER USE A POWER TOOL FOR APPLICATIONS OTHER THAN THOSE SPECIFIED.**
Never use a power tool for applications other than those specified in the Instruction Manual.

20. HANDLE TOOL CORRECTLY.

Operate the tool according to the instructions provided herein. Do not drop or throw the tool. Never allow the tool to be operated by children, individuals unfamiliar with its operation or unauthorized personnel.

21. CHECK FOR LIVE WIRES.

Avoid the risk of severe electrical shock by checking for live electrical wires that may be hidden by walls, floors or ceilings. The wires should be de-energized before work begins.

22. KEEP ALL SCREWS, BOLTS AND COVERS TIGHTLY IN PLACE.

Keep all screws, bolts, and plates tightly mounted. Check their condition periodically.

23. DO NOT USE POWER TOOLS IF THE PLASTIC HOUSING OR HANDLE ARE CRACKED.

Cracks in the tool's housing or handle can lead to electric shock.

Such tools should not be used until repaired.

24. BLADES AND ACCESSORIES MUST BE SECURELY MOUNTED TO THE TOOL

Prevent potential injuries to yourself or others. Blades, cutting implements and accessories which have been mounted to the tool should be secure and tight.

25. NEVER USE A TOOL WHICH IS DEFECTIVE OR OPERATING ABNORMALLY.

If the tool appears to be operating unusually, making strange noises, or otherwise appears defective, stop using it immediately and arrange for repairs by an authorized Hitachi service center.

26. CAREFULLY HANDLE POWER TOOLS.

Should a power tool be dropped or struck against hard materials inadvertently it may be deformed, cracked, or damaged.

27. DO NOT WIPE PLASTIC PARTS WITH SOLVENT.

Solvents such as gasoline, thinner, benzine, carbon tetrachloride, and alcohol may damage and crack plastic parts. Do not wipe them with such solvents. Wipe plastic parts with a soft cloth lightly dampened with soapy water.

28. USE ONLY AUTHENTIC HITACHI REPLACEMENT PARTS.

Replacement parts not manufactured by Hitachi may void your warranty and can lead to malfunction and resulting injuries. Authentic Hitachi parts are available from your dealer.

IMPORTANT SAFETY INSTRUCTIONS FOR USE OF THE CORDLESS ANGLE DRILL

⚠ WARNING: Death or serious bodily injury could result from improper or unsafe use of the cordless angle drill. To avoid these risks, follow these basic safety instructions:

1. Never place hands or other body parts near the drill bit or chuck during operation. Hold the drill by its handle only.
2. Because the cordless angle drill operates by battery power, be aware of the fact that it can begin to operate at any time.
3. Wear eye and ear protection at all times.
4. When working at elevated locations, clear the area of all other people and be aware of conditions below you.

IMPORTANT SAFETY INSTRUCTIONS FOR BATTERY CHARGER

1. This manual contains important safety and operating instructions for battery charger Model UC12Y, UC14YF and YC14YF2.
2. Before using battery charger, read all instructions and cautionary markings on (1) battery charger, (2) battery, and (3) product using battery.
3. < UC12Y >
To reduce risk of injury, charge HITACHI rechargeable battery type EB7, EB9, EB12, EB2, B-2, B-3 or B-4. Other type of batteries may burst causing personal injury and damage.
< UC14YF / UC14YF2 >
To reduce risk of injury, charge HITACHI rechargeable battery type EB7, EB9, EB12, EB14 series. Other type of batteries may burst causing personal injury and damage.
4. Do not expose battery charger to rain or snow.
5. Use of an attachment not recommended or sold by the battery charger manufacturer may result in a risk of fire, electric shock, or injury to persons.
6. To reduce risk of damage to electric plug and cord, pull by plug when disconnecting battery charger.
7. Make sure cord is located so that it will not be stepped on, tripped over, or otherwise subjected to damage or stress.
8. An extension cord should not be used unless absolutely necessary. Use of improper extension cord could result in a risk of fire and electric shock.
If extension cord must be used make sure:
 - a. That blades of extension cord are the same number, size, and shape as those of plug on battery charger:
 - b. That extension cord is properly wired and in good electrical condition; and
 - c. That wire size is large enough for AC ampere rating of battery charger as specified in Table 1.

Table 1
RECOMMENDED MINIMUM AWG SIZE FOR
EXTENSION CORDS FOR BATTERY CHARGERS

AC Input Rating Amperes*		AWG Size of Cord			
Equal to or greater than	but less than	Length of Cord, Feet (Meter)			
		25 (7.5)	50 (15)	100 (30)	150 (45)
0	2	18	18	18	16
2	3	18	18	16	14
3	4	18	18	16	14

* If the input rating of a battery charger is given in watts rather than in amperes, the corresponding ampere rating is to be determined by dividing the wattage rating by the voltage rating-for example:

$$\frac{1250\text{watts}}{125\text{ volts}} = 10\text{ amperes}$$

9. Do not operate battery charger with damaged cord or plug-replace them immediately.
10. Do not operate battery charger if it has received a sharp blow, been dropped, or otherwise damaged in any way; take it to a qualified serviceman.
11. Do not disassemble battery charger; take it to a qualified serviceman when service or repair is required. Incorrect reassembly may result in a risk of electric shock or fire.
12. To reduce risk of electric shock, unplug charger from receptacle before attempting any maintenance or cleaning. Removing the battery will not reduce this risk.

IMPORTANT SAFETY INSTRUCTIONS FOR USE OF THE BATTERY AND BATTERY CHARGER

You must charge the battery before you can use the cordless driver drill. Before using the model UC12Y, UC14YF and UC14YF2 battery charger, be sure to read all instructions and cautionary statements on it, the battery and in this manual.

REMEMBER:

< UC12Y >

USE ONLY HITACHI BATTERY TYPE EB7, EB9, EB12, EB2, B-2, B-3 OR B-4.

OTHER TYPES OF BATTERIES MAY BURST AND CAUSE INJURY!

< UC14YF / UC14YF2 >

USE ONLY HITACHI BATTERY TYPES EB7 SERIES, EB9 SERIES, EB12 SERIES, EB14 SERIES.

OTHER TYPES OF BATTERIES MAY BURST AND CAUSE INJURY!

Follow these instructions to avoid the risk of injury:

⚠ WARNING: Improper use of the battery or battery charger can lead to serious injury.
To avoid these injuries:

1. **NEVER** disassemble the battery.
2. **NEVER** incinerate the battery, even if it is damaged or is completely worn out. The battery can explode in a fire.
3. **NEVER** short-circuit the battery.
4. **NEVER** insert any objects into the battery charger's air vents. Electric shock or damage to the battery charger may result.
5. **NEVER** charge outdoors. Keep the battery away from direct sunlight and use only where there is low humidity and good ventilation.
6. < UC12Y >
NEVER charge when the temperature is below 41°F (5°C) or above 104°F (40°C).
< UC14YF / UC14YF2 >
NEVER charge when the temperature is below 32°F (0°C) or above 104°F (40°C).
7. **NEVER** connect two battery chargers together.
8. **NEVER** insert foreign objects into the hole for the battery or the battery charger.
9. **NEVER** use a booster transformer when charging.
10. **NEVER** use an engine generator or DC power to charge.
11. **NEVER** store the battery or battery charger in places where the temperature may reach or exceed 104°F (40°C).
12. **ALWAYS** operate charger on standard household electrical power (120 volts). Using the charger on any other voltage may overheat and damage the charger.
13. **ALWAYS** wait at least 15 minutes between charges to avoid overheating the charger.
14. **ALWAYS** disconnect the power cord from its receptacle when the charger is not in use.

DISPOSAL OF THE EXHAUSTED BATTERY

 **WARNING:** Do not dispose of the exhausted battery. The battery must explode if it is incinerated. The product that you have purchased contains a rechargeable battery. The battery is recyclable. At the end of its useful life, under various state and local laws, it may be illegal to dispose of this battery into the municipal waste stream. Check with your local solid waste officials for details in your area for recycling options or proper disposal.

**SAVE THESE INSTRUCTIONS
AND
MAKE THEM AVAILABLE TO
OTHER USERS OF THIS TOOL!**

OPERATION AND MAINTENANCE

NOTE: The information contained in this Instruction Manual is designed to assist you in the safe operation and maintenance of the power tool.

Some illustrations in this Instruction Manual may show details or attachments that differ from those on your own power tool.

MODEL

DN10DY (1HCK): with battery charger (UC12Y) and case

DN10DY (BFK): with battery charger (UC14YF or UC14YF2) and case

NAME OF PARTS

1. Cordless Angel Drill (DN10DY)

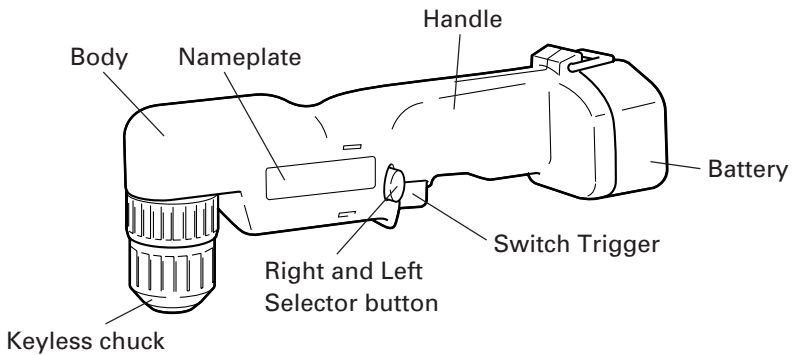

○ Battery (EB9, EB9B)

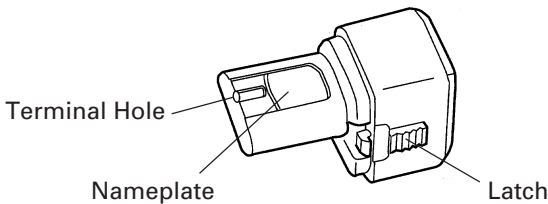
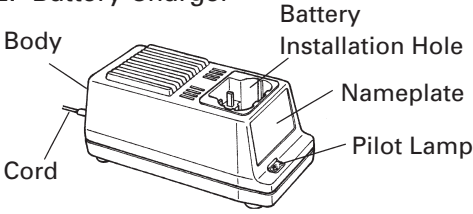
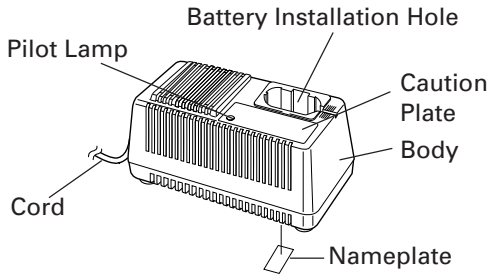

Fig. 1

2. Battery Charger



< UC12Y >



< UC14YF / UC14YF2 >

Fig. 2

SPECIFICATIONS

1. Cordless Angle Drill (DN10DY)

Motor	DC Motor	
No-load speed	0 – 800 rpm	
Capacity	Drilling Wood 9/16" (15 mm) Metal 3/8" (10 mm) Screw Driver Wood screw #11 × 1-3/8" (5.1 mm × 35 mm)	
Drill chuck capacity	Maximum gripping diameter 3/8" (10 mm)	
Battery	EB9 (1.3 Ah)	Nickel cadmium battery Voltage DC9.6 V Charging & discharging frequency UC12Y about 500 times UC14YF / UC14YF2 about 1000 times
	EB9B (2.0 Ah)	
Weight	3.3 lbs (1.5 kg)	

2. Battery Charger



MODEL	UC12Y	UC14YF / UC14YF2
Input power source	Single phase: AC 120V 60 Hz	
Charging time (At a temperature of 68° (F20°C))	EB12 Approx. 60 min.	EB12 Approx. 45 min. EB12B Approx. 60 min.
Charging voltage	DC 2.4 – 12V	DC7.2 – 14.4V
Charging current	DC 1.3A	DC 1.9A
Weight	2.9 lbs. (1.3 kg)	2.9 lbs. (1.3 kg)

ACCESSORIES

⚠ WARNING: Accessories for this power tool are mentioned in this Instruction Manual.

The use of any other attachment or accessory can be dangerous and could cause injury or mechanical damage.

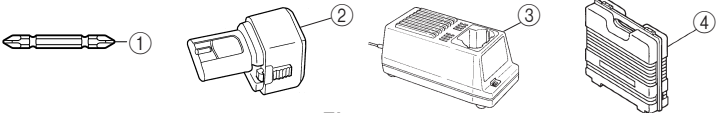
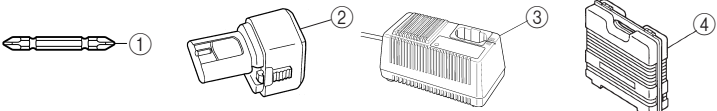
STANDARD ACCESSORIES

<p>DN10DY (1HCK)</p>	 <p style="text-align: center;">Fig. 3-1</p> <ul style="list-style-type: none"> ① Phillips bit (No.2) (Code No. 983006) 1 ② Battery (EB9) (attached to body) 1 ③ Battery Charger (UC12Y) 1 ④ Plastic case (Code No. 308314) 1
<p>DN10DY (BFK)</p>	 <p style="text-align: center;">Fig. 3-2</p> <ul style="list-style-type: none"> ① Phillips bit (No.2) (Code No. 983006) 1 ② Battery (EB9B) (attached to body) 1 ③ Battery Charger (UC14YF or UC14YF2) 1 ④ Plastic case (Code No. 308314) 1
<p>DN10DY (N)</p>	 <p style="text-align: center;">Fig. 3-3</p> <ul style="list-style-type: none"> ① Phillips bit (No.2) (Code No. 983006) 1 ② Battery (EB9) (attached to body) 1

OPTIONAL ACCESSORIES.....sold separately

1. Battery (EB9, EB9B)

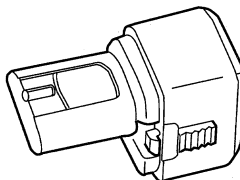

Fig. 4

2. Phillips bit



Fig. 5

Use Driving of wood screws and tapping screws with the head of a plus groove

Size No. 1, No. 2, No. 3

3. Slotted bit

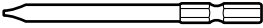

Fig. 6

Use Driving of wood screws with the head of a minus groove

Size 1/8" (3mm), 5/32" (4mm), 1/4" (6.35mm)

4. Iron-working drill bit



Fig. 7

Use Drilling various metals and lumber, making a pilot hole of wood screws

Size 5/64" (2mm), 13/64" (5mm), 15/64" (6mm)

5. Wood-working drill bit



Fig. 8

Use Drilling of various lumber

Size 3/8" (10mm), 1/2" (13mm)

NOTE:

Accessories are subject to change without any obligation on the part of the HITACHI.

APPLICATIONS

- Use as a drill
Drill of mild steel, wood, plastic and aluminum materials.
- Use as a screwdriver
Tightening and loosening of wood screws and tapping screws.

REMOVAL AND INSTALLATION METHOD OF BATTERY

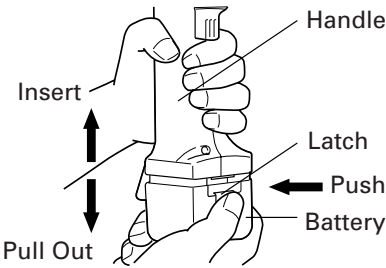
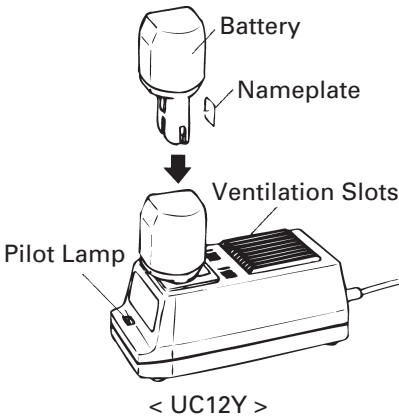

Fig. 9

- How to remove the battery.
Hold the handle tight.
Press the latch located at the front of the battery and pull out the battery. (Fig. 9)
- How to install the battery.
Position the battery so that the latch faces toward the switch trigger in the handle and insert the battery. (Fig. 9)

CHARGING METHOD



< UC12Y >

NOTE:

Before plugging into the receptacle, make sure the following points.

- The power source voltage is stated on the nameplate.
- The cord is not damaged.

⚠ WARNING:

Do not charge at voltage higher than indicated on the nameplate.

If charged at voltage higher than indicated on the nameplate, the charger will burn up.

1. Insert the plug of battery charger into the receptacle.

When the plug of battery charger has been inserted into the receptacle, pilot lamp will blink in red. (At 1-second intervals.)

⚠ WARNING:

Do not use the electrical cord if damaged. Have it repaired immediately.

2. Insert the battery to the battery charger. Insert the battery into the battery charger as shown in Fig. 10.

Make sure it contacts the bottom of the battery charger.

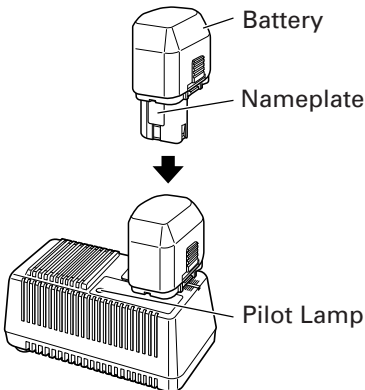

< UC14YF / UC14YF2 >

Fig. 10

3. Charging

- When the battery is connected to the battery charger, charging will commence and the pilot lamp will light in red. (See Table 2)





NOTE: If the pilot lamp does not light, pull out the plug from the receptacle and check if the battery is properly mounted.

- When the battery is fully charged, the pilot lamp will blink in red slowly. (At 1-second intervals) (See Table 2)

(1) Pilot lamp indication

The indications of the pilot lamp will be as shown in Table 2, according to the condition of the charger or the rechargeable battery.

Table 2

Indications of the pilot lamp			
Before charging	Blinks (RED)	Lights for 0.5 seconds. Does not light for 0.5 seconds. (off for 0.5 seconds) 	/
While charging	Lights (RED)	Lights continuously 	
Charging completed	Blinks (RED)	Lights for 0.5 seconds. Does not light for 0.5 seconds. (off for 0.5 seconds) 	
Charging impossible	Flickers (RED)	Lights for 0.1 seconds. Does not light for 0.1 seconds. (off for 0.1 seconds) 	Malfunction in the battery or the charger
Charging impossible (UC14YF / UC14YF2 only)	Lights (GREEN)	Lights continuously 	The battery temperature is high, making recharging impossible.

(2) Regarding the temperature of the rechargeable battery.

The temperatures for rechargeable batteries are as shown in the table below, and batteries that have become hot should be cooled for a while before being recharged.

Table 3 Recharging of batteries that have become hot

Rechargeable batteries	Temperatures at which the battery can be recharged
EB 9	23°F—104°F (–5°C—40°C)
EB 9B	23°F—140°F (–5°C—60°C)

(3) Regarding recharging time (At 68°F (20°C))

Depending on the combination of the charger and batteries, the charging time will become as shown in Table 4.

Table 4

Battery \ Charger	UC12Y	UC14YF / UC14F2
EB 9	Approx. 60 min.	Approx. 45 min.
EB 9B		Approx. 60 min.

NOTE: The charging time may vary according to temperature and power source voltage.

4. Disconnect battery charger from the receptacle.

⚠ CAUTION: Do not pull the plug out of the receptacle by pulling on the cord.
Make sure to grasp the plug when removing from receptacle to avoid damaging cord.

5. Remove the battery from the battery charger.
Supporting the battery charger with hand, pull out the battery from the battery charger.

⚠ CAUTION:

- When the battery charger has been continuously used, the battery charger will heated, thus constituting the cause of the failures. Once the charging has been completed, give 15 minutes rest until the next charging.
- If the battery is recharged when it is warm due to battery use or exposure to sunlight, the pilot lamp may light in green.
The battery will not be recharged. In such a case, let the battery cool before charging.
- When the pilot lamp flickers rapidly in red (at 0.2–second intervals), check for and take out any foreign objects in the charger’s battery installation hole. If there are no foreign objects, it is probable that the battery or charger is malfunctioning. Take it to your authorized Service Center.

Regarding electric discharge in case of new batteries, etc.

As the internal chemical substance of new batteries and batteries that have not been used for an extended period is not activated, the electric discharge might be low when using them the first and second time. This is a temporary phenomenon, and normal time required for recharging will be restored by recharging the batteries 2 – 3 times.

How to make the batteries perform longer.

- (1) Recharge the batteries before they become completely exhausted.

When you feel that the power of the tool becomes weaker, stop using the tool and recharge its battery. If you continue to use the tool and exhaust the electric current, the battery may be damaged and its life will become shorter.

- (2) Avoid recharging at high temperatures.

A rechargeable battery will be hot immediately after use. If such a battery is recharged immediately after use, its internal chemical substance will deteriorate, and the battery life will be shortened. Leave the battery and recharge it after it has cooled for a while.

BEFORE USE

Check the work area to make sure that it is clear of debris and clutter.

Clear the area of unnecessary personnel. Ensure that lighting and ventilation is adequate.

OPERATION

1. Mounting and dismounting the bit

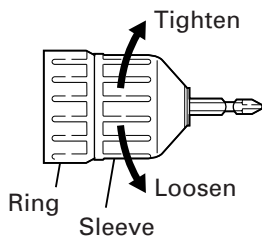

Fig. 11

- (1) Mounting the bit

Insert a screwdriver bit etc. into the keyless drill chuck.

Firmly grasp the ring and tighten the sleeve by turning it toward the right (in the clockwise direction as viewed from the front). (See Fig. 11)

NOTE:

If the sleeve becomes loose during operation, tighten it further. The tightening force becomes stronger when the sleeve is tightened.

- (2) Dismounting the bit.

Firmly grasp the ring and loosen the sleeve by turning it toward the left (in the counterclockwise direction as viewed from the front). (See Fig. 11)

⚠ CAUTION: When mounting a bit into the keyless chuck, tighten firmly.
If the sleeve is not tight, the bit may slip or fall out, causing injury.

2. Check the attachment of the battery.

⚠ CAUTION: Install the battery properly.
If not installed properly, it may fall out of the power tool and cause danger.

3. Check the direction of rotation.

The bit rotates clockwise (viewed from the rear side) by pushing the R-side of the selector button. The L-side of the selector button is pushed to turn the bit counterclockwise. (See Fig. 12) (The (R) and (L) marks are provided on the body.)

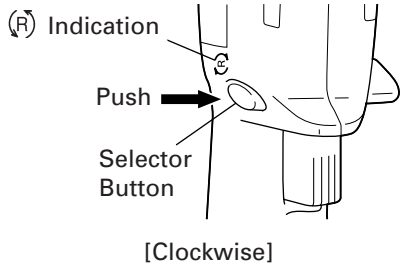

4. Switch operation

- When the switch trigger is pulled, the bit rotates.
- When trigger is let loose, the bit stops.
- The rotational speed can be controlled by varying the amount that the switch trigger is pulled. Speed is low when the switch trigger is pulled slightly and increases as the switch is pulled more.

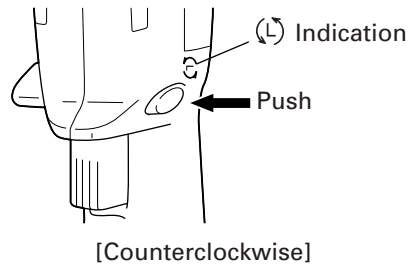

NOTE

A buzzing noise is produced when the motor is about to rotate; this is only a noise, not a machine failure.

5. To use for drilling metal

- In case you drill metal with an iron-working drill bit, apply in advance a center punch in the drilling position. You can drill metal stably since the point of the drill bit does not slip.
- If you apply sewing machine oil or soapy water to the drill bit with a brush or an old tooth brush, the drill bit will last long.
- When drilling a hole, it cannot be drilled more rapidly by applying more than the required force. On the contrary, the edge of the drill bit will be damaged. This will decrease operational efficiency and shorten the life of this POWER TOOL.

CAUTION:

- The motor rotation may be locked to cease while the Cordless angle drill is used as a drill. The motor must be burnt or the battery life must remarkably be reduced when the locked condition is continued for several seconds.
- Drilling a hole in the metal exerts considerable force on the edge of the hole so that the drill bit may slip from the keyless chuck. If this happens, decrease the pushing pressure on the Cordless angle drill so that the drill bit does not slip.
- While operating the Cordless angle drill, take care not to lock the motor. If the motor is locked, immediately turn the power off.
- Do not tighten too strongly as the screw heads will be damaged.
- When pressing the tool against the object to be drilled, take care not to touch the keyless chuck with your hands.

MAINTENANCE AND INSPECTION

⚠ CAUTION: Pull out battery before doing any inspection or maintenance.

1. Checking the condition of the bit.

The bits should be checked regularly. If worn or broken bits can slip or decrease the efficiency of the motor and burn it out.

Replace worn bits with new ones.

⚠ CAUTION: If you use a driver bit of which point is worn or broken, it will be dangerous since it slips. So replace it with a new one.

2. Check the Mounting Screws

Loose mounting screws are dangerous. Regularly inspect them and make sure they are tight.

⚠ CAUTION: Using this power tool with loosen, screws is extremely dangerous.

3. Check for Dust

Dust may be removed with a soft cloth or a cloth dampened with soapy water.

Do not use bleach, chlorine, gasoline or thinner, for they may damage the plastics.

STORAGE

Storing in a place below 104°F (40°C) and out of the reach of children.

SERVICE AND REPAIRS

All quality power tools will eventually require servicing or replacement of parts because of wear from normal use. To assure that only authorized replacement parts will be used, all service and repairs must be performed by a HITACHI AUTHORIZED SERVICE CENTER, ONLY.

NOTE:

Specifications are subject to change without any obligation on the part of the HITACHI.

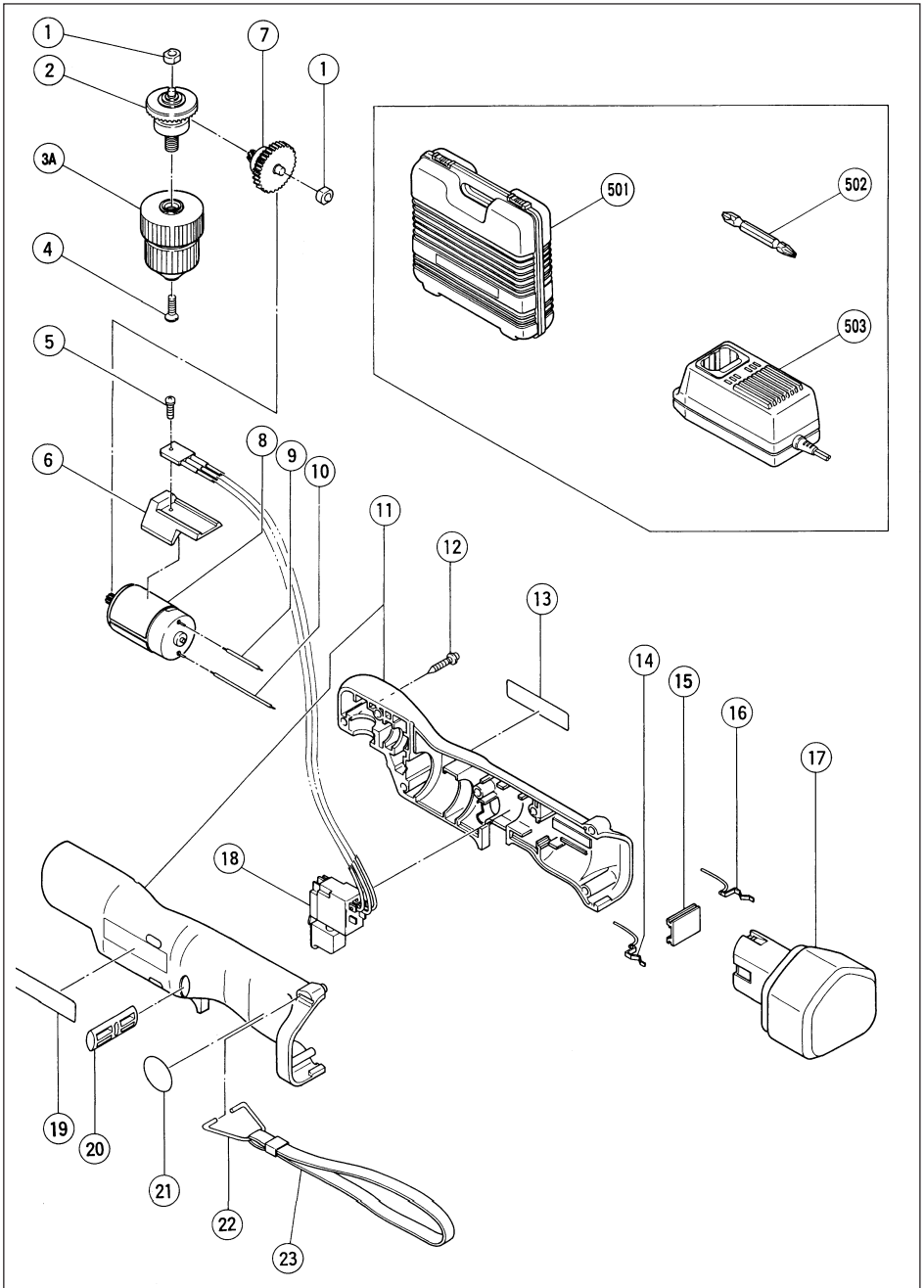

Item No.	Part Name
1	Metal
2	Spindle
3A	Drill Chuck 10TLRD-N
4	Flat Hd. Screw (Left Hand) M5×17
5	Bind Screw M3×7
6	Fin
7	Second Pinion
8	Motor
9	Internal Wire (A)
10	Internal Wire (A)
11	Housing (A)•(B) Set
12	Tapping Screw (W/Washer) M3×16
13	Name Plate
14	Terminal (B)
15	Terminal Support
16	Terminal (B)
17	Battery EB9
18	DC-Speed Control Switch
19	HITACHI Label
20	Pushing Button
21	Mark Plate
22	Hook
23	Strap
501	Case
502	Phillips Bit No.2 65L
503	Charger (Model UC12Y)

Parts are subject to possible modification without notice due to improvements.

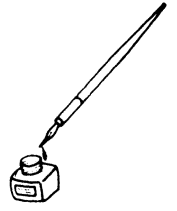

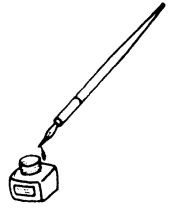

WARNING:

Some dust created by power sanding, sawing, grinding, drilling, and other construction activities contains chemicals known to the State of California to cause cancer, birth defects or other reproductive harm. Some examples of these chemicals are:

- Lead from lead-based paints,
- Crystalline silica from bricks and cement and other masonry products, and
- Arsenic and chromium from chemically-treated lumber.

Your risk from these exposures varies, depending on how often you do this type of work. To reduce your exposure to these chemicals: work in a well ventilated area, and work with approved safety equipment, such as those dust masks that are specially designed to filter out microscopic particles.



Please contact HITACHI KOKI U.S.A. LTD. at 1-800-59-TOOLS (toll free), or HITACHI AUTHORIZED POWER TOOL SERVICE CENTER regarding COLLECTION.

Issued by

Hitachi Koki Co., Ltd.

Shinagawa Intercity Tower A, 15-1, Konan 2-chome,
Minato-ku, Tokyo 108-6020, Japan

Distributed by

Hitachi Koki U.S.A., Ltd.

3950 Steve Reynolds Blvd.
Norcross, GA 30093

Hitachi Koki Canada Co.

6395 Kestrel Road
Mississauga ON L5T 1Z5

205

Code No. C99058363
Printed in Ireland