

HOTPOINT SERVICE

SERVICE CALL: If you have a problem with your appliance ring your local Service Office. **SPARES and ACCESSORIES:** To purchase spares and accessories send your Accessories Order Form to your Service Centre. If the accessory or spare part you want is not on the form then contact your Service Centre for prices and availability. Please address all correspondence to Hotpoint Service Centre or Hotpoint Service Office as applicable.

IRELAND

Northern Ireland:
256 Ormeau Road, Belfast,
BT7 2FZ.
Tel: Belfast 647111.
Eire: 35/36 Arran Quay,
Dublin 7.
Tel: Dublin 725922.
Spares and accessories
may be ordered from
either address.

NORTH WEST

- **KENDAL:** 2B Highgate, LA9 4SX.
Tel: Kendal 24483.
- **PRESTON:** 24/25 Cannon Street,
PR1 3NR. Tel: Preston 24311.
- **ST. HELENS:** 40 Cowley Hill Lane,
FULESBURGH, ST. HELENS S18 1SQ.
- **LIVERPOOL:** 1 Church Parade, L66 2ER.
Tel: 051-358 2141.
- **STOCKPORT:** 44/46 Station Road,
Heaton Mersey, SK4 3OT.
Tel: Office 061-442 8677
Centre 061-432 0255.

WALES

- **LLANIDNO JUNCTION:** Conwy Road,
LL31 1RZ. Tel: Dinorwig 82926.
- **BRIDGEND:** 18 Western Avenue,
Bridgend Industrial Estate, CF31 3SL.
Tel: Office Bridgend 64121
Centre Bridgend 64127.

WEST MIDLANDS

- **STOKE-ON-TRENT:** West Avenue,
Wilson Estate, Talke S17 1TN.
Tel: Office 090 74611. WSS 91UX
- **ALDRIDGE:** 114/116 WSS 91UX
Tel: Office Aldridge 55441/55561
Centre Aldridge 55566.

SOUTH MIDLANDS

- **DIDCOT:** 22/48 Broadway, OX11 8RS.
Tel: Didcot 0171711.
Spares and accessories may be ordered
from either Aldridge or Wembley
Centres.

SOUTH WEST

- **BRISTOL:** 3/5 Wellington Hill, Brislington, BS1 5BG. Tel: Bristol 714471.
- **PLYMOUTH:** 36 Wellington Plain, Plymouth PL1 2JH. Tel: Plymouth 2626/34 35A.
- **TOTTON:** South Hampshire Industrial Park, Salisbury Road, SO4 3SA.
Tel: Office Totton 861981
Centre Totton 867833.

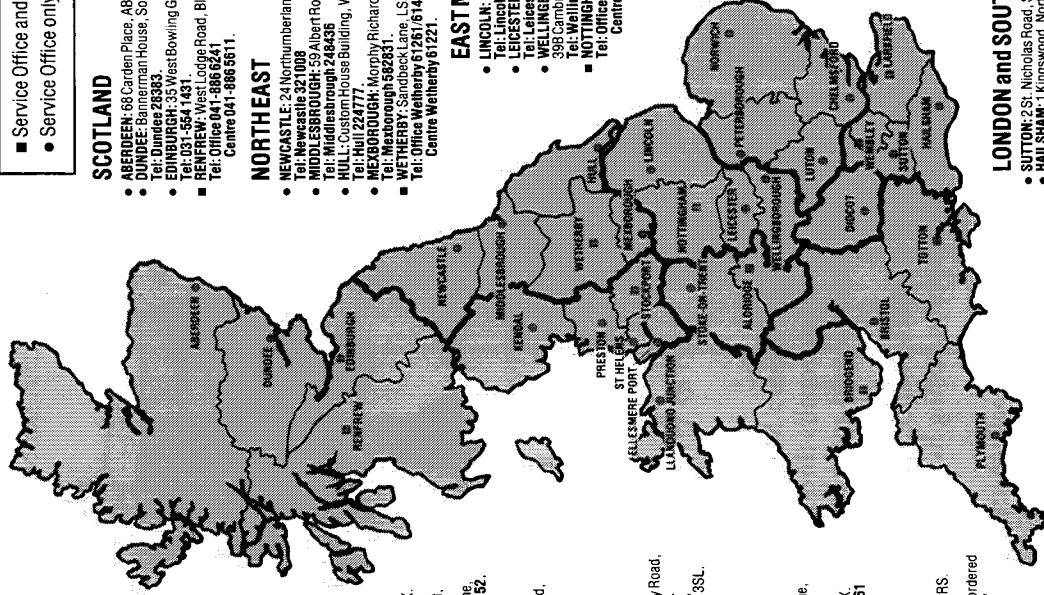

SCOTLAND

- **ABERDEEN:** 68 Carden Place, AB11 1UL. Tel: Aberdeen 642283.
- **DUNDEE:** Bannerman House, South Tay Street, DD1 1NR.
Tel: Dundee 28383.
- **EDINBURGH:** 35 West Bowling Green Street, Leith, EH6 5N.
Tel: 031-554 1431.
- **RENFREW:** West Lodge Road, Blythswood Estate, PA4 9EN.
Tel: Office 041-886 6241
Centre 041-886 5511.

NORTHEAST

- **NEWCASTLE:** 24 Northumberland Road, NE1 8AJ.
Tel: Newcastle 321008
- **MIDDLESBROUGH:** 59 Albert Road, TS1 1NG.
Tel: Middlesbrough 248436
- **HULL:** Custom House Building, Whitefriargate, HU1 2EU.
Tel: Hull 224777.
- **MEXBOROUGH:** Morphy Richards, Swinton Works, S64 8AJ.
Tel: Mexborough 662821.
- **WETHERBY:** Sandbeck Gate, LS22 4TW.
Tel: Office Wetherby 011761444
Centre Wetherby 01221.

EAST MIDLANDS

- **LINCOLN:** Firth Road, LN6 7BW.
Tel: Lincoln 23611
- **LEICESTER:** 85 Belgrave Gate, LE1 3HR.
- **WELLS:** 100 St. Giles Street,
NG2 1JF. Tel: Nottingham 620581.
- **WELLINGTON:** 39B Cambridge Street, NR8 1DW.
Tel: Wellington 223669
- **NOTTINGHAM:** Ashling Street, NG2 3JB.
Tel: Office Nottingham 62431
Centre Nottingham 660387.

EASTERN

- **NORWICH:** 100 St. Giles Street,
NG2 1JF. Tel: Norwich 620581.
- **PETERBOROUGH:** Cella Road, PE2 9JB.
Tel: Peterborough 647
- **LUTON:** 5 Crawley Road,
LU1 1HX.
Tel: Luton 452211.
- **CHELMSFORD:** Industrial Buildings,
Beane Lane, CM2 9TE.
Tel: Chelmsford 265331.
Spares and accessories
may be ordered from
Hotpoint Spares
Administration Dept.,
Centre Peterborough,
PE2 9JB. Tel:
Peterborough 68989.

LONDON and SOUTHEAST

- **SUTTON:** 2/S, Nicholas Road, SM1 1EH. Tel: 01-643 0921
- **HAILSHAM:** 1 Kingswood, North Street, BN27 1DD.
Tel: Hailsham 842733
- **WEMBLEY:** 66 Ess Lane, HA9 7PQ.
Tel: Service Office for S. Herts and Middlesex 01-908 1933
Service Centre 01-904 0201
- **LARKFIELD:** Larkfield Trading Estate, New Hythe Lane,
ME20 6SW. Tel: Office Maidstone 76571
Centre Maidstone 76531.

ELECTRONIC 800 PLUS

USER HANDBOOK - MODEL 9510

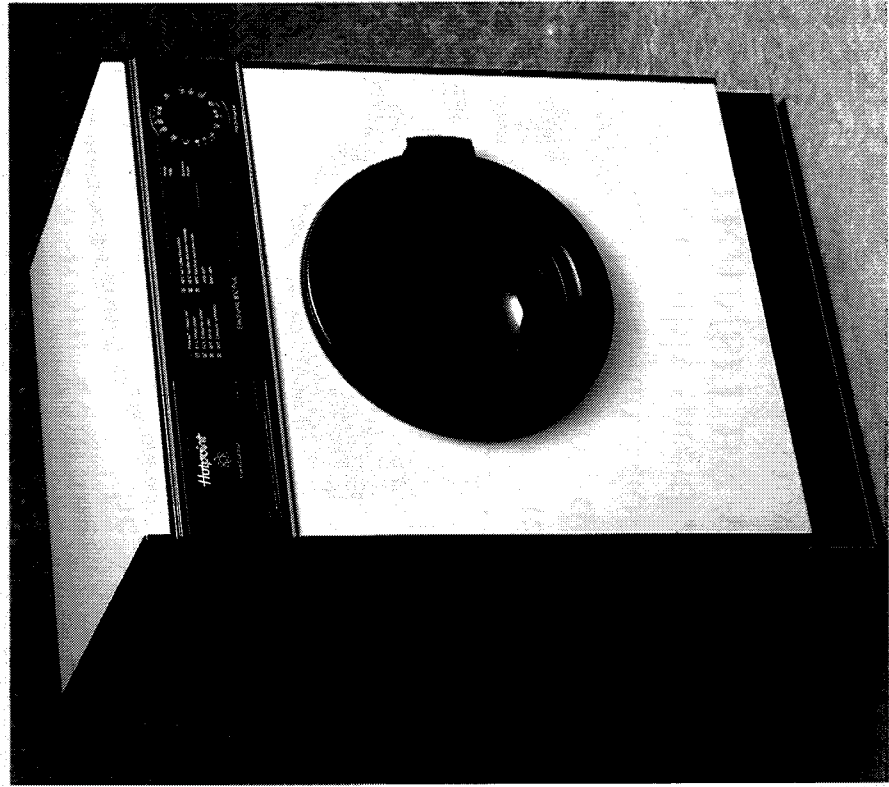

Hotpoint®

In accordance with its policy of progressive product design, the company reserves the right to alter specifications.

Your new Automatic

Using your new Hotpoint Automatic is easy. You just put in your laundry, add washing powder, set the controls to the programme you require and switch on. Your machine will now go through its wash cycle in the way you have chosen.

It couldn't be simpler! Nevertheless before you use your machine, read through this handbook so that you get the best out of your new machine right from the start.

You should have already followed the instructions in the **INSTALLATION INSTRUCTIONS** booklet and your machine will be ready to work. If not, **do not proceed any further** until you have done so.

Please make doubly sure that you have removed the **TRANSIT BRACKET**. The procedure for doing this is shown on the label on the back of the machine.

YOU MUST NOT OPERATE THE MACHINE WITH THE TRANSIT BRACKET IN PLACE.

Hotpoint Service Cover

Five year guarantee.

From the moment your appliance is delivered, Hotpoint guarantees it for FIVE YEARS.

During the five years all parts are completely free of charge provided they are fitted by Hotpoint's own Service Engineer. Labour costs are chargeable after the first year.

This guarantee does not cover accidents or negligence. The appliance must be used in the United Kingdom and must not be tampered with or taken apart by anyone who is not an authorised Hotpoint representative. Hotpoint's guarantee in no way limits your legal rights.

Service is provided by Hotpoint's own service organisation. Should you have any problems, simply telephone your nearest Service Office (see back page).

Installation check.

On request to your local Service Office (see back page) Hotpoint will send one of its trained Engineers to make sure that the machine has been properly unpacked and correctly connected to existing water and electrical supplies.

If necessary, the Engineer will also be happy to explain to you how your new appliance works.

Hotpoint Maintenance Plan.

At the end of the first year, Hotpoint offers a Maintenance Plan which, for an annual payment, provides free of charge repairs throughout the membership period and also includes a free maintenance visit at the end of each year of cover.

Hotpoint recommends an annual maintenance visit so that a mechanical and electrical safety check can be carried out including lubrication and replacement of parts where necessary.

To ensure that you have an opportunity of participating in the Plan, please complete and post the Registration Card to your nearest Service Office (see back page). Full details of the Plan, together with an application form, will be sent to you in 12 months time.

Membership is renewable each year by mutual agreement.

Proof of purchase.

For future reference please attach your purchase receipt to this booklet and keep it in a safe place.

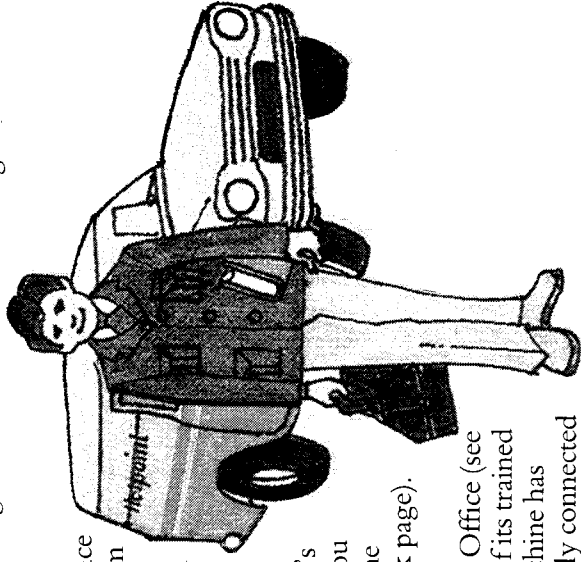

What next?

If you have been through the checklist and your machine is still not working properly switch off and unplug the machine at the socket, turn off the hot and cold water taps, and call your nearest Service Office or local importer (outside the UK). The telephone number is shown on the back page. Please note the number down in this space for future reference:

When you contact us we will want to know:

1. Your name, address and post code.
2. Your telephone number.
3. Clear and concise details of the fault.
4. The Model number 9510 and colour.
5. The date of Purchase (enter here now):
6. If you have taken out a Hotpoint Maintenance Plan.

Make sure you have all these details before you call.

Emergency opening of the door.

If the machine is full of water with your clothes inside, you can open the door by following these instructions:

You will have to reduce the water level so that the door safety lock is released. You will need to remove about two bucketfuls. Do this by unscrewing the drain hose retaining clip (see page 5) and place the end of the hose in a bucket on the floor.

WARNING – BE CAREFUL, THE WATER MAY BE VERY HOT.

When sufficient has been removed, return the drain hose to its original position. Allow one minute and then press the door release button to open.

Finally, turn the water supply to the machine off, switch off the electricity and unplug the machine. Do not use it again until the Service Engineer has called.

Contents

The main parts of your Automatic	4-5
Getting the laundry ready	6-7
Sorting	
Mixed Fabric Loads	
Pre-Treatment	
ITCL Codes Explained	
How to load the laundry	8
Special care for woollens	9
Getting the machine ready	10-11
Opening the Door	
Putting in the Washing Powder	
Using Fabric Conditioner	
Wash Programme Guide and Checklist	12-13
The controls	14-16
Switching On and Off	
Selecting a Programme	
Selecting a Pre-Wash	
Selecting Optional Wash Features	
Economy Wash, Rinse Hold	
Quick Wash	
Rinsing and Spinning	
The machine at work	17
Content of programmes	
Length of programmes	
Caring for your machine	18
What to do if your machine goes wrong	19-24
Checklist	
What next – Contacting the Service Office	
How to Open the Door in an emergency	
Hotpoint Service Cover	
Hotpoint Service Offices	



Get to know the main parts

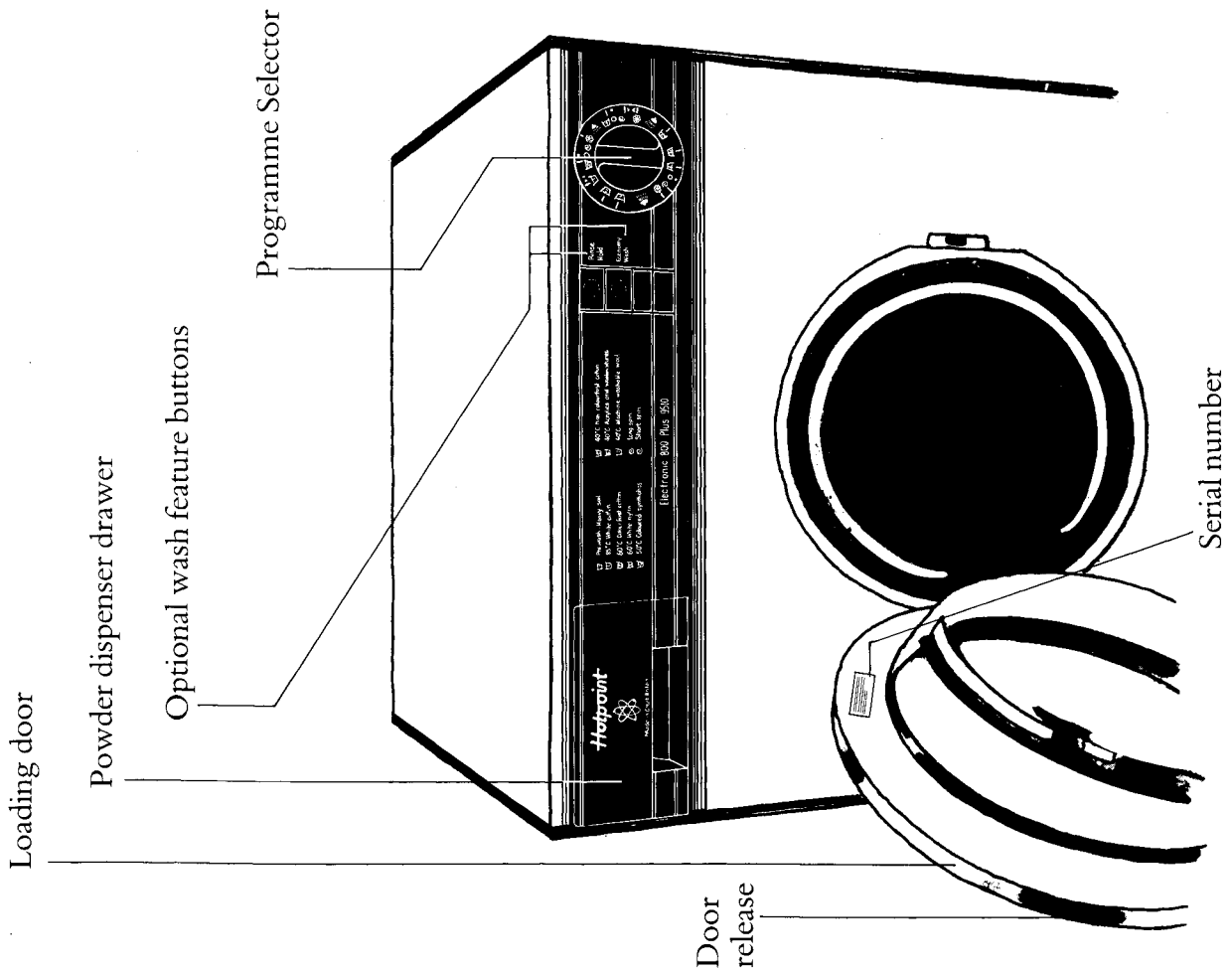

The door won't open.

Make sure that:
 The Programme Selector is pushed in (page 14).
 There is no water in the drum.
 You have waited two minutes for the Safety Latch to open.
 It is not on Rinse Hold (page 14).

The clothes come out dirty.

Make sure that you used the right amount of powder (pages 10/11).
 Were the clothes heavily soiled? Try using Pre-Wash for maximum cleaning (page 14).
 Did you use Economy Wash for heavily soiled laundry?
 Make sure that you did not over-load the machine (page 8).

The machine is leaking.

Make sure that the hot and cold water hoses are firmly attached.
 If your machine is not permanently plumbed in, did you empty the hoses into a bucket after disconnecting them from the taps?

The clothes come out too wet.

You may have selected the wrong programme for the type of fabric.



What to do if your machine goes wrong (cont'd)

- It fills, but the water empties from the drain hose.** Make sure that the drain hose is at least 500 mm (20in) above floor level. (See Installation Instructions booklet.)
- It has filled and tumbled but stopped.** It is probably heating up; if you wait a few minutes it will continue.
- Suds are coming out.** Make sure that:
 You used a low suds powder.
 You did not use too much powder. (See pages 10/11.)
 To clear – switch off, turn the Programme Selector to the  symbol at the end of the washes and switch on. The machine will empty and then rinse.
- It keeps stopping and ticking.** Don't worry, the timer is working and selecting the next operation.
- It has stopped full of water and won't go on.** Check if it is on Rinse Hold (page 15). If it is, press and release the Rinse Hold button and the machine will continue.
 Check that the drain hose is not kinked.
- It makes a noise when spinning.** Unfortunately, all fast spinning automatics make some noise. You can minimise the noise by making certain that your machine is correctly installed and not touching anything. (See Installation Instructions booklet.)

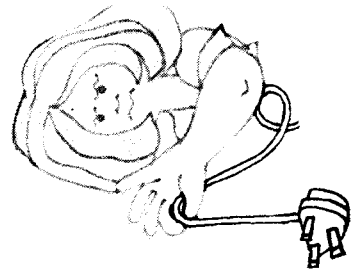

of your Automatic

Rating plate

Drain hose

Mains cable

Cold water inlet point and hose (blue)

Hot water inlet point and hose (red)

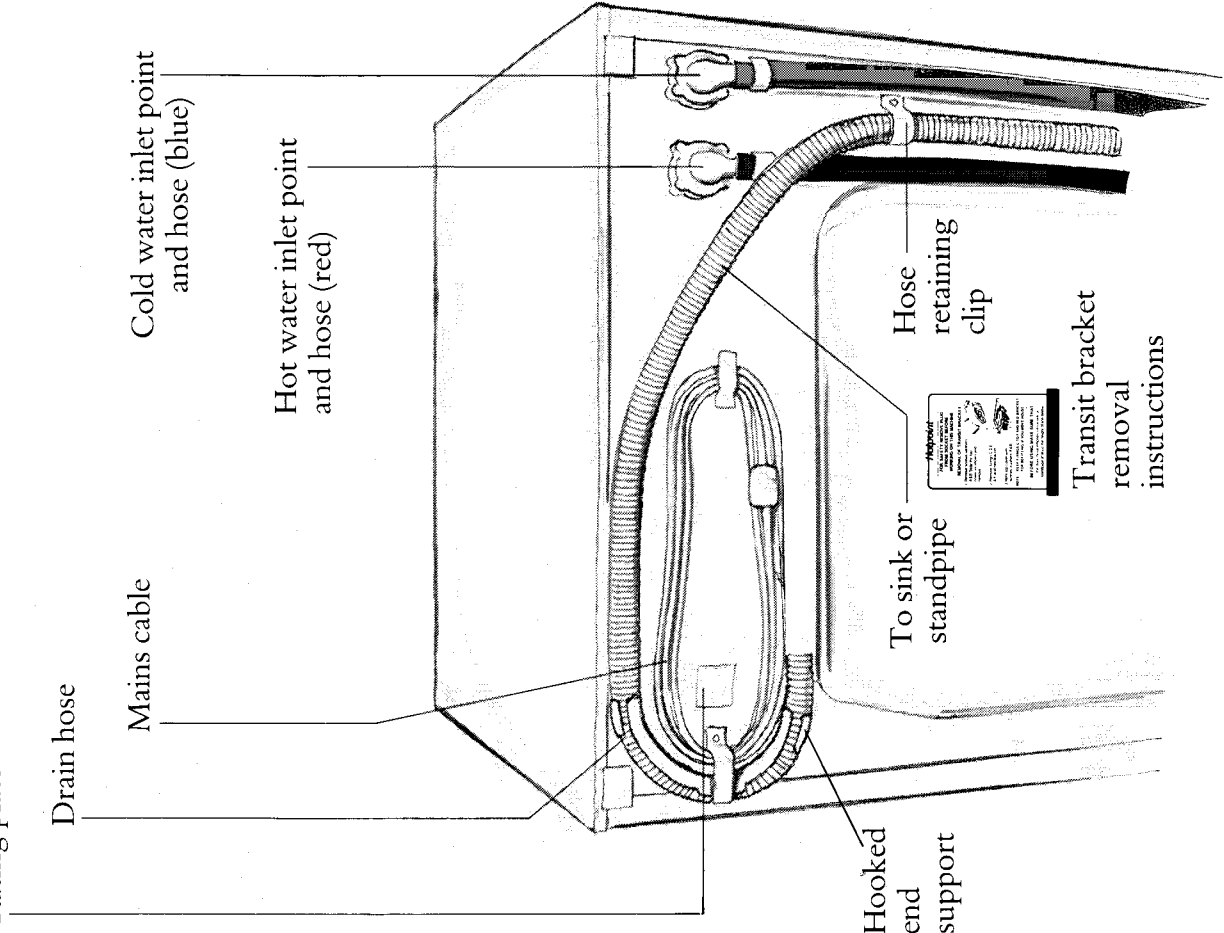

Getting the laundry ready

Sorting.

To get the best results, different fabrics need to be washed in different ways.

Laundry should be sorted according to the International Textile Care Labelling (ITCL) codes which appear on the labels on most laundry items. It is also a good idea to separate light and dark colours.

The ITCL codes are also used in the Programme Guide (page 12), on the Programme Selector (page 14) and on the sides of washing powder packets.

Mixed fabric loads.

If you do not have sufficient items to make up a full or half load you can combine fabrics as follows:

ITCL codes **1** and **2** : wash as code **2**
ITCL codes **3** and **4** : wash as code **4**
ITCL codes **2** and **5** : wash as code **5**

Lightly soiled natural and synthetic fabrics (codes **1** to **6**) can be mixed and washed on programme **6**. However, the load must be restricted to 1.8kg (4lb).

Note: Non colourfast items, woollens and heavily soiled washing should not be washed in a mixed load.

Pre-treatment of heavy soiling and stains.

Brushing a little washing powder dissolved in water onto things like heavily soiled collars and cuffs will help to shift the dirt.

The secret of dealing with stains is immediate treatment. When an accident happens, plunge the stained area into **cold** water or sponge it down. This prevents the stain from setting. Wash as soon as possible after this.

When washing nappies where baby creams such as Vaseline have been used always scrape off the excess cream before washing. In addition, using a Pre-Wash before the Main Wash (page 14) is recommended to prevent the cream from being re-deposited on the washing.

Pockets and zips.

Turn out all pockets to ensure that they are empty. Coins, penknives, keys, etc., can cause internal damage to your machine.

Also, close all zips and tie belts and strings to avoid tangling.

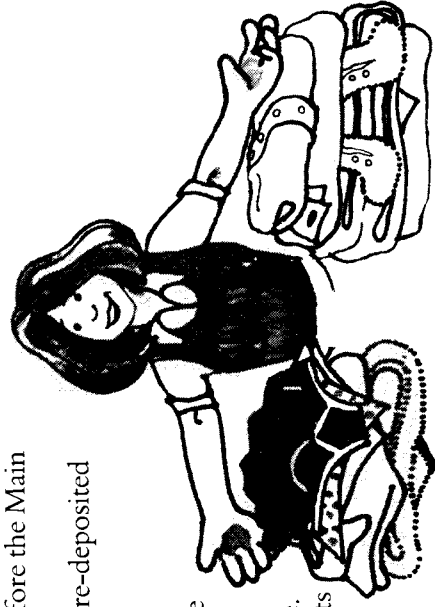

What to do if your machine goes wrong

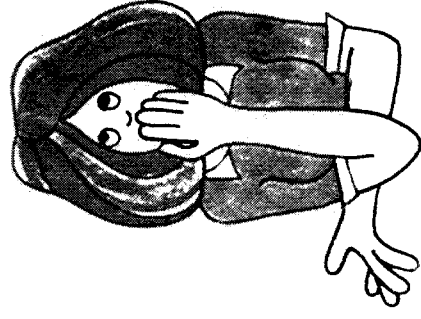

Firstly, don't panic! Experience has shown us that most common 'faults' can be easily cured by following this step by step checklist. Simply read down the list until you find your problem and then follow the advice given.

If you still cannot get your machine to work, follow the advice given under 'What Next?' at the end of the checklist.

Problem

The dispenser drawer won't open or close completely.

Checklist

Make sure that the flap is fitted correctly. Refer to page 18.

It won't start.

Make sure that:

The machine is plugged in and switched on at the socket.

The Programme Selector is pulled out.

The door is securely closed.

The water supply is turned on.

The hoses are not kinked.

The fuses in the plug and main fuse box are OK. Try plugging in another appliance to check. If the fuse has blown refer to the Electrical Requirements section of the Installation Instructions booklet.

It won't fill.

Make sure that:

The water supply is turned on.

The hoses are not kinked.

The door is securely closed.

The inlet filters are not blocked. To check turn off the water, unscrew the inlet hoses from the back of the machine and you will see the filters. Clean them under a tap and replace them. Refit the hoses carefully, hand tighten only. This is quite sufficient to avoid leaks.

Caring for your machine

Your machine needs very little attention. The following simple steps will keep it performing well.

After Each Wash: Rotate the drum by hand to check that small things like handkerchiefs do not get missed.

When Finished: Press in the Programme Selector, turn off the water and disconnect the electricity.

Weekly: Wipe out the drum with a damp cloth.

Remove the powder dispenser and clean (see below) in warm water only.

As Necessary: Clean metal and plastic surfaces with a damp cloth or silicon polish only. Do not use abrasive cleaners, scouring agents, acids, chlorine bleach or metal polishes to clean any part of your machine, they could cause damage.

Yearly: We recommend you take out a Maintenance Plan which ensures the machine is professionally serviced every year. Details are given at the end of this book.

Removing and cleaning the powder dispenser drawer.

To remove the dispenser drawer for cleaning, pull out until the stop is reached. Push it back in about 25 mm (1 in) and then, lifting slightly, pull out smartly.

Check that the flap at the back of the drawer is located correctly and pivots freely.

To reassemble, locate the drawer slides into the machine – check that the flap is in the closed position by holding the top away from you (see diagram) until it locates under the top of the dispenser opening. Now push the drawer back in firmly, making sure that it closes completely. (A slight resistance may be felt just after the flap has entered the dispenser opening – this is normal.)

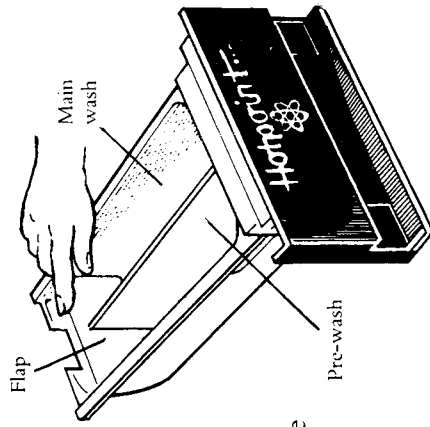

ITCL codes explained

These other types of ITCL codes are often found on garment labels. This is what they mean:

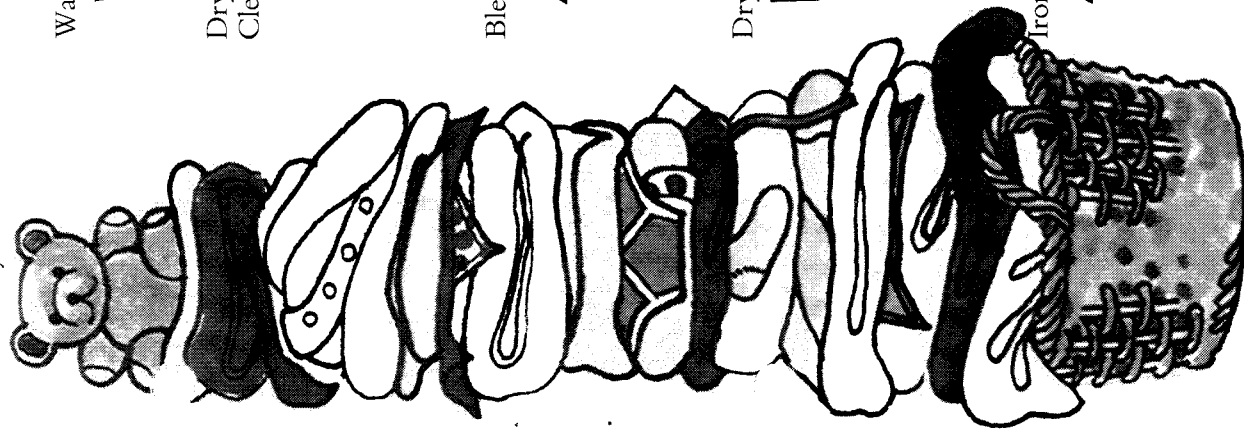

- Washing: Hand wash only – e.g. glass fibre curtains and washable pleated garments containing synthetics.
- Do not wash (even hand wash): Do not wash (even hand wash).
- Dry Cleaning: All of these are dry cleaning symbols. The letters are to instruct the cleaner what type of solvent should be used. **Garments bearing these symbols should not be washed in your machine, unless the label says otherwise.**
- Bleaching: Bleach may be used. In this case the letters 'CL' show that a chlorine household bleach such as 'Domestos' can be used. NB This applies to hand washing only. **Do not use bleach in your machine.**
- Drying: Do not bleach.
- Tumble drying is beneficial.
- Do not tumble dry.
- Drip dry.
- Hang/line dry.
- Dry flat.
- Ironing: Cool iron.
- Warm iron.
- Hot iron.
- Do not iron.

How to load the laundry

Your machine washes by gently lifting the clothes out of the water and dropping them back into it. If you overload your machine, this tumbling action will be hampered and the clothes will not be properly cleaned.

A rough guide to a full load of dry clothes is:

Cottons – 4.1 kg (9lb) drum full to the top, but not tightly packed.

Synthetics – 1.8kg (4lb) drum two thirds full.

If the clothes are wet, the drum should only be half full for cottons and a third full for synthetics.

Additional tips.

- Blankets, double bedspreads and other bulky articles should be washed one at a time. To load a blanket hold it by the centre allowing the corners to fall to the floor. Feed the centre of the blanket into the machine, allowing the rest to follow with the corners coming last.
- Towels, nappies and other highly absorbent loads should be limited to 3kg (7lb) per load to ensure adequate rinsing.

Guide to weights of clothes:

	gm	lb
Double sheet	700-1000	1½-2¼
Single sheet	450-700	1-1½
Pillow slip	100	¼
Bath towel	450-700	1-1½
Tea towel	100	¼
Table-cloth	350-450	¾-1
Pyjamas	350-450	¾-1
Shirt	200-350	½-¾
Men's underwear	100-200	¼-½
Blouses, slips	100	¼
Children's dresses	100	¼
1 dozen nappies	1100	2½

The machine at work

Content of the programmes.

If you have not had an automatic before you may be puzzled by what the machine is doing as it stops and starts, fills and empties. Rest assured, all of its actions are carefully planned to give you the best possible wash.

In brief, this is what it will do:

- Fill with water, tumbling to mix washing powder.
- Heat to required temperature, with an occasional gentle tumble.
- Wash by tumbling, stopping and reverse tumbling for a set length of time.
- Cool rinses. Note that on synthetic programmes **3**, **4** and **6**, the first rinse has a stepped cool down feature by which cold water is added to the hot wash water to gradually reduce its temperature and prevent shock creasing of the washing.
- Rinse Hold on the final rinse of programmes **3**, **4** and **6** is an optional feature, explained on page 15. If Rinse Hold has been selected the machine will stop at this point on the final rinse. To continue, press and release the Rinse Hold button.

f) Spins. Each rinse is followed by a series of spins to remove rinse water and minimise creasing, so don't worry when you hear changes in spin speeds.

g) Fabric conditioner, if required can be used after the wash programme is completed (see page 11).

Remember that the whole point of an automatic is that it works completely on its own – automatically! Just leave it to it and do something else – like putting your feet up.

How long do programmes take?

Programme times can vary quite a lot, the main reason being the temperature of your hot water. The hotter it is the less time the machine takes to heat up. If it is fairly cool – for example if someone has just had a bath – then the machine will take much longer to heat up.

The following is an approximate guide to wash programme times:

Programme	Time	Optional Feature Times
1	70-80 mins	Pre-Wash adds 30 minutes
2	60-65 mins	
3 5	50-55 mins	Economy Wash saves up to 15 minutes.
4 6 7	40-45 mins	

The controls (cont'd)

Rinsing and Spinning.

You can use your machine for spinning or rinsing/spinning hand washed items. All you have to do is select the right symbols on the Programme Selector just as you do for the main wash programmes.

There are three places on the Selector you can choose, two for robust natural fabrics and one for delicate synthetic fabrics. These are identified as follows:

- © Long Fast Spin Section – Natural fabrics
ITCL Codes **1**, **2**, **5** and **7**.
- © Short Slow Spin Section – Synthetic fabrics
ITCL Codes **3**, **4** and **6**.

The 'Long Fast Spin' is at 800rpm, and the 'Short Slow Spin' is at 500rpm with a quick burst of 800rpm at the end.

To Spin only:

1. Switch on the power supply to the machine.
2. Open the door and load the items singly. Do not fill the drum more than half full.
3. Close the door firmly to engage the safety latch with a click.
4. Push in the Programme Selector and turn it clockwise until the correct spin symbol © or © is at 12 o'clock position. Pull out the Selector to start the machine.

To Rinse and Spin:

1. Switch on the power and water supply to the machine.
2. Open the door and load the items singly. Do not fill the drum more than half full.
3. Close the door firmly to engage the safety latch with a click.
4. Push in the Programme Selector and turn it clockwise until the rinse symbol ⌘ (which is found just before the relevant spin symbol) is at the 12 o'clock position. Pull out the Selector to start the machine.

Note: Woollens and other Hand Wash Only  items should only be spin dried, but with all other washable fabrics it is advantageous to give them a rinse and spin.

Checklist.

Please refer to the Checklist on page 13 whenever you use your machine to ensure excellent results.

Special care for woollens

Garments with washable Woolmark and Washcare labels may be washed in your machine by selecting programme (see page 12).

Three very important points must be remembered when washing woollens:

1. **Restrict the load to 1.4kg (3lb).**
2. **Do not use a Pre-Wash, woollens should not be soaked.**
3. **Do not use a Tumble Dryer to dry woollens.**

Programme **7** is suitable for washable shrink-resistant, machine-washable and Superwash Woolmark garments. **Do not machine wash woollen garments which only have a wool symbol and no Washcare label or no labels at all.**

Note: Many 'woollies' are not made of wool but are acrylic and should be washed on programme **6**. Always check the label on the garment and if in doubt wash 'woollies' on Programme **6** not **7**.

There is a special built in 'Rock-a-Bye' wash action for woollens. When Programme **7** is selected the machine will automatically give a gentle tumble motion during the wash to prevent woollens becoming matted. 'Rock-a-Bye' is a special Hotpoint feature, and is approved by the International Wool Secretariat.

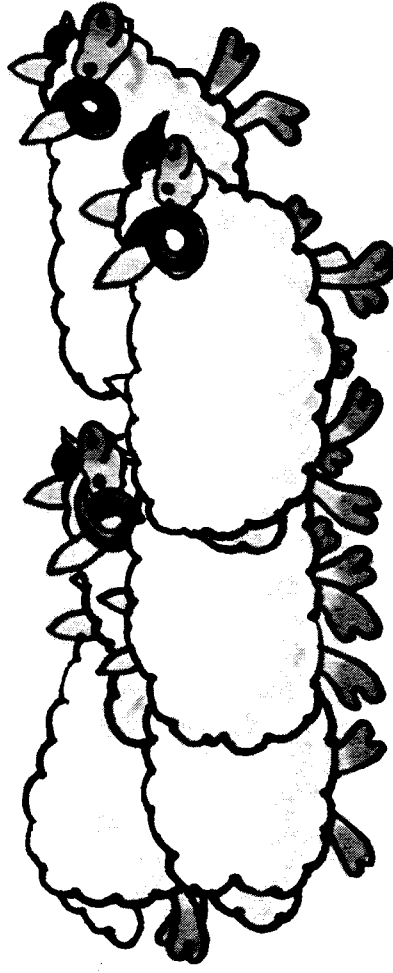

Getting the machine ready

Opening the door.

Now you have sorted your laundry, you can load the machine.

Open the door by pressing the Door Release button located in the centre of the door handle, and pulling the door open.

Place the sorted laundry into the drum.

Close the door firmly so that it clicks. This indicates that the safety latch has engaged. The safety latch remains engaged whilst there is water in the machine or the Programme Selector is pulled out, in the ON position.

Do not attempt to open the door once the wash programme has started.

NOTE: The door will be locked for about two minutes after the programme has finished or the Programme Selector knob has been pushed in and the machine is empty of water.

How to put the washing powder in.

The next step is to put in washing powder.

- What type of powder should be used?
Any low suds 'automatic' powder can be used. Your machine has been specially developed to take advantage of the cooler wash performance of the new low temperature biological powders, such as New System Persil Automatic. Ordinary washing powders produce excessive suds which reduce the washing performance and can overflow from the machine.

- How much powder should be used?

It is important to use the correct amount of powder; too little will not get the clothes clean, too much will be wasteful.

In the table opposite you will find standard recommendations for powder usage. Use these measures to start off with and amend them in the light of your own personal experience if necessary.

As a guide the right amount of powder produces a 25 mm (1 in) layer of suds at the end of the washing cycle.

- Which dispenser compartment should be used?

Open the dispenser drawer. Put the powder for the main wash into the right hand section marked 'Main Wash'. If you have very dirty clothes and want to do a pre-wash, put the powder into the left hand section, marked Pre-Wash.

Selecting optional wash features.

These are controlled by the two buttons on the Control Panel marked 'Rinse Hold' and 'Economy Wash'. They are both selected by pushing the button in. They are cancelled by pressing again so that the button becomes flush with the Control Panel.

ALWAYS REMEMBER TO CANCEL THEM AFTER USE.

Rinse Hold

When selected the machine stops during the final rinse at the red symbol **▶** on the Programme Selector, holding the clothes immersed in water until you are ready to spin them dry. This minimises creasing on synthetic fabrics. If required it should be pressed after you have selected the programme.

To restart the machine, when it has stopped on Rinse Hold, simply press and release the 'Rinse Hold' button. The machine will then complete the Final Rinse and Spin.

Note: Rinse Hold will only operate on the synthetic fabric programmes **[3]**, **[4]** and **[6]**.

Economy Wash

Economy Wash enables you to wash lightly soiled laundry at the temperature of the incoming water from your tank.

When this wash feature is selected the machine's heating element is switched off, thus saving you time and money.

Economy Wash can be used on any programme including Pre-Wash, but **remember that it should only be used on lightly soiled loads and will wash at the temperature of the incoming water.**

NOTE: If you do not want any of the wash features previously selected simply press and release the appropriate button to cancel it.

Quick Wash. If you want to quickly freshen up lightly soiled items, such as underwear, blouses and shirts, so that they can be worn again the next day, select Programme **[6]** and press the Economy Wash button. This will give a quick, cool wash in just over half an hour. Restrict the load to 1.8kg (4lb).



The controls

This section explains in detail how to programme your machine and what each of the features does.

The Control Panel is shown below.

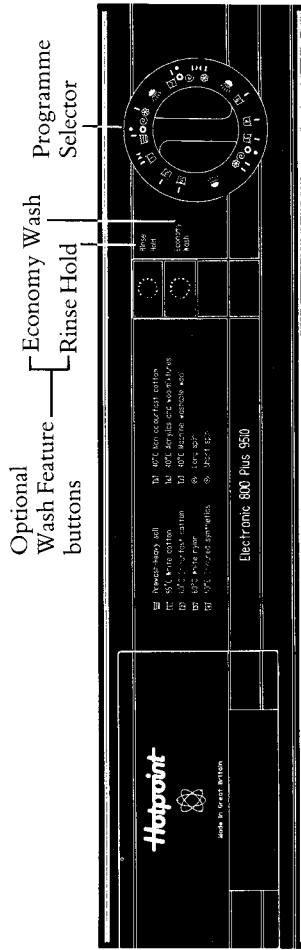

Switching on and off.

The Programme Selector, as well as giving you all the wash programmes, also switches the machine on and off.

The machine is **on** when the Selector is pulled **out**.

The machine is **off** when the Selector is pushed **in**.

Selecting a programme.

Programmes are selected by simply turning the Selector **clockwise** until the number you want is at the 12 o'clock position.



There are two things you must **not** do when using the Selector:

- **Do not turn the Selector when it is pulled out;** if you wish to reselect a programme remember to push in the Selector before turning.
- **Do not turn the Selector anti-clockwise;** if you overshoot your intended programme continue turning right around until the number comes up again.

Selecting a Pre-Wash.

A Pre-Wash should be used where the clothes are heavily soiled, examples being nappies and football kit.

A Pre-Wash can be used before any programme except the woollen programme .

To select a Pre-Wash, turn the Programme Selector until the Pre-Wash symbol  is at 12 o'clock position. When it has finished the machine will stop on the red mark , reset the Selector to the ITCL programme required (remember to push it in before turning).

During the Pre-Wash the water is warmed thus enabling you to use Biological low lather powder most efficiently. If however, a Cold Pre-Wash is required simply press the Economy Wash button (see opposite).

	HARD WATER*		SOFT WATER*	
	Pre-wash (heavy soil) Cup	Main wash Cups	Pre-wash (heavy soil) Cup	Main wash Cups
One cup = 100 g (3½ oz) Measuring cups are provided in E10 & E20 packets of Persil Automatic	½	2-2½	½	1-1½
Full load	Do not pre-wash	1½-2	Do not pre-wash	¾-1
Machine Washable wool				

★**Note:** An easy way of checking water hardness is to look in your kettle. If it furs up, then you have hard water.

How to use fabric conditioner.

We recommend you use a fabric conditioner, for example, Comfort, as it will soften your washing, eliminate static cling from synthetics and make ironing easier.

Fabric conditioner may be added after the wash programme has been completed. Dilute 2-3 capfuls (or according to the manufacturer's instructions) in approximately one litre of cold water and add, via the left-hand side of the dispenser. Push the Programme Selector in and turn it clockwise until the last rinse position  on the programme just completed has been reached, pull the Programme Selector out to repeat the last rinse and spin dry, thus thoroughly dispersing the fabric conditioner.

Warning: Do not pull out the powder dispenser drawer at any time when the machine is operating.

Cleaning the dispenser drawer.

We recommend that you clean out the dispenser drawer every week. This helps to avoid powder sticking. (See page 18).

Lockable dispenser drawer.

A brown lockable drawer (Part no. 168476) is available from your local Hotpoint Service Centre (see Back Page) using the accessories order form enclosed. This is particularly useful if you have young children as it prevents them either opening the drawer when the machine is working or hiding objects in the drawer when not in use.

Wash Programme Guide

This guide corresponds to the seven main programme instructions which you will find on washing powder packets and on most washable clothes. It also corresponds to the numbers which appear on the Programme Selector of your front loader. The international labels add the temperature to the wash programme number, but all you need to bother with is the number.

Symbol/ Programme Number	Fabric	Wash Temperature °C	Maximum Full Load	Pre-Wash	Optional Wash Features	
					Rinse Hold	Economy Wash
	White Cotton and linen without special finishes	85	4.1 kg 9 lb	Heavily soiled laundry only	Will not operate	Lightly soiled laundry only
	Colourfast cotton, linen or viscose without special finishes	60	4.1 kg 9 lb	Heavily soiled laundry only	Will not operate	Lightly soiled laundry only
	White nylon, white polyester/cotton mixtures	60	1.8 kg 4 lb	Heavily soiled laundry only	Press to minimise creasing	Lightly soiled laundry only
	Coloured nylon polyester acrylic/cotton mixtures, cotton or viscose with special finishes (eg. drip dry), coloured polyester/cotton mixtures	50	1.8 kg 4 lb	Heavily soiled laundry only	Press to minimise creasing	Lightly soiled laundry only
	Non-colourfast cotton, linen and viscose	40	4.1 kg 9 lb	Heavily soiled laundry only	Will not operate	Lightly soiled laundry only
	Acrylics, acetates and tri-acetates, blends of these fabrics with wool, polyester/wool blends	40	1.8 kg 4 lb	Heavily soiled laundry only	Press to minimise creasing	Lightly soiled laundry only
	Woolen blankets, wool mixtures with cotton or rayon, silk	40	2.7 kg 6 lb Wash Blankets singly	Do not use Pre-Wash	Will not operate	Lightly soiled laundry only
	Shrink-resistant machine-washable and Superwash Woolmark garments	40	1.4 kg 3 lb	Do not use Pre-Wash	Will not operate	Lightly soiled laundry only

Checklist

Follow the checklist whenever you use your machine and you will obtain excellent results each and every time:

1. Turn on the hot and cold water★. **Ref.** P6
2. Switch on the electricity. P8
3. Sort your laundry. P10
4. Load the machine. P14-15
5. Put in washing powder, including pre-wash if required. P15-16
6. Select programme. P14
7. Select optional features. P11
8. Pull Programme Selector out to switch on. P14
9. Put in fabric conditioner if required, when wash programme completed.
10. When programme is finished, push Programme Selector in to switch machine off. P14
11. Remove laundry.
12. Switch off electricity.
13. Turn off water.

★**Note:** if your machine is not permanently plumbed in you will need to connect up the inlet and drain hoses – see Installation Instructions booklet for details. The hot water supply should ideally be at 60°C (140°F) and should **not** be more than 70°C (160°F).