

PS760 Document Camera

User Manual

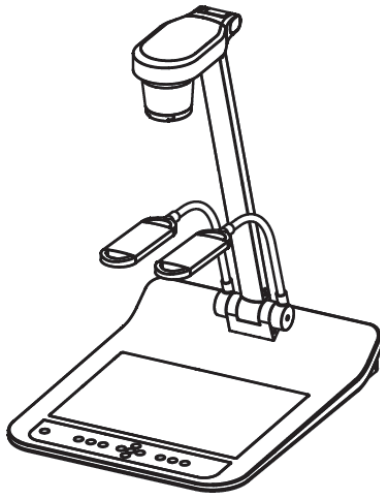

[Important]

To download the latest version of Quick Start Guide, multilingual user manual, software, or driver, etc., please visit Lumens™ <http://www.lumens.com.tw/goto.htm>

Table of contents

Copyright Information	4
Chapter 1 Safety Instructions	5
Precautions	6
FCC Warning.....	6
EN55022 (CE Radiation) Warning	6
Chapter 2 Package Contents	7
Chapter 3 Product Overview	8
3.1 Relative position of the presenter and document.....	8
Chapter 4 Installation and Connections	9
4.1 System diagram.....	9
4.2 Connecting to a projector or monitor	10
4.3 Connecting to a Computer and Use Lumens Software or an Interactive Whiteboard (IWB)	10
4.4 Connecting to Internet	11
4.5 Connecting to a Projector, 2 PCs, and a Monitor at the Same Time	11
4.6 Connecting to a TV (C-Video or S-Video)	12
4.7 Connecting to an HDTV	12
4.8 Connecting to DVD and display DVD images	13
4.9 Connecting to a Computer with RS232	14
4.10 Connecting to Audio Input and Output	14
4.11 Installing application software.....	15
Chapter 5 Start Using	16
Chapter 6 Control Panel/Remote Control and Setting Menu	17
6.1 Functions of control panel and remote control	17
6.2 Setting Menu	19

Chapter 7 Descriptions of major functions..... 26

7.1 I would like to automatically adjust the image to have best
brightness and focusing performance (Auto Tune) 26

7.2 I would like to switch image sources 26

7.3 I would like to set the image source of VGA OUT2 26

7.4 I would like to make text clearer and photos more colorful 27

7.5 I would like to zoom in/out images 27

7.6 I would like to adjust the focal length..... 27

7.7 I would like to adjust the brightness 28

7.8 I would like to turn on/off the lamp..... 28

7.9 I would like to freeze images 28

7.10 I would like to adjust the volume 28

7.11 I would like to capture images 29

7.12 I would like to record videos 30

7.13 I would like to view captured/recorded images 30

7.14 I would like to delete the captured/recorded images..... 31

7.15 I would like to automatically delete the stored images whenever
it is turned off (Auto Erase)..... 31

7.16 I would like to use the MASK and Spotlight function 31

7.17 I would like to enlarge a part of the image (PAN) 32

7.18 I would like to play the slides (Slide Show) 32

7.19 I would like to view the X-ray film 33

7.20 I would like to compare images (compare live images with stored
images (PIP))..... 33

7.21 I would like to reduce the image noise (Projector Type) 34

7.22 I would like to set the time for PS760 34

7.23 I would like to lock/unlock keys 35

7.24 I would like to resume the factory default settings (Factory Reset) .36

7.25 I would like to use a USB disk 36

7.26 Computer-related functions 36

7.27 I would like to use the network remote control function 40

Chapter 8 Connecting to Microscope 44

Chapter 9 DIP Switch..... 46

9.1 Connecting to a projector or monitor 46

9.2 Connecting to a TV/DVD 47

Chapter 10 Packing the Machine 48

Chapter 11 Troubleshooting 48

Chapter 11 Troubleshooting 49

Attachment 1 52

Copyright Information

Copyrights © Lumens Digital Optics Inc. All rights reserved.

Lumens is a trademark that is currently being registered by Lumens Digital Optics Inc.

Copying, reproducing or transmitting this file is not allowed if a license is not provided by Lumens Digital Optics Inc. unless copying this file is for the purpose of backup after purchasing this product.

In order to keep improving the product, Lumens Digital Optics Inc. hereby reserves the right to make changes to product specifications without prior notice. The information in this file is subject to change without prior notice.

To fully explain or describe how this product should be used, this manual may refer to names of other products or companies, nevertheless without any intention of infringement.

Disclaimer of warranties: Lumens Digital Optics Inc. is neither responsible for any possible technological, editorial errors or omissions, nor responsible for any incidental or related damages arising from providing this file, using, or operating this product.

Chapter 1 Safety Instructions

Always follow these safety instructions when setting up and using the Document Camera:

1. Do not place Document Camera in tilted position.
2. Do not place the Document Camera on an unstable trolley, stand or table.
3. Do not use the Document Camera near water or source of heat.
4. Use attachments only as recommended.
5. Use the type of power source indicated on the Document Camera. If you are not sure of the type of power available, consult your dealer or local electricity company for advice.
6. Place the Document Camera on a place that it can be unplugged easily.
7. Always take the following precautions when handling the plug. Failure to do so may result in sparks or fire.
 - Ensure the plug is free of dust before inserting it into a socket.
 - Ensure that the plug is inserted into the socket securely.
8. Do not overload wall sockets, extensions leads or multi-way plug boards as this may cause fire or electric shock.
9. Do not place the Document Camera where the cord can be stepped on as this may result in fraying or damage to the lead or the plug.
10. Unplug the projector from the wall socket before cleaning. Use a damp cloth for cleaning. Do not use liquid or aerosol cleaners.
11. Do not block the slots and openings in the projector case. They provide ventilation and prevent the Document Camera from overheating. Do not place the Document Camera on a sofa, rug or other soft surface or in a built-in installation unless proper ventilation is provided.
12. Never push objects of any kind through cabinet slots. Never allow liquid of any kind to spill into the Document Camera.
13. Except as specifically instructed in this User Manual, do not attempt to operate this product by yourself. Opening or removing covers may expose you to dangerous voltages and other hazards. Refer all servicing to licensed service personnel.
14. Unplug the Document Camera during thunderstorms or if it is not going to be used for an extended period. Do not place the Document Camera or remote control on top of heat-emitting equipment or heated objects such as a car, etc.
15. Unplug the Document Camera from the wall outlet and refer servicing to licensed service personnel when the following situations happen:
 - If the power cable or plug becomes damaged or frayed.
 - If liquid is spilled into it or the Document Camera has been exposed to rain or water.





<Note> Using an incorrect battery type in the remote control may result in breakdown. Follow your country's instructions on how to dispose of used batteries.

■ Precautions

Warning: To reduce the risk of fire or electric shock, do not expose this appliance to rain or moisture.

This Document Camera has a 3-wire AC line Plug. This is a safety feature to ensure that the plug will fit into the power outlet. Do not try to disable this safety feature.

If the Document Camera will not be used for an extended time, unplug it from the power socket.

	<table border="1"> <tr><td>Note</td></tr> <tr><td>Risk of Electric Shock</td></tr> </table>	Note	Risk of Electric Shock	
Note				
Risk of Electric Shock				
<p>Note: To reduce the risk of electric shock, do not remove cover (or back). No user-serviceable parts inside. Refer servicing to licensed service Personnel only.</p>				
	<p>This symbol indicates that this equipment may contain dangerous voltage which could cause electric shock.</p>			
		<p>This symbol indicates that there are important operating and maintenance instructions in this User Manual with this unit.</p>		

■ FCC Warning

This equipment has been tested and found to comply with the limits for a Class A or B digital device, pursuant to Part 15 of FCC Rules. These limits are designed to provide reasonable protection against harmful interference in a residential installation.

■ EN55022 (CE Radiation) Warning

This product is intended for use in a commercial, industrial, or educational environment. It is not intended for residential use.

This is a Class A product. In a domestic environment it may cause radio interference, in which case the user may be required to take adequate measures. The typical use is in a conference room, meeting room or auditorium.

Chapter 2 Package Contents

PS760

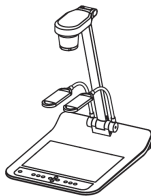

Quick Start Guide

(For download of other language versions, please visit Lumens website)

Quick Start Guide



4-Step Card
(Note to Teacher)



Download and Safety Instruction



USB Cable



Audio Cable

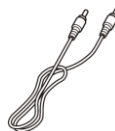

VGA Cable



Mini-DIN Adapter



Power Cord



Appearance may vary depending on country/region

Power Adapter

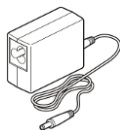

Remote Control



Remote Control Holder

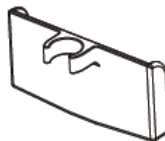

Microscope Adapter



Chapter 3 Product Overview

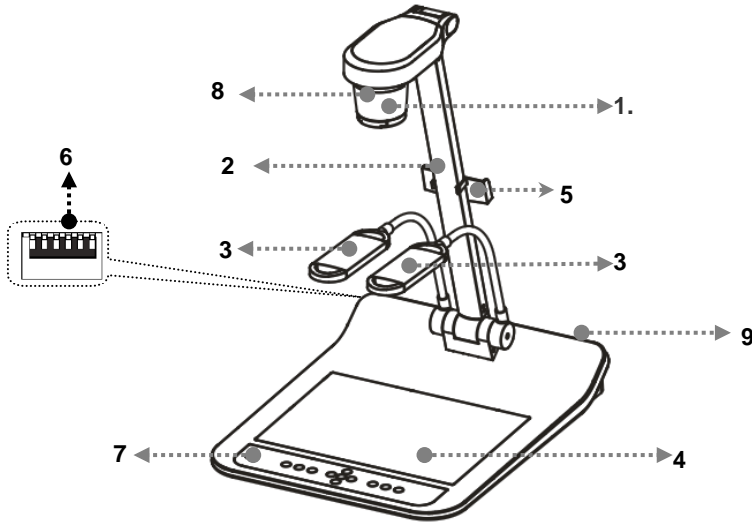

- 1. Lens
- 2. Camera arm
- 3. Auxiliary floodlight and lamp arm
- 4. Backlight
- 5. Remote Control Holder
- 6. DIP Switch
- 7. Control panel
- 8. Remote sensor
- 9. Input/output port

3.1 Relative position of the presenter and document

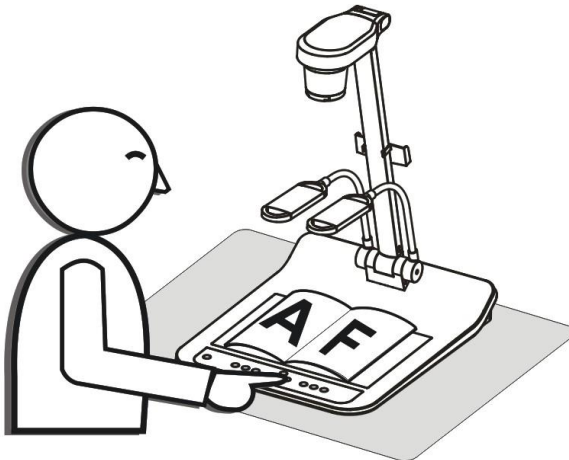

Chapter 4 Installation and Connections

4.1 System diagram

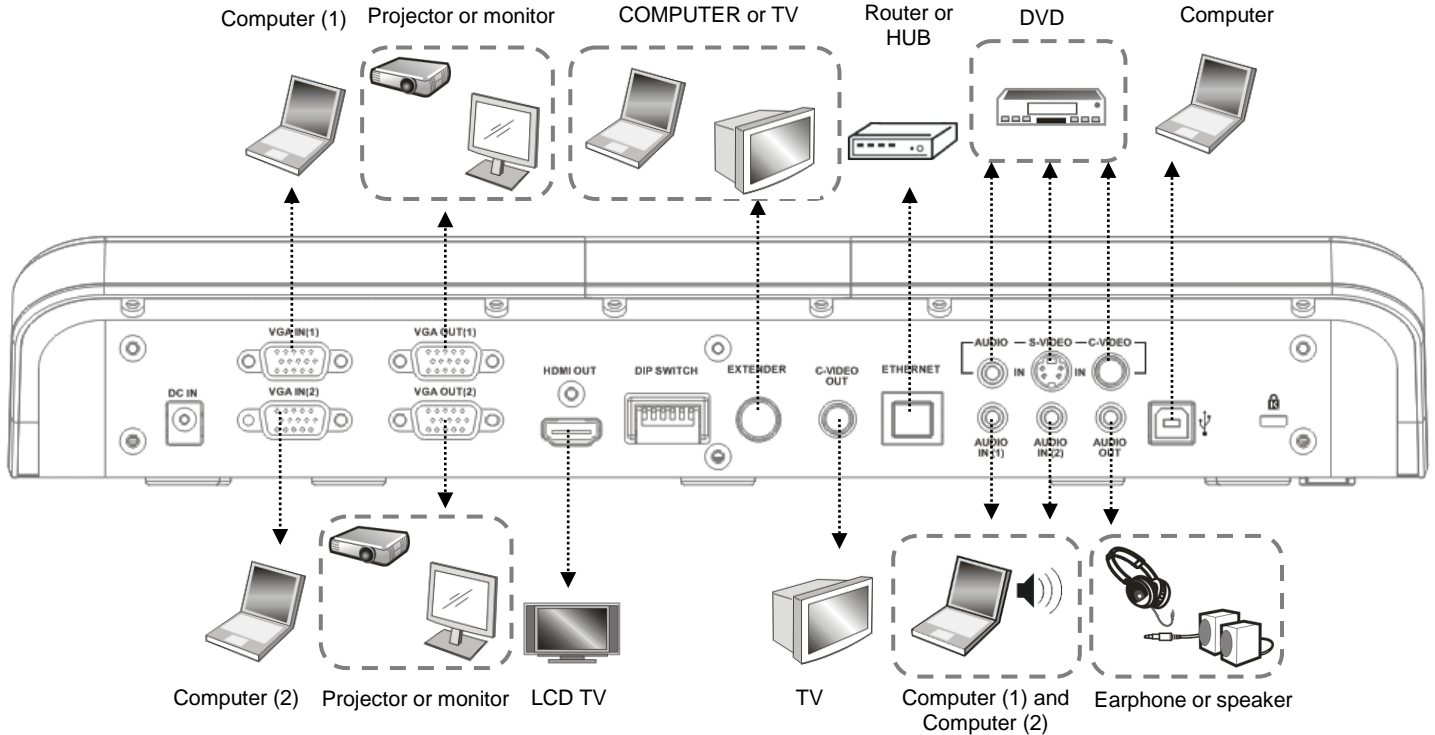

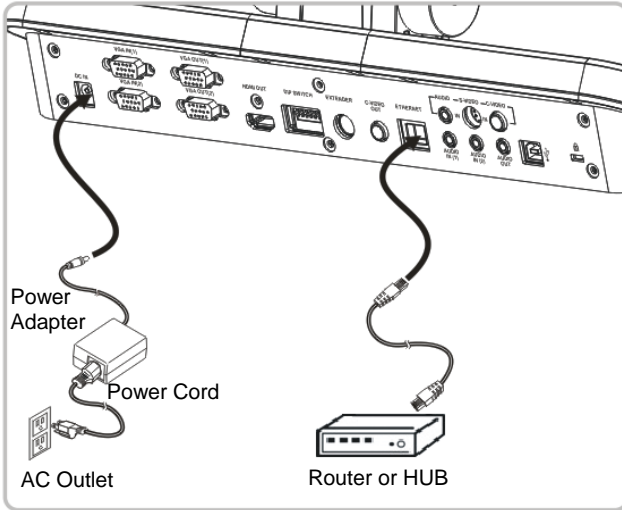

4.4 Connecting to Internet

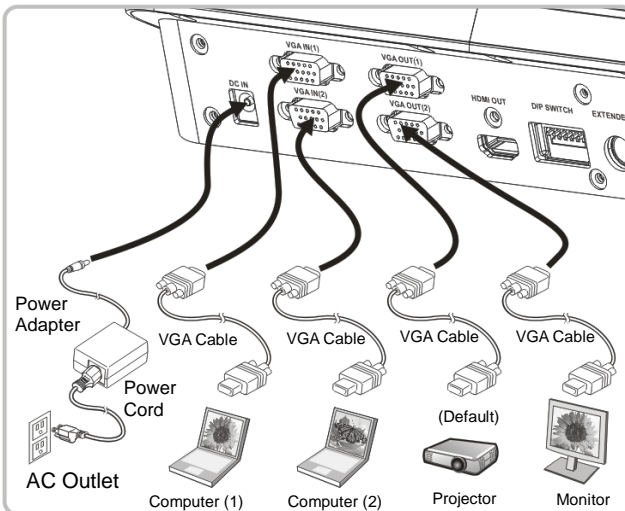

- For the related setting, please refer to [7.26 I would like to use the network remote control function.](#)

4.5 Connecting to a Projector, 2 PCs, and a Monitor at the Same Time



- Press  button to switch the image source.
- For VGA 1 setting, refer to [7.2 I would like to switch image sources.](#)
- For VGA 2 setting, refer to [7.3 I would like to set the image source of VGA OUT2.](#)

4.6 Connecting to a TV (C-Video or S-Video)

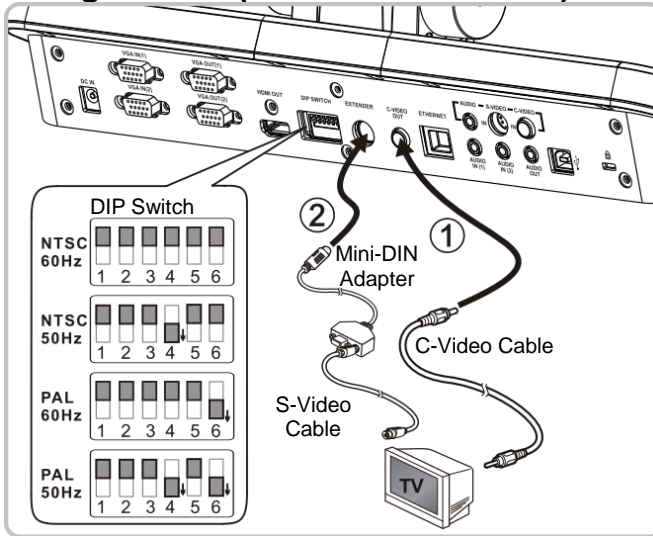

- NTSC: USA, Taiwan, Panama, Philippines, Canada, Chile, Japan, Korea, and Mexico.
 - PAL: Countries/regions not listed above.
 - Please adjust it to be suitable for the local voltage frequency of 50/60Hz. For the frequency in actual use, please refer to the manual. ([Attachment 1](#))
- <Note> You should unplug and reconnect the power cord, and then restart the machine for DIP Switch Settings to take effect.**

4.7 Connecting to an HDTV

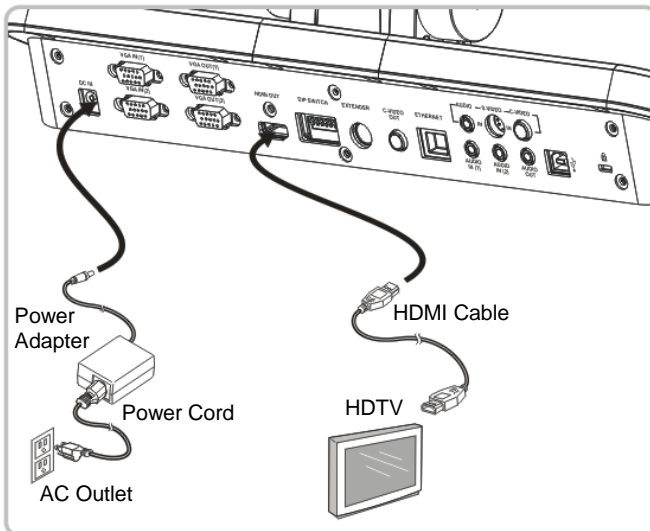

4.8 Connecting to DVD and display DVD images

- Press  button to switch the image source.
- For VGA 1 setting, refer to [7.2 I would like to switch image sources.](#)
- For VGA 2 setting, refer to [7.3 I would like to set the image source of VGA OUT2.](#)

4.8.1 C-Video

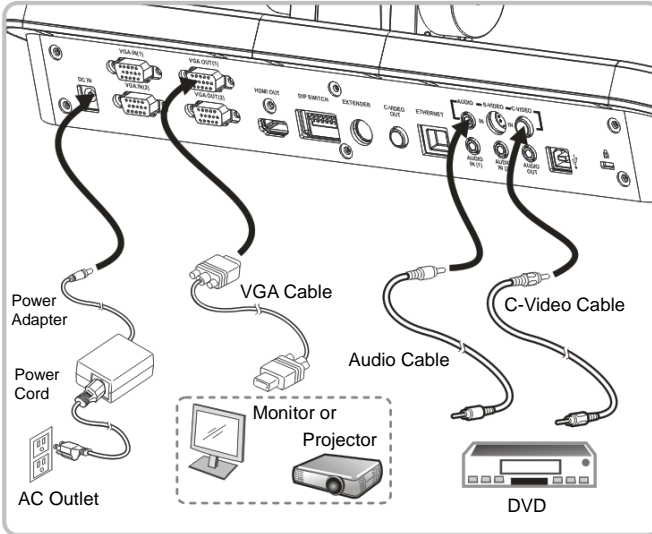

4.8.2 S-Video

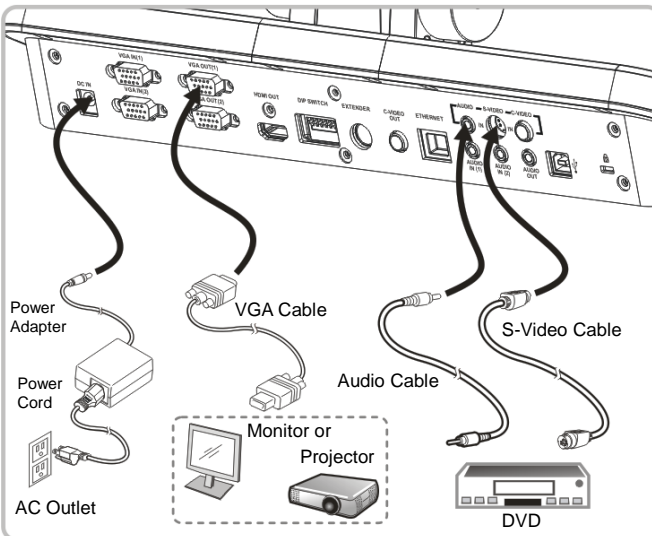

4.9 Connecting to a Computer with RS232

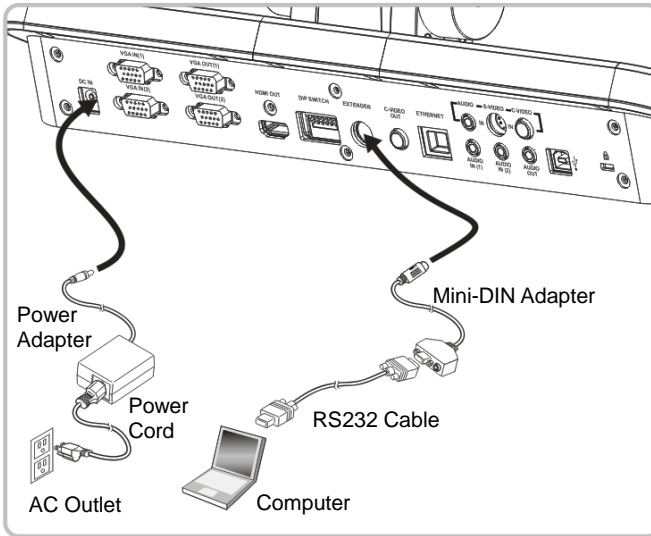

4.10 Connecting to Audio Input and Output

<Remark> The default of Audio Output is based on VGA OUT(1).

<Remark> Or connect to an additional amplifier before connecting to the speaker.

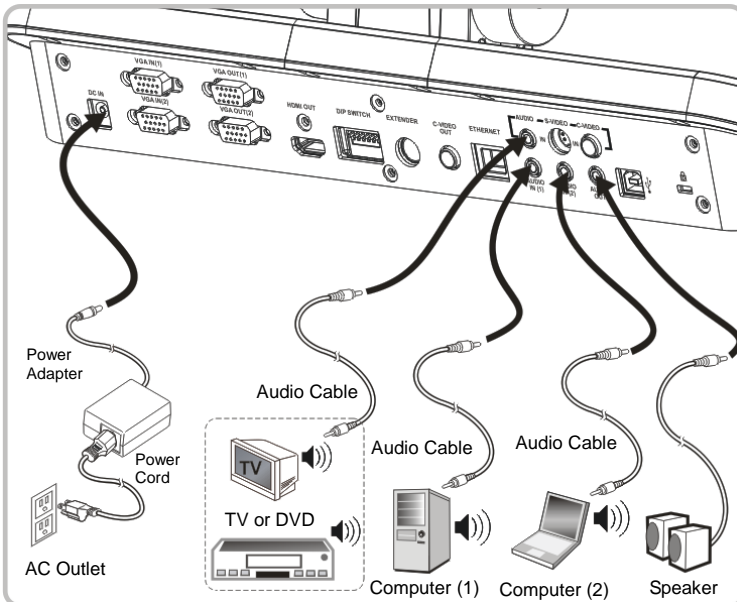

4.11 Installing application software

The application software installed on the computer enables you to:



- Control the PS760.
- Capture and record images.
- Annotate the image, highlight important details and save it.
- Support the full screen function.

<Note> Please refer to Podium View™ software user manual for installation steps and software operation.

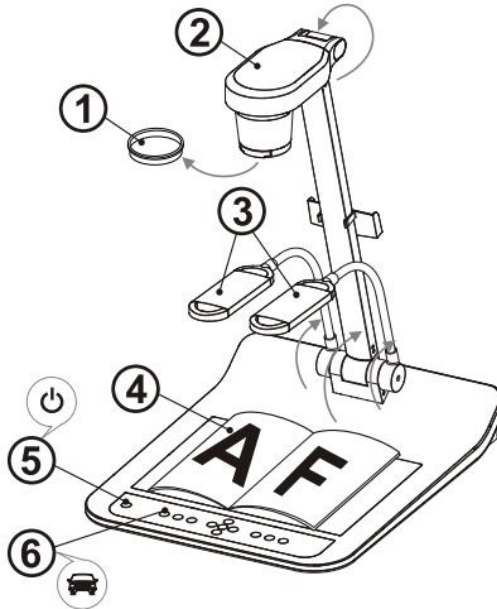
Chapter 5 Start Using



<Note>: Please adjust it to be suitable for the local voltage frequency of 50/60Hz. For the frequency in actual use, please refer to the manual. ([Attachment 1](#))

1. Remove the lens cap.
2. Pull up the camera and the camera arm. The camera should aim at the center of the presenter.
3. Pull up the lamp arm to a proper position.
4. Place an object to be displayed under the camera.
5. Press [POWER]  button to turn on the power. **(Remark: Do not press [POWER] button until the red light stays lit)**
6. Press [AUTO TUNE]  button to optimize the image. You are ready to teach/present.

<Note>: According to your request, you can adjust the camera head slightly to aim at the center of the documents when the anchor of lens was reached.

- When using the remote control, aim at the remote sensor on the DC190, and press the power button.
- Once PS760 is turned on, the LED indicator on the control panel will light up red. Please contact your dealer if the LED is not on.

Chapter 6 Control Panel/Remote Control and Setting Menu

6.1 Functions of control panel and remote control

<Remark> The below functions are listed alphabetically.

Name	Function Descriptions	Operation
	Turn on and off the Document Camera.	Remote control/ Control panel
◀, ▶, ▲, ▼	Move up, down, left or right to select the needed function.	Remote control/ Control panel
AUTO TUNE	Automatically adjust the image to have the best brightness and focusing performance. Press and hold the button on the control panel for 2 seconds to lock/unlock keys (for control panel only).	Remote control/ Control panel
BRT+/-	Manually adjust the brightness of the image.	Remote control/ Control panel
CAPTURE	Capture images to the USB disk (priority) or internal memory.	Remote control/ Control panel
DELETE	Delete images from the USB disk (priority) or internal memory.	Remote Control
ENTER	Enter/Activate functions.	Remote control/ Control panel
FREEZE	Freeze the current image to temporarily stay on the screen. Press again to defreeze.	Remote control/ Control panel
LAMP	Turn on/off the lamp.	Control panel
MASK	Enter Mask/Spotlight mode.	Remote Control
MENU	Activate the setting menu/exits the menu.	Remote control/ Control panel

PAN	Enable/Disable the Partial Enlarged mode.	Remote Control
PIP	Image comparison (compares live images with captured image files).	Remote Control
PLAYBACK	Read files stored in the USB disk (priority) or internal memory.	Remote Control
RECORD	Record motion images. Press [RECORD] to record images to USB disk (priority) or internal memory, and then press [RECORD] again to stop recording.	Remote Control
SLIDE SHOW	Show the photos or videos stored in the USB disk (priority) or internal memory in Slide mode.	Remote Control
VGA 1	Switch between different image sources of VGA 1 . Visual Presenter/VGA IN(1)/VGA IN(2)/DVD.	Remote control/ Control panel
ZOOM +/-	Increase or decrease the image size.	Remote control/ Control panel

6.2 Setting Menu

6.2.1 Main Menu:

<Remark> Press **[Menu]** on the **remote control** or **control panel** to enter the **setting menu**; The **bold underlined** values in the following table are defaults.

1 st Level Major Items	2 nd Level Minor Items	3 rd Level Adjustment values	Function Descriptions
Display	Auto Tune	<u>Enter</u>	Automatically adjust the image to have the best brightness and focusing performance.
	Auto Focus	<u>Enter</u>	Automatically adjust the focal length of image.
	Focus	0~ <u>A</u> ~Max	Use the left and right arrow keys to adjust focal length on an object.
	Brightness	0~ <u>A</u> ~Max	Use the left and right arrow keys to adjust the brightness.
	Rotate	1. <u>0°</u> 2. 90° 3. 180° 4. 270°	Rotate the image by 0°/90°/180°/270°.
	Mode	<u>Normal</u> /Slide/ Film/Microscope	Use the left and right arrow keys to select the image mode.
	Photo/Text	<u>Photo</u> /Text/Gray	Use the left and right arrow keys to select the image mode.
	Mask	<u>Enter</u>	Press [ENTER] to enter the MASK Mode. For details, please refer to 6.2.2 MASK Mode Setting Menu and 6.2.3 Spotlight Mode Setting Menu .
	Night Vision	On/ <u>Off</u>	Use the left and right arrow keys to select. The night vision mode suits with darker environment.

1 st Level Major Items	2 nd Level Minor Items	3 rd Level Adjustment values	Function Descriptions
Storage	Slide Show	<u>Enter</u>	Press [ENTER] to show the photos or videos stored in the USB disk (priority) or internal memory in Slide mode.
	Playback	<u>Enter</u>	Press [ENTER] to enter the thumbnail mode of image.
	Delay	1. 0.5 Sec 2. <u>1 Sec</u> 3. 3 Sec 4. 5 Sec 5. 10 Sec 6. Manual	Use the left and right arrow keys to select the delay time. Select manual mode to switch images manually.
	Image Quality	1. High 2. <u>Medium</u> 3. Low	Use the left and right arrow keys to select the image quality for the captured images and recorded videos.
	Copy To USB Disk	Yes/ <u>No</u>	Press [ENTER] to immediately copy the data in internal memory to the USB Disk.
	Delete All	Yes/ <u>No</u>	Use the left and right arrow keys to select, press [ENTER] to confirm the deletion of all images from the USB disk (priority) or internal memory.
	Format	Yes/ <u>No</u>	Use the left and right arrow keys to select, and then press [ENTER] to format the USB disk (priority) or internal memory.
	Auto Erase	On/ <u>Off</u>	Use the left and right arrow keys to turn on/off the auto erase function. When "On" is selected, the stored images will automatically be deleted when the system is turned off.

1 st Level Major Items	2 nd Level Minor Items	3 rd Level Adjustment values	Function Descriptions
Setting	Capture Action	1. Single 2. Continuous shooting 3. Disable	Use the left and right arrow keys to select the capture mode. (Single/Continuous/Video/Disable) <Note> The image cannot be captured when the capture mode is set to [VIDEO].
	Capture Mode	Photo /Video	Use the left and right arrow keys to select CAPTURE setting.
	Capture Time	1. 1 hr 2. 2 hr 3. 4 hr 4. 8 hr 5. 24 hr 6. 48 hr 7. 72 hr	Use the left and right arrow keys to select the capture time. <Note> It only works when the capture mode is set to [continuous].
	Capture Interval	1. 5 Sec 2. 10 Sec 3. 30 Sec 4. 1 Min. 5. 2 Min. 6. 5 Min.	Use the left and right arrow keys to select the capture interval. <Note> It only works when the capture mode is set to [continuous].
	Auto Exposure	On/Off	Regardless of outside environment, the machine will adjust the brightness to the optimal condition. Use the left and right arrow keys to select.
	White Balance	Enter	Regardless of outside light or color, the machine will adjust the color to the optimal condition; Press [ENTER] to activate.
	Volume	0~ A ~Max	Use the left and right arrow keys to adjust the volume.
	Projector Type	DLP/ LCD	Use the left and right arrow keys to select the projector type and reduce image noise.
	Digital Zoom	On/Off	Use the left and right arrow keys to turn on/off digital zoom .

1 st Level Major Items	2 nd Level Minor Items	3 rd Level Adjustment values	Function Descriptions
Advanced	Ethernet	<u>Enter</u>	Press [ENTER] to show the Ethernet window. For details, please refer to 6.2.5 Ethernet Setting Menu .
	Language	<ol style="list-style-type: none"> 1. English 2. 繁體中文 3. Deutsch 4. Français 5. Español 6. Русский 7. Nederlands 8. Suomi 9. Polski 10. Italiano 11. Português 12. Svenska 13. ČESKY 14. 简体中文 	<p>English Traditional Chinese German French Spanish Russian Dutch Finnish Polish Italian Portuguese Swedish Czech Simplified Chinese</p> <p>Use the left and right arrow keys in the Language option to select the preferred language.</p>
	VGA OUT(2)	<ol style="list-style-type: none"> 1. VGA OUT(1) 2. VGA IN(1) 3. VGA IN(2) 4. DVD 	Use the left and right arrow keys to select the images output from VGA OUT(2).
	Date & Time	<u>Enter</u>	Press [ENTER] to show the Date & Time window. For details, please refer to 6.2.4 Date & Time Setting Menu .
	Lock Down	On/ <u>Off</u>	Use the left and right arrow keys to turn on/off the lock down function. You can set the password when [On] is selected.
	Preset Load	Yes/ <u>No</u>	Read the value of the current image mode. Use the left and right arrow keys to select, and then confirm by pressing [ENTER].
	Preset Save	Yes/ <u>No</u>	Store the value of the current image mode. Use the left and right arrow keys to select, and then confirm by pressing [ENTER].
	Factory Reset	Yes/ <u>No</u>	Use the left and right arrow keys to select, and then confirm by pressing [ENTER] to restore the factory defaults.

6.2.2 MASK Mode Setting Menu

1 st Level Major Items	2 nd Level Minor Items	3 rd Level Adjustment values	Function Descriptions
Mask Mode	Transparency	0~ <u>4</u> ~6	Adjust the transparency of the mask using left and right arrow keys.
	Step	Large/ <u>Medium</u> /Small	Select the step distance of the mask using left and right arrow keys.
	V Size	0~ <u>A</u> ~Max	Adjust the vertical height of the mask using left and right arrow keys.
	H Size	0~ <u>A</u> ~Max	Adjust the horizontal length of the mask using left and right arrow keys.
	Spotlight	<u>Activate</u>	Press [ENTER] to enter the Spotlight mode.

6.2.3 Spotlight Mode Setting Menu

1 st Level Major Items	2 nd Level Minor Items	3 rd Level Adjustment values	Function Descriptions
Spotlight Mode	Transparency	0~ <u>4</u> ~6	Adjust the transparency of the border in the Spotlight mode using left and right arrow keys.
	Step	Large/ <u>Medium</u> /Small	Select the step distance of the spotlight zone using left and right arrow keys.
	V Size	0~ <u>A</u> ~Max	Adjust the height of the spotlight zone using left and right arrow keys.
	H Size	0~ <u>A</u> ~Max	Adjust the width of the spotlight zone using left and right arrow keys.
	Live	<u>Activate</u>	Press [ENTER] to return to live image.

6.2.4 Date & Time Setting Menu

1 st Level Major Items	2 nd Level Minor Items	3 rd Level Adjustment values	Function Descriptions
Date & Time	Year	00~36	Press [ENTER] to modify the values using left and right arrow keys.
	Month	01~12	Press [ENTER] to modify the values using left and right arrow keys.
	Date	01~31	Press [ENTER] to modify the values using left and right arrow keys.
	Hour	00~23	Press [ENTER] to modify the values using left and right arrow keys.
	Minute	00~59	Press [ENTER] to modify the values using left and right arrow keys.

6.2.5 Ethernet Setting Menu

1 st Level Major Items	2 nd Level Minor Items	3 rd Level Adjustment values	Function Descriptions
Ethernet	DHCP	<u>On/Off</u>	Enable/Disable DHCP using left and right arrow keys.
	IP Address	<u>192.168.100.150</u>	Press [ENTER] to modify the values using left and right arrow keys.
	Netmask	<u>255.255.255.0</u>	Press [ENTER] to modify the values using left and right arrow keys.
	Geteway	<u>192.168.100.254</u>	Press [ENTER] to modify the values using left and right arrow keys.

6.2.6 Annotation Tools (Annotation)

After the mouse is connected, right click the mouse to start the tools.
 <Note> When the setting menu is activated, the tools cannot be used.

- Icon of Annotation



- Main Menu



- Free-hand Drawing Tool menu



Icon	Description
	Expand/Collapse the Annotation menu
	Open/Close the Free-hand Drawing Tool menu
	Select the line width
	Select pen color
	Clear all
	Free-hand drawing tool
	Draw a line
	Draw a rectangle
	Draw a polygon
	Draw an ellipse
	Eraser (Clear marks of free-hand drawing tool)

Chapter 7 Descriptions of major functions

7.1 I would like to automatically adjust the image to have best brightness and focusing performance (Auto Tune)

1. Press [AUTO TUNE] on the **remote control** or **control panel** to adjust automatically.

7.2 I would like to switch image sources

The default of image source is **Live Image**. Press **[VGA 1]** on the **remote control** or **control panel** to switch setting, and PS760 as well as audio output will switch among the following four modes in turn:

1. Live images (default)
2. VGA IN(1)
3. VGA IN(2)
4. DVD (C-Video/S-Video)

<Note> VGA IN mode will be switched to DVD mode automatically in turn when it is not connected to input equipment.

<Remark> This button is disabled in C-VIDEO Out mode.

7.3 I would like to set the image source of VGA OUT2

Press [MENU] on the **remote control** or **control panel** to enter the setting menu

1. Press [▶] or [◀] to the [Advanced] menu.
2. Press [▼] to enter [VGA OUT2].
3. Press [◀] or [▶] to select [VGA OUT(1)/VGA IN(1)/VGA IN(2)/DVD].
4. Press [MENU] to exit.

<Note> VGA IN mode will be switched to DVD mode automatically in turn when it is not connected to input equipment.

<Remark> If VGA OUT(1) is connected simultaneously, the audio output will be based on VGA OUT(1).

7.4 I would like to make text clearer and photos more colorful

7.4.1 Photo/Text mode descriptions

The default [Photo/Text] mode is in Photo (**Photo mode**). To change this setting, please use the **remote control** or the **control panel** to enter the Options of the Setting Menu.

- [Photo] (default): for viewing photos or text with photos, making photos more colorful.
- [Text]: for viewing text files, making the text clearer.
- [Gray]: for viewing black & white photos which will make the grayscale differentiation distinct.

7.4.2 Setting Photo/Text mode

To change the settings, please use the **remote control** or the **control panel**:

1. Press [MENU] to enter the setting menu.
2. Press [▶] or [◀] to select [Display].
3. Press [▼] to select [Photo/Text]. (Please refer to [7.4.1 Photo/Text mode descriptions](#) to make the best choice.)
4. Press [▶] or [◀] to select the [Photo/Text/Gray].
5. Press [MENU] to exit.

7.5 I would like to zoom in/out images

1. Press [ZOOM+] on the **remote control** or **control panel** to zoom in images.
2. Press [ZOOM-] on the **remote control** or **control panel** to zoom out images.

7.6 I would like to adjust the focal length

7.6.1 Auto Tracking

1. Press [MENU] on the **remote control** or **control panel** to enter the setting menu.
2. Press [▶] or [◀] to the [Display] menu.
3. Press [▼] to [AF button].
4. Press [ENTER] to activate AF button.
5. Press [MENU] to exit.

7.6.2 Manual Tracking

1. Press [MENU] on the **remote control** or **control panel** to enter the setting menu.
2. Press [▶] or [◀] to the [Display] menu.
3. Press [▼] to the [Focus].
4. Press [▶] or [◀] to adjust focal length.
5. Press [MENU] to exit.

7.7 I would like to adjust the brightness

1. Use **Remote Control** or **Control Panel** and press [BRT+] to make it brighter.
2. Use **Remote Control** or **Control Panel** and press [BRT-] to make it darker.

7.8 I would like to turn on/off the lamp

The default of the lamp is ON. When using the control panel:

1. Press [LAMP] to switch ON/OFF. (in the sequence of arm lamp/backlight/OFF)

7.9 I would like to freeze images

1. Press [FREEZE] on the **remote control** or **control panel** to freeze the current image on the screen.

7.10 I would like to adjust the volume

<Note> Volume control is intended to control the external audio output equipment only.

7.10.1 Adjust Volume (OSD)

1. Press [MENU] on the **remote control** or **control panel** to enter the setting menu.
2. Press [▶] or [◀] to the [Setting] menu.
3. Press [▼] to the [Volume].
4. Press [▶] or [◀] to adjust the volume.
5. Press [MENU] to exit.

7.10.2 Adjust the volume of the video

- In **PLAYBACK** mode, Press [▲] or [▼] to adjust the volume of the video.

7.11 I would like to capture images

7.11.1 Capturing and saving images

1. Press [CAPTURE] on the **remote control** or **control panel** to capture and save images.
- You cannot capture images when the capture mode is set to [Disable]. If it is set to [Continuous], you can capture images continuously. Press [CAPTURE] to start capturing continuously, or press [CAPTURE] again to exit.
- To change the quality of captured images, please refer to [7.11.2 Setting the quality of captured images.](#)
- To change the settings of captured images, please refer to [7.11.3 Setting continuous capture.](#)

7.11.2 Setting the quality of captured images

1. Press [MENU] on the **remote control** or **control panel** to enter the setting menu.
2. Press [▶] or [◀] to the [Storage] menu.
3. Press [▼] to find [Image Quality].
4. Press [▶] or [◀] to select among [High/Medium/Low].
5. Press [MENU] to exit.

7.11.3 Setting continuous capture

1. Press [MENU] on the **remote control** or **control panel** to enter the setting menu.
2. Press [▶] or [◀] to the [Setting] menu.
3. Press [▼] to find [Capture Action].
4. Press [▶] or [◀] to select [continuous].
5. Press [▼] to the [Capture Mode].
6. Press [▶] or [◀] to select [Photo].
7. Press [▼] to find [Capture Time]; Press [▶] or [◀] to select capture time.
8. Press [▼] to find [Capture Interval]; Press [▶] or [◀] to select interval time.
9. Press [MENU] to exit.

7.12 I would like to record videos

7.12.1 Recording motion images

<Note> You may not be able to capture or record images when [Capture Action] mode is set to [Disable].

Remote control:

1. Press [RECORD] to record videos.
2. Record sounds with the built-in microphone of the control panel.
3. Press [RECORD] again to stop recording.

Control panel:

1. Press [MENU] to enter the setting menu.
2. Press [▶] or [◀] to the [Setting] menu.
3. Press [▼] to the [Capture Mode].
4. Press [▶] or [◀] to select [Video].
5. Press [MENU] to exit.
6. Press [CAPTURE] to record videos.
7. Press [CAPTURE] again to stop recording.

7.12.2 Setting the image quality

1. Press [MENU] on the **remote control** or **control panel** to enter the setting menu.
2. Press [▶] or [◀] to the [Storage] menu.
3. Press [▼] to find [Image Quality].
4. Press [▶] or [◀] to select among [High/Medium/Low].
5. Press [MENU] to exit.

7.12.3 Playing videos

- For playing videos, please refer to [7.13 I would like to view captured/recorded images.](#)

7.13 I would like to view captured/recorded images

1. Press [PLAYBACK] on the **remote control** to show the thumbnails of all stored files.
2. Press [▲] or [▼] or [◀] or [▶] to select the thumbnail you want you browse.
3. Press [ENTER] for the full-screen display of the image.
4. Press [▶] or [◀] to select different video and audio files.
5. Press [▲] or [▼] to adjust the volume of the video.

6. Press [MENU] to exit.

<Note> A better playback performance will be achieved when an external speaker is connected to AUDIO OUT.

7.14 I would like to delete the captured/recorded images

1. Use the **remote control** and press [PLAYBACK].
2. Press [▲] or [▼] or [◀] or [▶] to select the file you want to delete.
3. Pressing [DELETE] will open a [Delete File] window.
4. Press [▶] or [◀] to select [Yes] (The default value is No).
5. Press [ENTER] to delete the selected file.
6. Press [MENU] to exit.

7.15 I would like to automatically delete the stored images whenever it is turned off (Auto Erase)

1. Press [MENU] on the **remote control** or **control panel** to enter the setting menu.
2. Press [▶] or [◀] to the [Storage] menu.
3. Press [▲] or [▼] to [Auto Erase].
4. Press [▶] or [◀] to select [On].
5. Press [MENU] to exit.

<Remark> It will automatically delete all captured photos when it is turned off.

7.16 I would like to use the MASK and Spotlight function

7.16.1 I would like to use the MASK or Spotlight mode

Use **Remote control**:

1. Press [MASK] to enter the Mask mode, and press [▲], [▼], [◀], or [▶] to move the mask position.
2. Press [MASK] again to enter the Spotlight mode, and press [▲], [▼], [◀], or [▶] to move the zone position.
3. Press [MASK] again to exit and return to the live image screen.

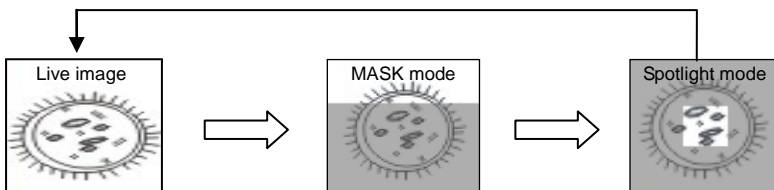

7.16.2 I would like to set the size of Mask/Spotlight function

In Mask/Spotlight mode, use the **remote control**:

1. Press [MENU] to enter the image OSD menu.
2. Press [▲] or [▼] to select the item to be modified [Transparency/Step/V Size/H Size]. (For details, please refer to [6.2 Setting Menu.](#))
3. Press [◀] or [▶] to perform the modification.
4. Press [MENU] to exit the image OSD menu and return to the Mask mode.

7.17 I would like to enlarge a part of the image (PAN)

Use **Remote control**:

1. Press [PAN] to enter the Partial Enlarged mode.
2. Press [▲], [▼], [◀], or [▶] to move and view the partial enlarged images.
3. Press [PAN] to exit the partial enlarged mode.

7.18 I would like to play the slides (Slide Show)

7.18.1 Setting delay time

1. Press [MENU] on the **remote control** or **control panel** to enter the setting menu.
2. Press [▶] or [◀] to the [Storage] menu.
3. Press [▼] to find [Delay].
4. Press [▶] or [◀]] to select image switch mode between [0.5 Sec/1 Sec/3 Sec/5 Sec/10 Sec/Manual].
5. Press [MENU] to exit.

7.18.2 Activating/Stopping the slide show

<Note> Upper Limit: The maximum size of single photo is 7 MB.

Remote control:

1. Press [SLIDE SHOW] to start playing.
2. Press [ENTER] to pause playing.
3. Press [ENTER] again to continue playing.
4. Press [SLIDE SHOW] again to stop playing.

Control panel:

1. Press [MENU] to enter the setting menu.
2. Press [▶] or [◀] to the [Storage] menu.
3. Press [▼] to find [Slide Show].
4. Press [ENTER] to play.
5. Press [ENTER] to pause playing.
6. Press [ENTER] again to continue playing.
7. To stop playing, repeat Steps 1 and 4.

7.19 I would like to view the X-ray film

1. Place an X-ray film to be displayed under the camera.
2. Press [Lamp] button on the control panel to switch on the **Backlight** (in the sequence of arm lamp/backlight/OFF)
3. Press [AUTO TUNE] button to optimize the image.

7.20 I would like to compare images (compare live images with stored images (PIP))

This function will compare and contrast a live image with a stored image.

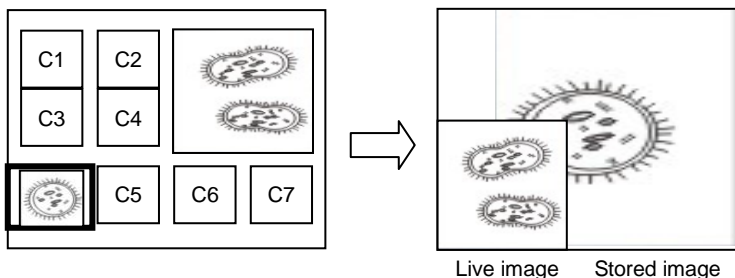

Remote control:

1. Press [PIP] to enter the photo selection screen.
2. Press [▲], [▼], [◀], or [▶] to select the file to be compared.
3. Press [ENTER] to activate image comparison.
4. Press [▲], [▼], [◀], or [▶] to move the live image.
5. Press [PLAYBACK] to return to image thumbnails and compare it with other images.
6. Press [MENU] to exit.

7.21 I would like to reduce the image noise (Projector Type)

1. This function enables Document Camera to automatically clear image noise. The noise is especially obvious when Document Camera is connected to a DLP projector. You can set the DLP projector to improve the image quality.
2. If there is special noise when VGA out is connected, please set DLP option to improve the image quality.

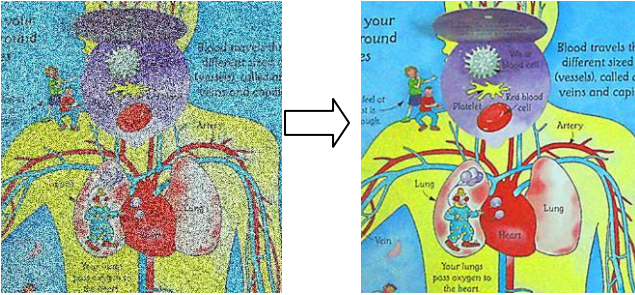

- 2.1. Press [MENU] on the **remote control** or **control panel** to enter the setting menu.
- 2.2. Press [▶] or [◀] to the [Setting] menu.
- 2.3. Press [▼] to enter [Projector Type].
- 2.4. Press [▶] or [◀] to select [**LCD/DLP**].
- 2.5. Press [MENU] to exit.

7.22 I would like to set the time for PS760

7.22.1 If you use the remote control or the control panel

1. Press [MENU] on the **remote control** or **control panel** to enter the setting menu. (Refer to [6.2.4 Date & Time Setting Menu of 6.2 Setting Menu.](#))
2. Press [▶] or [◀] to select [Advanced] menu.
3. Press [▼] to the [Date & Time].
4. Press [ENTER] to open the date & time OSD menu.
5. Press [▲] or [▼] to the item to be set [Year/Month/Day/Hour/Minute].
6. Press [▲] or [▼] to modify the value.
7. Press [▶] or [◀] to move to the next item.
8. Press [MENU] to exit the item you have set.
9. Repeat steps 5 through 9 until you have completed the modifications.
10. Press [MENU] to exit OSD menu.

7.22.2 To use web remote control

<Remark> For more information about the website login page, please refer to [7.26.1 I would like to view the live image or use the control keys.](#)

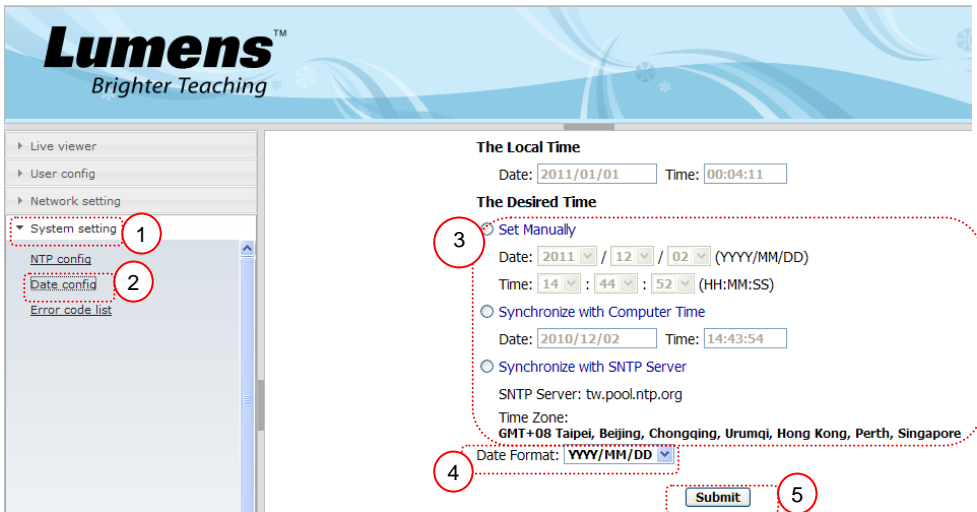

1. Click [System setting].
2. Click [Date config].
3. Set the date and time.

<Remark> **Set Manually:** Set the date and time manually.

Synchronize with Computer Time: Synchronize time with the PC.

Synchronize with SNTP Server: Synchronize time with SNTP server.

4. Select the date format.
5. Click [Submit] to conform and submit.

7.23 I would like to lock/unlock keys

Press and hold [AUTO TUNE] on the control panel for 2 seconds to lock keys. To unlock keys, repeat the above procedure.

<Remark> **When the keys are locked, the LED indicator of [ENTER] on the remote control will light up red.**

<Remark> This function applies to the keys of the control panel only. The remote control can still be used. If you use the remote control to turn off the power, the keys will be unlocked automatically after reboot.

7.24 I would like to resume the factory default settings (Factory Reset)

7.24.1 Using OSD menu

1. Press [MENU] on the **remote control** or **control panel** to enter the setting menu.
2. Press [▶] or [◀] to select [Advanced] menu.
3. Press [▼] to select [Factory Reset].
4. Press [▶] or [◀] to select [Yes].
5. Press [ENTER] to activate.

7.24.2 Use Compound Key

1. Use the **control panel**, and press [ENTER + AUTO TUNE] simultaneously to restore the initial value.

7.25 I would like to use a USB disk

1. Insert the USB disk and a [Copy To USB Disk] dialog box will appear, and you are asked whether to copy files from PS760 to the USB disk.
 - Press [▶] or [◀] on the **remote control** or **control panel** to select.



7.26 Computer-related functions

Ensure that the USB cable is connected and the software and drivers are installed before using the computer-related functions. Refer to [Chapter 4 Installation and Connections 4.11 Installing application software](#) in this user manual.

7.26.1 I would like to insert a photo in MS-Paint

<Remark> Support **Windows XP Operation System only.**

1. Click [File/From Scanner or Camera] in MS-Paint as shown in the bottom left figure.

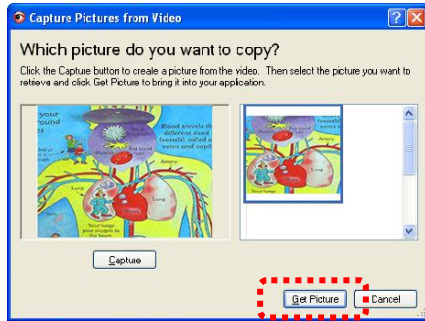
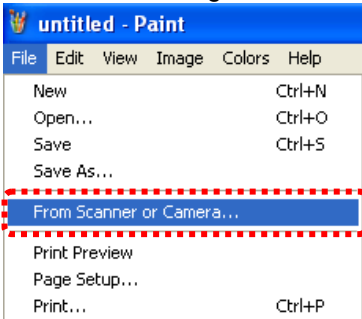

2. Click [Get Picture] will capture the photos of live images and insert the files in use shown as top right figure.

7.26.2 I would like to insert a photo in MS-Word

<Remark> Support **Windows XP Operation System only.**

1. Click [Insert/Image/From Scanner or Camera] in **MS-Word**.

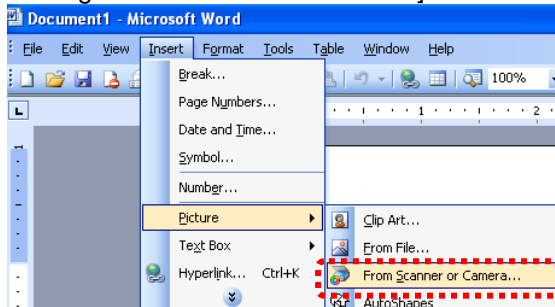

2. Select [USB Video Device] and click [Custom Insert].

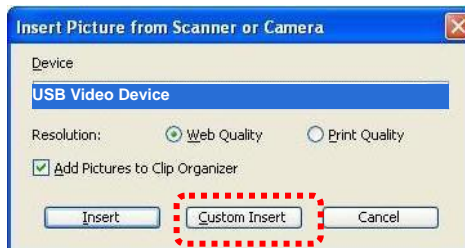

3. Click [Get Picture]. It will capture the photo of live image.

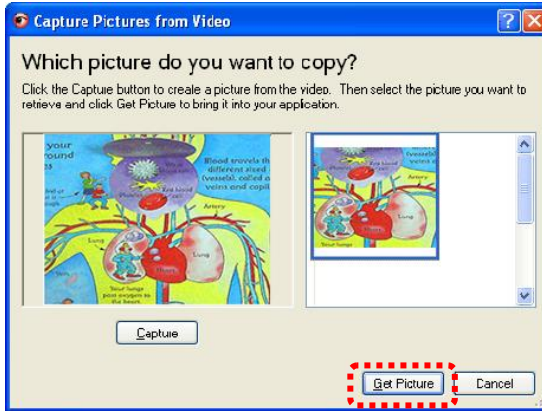

7.26.3 I would like to change the setting of the PS760 and then capture a photo in MS-Word

<Remark> For **Windows Office 2003** or later versions, please use the function with **OneNote**.

1. Click [Insert/Image/From Scanner or Camera] in **MS-Word**.

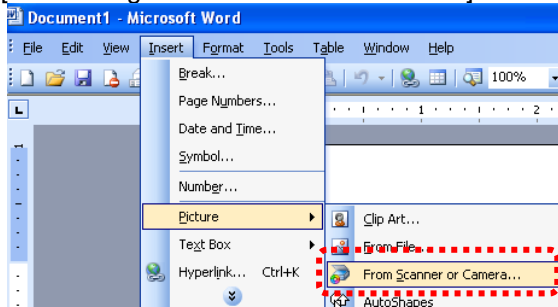

2. Select [Lumens Document Camera Twain] and click [Custom Insert].

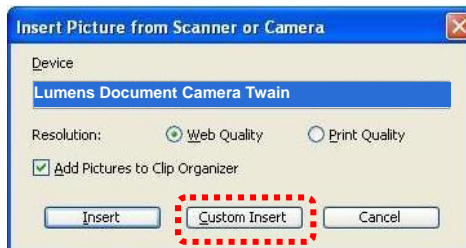

3. A window showing a live image (see below) will be displayed.

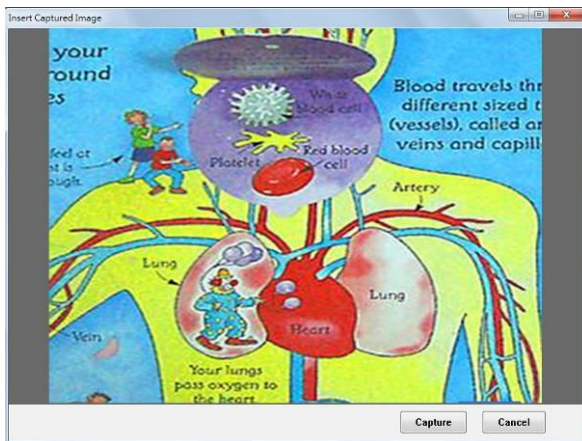

4. Press [Capture] to capture images in **MS-Word**.

5. Press [Cancel] to exit.

7.26.4 I would like to set the PS760 as a PC Camera

<Remark> For Windows XP, please set by system name (USB video device)

Open [My Computer] and click [Lumens Document] to open a live image.

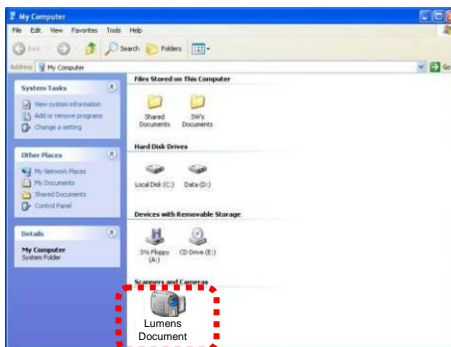

7.26.5 I would like to connect an Interactive Whiteboard

To connect an Interactive Whiteboard, go to Lumens website to download the reference guide for a specific brand.

(<http://www.lumens.com.tw/goto.htm>).

7.27 I would like to use the network remote control function

- Network has a longer distance for controlling than USB and RS232 interface do. Each function of PS760 could be controlled and used by the browser (IE) on the computer for users.

7.27.1 I would like to view the live images or use the control keys

7.27.1.1 Login to the PS760 network control page

1. Open the web browser (Internet Explorer) and enter the **IP address** in the address bar

<Remark> To check IP address, please refer to [7.26.1.2 I would like to check the network settings](#).

2. Enter the account [admin].
3. Enter the password (default password is [9999]), and then click [OK].



7.27.1.2 I would like to check the network settings

DHCP is enabled by default. Please follow the steps below to check the IP address.

1. Press [MENU] on the **remote control** or **control panel** to enter the setting menu.

2. Press [▶] or [◀] to the [Advanced] menu.
3. Press [▲] or [▼] to the [Ethernet].
4. Press [ENTER] to open the Ethernet OSD menu.
5. Press [MENU] to exit OSD menu.

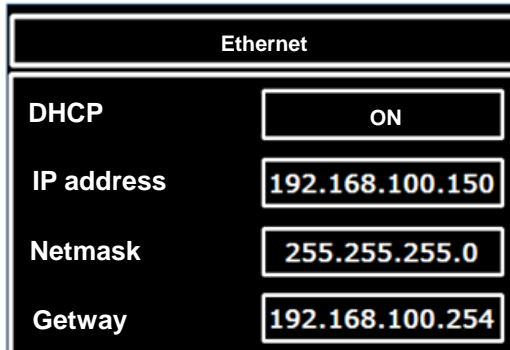

7.27.1.3 View the live image

A. Use IE browser



1. View the live image.
2. The control method of control keys is the same as that of the remote control. The button will be gray and disabled for users whose permission is view-only.
3. Change the size of live image.

<Remark> For more information about user permissions, please refer to [7.26.2 I would like to add or modify the user account.](#)

B. Using VLC

<Remark> It is recommended that you download the VLC software and view with it when the number of users is more than four.

Besides, all users must be in the same domain.

VLC is only provided for viewing, no control keys are available.

7.27.2 I would like to add or modify the user account

<Remark> Reference for User Permissions

User Type	Admin	Operator	Viewer
Applications	IE	IE	IE or VLC
Account management	Y	N	N
Operating functions	Y	Y	N
View images	Y	Y	Y
Limitation on the number of accounts	1	3	5

7.27.2.1 I would like to add the user account

1. Click [User config].
2. Click [Account management].
3. Enter the username in the [User Name].
4. Enter the password in the [Password].
5. Enter the password in the [Confirm] again.
6. Set the permissions in the [Authority].
7. Click [Submit] to conform and submit.

7.27.2.2 I would like to delete the user account

1. Click the username in the [User List].
2. Click [Delete User] to delete the user.

7.27.2.3 I would like to modify the user password and permissions

1. Click the username in the [User List].
2. Enter the old password in the [Old Password].
3. Enter the password in the [Password].
4. Enter the password in the [Confirm] again.
5. Set the permissions in the [Authority].
6. Click [Submit] to conform and submit.

Chapter 8 Connecting to Microscope

- 1 Mount the **microscope adapter** (Optional) onto the microscope.
<Note> Please choose an appropriate microscope adapter. Microscope adapter accessories are applicable to eyepieces of \varnothing 28 mm, \varnothing 31 mm, \varnothing 33 mm, and \varnothing 34 mm.
- 2 The lens of PS760 connects with the **microscope adapter**

If the eyepiece is \varnothing 33 mm or \varnothing 34 mm, only **one Lumens microscope adapter** is needed.

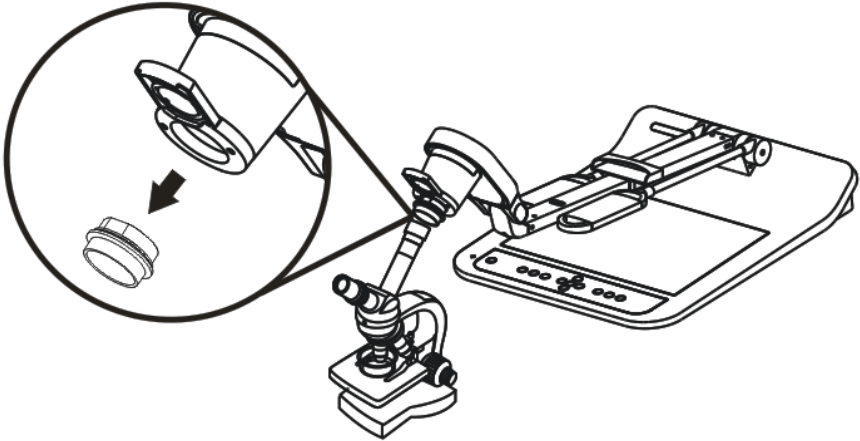

If the eyepiece is \varnothing 28 mm or \varnothing 31 mm, you need **two microscope adapters**. (1. The **Lumens microscope adapter**. 2. The **microscope adapter suitable** for the eyepiece size \varnothing 28 mm or \varnothing 31 mm).

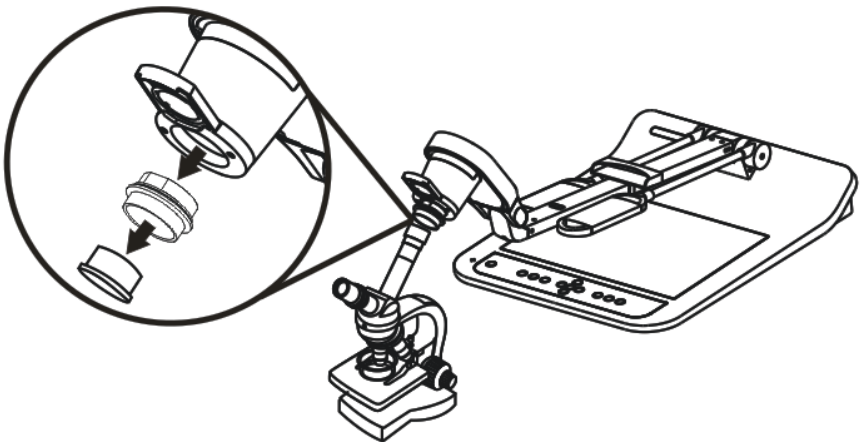

3 Select the **[Microscope]** mode

3.1. If you use the **remote control** or the **control panel**

- 3.1.1. Press [MENU] to enter the setting menu.
- 3.1.2. Press [▶] or [◀] to the [Display].
- 3.1.3. Press [▼] to select [Mode].
- 3.1.4. Press [▶] or [◀] to the [Microscope].

4 If the image is not clear

- 4.1. Please adjust the focus of microscope.
- 4.2. Please press the **remote control** or the **control panel** [AUTO TUNE] button to activate the auto focus.

5 Digital Zoom

5.1. If you use the **remote control** or the **control panel**

- 5.1.1. Press [MENU] to enter the setting menu.
- 5.1.2. Press [▶] or [◀] to the [Display].
- 5.1.3. Press [▼] to select [Digital Zoom].
- 5.1.4. Press [▶] or [◀] to the [On].
- 5.1.5. Press [ZOOM +] / [ZOOM -].

<Note> Please reset to normal mode after using the microscope, otherwise, you are unable to use zoom in/out function.

1. Press [MENU] on the **remote control** or **control panel** to enter the setting menu.
2. Press [▶] or [◀] to the [Display].
3. Press [▼] to select [Mode].
4. Press [▶] or [◀] to the [Normal].

Chapter 9 DIP Switch

<Note> You should unplug and reconnect the power cord, and then restart the PS760 for all DIP Switch Settings to take effect.

9.1 Connecting to a projector or monitor

9.1.1 XGA 60Hz output (default values)

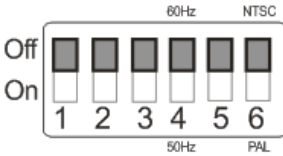

XGA 50Hz output



9.1.2 SXGA 60Hz output

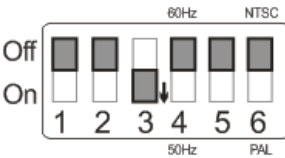

SXGA 50Hz output

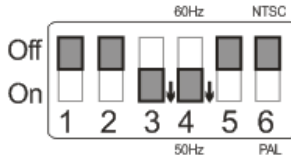

9.1.3 WXGA 60Hz output

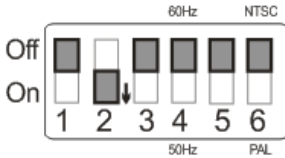

WXGA 50Hz output

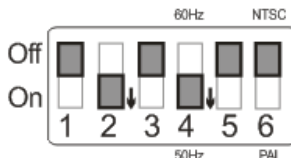

9.1.4 UXGA 60Hz output

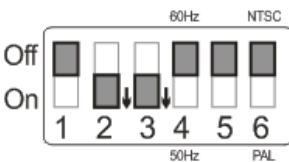

UXGA 50Hz output

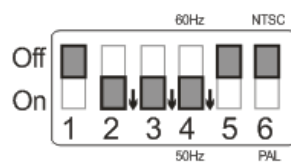

9.1.5 1080P 60 Hz output

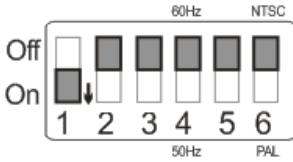

1080P 50 Hz output

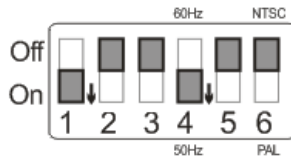

9.2 Connecting to a TV/DVD

9.2.1 NTSC: USA, Taiwan, Panama, Philippines, Canada, Chile, Korea, and Mexico.

60Hz



50Hz

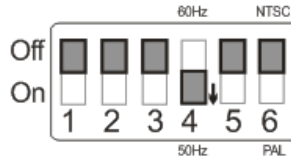

9.2.2 PAL: Countries/regions not listed above.

60Hz

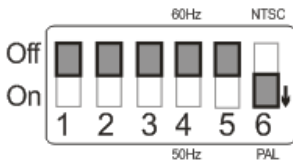

50Hz

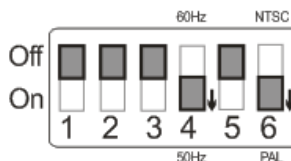

Chapter 10 Packing the Machine

1. Put the remote control back to the holder.
2. Fold back the camera head to align with the arm.
3. Turn the two lamp arms and the arm of camera head down and adjust them to be parallel with the platform.
4. Put the lens cap on the camera head.
5. Finally, fold the machine as in the following figure.

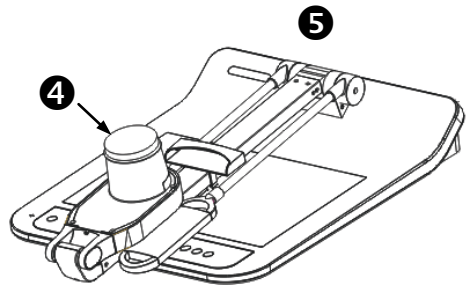
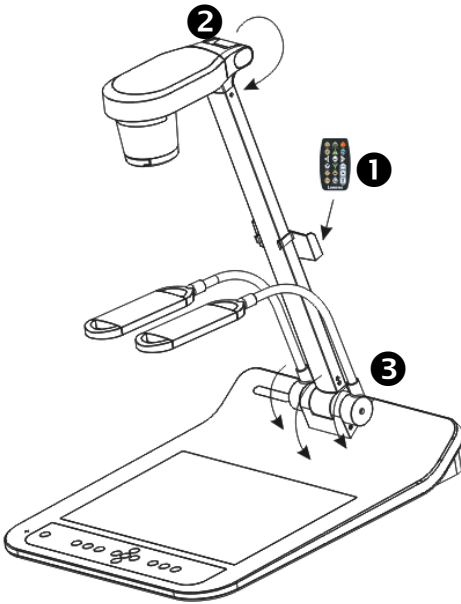

Chapter 11 Troubleshooting

This chapter describes problems you may encounter while using PS760. If you have questions, please refer to related chapters and follow all the suggested solutions. If the problem still occurred, please contact our distributors or service center.

No.	Problems	Solutions
1	Boot without power signal	Make sure you have plugged in the power cord.
2	No image output from the PS760	<ol style="list-style-type: none"> 1. Check the power 2. Check all cable connections. Refer to Chapter 4 Installation and Connections in this manual. 3. Check the , refer to PS750 User Manual Chapter 7 Descriptions of major functions 7.2 I would like to switch image sources. 4. Check the settings for the source of the projector. For the appropriate input selection of the projector, refer to the projectors user manual. 5. Check if DIP Switch is properly set. Refer to Chapter 9 DIP Switch Settings for related settings.
3	Unable to focus	Probably the document is too close. Press [ZOOM-] on the remote control or control panel . Or pull away the distance between document and lens, then press [AUTO TUNE].
4	The image is incomplete	Check the Auto Image setting of your projector. Please refer to the user manual of the projector or check for the DIP SWITCH settings.
5	Forget the password for turning on	Please contact your distributor or the service center.
6	Lumens Document Camera, Lumens™ and other applications cannot be used simultaneously	Lumens Document Camera, Lumens™ and other applications cannot be executed simultaneously. Only one application can be executed at a time. Please close the currently running applications and then execute the application to be used.
7	When the unit is turned on, the auxiliary floodlight do not light	Please make sure the arm lamp is set to [OFF]. For the switch-on or -off of arm lamp, refer to PS750 User Manual Chapter 7 Descriptions of major functions 7.8 I would like to turn on/off the lamp .
8	PS760 fails to store images or react	<ol style="list-style-type: none"> 1. Check to see if the stored data have reached the maximum size of the USB device (priority) or internal memory. 2. Please make sure if the Capture function is set to Continuous mode or the time for capture is set to be

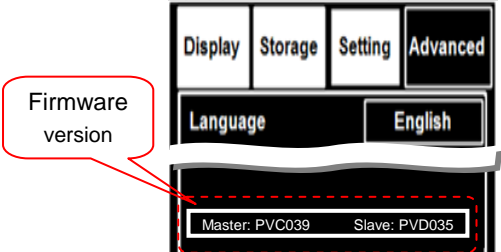
		long. For the related setting, refer to 7.11 I would like to capture images of Chapter 7 Descriptions of major functions.
9	The images outputted from PS760 are too bright, dark or vague	Press [AUTO TUNE] to automatically adjust to the optimal brightness and focal length.
10	Unable to record images	<ol style="list-style-type: none"> 1. Check to see if the stored data have reached the maximum size of the USB disk (priority) or internal memory. 2. Please confirm the rotation angle. You may not able to record when the image is rotated by 90°/270°.
11	The operating steps in the manual are not applicable to the machine	<p>The operating steps in the manual may be not applicable to the machine due to improvement in functions. Check to see if the Firmware version of your machine is up-to-date.</p> <ol style="list-style-type: none"> 1 Please go to Lumens official website to check whether the latest version is available for update. http://www.lumens.com.tw 2 The steps to check the FW version are as below: <ol style="list-style-type: none"> 2.1 Press [MENU] on the remote control or control panel to enter the setting menu. 2.2 Press [▶] or [◀] to select [Advanced] menu.  <p>If you are not sure whether it is the latest version, please consult your dealer for advice. http://www.lumens.com.tw/tw/support-cf.asp</p>
12	Unable to login to the network control page	<p>If DHCP is enabled, the IP address may not be updated. Please follow the steps below:</p> <ol style="list-style-type: none"> 1 Press [MENU] on the remote control or control panel to enter the setting menu. 2 Press [▶] or [◀] to the [Advance] menu. 3 Press [▲] or [▼] to the [Ethernet]. 4 Press [ENTER] to open the Ethernet OSD menu. 5 Press [▼] to find [DHCP]. 6 Press [ENTER] to modify it. 7 Press [▲] or [▼] to select [On]. 8 Press [MENU] to exit the Ethernet OSD menu. 9 Repeat steps 3 ~ 4 and check IP address.

13	The images outputted are not clear, and the moire appears.	Please refer to the manual (Attachment 1), confirm the voltage frequency and reset it according to Chapter 9 DIP Switch Settings
----	---	--

Attachment 1

World voltage & frequency

Region/Country		Frequency	Region/Country		Frequency	Region/Country		Frequency
Chinese	English		Chinese	English		Chinese	English	
阿富汗	Afghanistan	50	大陸	China	50	關島	Guam	60
阿爾及利亞	Algeria	50	哥倫比亞	Colombia	60	石榴島	Grenada	50
安哥拉	Angola	50	剛果	Congo	50	瓜地馬拉	Guatemala	60
安地瓜	Antigua	50	哥斯大黎加	Costa Rica	60	幾內亞	Guinea	50
阿根廷	Argentina	50	古巴	Cuba	60	蓋亞納	Gayana	50
澳洲	Australia	50	塞浦路斯	Cyprus	50	海地	Haiti	60
奧地利	Austria	50	捷克	Czechoslovakia	50	夏威夷	Hawaii	60
亞述爾	Azores	50	達荷美	Dahomey	50	宏都拉斯	Honduras	60
巴哈馬	Bahamas	60	丹麥	Denmark	50	香港	Hong Kong	50
巴林	Bahrain	60	多明尼加	Dominican	60	匈牙利	Hungary	50
孟加拉	Bangladesh	50	杜拜	Dubai	50	冰島	Ice land	50
巴貝多	Babados	50	厄瓜多爾	Ecuador	60	印度	India	50
比利時	Belgium	50	埃及	Egypt	50	印尼	Indonesin	50
百慕達	Bermuda	60	薩爾瓦多	El Salvador	60	伊朗	Iran	50
玻利維亞	Bolivia	50	赤道幾內亞	Equatorial Guinea	50	伊拉克	Iraq	50
波札那	Botswana	50	衣索匹亞	Ethiopia	50	愛爾蘭	Ireland	50
巴西	Brazil	50 60	法羅群島	Faeroe Island	50	曼島	Isle of Man	50
保加利亞	Bulgaria	50	斐濟	Fiji	50	以色列	Israel	50
緬甸	Burma	50	芬蘭	Finland	50	義大利	Italy	50
蒲隆地	Burundi	50	法國	France	50	象牙海岸	Ivory Coast	50
高棉	Cambodia	50	蓋亞那	French Guiana	50	牙買加	Jamaica	50
喀麥隆	Cameroon	50	加彭	Gabon	50	日本	Japan	50 60
加拿大	Canada	60	甘比亞	Gambia	50	約旦	Jordan	50
康那利群島	Canary Island	50	德國	Germany	50	肯亞	Kenya	50
中非共和國	Central Africa Rep.	50	迦納	Ghana	50	韓國	Korea	60
錫蘭	Ceylon	50	直布羅陀	Gibraltar	50	科威特	Kuwait	50
查德	Chad	50	大不列顛	Great Britain	50	黎巴嫩	Lebanon	50
海峽群島	Channel Island	50	希臘	Greece	50	賴索托	Lesotho	50

Region/Country		Frequency	Region/Country		Frequency	Region/Country		Frequency
Chinese	English		Chinese	English		Chinese	English	
智利	Chile	50	格陸蘭	Greenland	50	賴比瑞亞	Liberia	60
利比亞	Libya	50	阿曼	Oman	50	敘利亞	Syria	50
盧森堡	Luxembourg	50	巴基斯坦	Pakistan	50	大溪地	Tahiti	60
澳門	Macao	50	巴拿馬	Panama	60	中華民國	R.O.C. Taiwan	60
馬得拉群島	Madeiral	50	巴拉圭	Paraguay	50	坦尚尼亞	Tanzania	50
馬約卡島	Majorca Island	50	秘魯	Peru	60	泰國	Thailand	50
馬拉加西	Malagasy	50	菲律賓	Philippines	60	多哥共和國	Togo Rep.of	50
馬拉威	Malawi	50	波蘭	Poland	50	東加	Tonga	50
馬來西亞	Malaysia	50	葡萄牙	Portugal	"	千里達	Trinidad	60
馬利	Mali Rep.	50	波多黎各	Puerto Rico	60	他巴哥	Tobago	60
馬爾他	Malta	50	科托	Qatar	50	突尼西亞	Tunisia	50
馬丁尼克島	Martinique	50	羅德西亞	Rhodesia	50	土耳其	Turkey	50
茅里塔尼亞	Mauritania	50	羅馬尼亞	Romania	50	烏干達	Uganda	50
模里西斯	Mauritius	50	盧安達	Rwanda	50	美國	USA.	60
墨西哥	Mexico	60	沙烏地阿拉伯	Saudi Arabia	50 60	蘇聯	USSR	50
摩那哥	Monaco	50	蘇格蘭	Scotland	50	英國	United Kingdom	50
蒙特塞納島	Montserrat	60	塞內加爾	Senegal	50	上伏塔	Upper Volta	50
摩洛哥	Morocco	50	獅子山	Sierra Leone	50	烏拉圭	Uruguay	50
莫桑鼻克	Mozambique	50	新加坡	Singapore	50	委內瑞拉	Venezuela	60
尼泊爾	Nepal	50	索馬利亞	Somalia	50	越南	Viet-Nam	50
荷蘭	Netherlands	50	南非共和國	South Africa Rep.	50	維爾京群島	Virgin Island	60
新蘇格蘭	New Caledonia	50	西班牙	Spain	50	西薩摩亞	Western Samoa	50
紐西蘭	New Zealand	50	斯里蘭卡	Sri Lanka	50	葉門亞丁	Yemen(Aden)	50
尼加拉瓜	Nicaragua	60	蘇丹	Sudan	50	葉門阿拉伯	Yemen(Arab)	50
尼日	Niger	50	蘇利南	Surinam	60	南斯拉夫	Yugoslavia	50
奈及利亞	Nigeria	50	史瓦濟蘭	Swaziland	50	薩伊共和國	Zaire Rep. of	50
挪威	Norway	50	瑞典	Sweden	50	尚比亞	Zambia	50
琉球	Okinawa	60	瑞士	Switzerland	50			