

PZ 640T GH NG and PZ 750R GH NG

Operating, Care and Installation Instructions

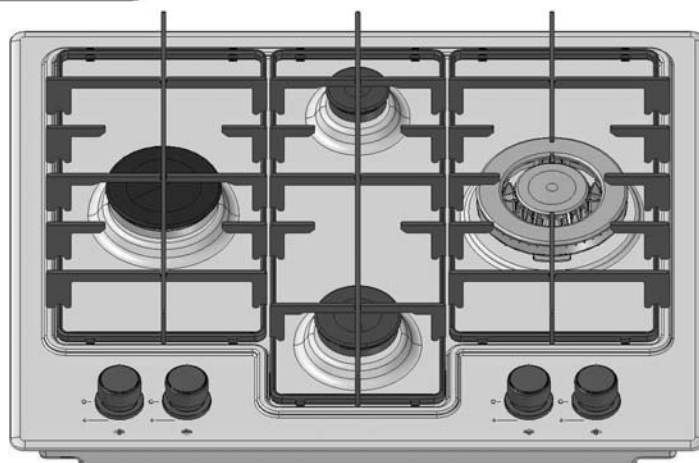
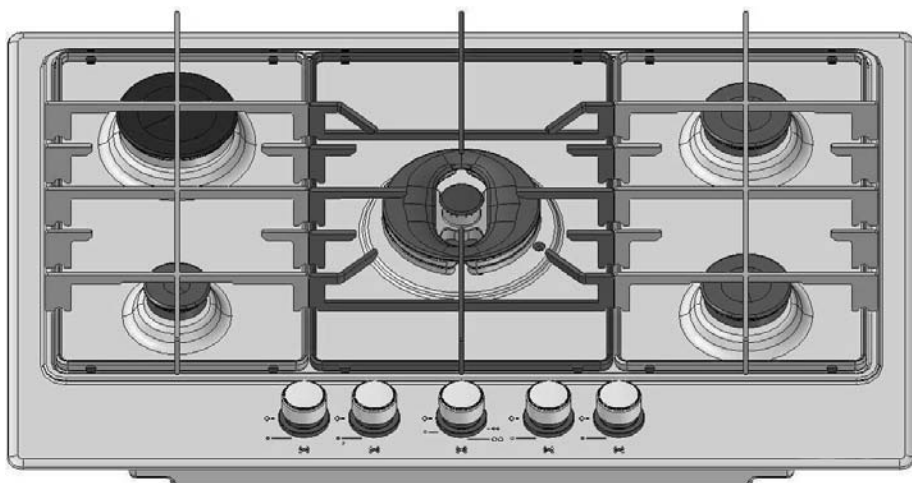

Contents

Safety Warnings	2
Using Your Cooker	3
Installation	4-5
Service Details	6
Troubleshooting	7
Care And Maintenance	8



Installer - Ensure these instructions remain with the consumer.
This cooktop has been certified for use by SAI-Global

Safety Warnings

- ❑ This appliance has been designed and manufactured in compliance with Australian and international safety standards. The following warnings are provided for safety reasons and must be read carefully.
- ❑ DO NOT SPRAY AEROSOLS IN THE VICINITY OF THIS APPLIANCE WHILE IT IS IN OPERATION.
- ❑ DO NOT MODIFY THIS APPLIANCE.
- ❑ DO NOT USE OR STORE FLAMMABLE MATERIALS NEAR THIS APPLIANCE.
- ❑ This appliance is not suitable for marine craft, caravans or recreational vehicles
- ❑ This appliance is not intended to be used by young children, the elderly or infirm without supervision.
- ❑ Young children should be supervised at all times when near this appliance.
- ❑ If the appliance fails to operate correctly, contact place of purchase or their appointed agent for advice and service.
- ❑ Do not touch hot surfaces. Allow hob to cool before wiping spillage.
- ❑ There are no user serviceable parts within this appliance. For any service, contact the place of purchase or the nominated service agent. Do not attempt repairs yourself.
- ❑ The appliance was designed for domestic use inside the home and is not intended for commercial or industrial use.
- ❑ The appliance must not be installed outdoors, even in covered areas. It is extremely dangerous to leave the appliance exposed to weather.
- ❑ Always make sure the knobs are in the OFF position when the appliance is not in use.
- ❑ Always make sure that pan handles are turned towards the centre of the hob in order to avoid accidental burns.
- ❑ Gas appliances require a regular air supply to maintain efficient operation. Always ensure that the kitchen is adequately ventilated whilst the appliance is in use.
- ❑ Never leave cooking food unattended. Do not allow the liquid to boil dry
- ❑ Do not use asbestos mats or heat diffusers, as these trap the heat and can cause damage to the cooktop from overheating.
- ❑ Don't wear loose clothing while cooking, as garments may catch utensil handles or catch fire.
- ❑ Use dry utensil holders. Wet pot holders can build up steam. Do not use towels or other large pieces of cloth to pick up cooking utensils, as these may touch the heating element and catch fire.
- ❑ Do not allow pot handles to overhang other burners that are in use, as this will cause scorching of the handle, and potential handling burns.

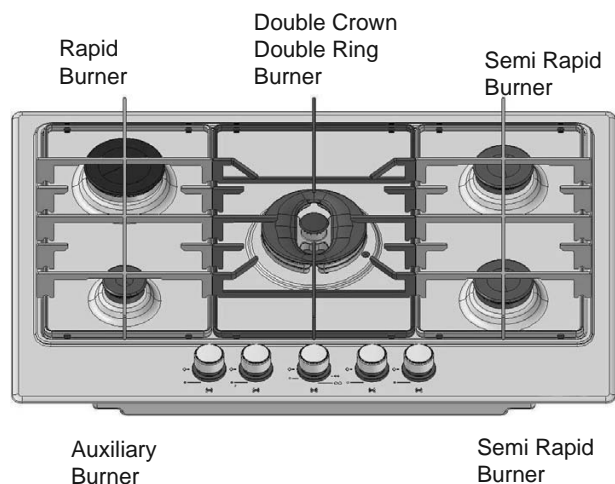
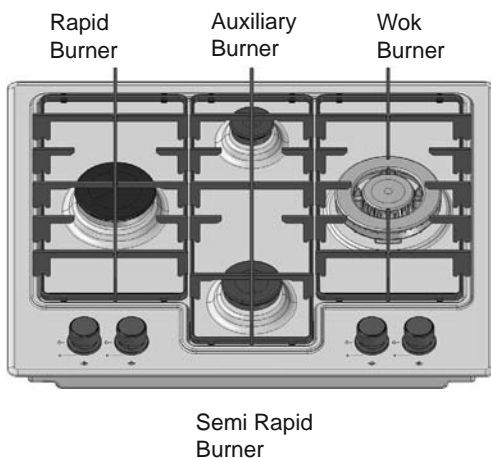

Using Your Cooker

Controlling the burners

Each control knob is marked to indicate which burner it controls. Each control knob also has markings to indicate the three main settings:

- OFF
- 🔥 High
- 🔥 Low

Lighting the burners

Your Arisit hobs are equipped with a safety probe that prevents the gas from flowing unless there is a flame.

To ignite a burner, press and turn the control knob counter-clockwise until the knob points to High. Keep pressing the knob inwards until the probe heats up. Release the knob.

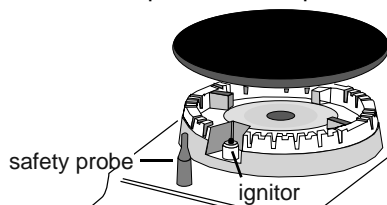

Check that the gas has been lit. If the burner fails to ignite try again. If the burner fails to ignite after 3 attempts, wait a few minutes for the gas to disperse before making any further attempts.

If the burner still fails to ignite, a match or lighting device can be used, but care must be taken. If the problem persists, contact place of purchase or their appointed agent for service.

Controlling the flame height

Any flame height can be achieved between High and Low by rotating the control knob between the two positions:

Avoid operating the burner with the control knob set between Off and High.

If a flame is accidentally extinguished, turn off the control knob and wait for at least 1 minute before relighting.

Double Crown Double Ring Burner (PZ750 only)

Double ring burners have two independent gas rings controlled by the one control knob. Turning the knob anticlockwise from the Off position controls the smaller inner ring only.

To switch on the outer ring, keep turning the knob anticlockwise past the 6 O'Clock position. The outer ring will ignite

as well, and both rings will be on High 🔥🔥.. Continue to rotate the knob until both rings are operating on Low 🔥🔥..

To turn off the burner

To switch off the burner, turn the knob in a clockwise direction until it reaches the Off position.

Lighting the burners for the first time

If the appliance is being used for the first time, or if it has not been used for a long period of time, it may be necessary to purge the gas lines of excess air before you can successfully light the burners.

To do this, turn each burner to high for 10-15 seconds and press the ignition button several times. If the burner does not light, repeat this procedure twice more. Wait 1-2 minutes for any gas build up to disperse before allowing any further gas flow.

Cookware

Use appropriate cookware for each burner

- Always use a vessel for cooking that is appropriate in size for the size of burner. Ensure the flames do not extend beyond the bottom of the pot.
- Never use pots that are too small or too large. For wok cooking it is recommended that a domestic size wok, no larger than 400 mm in diameter be used.
- Always use cookware with a flat base. Do not use pans which are unstable or which have a warped or damaged base.
- Ensure the pot sits securely on the trivet and is centred above the burner.
- Small pots can be used on the inner ring of the double crown double ring burner.

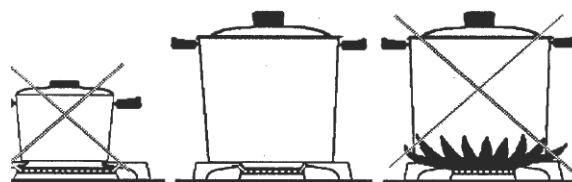

Installation

WARNING: Before installation, check that the gas type (natural gas or LPG/Propane) of the cooker is suitable for the gas type available to the installation. It is extremely dangerous to use the wrong gas type with any appliance, as fire or serious injury can result.

These instructions have been prepared for use by authorised persons. This unit must only be installed by an authorised person.

This appliance must not be installed in marine craft or recreational vehicles.

Compliance with standards

This cooktop must be installed in accordance with the requirements of local gas and electrical authorities, as well as the latest published versions of the following standards:

- AS/NZS 5601 Gas Installation code
- SAA Wiring Rules

Dimensions of cutout

The following diagram indicates the dimensions of the required cutout.

In placing the cooktop, suitable insulation between the cooktop underside and the top of the bench should be used.

Wherever possible, the cooktop should be secured to the benchtop using clamps.

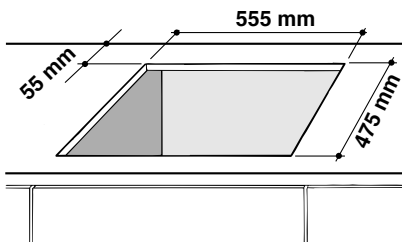

INSTALLER: Please also ensure that the duplicate data label supplied, be affixed in a suitable easily accessible location such as an adjacent cupboard or drawer, for future reference.

Dimensions (mm)	PZ640	PZ750
length (side to side)	600	750
width (front to back)	510	510
depth	44	44

Fitting the cooktop into cabinetry

The following minimum clearances to combustible materials must be observed:

- Minimum clearance from edge of burner to side wall must be 200 mm.
- Minimum clearance from edge of burner to rear wall must be 200 mm.
- Minimum clearance from top of highest burner to cupboard above hob burners must be 600 mm.

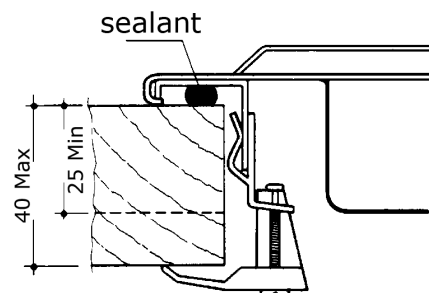
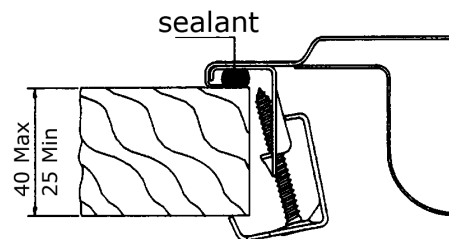

Fixing to the housing unit

Proceed with fixing to the housing unit as follows (see figure above).

- Mount the hooks, partly tightening the screws into the holes.
- Position the sealing gasket approximately 5-6 mm from the edge of the installation hole, matching up the two ends of the seal without overlapping.
- Insert the hob into the cutout, making sure it is positioned centrally and that the edge adheres to the sealant
- Position the hooks correctly, as shown in the figure, and then tighten the screws to hold them in place.

Range hoods

Range hoods and overhead exhaust fans must be installed according to manufacturers' instructions but in no case shall clearance from hob burners be less than 600 mm for range hoods and 750 mm for overhead exhaust fans.

Adjacent cabinetry

It is recommended that the adjacent kitchen surfaces should be capable of withstanding temperatures of 100°C.

Installation

Fitting the cooktop above an oven

When installing the cooktop above an oven, both the electric supply cable and the gas pipe or flexible hose must not touch hot parts of the oven housing.

When installing above a built-under oven without forced cooling ventilation, suitable air vents should be provided for as shown in the figure (inlet at least 200 cm² from the bottom, outlet at least 120 cm² from the top part) to allow adequate ventilation inside the housing unit.

Also a wooden panel "A" should be installed beneath the hob as insulation, positioning it at a minimum distance of 15 mm from the hob housing

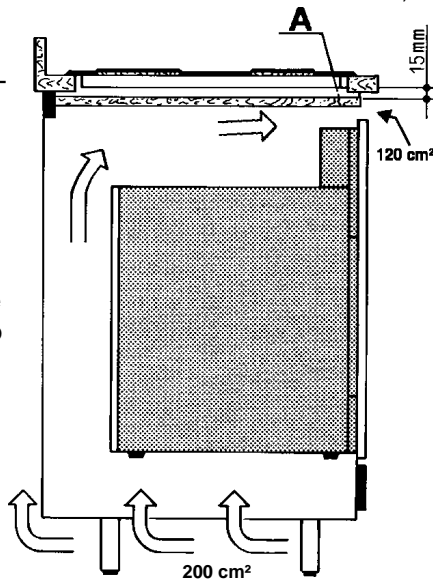

Gas connection

This appliance is suitable for use with either a flexible connection or rigid copper connection. If installing the appliance with a flexible connection, the flexible connection must be approved to class B or D of AS/NZS1869 as a minimum.

- Fit regulator supplied for Natural Gas (if applicable) at rear of appliance, and as close as practicable to the appliance.
- It is recommended that an isolating valve and union be fitted, to enable simple disconnection for servicing. These are to be in an accessible location.

Flexible hose

If a flexible hose is used, it should be as short as possible with a maximum length of 1.5 metres;

- it should not be bent or kinked;
- it should not be in contact with the rear wall of the appliance or in any case with parts which may reach a temperature of 50°C;
- it should not come into contact with pointed parts or sharp corners;
- it should be easy to inspect along its entire length in order to be able to check its condition.
- The supply connection point must be accessible with the appliance installed.

Electrical connection

- The electrical supply for the cooktop must be a 240 Volt 50 Hz.
- The fuse and electrical wiring of the home/premises must support the load of the appliance.
- The appliance must be earthed. A 3 pin flexible power cord is supplied with the appliance to allow the cooktop to be connected to a properly earthed and rated power socket.
- The flexible cord of the appliance must not be subject to direct heat and must be positioned after installation of the appliance so that its temperature does not exceed 75°C.
- IMPORTANT** If a power socket needs to be installed or relocated, the work must be done by a licensed electrician.

Gas type conversion

If the hob is to be converted for use with a type of gas other than that for which it was set in the factory (indicated on the cooktop data plate), the burner injectors must be replaced as follows:

- Remove the pan supports and the burners.
- Unscrew the injectors ("A" in figure below) using a 7 mm socket wrench, and replace them with injectors of suitable orifice diameter, as indicated on the appliance data plate.
- Reassemble the parts.

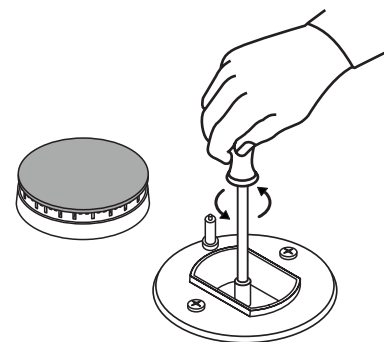

- If a regulator is required for the new gas type, instal an approved regulator of appropriate pressure setting and flow capacity.
- Replace the gas type label with one suitable for the new gas type.
- Perform the post installation checks as described later in this manual. In particular, check the turn down setting of each burner and adjust where necessary.

Perform post installation checks and ensure proper and safe operation before leaving. Test all burners individually and in combination.

Service Details

Post installation checks

Leak Check

- Ensure all gas control knobs are in the Off position.
- Ensure the gas supply is switched on.
- Spray a solution of soapy water onto all gas joints as well as the full length of any flexible hoses.

UNDER NO CIRCUMSTANCES USE A NAKED FLAME IN CHECKING FOR LEAKS.

If bubbles appear anywhere, turn the gas supply off, check all connections and retest. If satisfactory operation cannot be achieved, contact place of purchase or their appointed agent for service.

Flame check

Turn each burner on, and ensure that the flame is blue with minimal yellow tipping. If there is significant yellow tipping, flame lift off or excessive noise, check pressure and adjust at the regulator if necessary.

If satisfactory operation cannot be achieved, contact place of purchase or their appointed agent for service.

Igniter operation

Check that the igniter for each burner successfully ignites the gas.

If an igniter fails to work, first remove the plug from the electrical power outlet, and then check that all the electrical connections are in place.

If satisfactory operation cannot be achieved, contact place of purchase or their appointed agent for service.

Low flame setting

Check the low flame setting for each hob burner to ensure that the minimum flame will not be extinguished by air draughts.

- Light the burner.
- Turn the control until it engages in the minimum position.
- Ensure the flame is stable and will not be extinguished by air draughts.

To adjust the minimum flame:

Follow the procedure described in the gas conversion instruction.

DO NOT MODIFY THIS APPLIANCE IN ANY WAY.

Electrical equipment and components

To check or replace the ignition module

Electrical components are located below the hob surface. To access the components:

- IMPORTANT:** First ensure that gas and electrical power are disconnected before performing any service to this appliance.
- Remove the control knobs, trivets, burner caps and burner head assembly.
- Invert the cooktop and remove the two screws on the base near the gas manifold.
- Lift the base upwards. Take care to ensure that no damage occurs to the spark ignition leads or the igniter components.

The electronic ignition module is now easily accessible for service or replacement.

Assembly is a reversal of the above procedure.

To check or replace the gas controls and gas manifold

Gas components are located below the hob surface.

- Access the components underneath the surface of the hob as described in the previous section.
- Disconnect all ancillary gas piping, wiring and any screws, as appropriate.
- The gas manifold may then be extracted.

Replacement is a reversal of the above procedure.

ALWAYS PERFORM A LEAK CHECK AFTER PERFORMING ANY SERVICE. Correct procedure is at the top of this page.

Adjust turn down setting

- Put the tap to the low flame position;
- Remove the tap knob and turn the adjusting screw, situated inside the tap stem (fig.11), using a screwdriver (loosening the screw increases the height of the flame, tightening decreases it). note: the adjusting screw must be fully screwed down for liquid gas.
- Having obtained the low flame setting required and with the burner lit, abruptly change the position of the knob several times from minimum to maximum and vice versa and check that the flame does not go out.

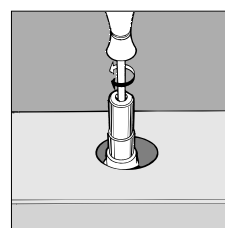

Troubleshooting

It may happen that the appliance does not function properly or at all. Before calling the service centre for assistance, check if anything can be done. First, check to see that there are any interruptions in the gas and electrical supplies, and, in particular, that the gas valves for the mains are open.

Problem	Likely cause
The burner does not light or the flame is not even around the burner.	The gas holes on the burner are clogged. The removable parts that make up the burner are mounted incorrectly. There are draughts near the appliance.
The burner does not remain lit when set to minimum.	The gas holes are blocked. There are draughts near the appliance. The minimum setting has not been adjusted properly.
The cookware is unstable.	The bottom of the cookware is warped. The cookware is not positioned correctly at the centre of the burner. The pan support grids have been positioned incorrectly.

Technical Specifications

Gas consumption

PZ 750	Injector diameter		gas input	
	Natural Gas (1.0 kPa)		Propane (2.75 kPa)	
Auxiliary	0.85 mm	3.3 MJ/hr	0.50 mm	3.3 MJ/hr
Semi Rapid (2)	1.10 mm	6.0 MJ/hr	0.64 mm	5.5 MJ/hr
Rapid	1.25 mm	9.4 MJ/hr	0.85 mm	9.0 MJ/hr
Wok Burner (Double Crown Double Ring)	0.85 mm + 2 x 1.25 mm	15 MJ/hr	0.5 mm + 2 x 0.75 mm	15 MJ/hr
total		39.7 MJ/hr		38.3 MJ/hr

PZ 640	Injector diameter		gas input	
	Natural Gas (1.0 kPa)		Propane (2.75 kPa)	
Auxiliary	0.85 mm	3.3 MJ/hr	0.50 mm	3.5 MJ/hr
Semi Rapid	1.10 mm	6.0 MJ/hr	0.64 mm	5.5 MJ/hr
Rapid	1.25 mm	9.4 MJ/hr	0.85 mm	9.0 MJ/hr
Wok Burner	1.75 mm	13.0 MJ/hr	1.01 mm	13.0 MJ/hr
total		31.7 MJ/hr		31.0 MJ/hr

Connections

	PZ 640	PZ 750
Gas Inlet fitting	1/2" BSP (male) thread	1/2" BSP (male) thread
Location of gas inlet	40 mm from rear edge 60 mm from right side edge	40 mm from rear edge 145 mm from right side edge
Electrical input	Flexible cord and earthed 10 Amp 3 pin plug	Flexible cord and earthed 10 Amp 3 pin plug
Location of Electrical Connection	55 mm from rear edge 200 mm from left side edge	50 mm from rear edge 250 mm from left side edge

General cleaning notes

DO NOT TOUCH HOT SURFACES, ALLOW COOKTOP TO COOL COMPLETELY BEFORE CLEANING.

- Always wipe spills up when they occur. Do not leave spills to dry onto the surface of the hob.
- It is usually enough to wash the hob with a damp sponge and dry it with absorbent kitchen roll.
- NOTE: Do not put hot components in cold water. The sudden temperature shock could cause the component to crack.
- Do not use abrasive or corrosive detergents such as stain removers, anti-rust products, powder detergents or sponges with abrasive surfaces: these may scratch the surface beyond repair.

Burners

- Wait for the cooktop to cool completely. Remove the burner cap and check the gas outlet holes for blockages. Clean with a soft bristle brush and warm soapy water.
- The removable parts of the burners should be washed frequently with warm water and soap and any burnt-on substances removed.

Service Schedule

To keep your cooker running smoothly, we recommend that you have your cooker serviced every 5 years by an authorised service agent.

Never use unauthorised technicians and never accept replacement parts which are not original.

Ignitors

- The terminal part of the electronic instant lighting devices should be cleaned frequently,

Enamelled parts (trivets)

- Never use abrasives, scouring pads or sharp objects. This will cause irreparable damage to the enamel.
- Clean the enamelled parts with soapy water when cold and wipe off with a clean, dry cloth. The enamel could dull if cleaned while still hot.

Stainless steel and chromed parts

- Stainless steel can be marked by hard water that has been left on the surface for a long time, or by aggressive detergents containing phosphorus. After cleaning, rinse and dry any remaining drops of water.
- Use commercial products designed for cleaning stainless steel and chromed steel, and follow the maker's instructions. Care should be taken when cleaning around graphics.
- Never use steam cleaners or pressure cleaners on the appliance.

Service and spare parts are available on the numbers below. Please have the following information handy:

- The appliance model (Mod.).
- The serial number (S/N).

This information can be found on the data plate located on the appliance and/or on the packaging.

ARISTON PRIORITY SERVICE

If you are not completely satisfied with your appliance or require service call:

Australia
Phone: 1300 815 589
New Zealand
Phone: (09) 306 1020

GENUINE ACCESSORIES & SPARE PARTS

A wide range of genuine accessories are available for your appliance call:

Australia
Phone: 03 9768 0888
New Zealand
Phone: (09) 306 1020

AUSTRALIA ARISIT PTY LIMITED

40-44 Mark Anthony Drive, Dandenong South,
VIC 3175, Australia
Fax: Service & Sales (03) 9768 0838
Email: consumer.care@arisit.com

NEW ZEALAND ARISIT PTY LIMITED

PO Box 68-140 Newton, Auckland
1145, New Zealand
Fax: (09) 302 0077 -
Email: sales@aristonappliances.co.nz