

**Users Guide & Installation  
Handbook**



Belling CTC60 Hob  
08 27451 01 @ 11.20010

**Belling  
CTC60**





## Service

---

### Calling for Service

Please consult your retailer in the first instance. If you experience difficulty contact Belling Appliances, After Sales Division.

Remember that you may be charged for the visit (even during the guarantee period) if nothing is found to be wrong with the appliance, so always check the instructions to make sure that you have not missed anything.

Belling Customer Care Centre  
Tel: 0844 815 3746 (all calls will be charged at local rate)

Before contacting a service agent, please note the following details about your cooker:

Model Number \_\_\_\_\_

Serial Number \_\_\_\_\_

Date of Purchase \_\_\_\_\_

Also note your Postcode \_\_\_\_\_

In order to provide a complete service history for your Belling appliance, please ask the service engineer to record the appropriate details in the chart below.

Date	Nature of Fault	Parts Replaced or Repaired	Authorised Stamp or Signature



Belling Stoney Lane, Prescott, Mersyside, L35 2XW

## Contents

---

Introduction	3
Installing Your Hob.....	4-6
For your own safety – Never / Always	7
Using a ceramic hob	8 - 12
Timer	13
Safety Features	14
Boost Function	15
Care of your hob...	16
Service	17



## Introduction

---

**Your Belling Hob** Thank you for purchasing a new Belling electric built-in hob. Its stylish and practical design will enhance your kitchen and make cooking a pleasure. Even if you have used an electric hob before, it is important that you read these instructions thoroughly before starting to cook, paying particular attention to the installation and safety instructions.

**Getting Help** If you have any problems with installing, operating, or cooking with your Belling hob, please check through these instructions thoroughly to make sure that you have not missed anything. If you still need help, then please contact (including a daytime telephone number if possible):

Customer Care Centre  
Stoney Lane,  
Prescot,  
Merseyside,  
L35 2XW

Belling Customer Care Centre Helpline: 0844 815 3746

Please quote the appliance model and serial number with all enquiries. This can be found on the rating plate on the underside of the appliance.

**WARNING! For your own safety, make sure that these instructions on installation, use and maintenance are followed.**

We advise you to keep these instructions in a safe place for future reference.

If you sell or transfer ownership of this product, please pass on these instructions to the new owner.

**Unpacking** Examine your hob for any damage, particularly the hob glass. Make sure there are no chips or cracks. If there is any damage to the hob or there is anything missing, please contact your supplier for advice. If the hob glass is cracked the appliance must not be connected to the supply, and no part of it may be used.

**Locating the hob** The hob can be fitted into any 600mm (24") deep work top with a thickness of between 30 and 40mm (1<sup>1</sup>/<sub>4</sub> to 1<sup>5</sup>/<sub>8</sub>"). The surface around the hob must be of a heat resistant material. The work top and its support must be strong enough to carry the weight of the hob plus full cooking pans.

The hob is a class X appliance, as such adjacent walls which project above hob level must not be nearer to the hob than 150mm and should be protected by heat resistant material. Any overhanging surface or cooker hood should not be nearer than 650mm.

We do not recommend positioning the hob below wall cupboards as heat and steam from cooking may cause damage to the cupboard and its contents.

**Note:** the pictures shown in the figures in this handbook are purely indicative.

## Care of Your Hob

---

In the interests of both safety and hygiene your Belling hob needs to be kept clean. A build-up of grease or fat from cooking may cause a fire hazard.

**WARNING! For your own safety, always switch off your hob at the mains supply before cleaning.**

### Ceramic Hob

**WARNING! If any crack should appear on the hob, isolate the cooker from the mains supply. Do not use any part of the cooker but contact your Belling Service Agent.**

The ceramic hob is very hard wearing and with normal care should remain in good condition. However, it is important that any spillage is dealt with before the hob is used again, otherwise it will become baked on.



Once the hob has cooled, remove any heavy spillage or soiling with a metal spatula or scraper, the hob surface should then be cleaned using a proprietary Ceramic Hob Cleaner and Conditioner on a damp cloth to remove any marks. Wipe off the residue of the cleaner with a soft damp cloth and polish the hob with a soft lint-free cloth. It is important that the hob is cleaned regularly with Ceramic Hob Cleaner & Conditioner as it provides a protective film to keep the hob in good condition and assists in keeping the hob clean.

Whilst it is recommended that normal cleaning is carried out when the hob has cooled, if jam, fruit or anything with a high sugar content is spilled on the hob, or plastic or aluminium is melted onto the hob, clean it off immediately, as damage to the hob can result. Switch off the hob and use a metal spatula, palette knife or scraper to remove the spillage. **TAKE CARE**, as the spillage and the hob may be very hot. When the hob has cooled, clean as usual with Ceramic Hob Cleaner & Conditioner.

Do not use scouring powders or paste, wire wool scouring pads, or oven cleaners on the hob as these can cause damage to the hob surface.

## Boost Function

The hob features a boost facility which enables pans to be brought up to temperature quickly with maximum power, before dropping to a lower energy setting automatically. It is activated as follows,

- To Activate Boost Function**
1. Switch on hob, as described previously.  
Touch pad  repeatedly until **9**. appears.  
The dot indicates that the boost function is activated.
  2. Touch pad  to reduce energy level to desired cooking energy level. It can be noted that the dot continues to be illuminated.

If an energy level less than 6 is selected, the boost function assumes a saucepan of liquid is to be simmered, so stays on full power for up to 7 minutes (dependant on setting) to bring the fluid to the boil quickly. If an energy level above and including 6 is selected, the boost function operates for less time, as if only a frying pan was being heated. As a guide, when energy level 7 or 8 is selected the boost function will run for around 3 minutes.

If no lower energy level is selected, the hob will resume normal operation, indicated by the dot switching off.

The table below should serve as an indication for suitable cooking energy levels.

Energy Level	Type Of Cooking
1 or 2	To dissolve butter, chocolate etc.
3	To heat food, keep small amounts of water simmering, to beat sauces containing egg yolk and butter. To simmer meat, fish, vegetables, fruit.
4 or 5	To heat solid and liquid foods, keep water boiling, unfreeze frozen foods, make omelettes containing 2-3 eggs, various types of cooking.
6	To cook foods, jams etc.
7 or 8	To seal meats and fry fish.
9	Frying potatoes etc., bringing water to boil.

## Installing your hob

Before cutting the work top, make sure that there is enough space underneath to accept the hob, and that there are no supports or projections which might interfere with fitting the hob.

Cut the aperture in the work top to the dimensions shown in the relevant diagram below, taking care that it refers to your hob. The cut edges of the aperture should be sealed with paint or varnish to prevent any ingress of moisture.

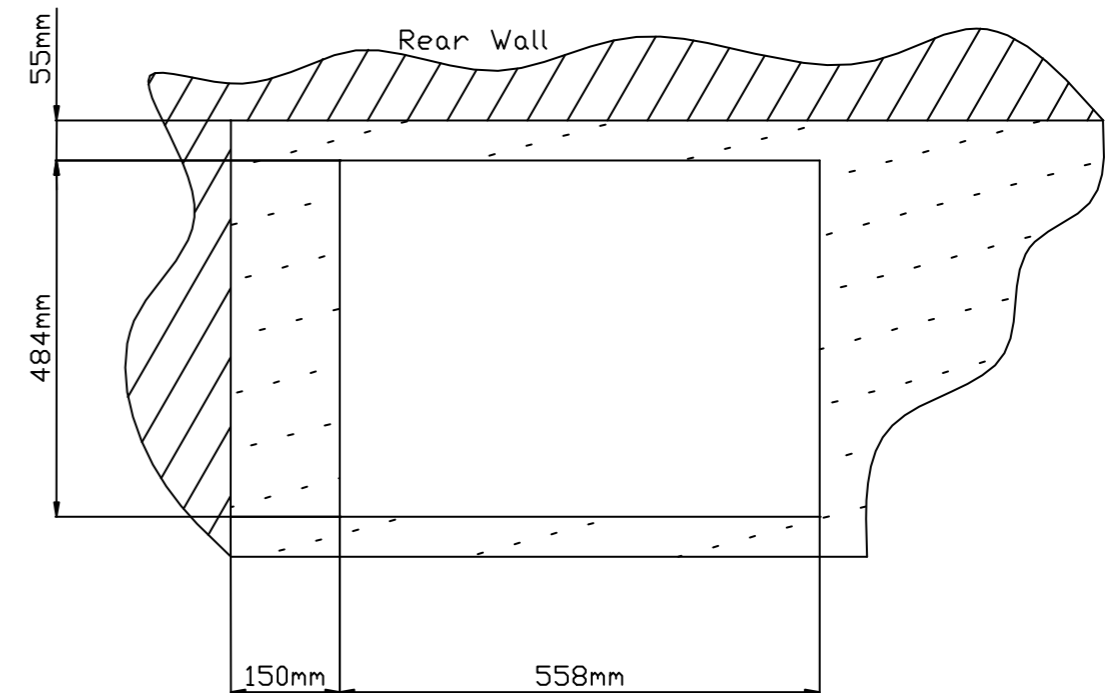

Note; A small radius is permissible in each corner.

## Installing your hob



**Connecting the hob** The connection to the electrical supply must be made before fitting the hob in the work top.

For your own safety, we recommend that your hob is connected by a competent electrician. The installation must comply with current I.E.E. Wiring Regulations.

### WARNING! THIS APPLIANCE MUST BE EARTHED!

The hob must be connected to the correct electrical supply as stated on the voltage label, located on the underside of the product, through a suitable double-pole control unit having a minimum contact separation of 3mm in all poles. We recommend that the circuit is rated to 32 Amps. We recommend P.V.C. insulated twin and earth cable with a conductor size of 4mm<sup>2</sup> to connect the hob to the mains supply. The maximum size of cable that can be used is 6mm<sup>2</sup> twin and earth, the minimum is 4mm<sup>2</sup>.

Access to the mains terminal block, for supply cable connection, is gained by removing the small plate on the underside front left hand corner of the hob. Pass the mains cable through the plastic grommet provided and secure it by using the cable clamp. Connect the mains cable as follows:

- Live to terminal 
- Neutral to terminal 
- Earth to terminal 

Allow sufficient cable length for the hob to be removed for maintenance, but ensure that the cable is looped well to the back of the cabinet and is kept clear of the base of the hob.

**Fitting the hob** Apply the self adhesive seal to the underside edges of the hob glass. For best results, the seal should be adhered along each side in turn, as close to the edge as possible, and trimmed at each corner, taking care to ensure a neat join.

Place the hob in the aperture, checking that the hob glass is covering the worktop along all four sides. Set the front edge of the appliance parallel with the front of the worktop. Locate and attach the securing clamps (x 2) to the front and rear underside of the hob, using the screws provided. Tighten the screws so that the hob is pulled down firmly against the worktop, thus ensuring a good seal.

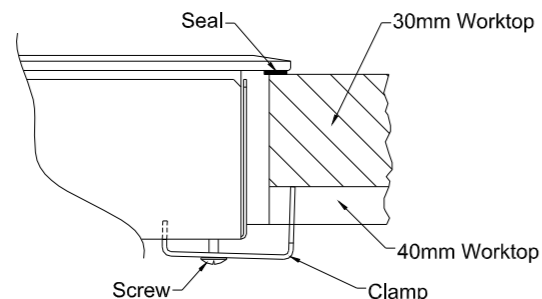

Note that the clamps are reversible to suit either 30mm or 40mm thick worktop.

## Safety Features

### Safety Lock

It is possible to lock the element controls and timer against accidental operation. At any time during the hobs use, if the pad marked  is touched for 2 seconds the controls will be locked i.e. they cannot be adjusted. The lock function is shown by its neon being illuminated. If the minute minder is in use at the time, it will continue to countdown as normal.

Touch the pad marked  for 2 seconds to remove lock

We recommend that the hob is locked whenever it is not in use, especially if children are likely to be present.

### Hob Hot Warning

When each plate is switched off after use, **H** will flash on the energy level indicator, to indicate that the plate is still hot. This will continue until the hob glass has cooled sufficiently to be safe to touch.

If the hob is switched off before the glass has cooled sufficiently, the **H** will be displayed continuously. This indicates to the user that the hob still retains heat following use. The **H** will go out when the hob surface has cooled sufficiently to be safe to touch.

**CAUTION! If the electricity supply to the hob is interrupted or switched off following use, the H hob hot indicators will not appear when the electricity supply is reinstated, despite the elements still being dangerously hot to touch.**

## Timer Operation

Your hob has a timer built in which can either be used to automatically switch off a cooking zone after a pre set period of time, or as an alarm reminder. The timer features a maximum duration of 99 minutes.

- Automatic cook stop**
1. Touch pad  $\triangle$ , on the timer controller, by the  $\text{⌚}$  symbol. A 't' will appear in each hotplate control display.
  2. Select the hotplate to be timed using the  $\triangle$  pad, and set to the desired energy level.
  3. Set the timer to the desired duration. Once the time period has elapsed the element will switch off and an alarm will sound. The alarm can be stopped by pressing any touch pad.
  4. To cancel a countdown duration, either reduce the time period to '0' using the  $\nabla$  pad, or press both  $\triangle$  and  $\nabla$  pads simultaneously.

- Alarm**
1. Set required energy level for elements required.
  2. Touch pad  $\triangle$ , on the timer controller, indicated by  $\text{⌚}$  symbol until the time duration required is reached.
- A 't' will appear in each hotplate control display. For Alarm only, it is not necessary to select a hotplate. After 10 seconds the controller will beep and the displays will revert to showing energy level.
- The alarm will sound once the time has elapsed, and can be stopped by pressing any of the touch pads.
3. To cancel an alarm duration, either reduce the time period to '0' using the  $\nabla$  pad, or press both  $\triangle$  and  $\nabla$  pads simultaneously.

## Installing your hob

### Belling built-under single oven unit or double oven unit

The hob can be fitted above a Belling built-under single or double oven unit if required.

For your own safety, we recommend that your hob and oven are connected by a competent electrician. The installation must comply with current I.E.E. Wiring Regulations.

Follow the installation instructions supplied with the oven unit. To make sure that there is adequate clearance between the top of the oven unit and the underside of the hob, the oven support shelf must be at least 615mm or 705mm from the underside of the worktop, depending on the type of oven being fitted, shown in the diagram below. Fit an infill piece along the underside front edge of the work top to form the top of the oven cavity where required.

Fit the hob before mounting the oven in its cavity, making sure that the cables are looped well to the back.

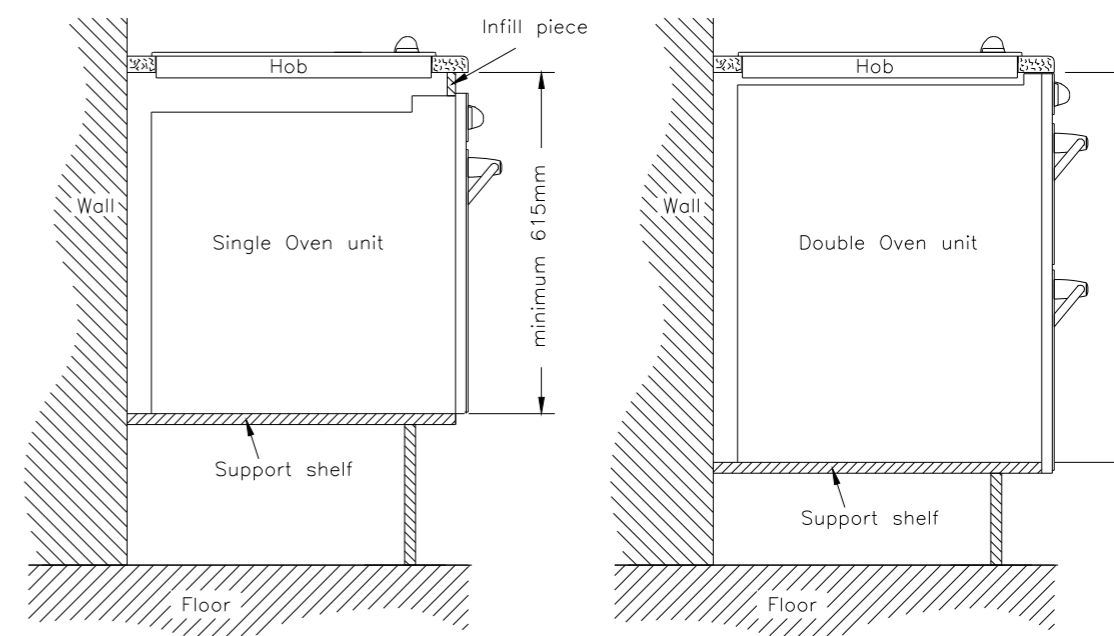

## For your safety

When used properly your Belling built-in hob is completely safe, but as with any electrical appliance there are some precautions you must take in its use.

### Never..

- Never allow anyone except an authorised Belling Service Agent to service or repair your hob.
- Never remove any part of the hob other than those intended in normal use, or attempt to modify the appliance in any way.
- Never use the cooker for commercial catering. It is designed for domestic use and for cooking food only.
- Never allow young children to operate or play with the cooker, as all surfaces get hot while in use.
- Never allow children to sit or stand on any part of the appliance.
- Never store items above a hob that children may attempt to reach.
- Never use a chip pan or deep fat fryer more than 1/3 full of oil, or use a lid while frying, and do not leave a fryer unattended while cooking.
- Never place materials which might catch fire, such as tea towels on the hob, even when the appliance is not in use.
- Never allow aluminium foil or plastic to touch any hob element when it is hot.
- Never use an asbestos mat, trivet or rack of any kind under pans on the hob.
- Never store anything which might catch fire in a cupboard immediately below the hob.
- Never heat unopened containers.
- Never place flammable or plastic items on or near the hob.
- Never dry clothes on the hob.
- Never store flammable liquids, aerosols, etc. in adjacent cabinetry.
- Never use large preserving pans or fish kettles across two hotplates as this will damage the hob.
- Never wear garments with long flowing sleeves whilst cooking.

### Always..



- Always take care when touching any part of the hob which may be hot.
- Always keep your hob clean, as a build-up of grease or fat from cooking may be a fire hazard.
- Always switch off at the mains supply and allow the appliance to cool before cleaning your hob.
- Always supervise children and pets whilst cooking
- Always use suitable pans for the hob, and make sure that they are stable.
- Always keep handles away from the edge of the hob and any heat. For added safety you should consider using a suitable hob guard.
- Always make sure that all the controls are switched off when you finish cooking.
- Always remember that your hob may stay hot for a time even after you have finished cooking.

## Using A Ceramic Hob

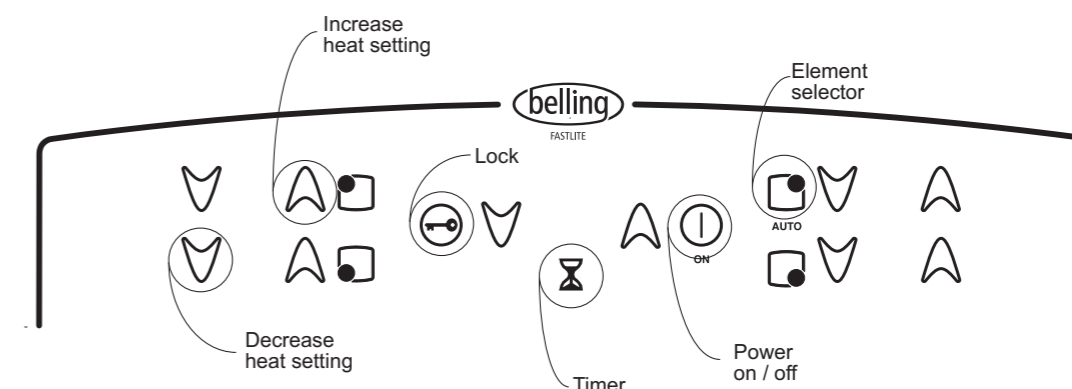
### Controls



When the hob is first switched the controller will illuminate parts of its displays, accompanied by a beep. This is the controller testing and calibrating itself. When this process is complete the neon adjacent to the lock pad will light, to indicate the hob is ready for use but locked for safety.

- To switch on**
1. Touch and hold the pad denoted with symbol  for 2 seconds. The hob will beep and the neon adjacent to the pad will switch off. The hob is now unlocked.
  2. Touch and hold the pad marked **ON** for 1 second. The hob will beep and all energy level indicators will display 0.
  3. Immediately touch pad  for the element you wish to use. Each touch of the pad raises the energy level by 1, up to a maximum of 9. Alternatively the pad can be held, in which case the energy level will run up to 9 by itself.
  4. To decrease the energy level touch .
  5. To set additional elements repeat steps 3 and 4.

**To switch off** To switch off an individual element, touch pad  until 0 appears or alternatively touch both energy level adjustment pads simultaneously.

To switch off the whole hob, hold the **ON** pad for 1 second, until the controller beeps. Alternatively, if all elements and timer are switched off individually, the hob will automatically switch itself off after 10 seconds.



## Using A Ceramic Hob

---

**WARNING: Extreme caution should be taken to avoid steam burns and hot surfaces when cleaning up spillage on the hot hob surface.**

1. Always clean up any spillage immediately with a clean cloth or a paper towel to avoid unnecessary damage to the hob.
2. When cooking food which contains sugar (most food) or syrup, use a utensil which is large enough to prevent boil over or spillage. **Sugar spillage will permanently damage the hob and therefore should be cleaned off with care immediately.** If sugar spillage has occurred, remove it as long as it is still hot with a metal handled razor-blade scraper commercially available. This will avoid any damage.

**NEVER LET IT COOL BEFORE REMOVING.**

Always ensure that the base of the utensil is dry before placing on the ceramic hob.

### **REMEMBER**

1. Purchasing a new pan will not necessarily mean it will have a flat base, always check before buying.
2. Using the correct pans and utensils will result in maximum contact with the hob and maximum efficiency as with any type of electric hob.

## Using A Ceramic Hob

---

Before using the hob for the first time, clean the hob surface with a Ceramic Hob Cleaner and Conditioner. This applies a thin protective film to the hob, making it easier to clean and prolong its life

All models feature a hob hot warning system. It will activate when any hob element is switched on and stay on after use, until the hob cooking zones cool to below a safe temperature, around 60°C.

**WARNING! If the power supply is interrupted, the hob hot warning will not operate upon resumption of power.**

Your new hob has 4 fastlite elements:

Back Left 1.2kW

Back Right 2.0kW

Front Left 1.8kW

Front Right 1.5kW

Lower rated elements (1.2kW) are better suited to smaller sized pans, while larger rated elements (2.0kW) are better suited to larger sized pans.

## Using A Ceramic Hob - Safety

### WARNING!

**If any crack should appear on the hob, isolate the hob immediately from the mains supply. Do not use any part of the hob but contact your Belling Service Agent.**

The ceramic hob elements are fitted with special controls to regulate the element temperatures and to prevent overheating. The elements will be seen to switch on and off during use as the temperature is maintained automatically. This cycling effect is perfectly normal, and is part of the designed operation of the elements and controls. A slight hum may be heard from the elements while they are in use.

Although the heating elements are fitted with safety cut-outs to prevent overheating, it is important that the elements are not operated for any length of time without a pan on the hob, as overheating can still occur and may cause damage.

Whilst it is recommended that normal cleaning is carried out when the hob has cooled, if jam, fruit or anything with a high sugar content is spilled on the hob, or plastic or aluminium is melted onto the hob, clean it off immediately, as damage to the hob can result. (See 'Care of your hob' on page 16)

### Safety requirements for deep fat frying

**IMPORTANT** – As with any cooking appliance there could be some fire risk attached to the heating of oil, particularly for deep fat frying, cooking utensils containing oil **must not be left unattended** (eg. to answer the telephone) on or in close proximity to the cooking zones. To minimise the risks inherent with deep fat frying, we recommend the following;

1. Use a deep pan, large enough to completely cover the appropriate heating area.
2. Never fill the pan more than one-third full of fat or oil.
3. Never leave oil or fat unattended during the heating or cooking period.
4. Do not try to fry too much food at a time, especially frozen food.  
This only lowers the temperature of the oil or fat too much, resulting in greasy food.
5. Always dry food thoroughly before frying, and lower it slowly into the hot oil or fat. Frozen foods, in particular, will cause frothing and spitting, if added too quickly.
6. Never heat fat, or fry, with a lid on the pan.
7. Keep the outside of the pan, clean and free from streaks of oil or fat.

### In the unfortunate event of a chip pan fire

1. Switch **Off** the electricity supply.
2. Smother flames with a fire blanket or damp cloth. Only if safe to do so.
3. Leave the pan to cool for at least 60 minutes before moving.  
If you cannot control the fire, close the kitchen door, evacuate the house and call the fire brigade. Do not go back into the house until you have been told it is safe to do so. Burns and injuries are almost invariably caused by picking up the burning pan and rushing outside with it.

## Using A Ceramic Hob – General Information

### NEVER

**Never** cook directly on the hob surface without a cooking utensil as this will result in damage to the surface of the hob.

**Never** use the hob as a worktop surface as damage may occur to the smooth sides of the hob.

**Never** drag or slide utensils on the hob surface, as this will cause scratches in the surface of the hob.

**Never** place anything between the base of the utensil and the ceramic hob, e.g. do not use asbestos mats, aluminium or wok stands.

**Never** leave any utensils, food or combustible items on the hob when it is not in use.

**Never** place aluminium or plastic foil, or plastic containers on the hob.

**Never** leave the hotplates or cooking areas switched ON unless they are being used.

We recommend not to place large preserving pans or fish kettles across two heated areas.

**Never** leave utensils partly covering the heated areas. Always ensure that they are placed centrally over the heated areas and have the same diameter as the heated area used.

We recommend not to use a utensil with a base diameter greater than 25cm (10").

### ALWAYS

**Always** use good quality smooth flat based utensils.

**Always** use a utensil which has approximately the same base area as the heating area zone being used.

**Always** use utensils which have more than sufficient capacity for the amount of food being cooked to prevent boil over or spillage.

**Always** use utensils with good fitting lids.

**Always** use a low dome pressure cooker for best results. saucepans with smooth flat bases. Aluminium pans with coloured vitreous enamelled bases absorb heat and are therefore more efficient in use. Almost equally as good are saucepans with a thick machined aluminium base. If using enamelled steel or cast iron pans, ensure that they have good smooth flat bases as otherwise the heat will not be distributed evenly and damaging heat spots may be created.

**Never** use recessed or ridged base utensils. Ideally the base of saucepan should be approximately the same size as the heating area, up to a maximum of 254mm (10").

