

**clarion®**

Owner's manual

***VMA5096***  
***VMA7196***

**5" and 7" WIDE SCREEN COLOR LCD MONITOR**

Thank you for purchasing this **Clarion** product.

- Please read this owner's manual in its entirety before operating this equipment.
- After reading this manual, keep it handy, such as in your glove compartment.

## FCC Approval

---

This equipment has been tested and found to comply with the limits for a Class B digital device, pursuant to Part 15 of the FCC Rules. These limits are designed to provide reasonable protection against harmful interference in a residential installation. This equipment generates, uses, and can radiate radio frequency energy and, if not installed and used in accordance with the instructions, may cause harmful interference to radio communications. However, there is no guarantee that interference will not occur in a particular installation. If this equipment does cause harmful interference to radio or television reception, which can be determined by turning the equipment off and on, the user is encouraged to consult the dealer or an experienced radio/TV technician for help.

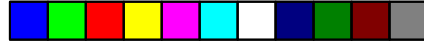

# Contents

English

<b>1. FEATURES</b> .....	<b>4</b>
<b>2. PRECAUTIONS</b> .....	<b>5</b>
Installation .....	5
Please Note .....	5
<b>3. CONTROLS</b> .....	<b>6</b>
Wireless headphones .....	6
<b>4. OPERATIONS</b> .....	<b>7</b>
Turning the unit off and on .....	7
Playing a video or game .....	8
Adjusting the picture .....	8
Switching between video sources .....	9
Playing two videos or games at once .....	9
Changing the video output mode .....	10
Disabling automatic power on .....	10
Returning adjustments to the factory settings .....	10
Connecting a video source .....	10
Care and maintenance .....	10
<b>5. OPERATIONS OF ACCESSORIES</b> .....	<b>11</b>
Using a remote control .....	11
<b>6. INSTALLATION AND WIRING</b> .....	<b>11</b>
What is included in the box .....	11
Before starting .....	12
Installing the monitor .....	12
Wiring the monitor .....	15
<b>7. TROUBLESHOOTING</b> .....	<b>17</b>
<b>8. SPECIFICATIONS</b> .....	<b>18</b>
General specifications .....	18
Monitor specifications .....	18
<b>9. LIMITED WARRANTY INFORMATION</b> .....	<b>19</b>

## 1. FEATURES

The Clarion 5-inch VMA5096 and 7-inch VMA7196 are high-performance video monitors designed specifically for the mobile environment. Intended for use with other Clarion multimedia products, the monitors can be integrated with many other products as part of a complete mobile video solution.

Two video inputs support simultaneous connection to both dedicated video source units and optional audio/video components, such as camcorders or videogames.

- Infrared remote control receiver output allows integration with select Clarion DVD and VHS source units.
- Automatic switch between NTSC and PAL video signals allows operation with either standard (NTSC is the standard North American video format).
- 16:9 aspect ratio allows viewing of DVD films in their original aspect ratio for the best cinematic experience (widescreen).

### WARNING!

***The monitors are designed to be viewed by rear-seat occupants.***

***Digital video products are not intended for viewing by the driver while the vehicle is in motion. Such use may distract the driver or interfere with the driver's safe operation of the vehicle, and thus result in serious injury or death. Such use may also violate state law.***

***Clarion disclaims any liability for any bodily injury, including fatalities, or property damage that may result from any improper or unintended uses of this product.***

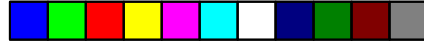

## 2. PRECAUTIONS

- Do not operate your monitor in ways other than those described in this manual.
- Do not play a multimedia system when the car's engine is turned off. Doing so runs down the car's battery.
- Do not disassemble or modify the monitor.
- Keep moisture away from the monitor. Water and humidity may damage internal circuitry.
- Do not let the monitor become overheated. If the temperature in the vehicle is high or the monitor has been exposed to direct sunlight, cool the monitor (such as, by running the air conditioning) before you turn it on.
- Keep all liquids, including beverages and cleaning fluids, away from the monitor. Liquids in the monitor can damage the electronics and result in electrical shock or fire. If the unit becomes wet, turn off all power and contact an authorized Clarion dealer to have the monitor inspected.
- Never press on the liquid crystal display (LCD) panel. You may damage it.

Failure to observe these precautions may damage your car, the monitor, or the video source, and may void the warranty.

### Installation

Installation of mobile audio and video components requires experience with a variety of mechanical and electrical procedures. Although this manual provides general installation and operation instructions, it does not show the exact installation methods for your particular vehicle.

If you do not have the required knowledge and experience to successfully complete the installation, consult an authorized Clarion dealer about professional installation options.

### Please Note

In extremely cold weather the movement of the picture may slow and the picture may darken. The picture will return to normal once the temperature rises.

You may see small black or shiny dots in the liquid crystal panel. These non-conforming pixels are normal and do not indicate a product defect.

### 3. CONTROLS

Transmit infrared signals to the 2 ch. IR headphones (hidden behind plastic)

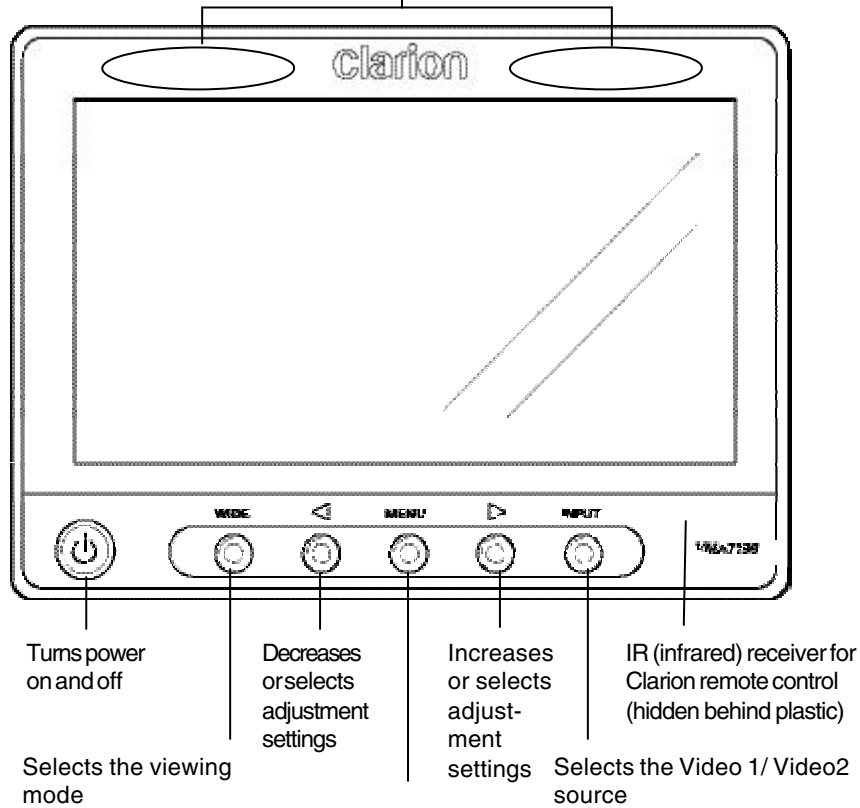

Accesses the display adjustment menus. Each time you press this button the unit steps to the next setting option and displays the current setting.

### Wireless headphones

**Power OFF/ON**

turns the headphones power on and off.

**CH.A and CH.B**

select the infrared channel if you have two monitors and two video source units (Configuration 2).

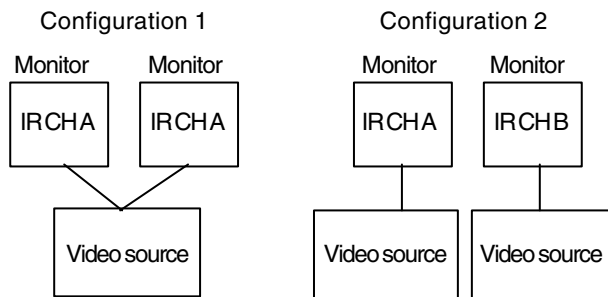

English

You don't need to select the IR channel if you have only one monitor or two monitors and only one video source (Configuration 1—both monitors play the same video or game).

## 4. OPERATIONS

Your monitor is a component of a full audio/video system that may include a VCR, DVD player, game player, camcorder or other video source unit.

### Note

*If you have any questions about compatible components, such as system controllers, source units, FM modulators or other audio/video products, contact your authorized Clarion dealer.*

To operate the monitor, the vehicle ignition key switch must be in the ACC or ON (run) position.



*Key in the ACC or engine ON position*

### WARNING!

***To prevent the battery from going dead, always operate this unit with the engine running, if possible.***

## Turning the unit on and off

The video source unit, such as a DVD player, may turn on automatically when you turn the ignition on. Press the power button at any time to turn the monitor off.

When you turn the vehicle's ignition off, the monitor automatically shuts off.

## Playing a video or game

Your monitor is preset at the factory to turn on automatically when you start your car's ignition. The monitor remains dark until it detects a video signal.

1. Insert the media (tape, cartridge, game or disc) into the video source.
2. Turn on the headphones.

If this is the first time you've used the unit, make sure your headphones have fresh batteries installed.

### Note

*Your headphones must be in view of the monitor for the infrared transmission to work.*

3. Press play on the video source.
4. When you see the picture, press **WIDE** to select the display mode.

Depending on the video source, the following display modes are possible.

**CINEMA** may stretch the image to fill the entire screen.

**NORMAL** displays the image at its true aspect ratio (4:3)

**WIDE** stretches the image horizontally to fit the screen (aspect ratio of 16:9).



Aspect ratio comparisons

### Notes

- When using a DVD player as the source, make sure that the unit's output mode is set to "Wide" or "16:9." This ensures that the DVD player will generate a video signal, which can take advantage of the monitor's aspect ratio.
- When using a source that generates a "normal", 4:3 image signal, such as a videogame or videocassette player, the **WIDE** button stretches the image to fit the screen. Some minor image distortion may be visible.

## Adjusting the picture

If the temperature is normal and the picture still doesn't look right, you may adjust the tint, color, brightness, and contrast.

1. Press **MENU** to display the adjustment menus.  
The monitor displays the adjustment menus.





2. Press **MENU** again until you reach the option you wish to adjust.

The monitor displays the adjustment bar.



*Example of an adjustment bar*

- TINT adjusts the overall color of the monitor.
- COLOR adjust the way each color displays.
- BRIGHT adjusts the monitor's brightness.
- CONTRAST adjusts the differences between light and dark areas.

3. Press the right  end of the picture controls button to increase the adjustment.

Press the left  end of the picture controls button to decrease the adjustment.

Each setting has 30 steps of adjustment range and is preset at the factory to 15. Once you've adjusted the picture, wait a moment and the adjustment menus disappear.

## Switching between video sources

If your vehicle has two video sources, for example, a DVD player and a game console, you can easily switch between them.

1. Press **INPUT**.

The monitor displays A/V1.

2. Press **INPUT** again to select A/V2.



### **Note**

*If you're using only one video source, the screen remains dark when you select the unavailable source.*

## Playing two videos or games at once

If your vehicle is equipped with two LCD monitors in the headrests and two video source units, two different videos or games can play at the same time.



Each monitor transmits the infrared audio signal over its own channel, A or B. When a vehicle has two monitors, the default is to configure the monitor in the driver's headrest to use IR channel A, and the monitor in the passenger's headrest to use IR channel B. You can change this.

1. Press **MENU** several times to locate the IR CH option.
2. Press  or  to alternate between A and B.

### **Note**



*You don't need to select the IR channel if your vehicle has only one monitor or only one video source.*

## Changing the video region mode (NTSC/PAL)



1. Press **MENU** several times to locate the VIDEOSYS option.
2. Press  or  to alternate between NTSC and PAL.

## Disabling automatic power on

Your monitor is preset at the factory to switch on when you turn on your vehicle's ignition. You can set it up to remain off until you press the power button on the monitor.

1. Press **MENU** several times until you reach the AUTOPOWER option.
2. Press  or  to turn automatic power ON and OFF.

## Returning adjustments to the factory settings

1. Press **MENU** several times to locate the RESET option.
2. Press either  or  to reset the settings.

If you don't wish to reset the settings, either press **MENU** again or wait for the monitor to exit the picture adjustment menus automatically.

### Note

*If you reset the options and the monitor was set to source 2 (A/V2), the monitor reverts to the default setting of A/V1. If there is no active video source on A/V1, the screen may go dark. Press **INPUT** to switch the monitor back to A/V2.*

## Connecting a video source

The video sources you are using may be preinstalled for you, or your configuration may be designed to allow you to change devices.

For example, returning from a day at the beach, you may disconnect your game from the game port and connect your camcorder to view the video you just shot.

### CAUTION!

***Always take care when disconnecting and connecting electronic devices.***

## Care and maintenance

### Cleaning the cabinet

Use a soft, dry cloth to gently wipe dust and dirt from the cabinet.

Do not use benzene, thinner, car cleaner, or other cleaners. These substances may damage the cabinet or cause the paint to peel.



### ***Cleaning the LCD panel***

Use a soft, dry cloth to gently wipe off dust. The LCD panel surface can be easily scratched. Do not rub it with any abrasive object.

### ***Servicing the monitor***

In the event that trouble arises, never open the case or disassemble the unit. The internal parts are not serviceable by the user. Opening any components will void the warranty.

### **CAUTION!**

***Changes or modifications to this product not approved by the manufacturer will void the warranty and will violate FCC approval.***

## **5. OPERATIONS OF ACCESSORIES**

### **Using a remote control**

The LCD monitor comes with an IR receiver that works with Clarion remote control devices. Aim the remote control at the IR receiver during use.

#### **Note**

*The IR receiver only functions with select Clarion multimedia equipment.*

## **6. INSTALLATION AND WIRING**

Read these instructions and the following precautions carefully.

### **What is included in the box**

In addition to this manual, the box contains:

- 5" VMA5096 monitor or 7" VMA7196 monitor
- The flush mount bracket
- Monitor release tool
- 1 - 16 Pin main cable

## Before starting

Disconnect the ground (-) terminal on the vehicle's battery.

### WARNING!

*To prevent short circuits during installation, be sure to disconnect the battery.*



### Precautions

- This unit is exclusively for vehicles with a negative ground, 12V power supply.
- Do not open the case. There are no user-serviceable parts inside. If you require assistance, consult your Clarion dealer or an authorized Clarion service center.
- Use a soft, dry cloth to clean the screen. Never use a rough cloth, thinner, benzene, alcohol, or other solvent. The screen surface is easy to scratch—do not rub it when cleaning.
- Always use great care when attaching anything to a vehicle! Visually inspect all sides of any potential screw location to ensure no damage will occur.

### WARNING!

*NEVER install this monitor where it is visible from the driver's seat, or where it could injure any vehicle occupant in case of an accident. Ensure that your installation does not create risk of head-strike injury, and that the monitor will remain securely mounted in the case of an accident or sudden maneuver.*

## Installing the monitor

These TFT LCD monitors are designed for custom installation. While a basic flush-mount bezel is supplied, you may need parts that are not included (depending on your installation). Clarion also offers optional mounting kits:

- The ZMT003 is a flexible gooseneck mount.
- The PQE023 positions the monitor on the back of a vehicle headrest.

### Note

*The Clarion HRM100 and HRM150 headrest mounting kits are not compatible with this monitor.*

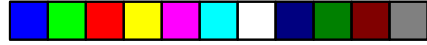

### ***Flush mounting in the headrest***

You may use the included trim bezel to flush-mount the monitor.

1. Ensure that you will have sufficient clearance for the monitor and its rear-located wiring harness.
2. Cut the opening.
3. Route the DIN-connector end of the wiring harness into the opening from the rear out the front.
4. Insert the trim bezel and route the wiring harness through the opening in the rear.
5. Firmly attach the bezel to the mounting surface and/or to the interior of the mounting surface.

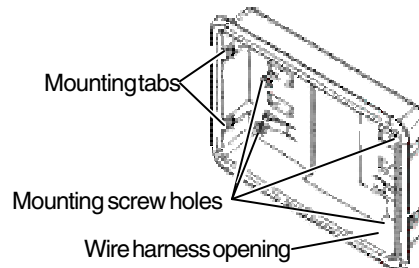

*Bezel*

6. Connect the wiring harness to the monitor, and tuck the excess wiring harness length carefully out of the way behind the bezel.

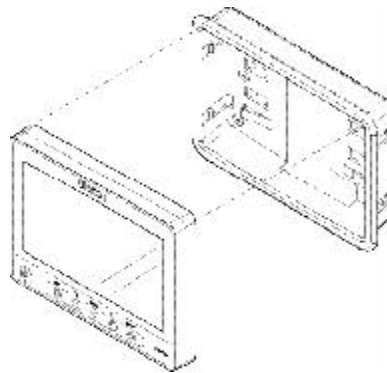

*Monitor and bezel*



English

7. Gently insert the monitor into the bezel.

Press only on the edges of the monitor, not on the screen. You should hear a few soft clicks as the monitor locks into place.

**CAUTION!**

***NEVER press on the surface of the screen! Gently press on the edges of the monitor case. If you find that you cannot insert the monitor without excessive force, you may need to check your wire harness position for interference with the insertion process. You may also need to make the opening slightly larger.***

***Removing the monitor from the bezel***

To remove the monitor from the bezel, insert the flat card (included in the box) between the monitor case and the side of the bezel to release the spring clips.

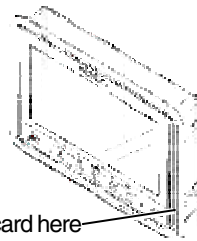

Insert card here

*Bezel with monitor mounted*

***Custom mounting using the threaded insert***

The monitor base has a threaded insert (1/4 - 20) that can be used with the optional Clarion ZMT009 gooseneck mounting kit or with a 1/4 -20 machine screw in custom applications.

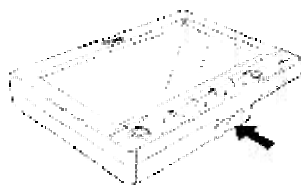

*Location of the threaded insert*

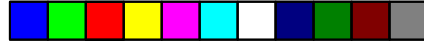

## Wiring the monitor

### Precautions

- Disconnect the negative battery terminal before making any wiring connections.
- Be particularly careful where you route wires. Keep them away from the engine, exhaust system, etc. Heat may damage wires.
- If the fuse should blow, make sure all connections are correct and no wires are damaged before replacing the fuse. Always use fuses that are the same amperage value as the original. When replacing a fuse, never let the battery side touch any metal part or any other wire.

### WARNING!

***Be sure to disconnect the battery (-) terminal before starting.  
This is to prevent short circuits during installation.***



Car battery

### Procedure

1. Disconnect the negative (-) lead from the vehicle's battery.
2. Find a place in the vehicle for the video source(s).
3. Create passage holes for the power and video cables.

When drilling through metal or plastic, use grommets to protect the cables from sharp edges that could penetrate the insulation and cause a short circuit and device failure.

4. Connect the ground lead (black) securely to a clean metal plate on the vehicle.  
Use sand paper to remove any paint from the surface where you attach the ground terminal.
5. Reconnect the negative (-) lead to the battery.

**Monitor connections**

**CAUTION!**

*Some non-Clarion automotive DVD and VCP source units use a similar connector for an external IR receiver, but use different pin polarity than the Clarion uses. Connecting non-Clarion source equipment to this connector could cause equipment damage not covered by the warranty!*

**IR connector polarity**

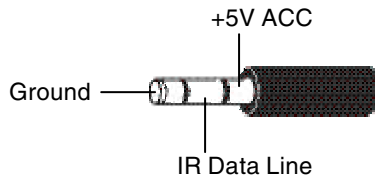

**Connections diagram**

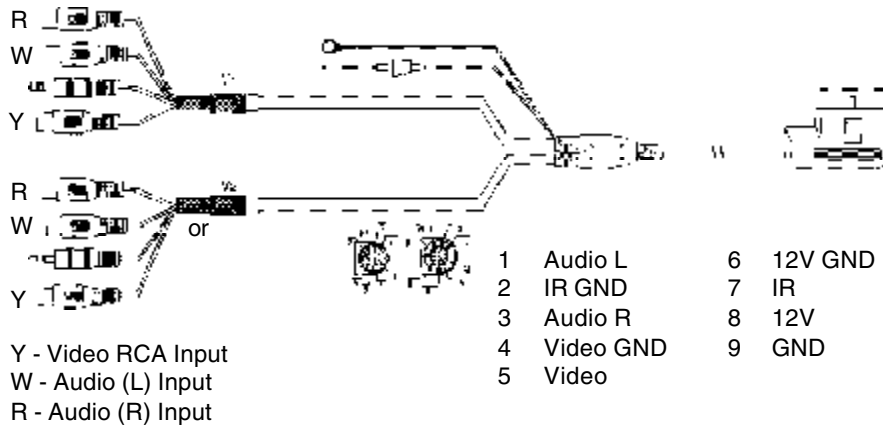



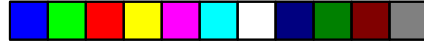

## 7. Troubleshooting

### **The monitor does not turn on**

A fuse may be blown. Replace the external fuse with a fuse of the same value.

The power wires may not be connected. Check the wiring connections and retest.

### **No picture.**

Press **INPUT** to make sure the proper input is selected.

If there is still no picture, press **MENU**. If the menu appears, check the source unit and video connections. If no menu appears, check all fuses and power connections to the monitor and the associated equipment.

#### **Note:**

*The monitor has an operating temperature range of -1° C to 45° C (30° F - 113° F). If the temperature is outside this operating range, the unit will not turn on, or the screen may be slow to react to image changes. The monitor will function normally once it returns to its proper operating range.*

### **There are black bars above and below the picture with widescreen DVD disc**

Change the monitor display mode from "Full" to "Wide." Access DVD player's Setup menu.

After changing this setting, if there are still black bars, press **WIDE** on the front panel of the monitor and select WIDE.

### **The screen is dark**

The brightness is set too low. Press **MENU** and adjust the BRIGHT option.

The interior of the vehicle is too hot or too cold. The monitor's operating temperature is 1 degree to 45 degrees Celsius (30 degrees to 113 degrees Fahrenheit).

### **Picture "rolls" or appears B/W**

Check that the VIDEOSYS setting is correct for the monitors and DVDs being used (see "Changing the Video Output Mode"). PAL video often "rolls" on NTSC monitors.

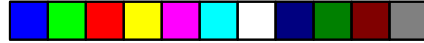

## 8. Specifications

### Note

*The technical data and the design of the equipment may change without prior notice for the sake of technical improvements.*

### VMA5096 General Specifications

Power requirement:	12V DC (9V-16V)
Power consumption:	6.5 watts, power on 0.6 amps (600mA)
Weight:	300 g
Dimensions (w x h x d):	138 x 106 x 26.5 mm
Included parts:	LCD monitor 1 - 16P Main cable 1 - Mounting bracket Monitor release tool

### VMA5096 Monitor Specifications

Display type:	Color TFT Active Matrix LCD
Screen size:	5"
Pixels:	960 x 220
Screen resolution:	211,200 dots
Video input level (RCA)	1.0 volts peak to peak, NTSC

### VMA7196 General Specifications

Power requirement:	12V DC (9V-16V)
Power consumption:	6.5 watts, power on 0.6 amps (600mA)
Weight:	345 g
Dimensions (w x h x d):	183.2 x 128 x 29 mm
Included parts:	LCD monitor 1 - 16P Main cable 1 - Mounting bracket Monitor release tool

### VMA7196 Monitor Specifications

Display type:	Color TFT Active Matrix LCD
Screen size:	7"
Pixels:	1440 x 234
Screen resolution:	336,960 dots
Video input level (RCA)	1.0 volts peak to peak, NTSC

## 9. LIMITED WARRANTY INFORMATION

### For USA and Canada only

Except as noted, Clarion products purchased from an authorized Clarion dealer are warranted against all defects in materials and workmanship for a period of one (1) year from date of original purchase.

The following Clarion products noted below \*\* are warranted against all defects in materials and workmanship for a two (2) year period from the date of original purchase when purchased from **AND** installed by an authorized Clarion dealer.

\*\* DRZ9255 DXZ865MP DXZ765MP DXZ665MP DXZ465MP DFZ675MC DPX1150 DPX1800 DPX2250

All Clarion cables, wires and other accessories if purchased from an authorized Clarion dealer are warranted against all defects in materials and workmanship for ninety (90) days from the date of original purchase.

### **ALL PURCHASES OF CLARION PRODUCTS FROM NON-AUTHORIZED CLARION DEALERS ARE SUBJECT TO FURTHER WARRANTY RESTRICTIONS AS DESCRIBED BELOW.**

The conditions of this Limited Warranty and the extent of responsibility of Clarion Corporation of America ("Clarion") under the Limited Warranty are as follows:

- 1. PROOF OF DATE OF PURCHASE FROM AN AUTHORIZED CLARION DEALER WILL BE REQUIRED FOR WARRANTY SERVICE OF THIS PRODUCT. IN THE CASE OF THE TWO (2) YEAR LIMITED WARRANTY FOR THE CLARION PRODUCTS NOTED ABOVE, PROOF OF DATE OF PURCHASE AND PROOF OF INSTALLATION BY AN AUTHORIZED CLARION DEALER IS REQUIRED. INFORMATION ABOUT CLARION AUTHORIZED WARRANTY SERVICE CENTERS MAY BE OBTAINED BY CONTACTING CLARION AT THE ADDRESS LISTED BELOW.**
- This Limited Warranty will become void if service performed by anyone other than an approved Clarion Warranty Service Center results in damage to the products.
- This Limited Warranty does not apply to any product which has been subject to misuse, neglect or accident, or which has had the serial number altered, defaced or removed, or which has been connected, installed, adjusted or repaired, other than in accordance with the instructions furnished by Clarion.
- This Limited Warranty does not cover car static or other electrical interferences, tape head or laser pick-up cleaning or adjustments, or labor costs for the removal or reinstallation of the unit for repair.
- The sole responsibility of Clarion under this Limited Warranty shall be limited to the repair of the product or replacement of the product, at the sole discretion of Clarion.
- Product must be shipped in its original carton or equivalent carton, fully insured, with shipping charges prepaid. Clarion will not assume any responsibility for any loss or damage incurred in shipping.
- 7. CLARION PRODUCTS PURCHASED FROM A SOURCE OTHER THAN AN AUTHORIZED CLARION DEALER, INCLUDING ANY AND ALL PURCHASES VIA THE INTERNET FROM A NON INTERNET AUTHORIZED CLARION DEALER, SHALL NOT BE COVERED BY ANY CLARION LIMITED WARRANTY TO THE EXTENT ALLOWED BY APPLICABLE LAW. IN THE EVENT AND TO THE EXTENT APPLICABLE LAW PROHIBITS ELIMINATION OF WARRANTIES UNDER THESE CIRCUMSTANCES, THE APPLICABLE LIMITED WARRANTY PERIOD SHALL BE DEEMED TO BE FIFTEEN (15) DAYS FROM THE DATE OF ORIGINAL PURCHASE.**
- 8. ALL IMPLIED WARRANTIES EXCEPT TO THE EXTENT PROHIBITED BY APPLICABLE LAW SHALL HAVE NO GREATER DURATION THAN THE WARRANTY PERIOD SET FORTH ABOVE. UNDER NO CIRCUMSTANCES SHALL CLARION BE LIABLE FOR ANY LOSS OR DAMAGE, DIRECT OR CONSEQUENTIAL, ARISING OUT OF THE USE OR INABILITY TO USE THE PRODUCT. BECAUSE SOME STATES DO NOT ALLOW LIMITATIONS ON HOW LONG AN IMPLIED WARRANTY LASTS OR EXCLUSIONS OR LIMITATIONS OF INCIDENTAL OR CONSEQUENTIAL DAMAGES, THE ABOVE LIMITATIONS OR EXCLUSIONS MAY NOT APPLY TO YOU.**
- 9. THIS LIMITED WARRANTY GIVES YOU SPECIFIC LEGAL RIGHTS, AND YOU MAY ALSO HAVE OTHER RIGHTS WHICH VARY FROM STATE TO STATE.**
- The laws of the state of California shall govern and control this Limited Warranty, its interpretation and enforcement.
- Should you have any difficulties with the performance of this product during the warranty period, please call Clarion or visit our web site for a listing of Authorized Warranty Service Centers in your area. You may also contact Clarion Customer Service at the address listed below for any service you may need with Clarion products.

In USA  
Clarion Corporation of America  
Attn: Customer Service Manager  
661 W. Redondo Beach Blvd  
Gardena, CA. 90247-4201  
1-800-GO-CLARION (310)327-9100  
www.clarion.com

In Canada  
Clarion Canada, Inc.  
Warranty Service Center  
2239 Winston Park Drive  
Oakville, Ontario L6H 5R1  
(905)829-4600  
www.clarioncanada.com

VMA5096/VMA7196

19



## **Clarion Corporation of America**

All Rights Reserved. Copyright © 2006: Clarion Corp. of America  
Printed in China

VMA5096/VMA7196

