

ORECK®

STEAM-IT™

All Purpose Steam Wand

STEAM100

User's
Guide

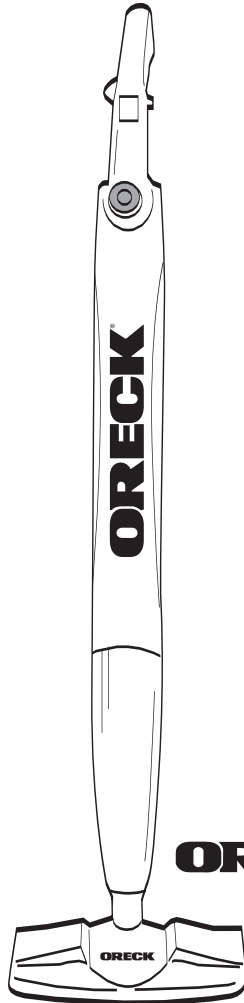

ORECK clean home™
HEALTHIER. EASIER. SMARTER.™

Important!

Read all instructions carefully, and keep for future reference.

Contents

Safety 3

Parts 5

 Product Components & Accessories 5

Operation 6

 Operating Instructions 6

 Using the Steam-It™ 6

 Cleaning Surface/Steam Setting Reference 7

 Carpet Cleaning 7

 For Large Carpeted Areas 7

 Stubborn Stains 8

 Carpet Pile Rejuvenation 8

 Hard Floor Cleaning 8

 Attaching an Accessory 8

Maintenance 10

 After Each Use 10

 Cleaning the Steam Generator 10

 Unblocking the Steam Outlet 10

 Cleaning the Cloth 10

Troubleshooting 11

Warranty 12

Enjoy

Thank You for purchasing an Oreck Steam-It™ All Purpose Steam Wand! This state of the art steam wand will help you have a cleaner, healthier home. At Oreck, we understand that our customers are unique and expect superior service. To meet your needs, we offer different customer service options to work with your lifestyle and preferences.

Welcome to our **Call. Click. Visit.** customer service program.

Call



To speak with an Oreck representative call:
 USA: **1-800-989-3535**
 Canada: **1-888-676-7325**

Click



On the web, point and click at: **www.oreck.com** or visit www.oreck.com and click locate a store on the top right

Visit



Visit us in person at one of over **450** store locations. To find the nearest store, please call **888-oreckstore** (888-673-2578) or visit **www.oreckstore.com**.

Safety

General Warnings

**IMPORTANT SAFETY INSTRUCTIONS!**

When using an electrical appliance, basic precautions should always be followed, including the following:

READ ALL INSTRUCTIONS BEFORE USING THIS STEAM CLEANER**WARNING! To reduce the risk of fire, electric shock, or injury:**

- Do not leave the steam cleaner unattended when plugged in. Unplug it from the socket when not in use.
- To prevent electric shock do not use outdoors.
- Not to be used as a toy. Close supervision is necessary when used near children.
- Use only as directed in this manual.
- Do not use with damaged cord or plug. If appliance is not working as it should, has been dropped, damaged, left outdoors, or dropped into water, return it to a service center or call customer service at:
USA: 1-800-989-3535 Canada: 1-888-676-7325
- Do not pull or carry by the cord, use the cord as a handle, allow the cord to come into contact with hot or sharp surfaces or close a door on the cord.
- Do not unplug by pulling on the cord.
- Do not handle the plug or cleaner with wet hands.
- Do not put any objects into openings or operate with openings blocked.
- Do not use without the tank cap in place.
- Turn off all controls before unplugging.
- Do not use an extension cord.
- Store indoors, put away after use to prevent tripping accidents.
- Using improper voltage may result in damage to the steam cleaner and possible injury to the user. The correct voltage is listed on the rating label.
- This steam cleaner is intended for household use only.
- A hazard may occur if the steam cleaner runs over the power cord.
- Never immerse the steam cleaner in water or other liquids.
- The steam cleaner is not suitable for outdoor use.
- Do not operate the steam cleaner without water in the tank.
- Empty the water tank when the steam cleaner is not in use.
- Never fill the tank with anything other than water. Never put additives (such as perfume, stain remover or products containing alcohol) in the water as they may damage the steam cleaner or make it dangerous to use.
- Always remove the power cord from the outlet and handle the steam cleaner with care when filling with water.
- Do not overfill the tank. Do not exceed the maximum prescribed filling level. Please use the funnel included.
- Ensure that the water tank's closure cap has been screwed down fully before use.

Safety

General Warnings

**IMPORTANT SAFETY INSTRUCTIONS!**

- Do not touch any hot areas on the steam cleaner. It is normal for the steam cleaner to heat up during operation.
- Do not use the steam cleaner to treat any item of clothing while being worn on the body.
- The force and heat of the steam may have an adverse effect on some materials. Always test the steamer on a small concealed area to determine if it is suitable for treatment with the steam cleaner.
- Never aim the steam cleaner at people, animals or plants (risk of scalding!) Do not aim the steam cleaner at electrical systems or wires.
- Accessories become hot during use - allow them to cool down before handling.
- Do not use the steam cleaner directly overhead.

IMPORTANT! This steam cleaner is equipped with a steam release valve mechanism, located at the rear of the steam generator. In the event of a steam flow blockage, the safety valve is designed to release the steam. Regular cleaning of the steam chamber and nozzle is therefore recommended to avoid such an occurrence. If the steam is released from the safety valve, stop cleaning and unplug the steam cleaner from the electrical outlet. Allow the steam cleaner to cool down thoroughly for at least one hour. After this time, clean the steam chamber and nozzle.

If steam is still being released from the safety valve after cleaning, contact a service center.

SAVE THESE INSTRUCTIONS
Household Use Only

Parts

Product Components & Accessories

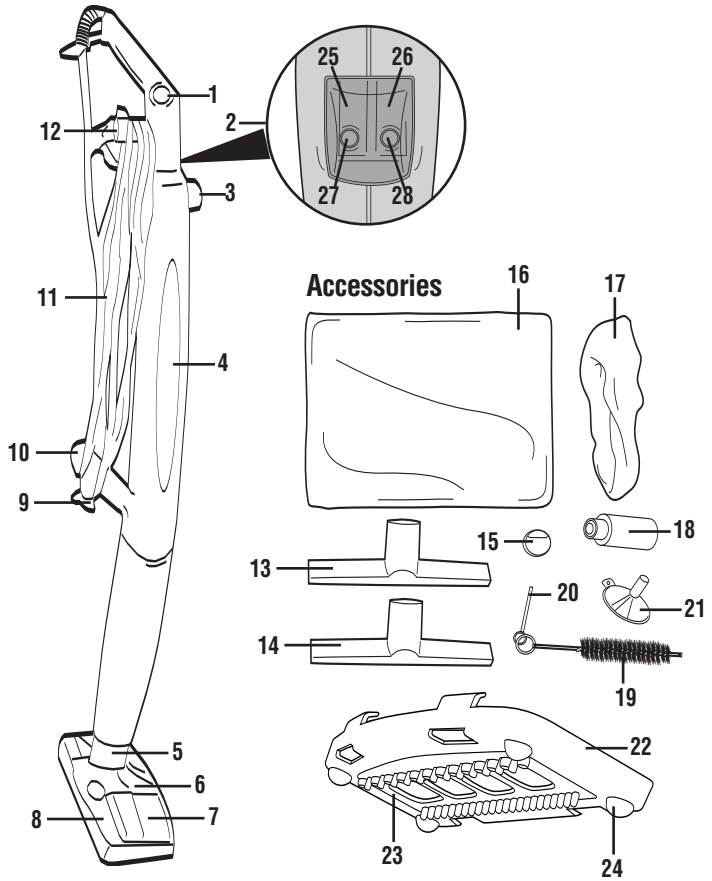

Parts

- | | | |
|--------------------|----------------------|----------------------|
| 1 Steam Regulator | 12 Cord Dump | 23 Steam Comb |
| 2 Control Switches | 13 Squeegee | 24 Corner Gliders |
| 3 Water Tank Cap | 14 Utility Tool | 25 On/Off Switch |
| 4 Water Tank | 15 Deflector Nozzle | 26 Steam Switch |
| 5 Lock Button | 16 Floor Cloth | 27 Power ON Light |
| 6 Powerhead | 17 Utility Cloth | (red) |
| 7 Towel Grips | 18 Spot Brush | 28 Steam Ready Light |
| 8 Brush Slides | 19 Nozzle Brush | (green) |
| 9 Cord Wrap | 20 Nozzle Pin | |
| 10 Lower Handle | 21 Funnel | |
| 11 Power Cord | 22 Carpet Glide Base | |

Operation

Operating Instructions

1. Place the steam cleaner in a horizontal position and remove the water tank cap. Use the funnel provided to slowly fill the 1 liter water tank with clean water. Replace the cap securely.
2. Insert the power plug into an electrical outlet. Make sure the steam cleaner is switched off.
3. Press the ON/OFF switch located on the handle to switch the steam cleaner on. The red heater "ON" light should now be illuminated.
4. Press the steam switch to the "ON" position. After approximately 30 seconds the green "steam ready" light should come on.
5. Turn the steam regulator control to maximum and point the steam nozzle towards a cloth or sink for approximately 10 - 15 seconds, to stabilize the flow and produce a continuous steam.

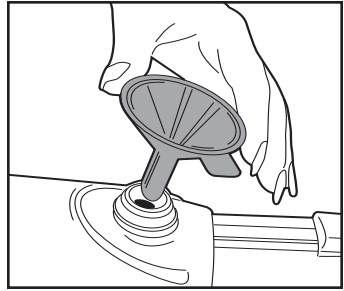

NOTE: Ensure the steam switch is turned off and the powerhead has cooled before connecting the powerhead or any of the other cleaning accessories.

Using the Steam-It™

NOTE: Carpets should be dry and vacuumed thoroughly before using the steam cleaner.

1. Align the hole in the side of the powerhead with the lock button on the main body of the steam cleaner. Ensure that the lock button clicks firmly into place.
2. After assembling powerhead, connect the floor cloth to the powerhead by using the towel grips.
3. Turn the steam switch on.

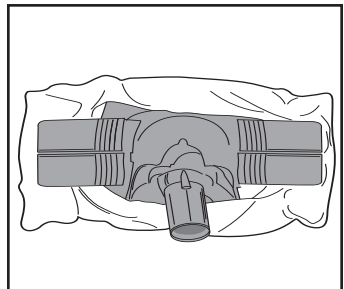
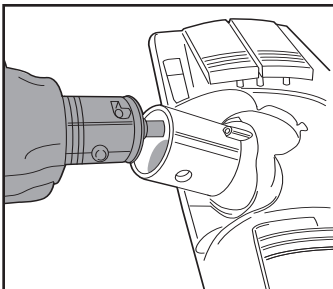

Operation

Cleaning Surface/Steam Setting Reference

Cleaning Surface	Steam Regulator Setting
Carpet & Rugs	Maximum (High)
Glass & Mirrors	Minimum (Low)
Grout on Hard Surfaces	Medium to High
Tiled Surfaces, Cabinets & Countertops in Kitchens & Bathrooms	Low to Medium
Sealed Hardwood	Low

Carpet Cleaning

When cleaning carpets and rugs, leave the steam regulator control set to “maximum.” Always test the steamer on a small surface area to determine if it is suitable for treatment with the steam cleaner. Use slow backward strokes and lift the powerhead slightly during forward strokes to reduce friction between the cloth and the carpet.

For Large Carpeted Areas

For smoother movement of the steamer over larger carpeted areas the carpet glide attachment can be used:

1. Detach and remove the steam comb section from the carpet glide attachment.
2. Fold the cloth and place inside the carpet glide base.
3. Secure the powerhead inside the carpet glide base and connect the cloth to the attachment by using the towel grips.

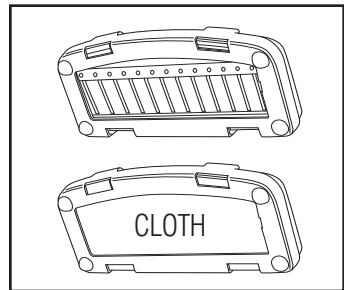

NOTE: On flat pile carpet unscrew and remove the corner gliders.

Operation

Stubborn Stains

For removing stubborn stains or embedded grime on hard surfaces, fold and attach the cloth leaving the brushes underneath the powerhead visible.

Move the brush sliders so that the brushes appear underneath the powerhead. Move the brushes backwards and forwards over the selected area.

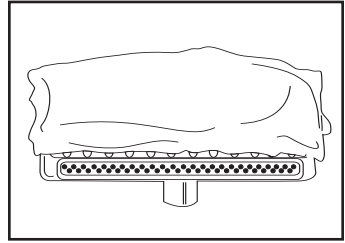

NOTE: Do not use the brushes for routine carpet and hard floor cleaning as unnecessary scrubbing may cause damage. The brushes should only be used for removing stubborn stains and grime.

Carpet Pile Rejuvenation

To rejuvenate flattened carpet pile, remove the cloth and connect the carpet glide base to the powerhead with the steam comb section in place.

IMPORTANT! The housing and accessories become hot during operation. Allow the steam cleaner to cool down before changing the accessories. Never open the water tank cap while the steam switch is on.

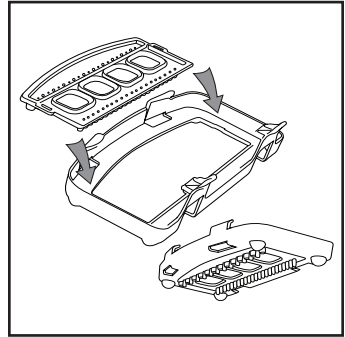

Hard Floor Cleaning

Reduce the steam flow to a lower setting by turning the steam control regulator. Use both forward and backward strokes across the floor area.

NOTE: When the cloth becomes very wet, let cool, ring out the moisture, use the reverse side or replace with a clean, dry cloth.

Attaching an Accessory

Accessories can be used on the main body of the steam cleaner by removing the powerhead and then attaching the desired accessory.

1. Press the lock button to remove the powerhead when cool.
2. Attach the desired accessory by aligning the hole in the side of the accessory with the lock button on the main body of the steam cleaner. Ensure the lock button clicks firmly into place.

Operation

Squeegee

For cleaning glass and mirror panels. Use the squeegee at a very low steam flow. Achieve this by adjusting the steam regulator. A cloth can be used to wipe the blade and remove excess water during usage when cool. For small window panels, remove the squeegee tool and spray the steam directly onto the surface. Use the squeegee separately to wipe away the moisture.

Spot Brush

For cleaning the grout between tiles or stubborn marks and stains on hard surfaces. Use at medium or high steam flow.

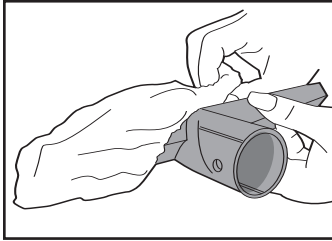

Utility Tool

For cleaning tiled surfaces, cabinets and countertops in kitchens and bathrooms. Use on a low to medium steam flow. Cover the utility tool with the elasticised cloth.

Deflector Nozzle

For cleaning sanitary ware such as toilet bowls, taps or drain covers. Use this nozzle at maximum steam flow. Point it directly at stains on carpets or upholstery while holding a clean cloth near the stained area to capture any loosened dirt.

Maintenance

After Each Use

NOTE: When you have finished steam cleaning, ensure that both the power switch and steam switch are turned off and that the plug is removed from the electrical outlet.

Let the unit cool and then empty any remaining water from the tank by unscrewing the water tank cap and turning the steam cleaner upside down over a sink or outdoors.

Store the steam cleaner by using the hanging strap at the top of the handle if needed.

Cleaning the Steam Generator

IMPORTANT! Only follow these instructions when the steam cleaner is completely cooled down. Also ensure that the plug is removed from the electrical outlet.

1. Twist the steam nozzle, releasing it from its locked position. Pull upwards; this will remove it completely from the steam chamber.
2. Insert the nozzle brush into the chamber.
3. Rotate the brush while pulling it in and out of the chamber.
4. Insert the steam nozzle back into the chamber and turn it clockwise to lock back into position.

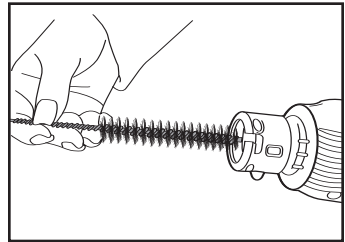
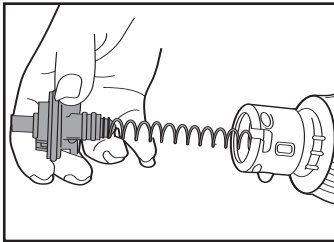

NOTE: Oreck recommends cleaning the chamber at least after every 12 - 15 uses to ensure optimum performance.

Unblocking the Steam Outlet

If steam flow appears reduced, the steam nozzle may be blocked. Unplug the unit from the electrical outlet and allow it to cool.

1. Insert the nozzle pin into the center of the steam nozzle to clear any blockage that may have formed.

Cleaning the Cloths

Both the floor and utility cloths can be machine washed (60°C max). For heavy soiling, soak the cloths in warm water and detergent or a mild stain remover. Allow the cloths to dry completely before storing.

Trouble-shooting

If the following troubleshooting tips do not resolve the problem please contact Oreck Customer Service. U.S.: 1-800-989-3535 Canada: 1-888-676-7325

IMPORTANT! Always unplug and allow the steam cleaner to cool down before conducting any troubleshooting. See safety warnings.

Problem	Cause	Solution
Steam Cleaner has no power	<p>Steam cleaner is not properly plugged into an electrical outlet or is not switched on.</p> <p>The socket is faulty.</p>	<p>Insert the plug into an electrical outlet and switch the steam cleaner on.</p> <p>Check the socket by unplugging the steam cleaner and plugging in a different appliance.</p>
No steam is emitted when the steam cleaner is on.	<p>The power cable is damaged.</p> <p>The water tank is empty.</p> <p>The steam nozzle is blocked.</p> <p>Despite the green light, the steam switch is not activated properly</p> <p>The weighted tube inside the tank is not in the correct (immersed) position.</p>	<p>Contact Oreck for Service.</p> <p>Fill the water tank.</p> <p>See <i>“Unblocking the Steam Outlet”</i></p> <p>Press down the steam switch fully.</p> <p>Shake the steam cleaner gently.</p>
Only a very small amount of steam flows out of the steam cleaner.	<p>The steam regulator is set to minimum.</p>	<p>Turn the steam controller until sufficient steam is emitted.</p>
Unit still does not operate properly.	<p>Check all the above points.</p>	<p>Contact Oreck for service.</p>

Warranty

ORECK MANUFACTURING COMPANY: (Oreck gives you the following limited warranty for this product only if it was originally purchased for use, not resale, from Oreck or an Oreck Authorized Retail Dealer.)

Oreck will repair or replace, free of charge, to the original purchaser, any part which is found to be defective in material or workmanship within one (1) year of the date of purchase. This limited warranty applies to normal domestic use.

This limited warranty does not cover the replacement of expendable or consumable parts such as belts, brushes, bulbs, batteries and other parts subject to normal wear.

This limited warranty does not apply to any part subjected to accident, abuse, commercial use, alteration, misuse, damage caused by fire or act of God, the use of voltages other than indicated on the serial number plate of this product or service of this product by other than Oreck or an Oreck Factory Authorized Service Center.

Oreck does not authorize any person or representative to assume or grant any other warranty obligation with the sale of this product.

Oreck's limited warranty is valid only if you retain proof of purchase from Oreck or an Oreck Authorized Retail Dealer for this product. If you purchase this product from any other source, your purchase is "AS IS," which means Oreck grants you no warranty, and that you, not Oreck, assume the entire risk of the quality and performance of this product, including the entire cost of any necessary servicing or repairs of any defects.

ORECK'S LIABILITY FOR DAMAGES TO YOU FOR ANY COSTS WHATSOEVER ARISING OUT OF THIS STATEMENT OF LIMITED WARRANTY SHALL BE LIMITED TO THE AMOUNT PAID FOR THIS PRODUCT AT THE TIME OF ORIGINAL PURCHASE, AND ORECK SHALL NOT BE LIABLE FOR ANY DIRECT, INDIRECT, CONSEQUENTIAL OR INCIDENTAL DAMAGES ARISING OUT OF THE USE OR INABILITY TO USE THIS PRODUCT.

Some states do not allow the exclusion or limitation of incidental or consequential damages, so the above limitation or exclusion may not apply to you.

ALL EXPRESS AND IMPLIED WARRANTIES FOR THIS PRODUCT, INCLUDING IMPLIED WARRANTIES OF MERCHANTABILITY AND FITNESS FOR A PARTICULAR PURPOSE, ARE LIMITED IN DURATION TO THE WARRANTY PERIOD, AND NO WARRANTIES, WHETHER EXPRESS OR IMPLIED, WILL APPLY AFTER THIS PERIOD.

Some states do not allow limitations on the duration of implied warranties, so the above limitation may not apply to you.