



POWERWARE® 3110

300–700 VA

User's Guide

www.powerware.com

Class B EMC Statements

FCC Part 15

NOTE This equipment has been tested and found to comply with the limits for a Class B digital device, pursuant to part 15 of the FCC Rules. These limits are designed to provide reasonable protection against harmful interference in a residential installation. This equipment generates, uses and can radiate radio frequency energy and, if not installed and used in accordance with the instructions, may cause harmful interference to radio communications. However, there is no guarantee that interference will not occur in a particular installation. If this equipment does cause harmful interference to radio or television reception, which can be determined by turning the equipment off and on, the user is encouraged to try to correct the interference by one or more of the following measures:

- Reorient or relocate the receiving antenna.
- Increase the separation between the equipment and the receiver.
- Connect the equipment into an outlet on a circuit different from that to which the receiver is connected.
- Consult the dealer or an experienced radio/TV technician for help.

ICES-003

This Class B Interference Causing Equipment meets all requirements of the Canadian Interference Causing Equipment Regulations ICES-003.

Cet appareil numérique de la classe B respecte toutes les exigences du Règlement sur le matériel brouilleur du Canada.

Requesting a Declaration of Conformity

Units that are labeled with a CE mark comply with the following harmonized standards and EU directives:

- Harmonized Standards: EN 50091-1-1 and EN 50091-2
- EU Directives: 73/23/EEC, Council Directive on equipment designed for use within certain voltage limits
93/68/EEC, Amending Directive 73/23/EEC
89/336/EEC, Council Directive relating to electromagnetic compatibility
92/31/EEC, Amending Directive 89/336/EEC relating to EMC

The EC Declaration of Conformity is available upon request for products with a CE mark. For copies of the EC Declaration of Conformity, contact:

Powerware Corporation
Koskelontie 13
FIN-02920 Espoo
Finland
Phone: +358-9-452 661
Fax: +358-9-452 665 68

Powerware is a registered trademark of Powerware Corporation.

©Copyright 2001-2003 Powerware Corporation, Raleigh, NC, USA. All rights reserved. No part of this document may be reproduced in any way without the express written approval of Powerware Corporation.



TABLE OF CONTENTS

1	Installation	1
	Inspecting the Equipment	1
	Safety Precautions	1
	Quick Startup	2
	UPS Top and Side Panels	3
2	Features	5
	Communication Options	5
	USB Port	5
	DB-9 Communication Port	6
	Battery Start Feature	7
	RJ-11 or RJ-45 Surge Protectors	7
3	UPS Maintenance	9
	UPS and Battery Care	9
	Storing the UPS	9
	Replacing Batteries	9
	Recycling the Used Battery	11
4	Specifications	13
5	Troubleshooting	15
	Service and Support	16



CHAPTER 1

INSTALLATION

This section explains:

- Equipment inspection
- Safety precautions
- UPS installation
- UPS top and side panels

Inspecting the Equipment

If any equipment has been damaged during shipment, keep the shipping cartons and packing materials for the carrier or place of purchase and file a claim for shipping damage. If you discover damage after acceptance, file a claim for concealed damage.

To file a claim for shipping damage or concealed damage: 1) File with the carrier within 15 days of receipt of the equipment; 2) Send a copy of the damage claim within 15 days to your service representative.

Safety Precautions

Read the following precautions before you install the UPS.

IMPORTANT SAFETY INSTRUCTIONS

SAVE THESE INSTRUCTIONS. This manual contains important instructions that you should follow during installation and maintenance of the UPS and batteries. Please read all instructions before operating the equipment and save this manual for future reference.

WARNING



- This UPS contains its own energy source (batteries). The output receptacles may carry live voltage even when the UPS is not connected to an AC supply.
- Do not remove or unplug the input cord when the UPS is turned on. This removes the safety ground from the UPS and the equipment connected to the UPS.

- To reduce the risk of fire or electric shock, install this UPS in a temperature and humidity controlled, indoor environment, free of conductive contaminants. Ambient temperature must not exceed 40°C (104°F). Do not operate near water or excessive humidity (95% max).
- With the exception of the user-replaceable battery, all servicing of this equipment must be performed by qualified service personnel.
- Before maintenance or repair, all connections must be removed. Before maintenance, repair, or shipment, the unit must be completely switched off and unplugged or disconnected.

CAUTION



- **Important Notice** The UPS ground (earth) conductor carries leakage current from the loads in addition to any leakage current generated by the UPS. This UPS generates no more than 0.5 mA of current (120V model), or 1 mA of current (230V model).
- To limit the total leakage current to 3.5 mA, the load leakage must be limited to 3 mA on the 120V model and 2.5 mA on the 230V model.
- If you do not know the load leakage current, replace the UPS power cord (230V model only) with a power cord that uses a locking plug with a minimum rating of 10A (such as IEC 309).
- If you do not have a matching receptacle, consult an electrician to install the proper receptacle.
- The three-wire receptacle that you plug the UPS into must have a good (low-impedance) ground (protective earth) connection to provide a safe path for leakage current.

Quick Startup

The Powerware® 3110 provides protection against many power problems, including power outages. It also provides spike suppression and line noise filtering to protect your equipment.

1. On 230V models, plug the UPS power cord into the input connector on the UPS side panel.
2. Plug the equipment to be protected into the UPS output receptacles.

DO NOT protect laser printers with the UPS because of the exceptionally high power requirements of the heating elements.

3. Start the UPS by pressing the | switch as shown in Figure 2 or Figure 4 on page 4. The ~ indicator illuminates indicating that power is available from the UPS output receptacles.

The unit beeps and the front panel LEDs illuminate several times. The ~ indicator remains on, indicating normal operation.

If the unit continues to beep, or if the ~ indicator is off even though input power is available from the wall outlet, see “Troubleshooting” on page 15.



NOTE Let the unit charge the battery for at least 3 hours. You may use the unit while the battery charges, but the battery backup runtime will be reduced until the battery is fully charged. This will take up to 8 hours after a full discharge while the UPS is fully loaded.

UPS Top and Side Panels

Figure 1 and Figure 2 identify features of the 120V (USA) models, with attached input line cord. Figure 3 and Figure 4 identify features of the 230V (European) models, which have a connector for the input line cord as well as IEC output receptacles.

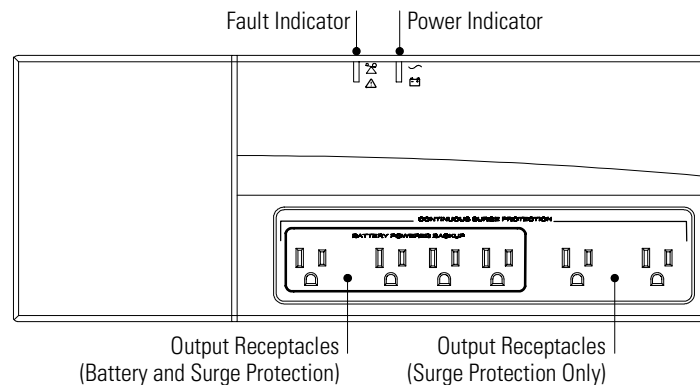

Figure 1. 120V Model Top Panel

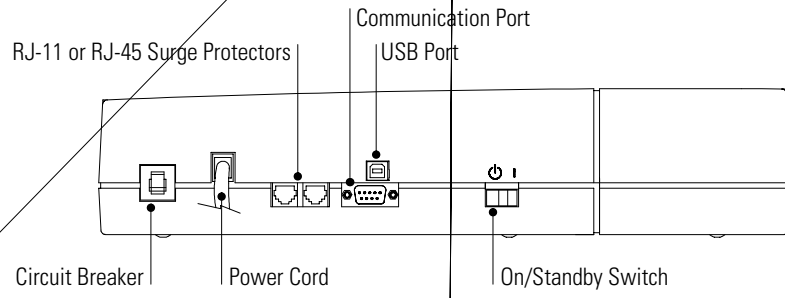
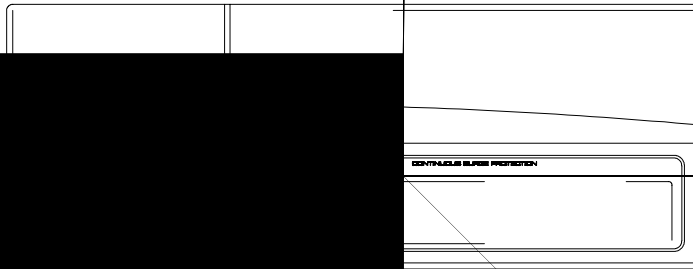

Figure 2. 120V Model Side Panel





CHAPTER 2

FEATURES

This section covers:

- Using the USB or DB-9 communication port
- Starting the UPS on battery

Communication Options

The UPS is equipped with a USB and a DB-9 communication port. Either the USB port or the DB-9 communication port may be used to monitor the UPS; however, they cannot operate simultaneously.

USB Port

The UPS can communicate with a USB-compliant computer using LanSafe Power Management Software (v4.15 or higher).

To establish communication between the UPS and a computer:

1. Connect the USB cable to the USB port on the UPS rear panel.
Connect the other end of the USB cable to the USB port on your computer.
2. Install the LanSafe software and USB drivers according to the instructions provided with the Powerware Software Suite CD.

DB-9 Communication Port

Powerware offers an accessory interface kit that allows you to connect many types of computer systems to the UPS communication port. For specific information on Powerware interface kits, call your service representative.

Contacts consist of open collector circuits capable of switching up to +30 Vdc, 6 mA resistive load.

Table 1. Communication Port Pin Assignment

Pin	Signal Type	Function
1	RS-232 Level Shutdown	+12 Vdc signal held for 5 seconds on this pin shuts the UPS down 120 seconds later. The UPS restarts after 15 seconds when utility power returns.
2	Not Used	Not Used
3	Normally Open On-Battery Contact	A normally open contact that closes 15 seconds (pulls to Common) after the UPS switches to battery power.
4	Common	The signal ground for all signal pins.
5	Normally Open Low-Battery-Alarm Contact	A normally open contact that closes (pulls to Common) during a Low Battery Alarm.
6	Normally Closed Low-Battery-Alarm Contact	A normally closed contact that opens (releases from Common) during a Low Battery Alarm. This tells some shutdown software when to start a computer shutdown.
7	Not Used	Not Used
8	Normally Closed On-Battery Contact	A normally closed contact that opens 15 seconds (releases from Common) after the UPS switches to battery power.
9	Not Used	Not Used

Battery Start Feature

The Battery Start feature allows you to turn on the UPS when utility power is not available. The battery-start range is up to about 40% of nominal input; otherwise, the UPS displays an input voltage fault and the alarm beeps.

RJ-11 or RJ-45 Surge Protectors

The RJ-11 or RJ-45 surge protectors are located on the side panel and are labeled IN and OUT. This feature accommodates an RJ-11 connector that provides protection for modems, fax machines, or other telecommunications equipment. As with most modem equipment, it is not advisable to use this jack in digital PBX (Private Branch Exchange) environments.

Low voltage models can also accommodate a single RJ-45 (10BaseT) network connector.



NOTE DO NOT connect any network equipment to the 230V models; only telephone or fax/modem protection is available for 230V models.

1. Connect the input connector of the equipment you are protecting to the jack labeled IN.
2. Connect the output connector to the jack labeled OUT.



CHAPTER 3

UPS MAINTENANCE

This section explains how to:

- Care for the UPS and batteries
- Replace the batteries
- Recycle used batteries

UPS and Battery Care

For the best preventive maintenance, keep the area around the UPS clean and dust-free. If the atmosphere is very dusty, clean the outside of the system with a vacuum cleaner.

For full battery life, keep the UPS at an ambient temperature of 25°C (77°F).

Storing the UPS

If you store the UPS for a long period, recharge the battery every 6 months by plugging the UPS into a power outlet.

Replacing Batteries

Before replacing the battery, make sure that you read the safety information below.



WARNING

- Batteries can present a risk of electrical shock or burn from high short circuit current. The following precautions should be observed: 1) Remove watches, rings, or other metal objects; 2) Use tools with insulated handles; 3) Do not lay tools or metal parts on top of batteries.
- **ELECTRIC ENERGY HAZARD.** Do not attempt to alter any battery wiring or connectors. Attempting to alter wiring can cause injury.
- Replace batteries with the same number and type of batteries as originally installed in the UPS.
- **DO NOT DISCONNECT** the batteries while the UPS is in Battery mode.



CAUTION

The 230V models require replacement by qualified service personnel.

1. Contact your service representative to order a replacement battery. It must be the same type and rating as the original battery (see Table 3 on page 14).
2. Switch off and unplug the protected equipment from the UPS.
3. Turn off the UPS and disconnect the power cord.
4. Turn the UPS upside down.

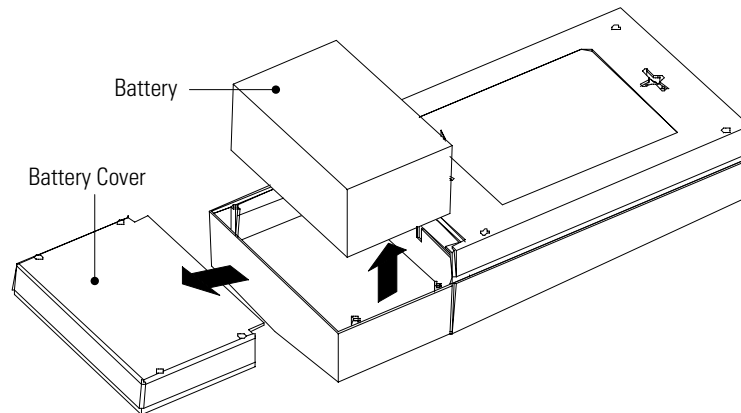

Figure 5. Removing the Battery Cover and Battery

5. Remove the battery cover:
 - Models 550 and 700** –Use a screwdriver to remove the four screws securing the battery cover and lift the battery cover off.
 - Model 300** –Press down on the battery cover tabs and slide the battery cover off.
6. Lift the battery up and out of the case.
7. Disconnect the red and black cables from the used battery.
8. Replace the battery. See “Recycling the Used Battery” for proper disposal.
9. Reconnect the cables to the new battery; red to positive (+), black to negative (–), and slide the battery back into the case.

10. Replace the battery cover by pushing the cover until it snaps into place securely. Replace any battery cover screws that were removed to access the battery.
11. Turn the UPS right side up. Reconnect the UPS power cord and turn the unit on.
12. Reconnect the equipment. Switch on the protected equipment one piece at a time.

Recycling the Used Battery

Contact your local recycling or hazardous waste center for information on proper disposal of the used battery.



WARNING

- Do not dispose of the battery or batteries in a fire. Batteries may explode. Proper disposal of batteries is required. Refer to your local codes for disposal requirements.
- Do not open or mutilate the battery or batteries. Released electrolyte is harmful to the skin and eyes. It may be toxic.



CAUTION

Do not discard the UPS or the UPS batteries in the trash. This product contains sealed, lead-acid batteries and must be disposed of properly. For more information, contact your local recycling or hazardous waste center.



CHAPTER 4

SPECIFICATIONS

Powerware Corporation reserves the right to change specifications without prior notice.

Table 2. Electrical

	120V Model	230V Model
Nominal Voltage	120V	230V
Power Factor	0.6	
Voltage Range	Online: 90-152V On Battery: 0-100V and 152-160V	Online: 176-272V On Battery: 0-192V and 272-290V
Nominal Frequency	50/60 Hz auto-sensing 57-63 Hz (60 Hz) 47-53 Hz (50 Hz)	
Efficiency (Normal mode)	> 95%	
Noise Filtering	Full-time EMI/RFI filtering	
Overcurrent Protection	Resettable circuit breaker	
Connections	Attached 5-15P power cord	IEC 320-C14 input connector Input fault current: 15A maximum
Power Levels (rated at nominal inputs)	PW3110 300: 300 VA, 180W PW3110 550: 550 VA, 330W PW3110 700: 700 VA, 420W	PW3110 300i: 300 VA, 180W PW3110 550i: 550 VA, 330W PW3110 700i: 700 VA, 420W
Total Output Current	10A maximum	
Load Compatibility	Switch-mode power supply or resistive load	
Output Frequency (Battery mode)	50/60 Hz \pm 1 Hz of nominal frequency	
Connections	(4) 5-15 receptacles with UPS and surge protection (2) 5-15 receptacles with surge protection only	(4) IEC 320-C13 receptacles with UPS and surge protection (2) IEC 320-C13 receptacles with surge protection only

Table 3. Battery

Configuration	300 VA: (1) 12V, 4.2 Ah or (2) 6V, 4.0 Ah internal battery(s) 550 VA: (1) 12V, 7.0 or 7.2 Ah internal battery 700 VA: (1) 12V, 9 Ah internal battery
Voltage	12 Vdc
Type	Sealed, maintenance-free, valve-regulated, lead-acid
Charging	8 hours to 95% capacity with output fully loaded
Monitoring	Advanced monitoring for earlier failure detection and warning
Backup Time	300–550 VA: 3 minutes at full load; 5 minutes typical load 700 VA: 2.5 minutes at full load; 5 minutes typical load
Transfer Time	4 ms typical

Table 4. Weights and Dimensions

UPS Dimensions (HxWxD)	300 VA: 5.9 x 39.3 x 15.0 cm (2.3" x 15.5" x 5.9") 550–700 VA: 7.9 x 37.6 x 17.2 cm (3.1" x 14.8" x 6.8")
UPS Weight	300 VA: 3.0 kg (6.6 lb) 550 VA: 4.2 kg (9.2 lb) 700 VA: 4.3 kg (9.4 lb)

Table 5. Environmental and Safety

	120V Model	230V Model
Operating Temperature	0°C to 40°C (32°F to 104°F)	
Storage Temperature	-15°C to 50°C (-5°F to 122°F) If the UPS is stored, the batteries should be recharged every 6 months. If stored above 25°C (77°F), battery life is reduced and should be recharged more often.	
Ventilation	Air around the unit must be free of dust, chemicals, or other materials that corrode or contaminate.	
Relative Humidity	5–95% RH noncondensing	
Audible Noise	Online: Less than 40 dBA typical at one meter On Battery: Less than 45 dBA typical at one meter	
Surge Energy Rating	450 joules	
Surge Suppression	ANSI C62.41 Category A (formerly IEEE 587)	IEC 61000-4-5, Level 3
Safety Conformance	UL 1778; UL 497A; CAN/CSA C22.2, No. 107.1	EN 50091-1-1 and EN 60950
Safety Markings	UL, cUL	NEMKO, CE
EMC (Class B)	FCC Part 15, ICES-003	EN 50091-2









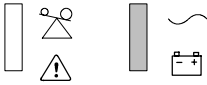
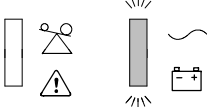
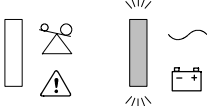
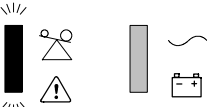
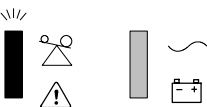

CHAPTER 5

TROUBLESHOOTING

The front panel LEDs and an audible beep indicate the UPS status (see Table 6). The UPS beeps whenever the unit is on battery power or an alarm is present.

Table 6. Troubleshooting

Alarm or Condition	Possible Cause	What to Do
	Normal operation.	None. The UPS is operating in Normal mode.
	Line loss due to: <ul style="list-style-type: none"> Utility power outage. Loose plug connection. Tripped circuit breaker. Power cord failure. 	<ul style="list-style-type: none"> Wait for utility power to return. Check the power cord connections. Reset the circuit breaker. Contact your service representative for a new power cord.
1 beep every 5 seconds.		
	Low battery alarm; shutdown is imminent.	Prepare for a UPS shutdown. Save your work and turn off your equipment. The unit automatically restarts when acceptable power returns.
2 beeps every 5 seconds.		
	The battery needs charging or service.	Turn the UPS off and plug the UPS into a power outlet for 24 hours to charge the battery. Turn the UPS on to test the battery. If the alarm still beeps, see "Replacing Batteries" on page 9 to replace the battery.
3 beeps every 5 seconds.		
	The battery is discharged and battery power is not available.	The UPS automatically recharges the battery. The alarm clears when the battery is recharged. NOTE If the UPS has not recharged the battery after 24 hours, the alarm changes to 3 beeps every 5 seconds and the battery must be replaced. See "Replacing Batteries" on page 9 to replace the battery.
3 beeps every 5 minutes.		

Alarm or Condition	Possible Cause	What to Do
    	Power requirements exceed the UPS capacity.	Remove some of the equipment from the UPS. You may need to obtain a larger capacity UPS.
1 beep every half second.		
    	Output short circuit. Input voltage is out of range when the UPS is turned on.	Turn off or unplug the equipment connected to the UPS. Turn off the UPS until acceptable input voltage restored.
Continuous beep.	UPS fault.	Contact your service representative.

Service and Support

If you have any questions or problems with the UPS, call your **Local Distributor** or the **Help Desk** at one of the following telephone numbers and ask for a UPS technical representative.

In the United States: **1-800-356-5737** or **1-608-565-2100**
 Europe, Middle East, Africa: **+44-17 53 608 700**
 Asia: **+852-2830-3030**
 Australia: **+61-3-9706-5022**

Please have the following information ready when you call the Help Desk:

- Model number
- Serial number
- Version number (if available)
- Date of failure or problem
- Symptoms of failure or problem
- Customer return address and contact information

If repair is required, you will be given a Returned Material Authorization
