

Electric Stand Mixer

USE AND CARE GUIDE
MODEL TMSM350



IMPORTANT SAFEGUARDS

When using electrical appliances, basic safety precautions should always be followed, including the following:

- ◆ Read all instructions.
- ◆ To protect against risk of electrical shock, do not put cord, plugs or appliance in water or other liquid.
- ◆ Close supervision is necessary when any appliance is used by or near children.
- ◆ Unplug from outlet when not in use, before putting on or taking off parts, and before cleaning.
- ◆ Avoid contacting moving parts.
- ◆ Do not operate any appliance with a damaged cord or plug or after the appliance malfunctions, or is dropped or damaged in any manner. Contact Consumer Service.
- ◆ The use of accessory attachments not recommended or sold by the manufacturer may cause fire, electrical shock or injury.
- ◆ Do not use outdoors.
- ◆ Do not let cord hang over edge of table or counter.
- ◆ Do not let cord contact hot surface, including the stove.
- ◆ Keep hands, hair, clothing, as well as spatulas and other utensils away from Beaters during operation to reduce the risk of injury to persons, and/or damage to the Mixer.
- ◆ Remove Beaters from Mixer before washing.

SAVE THESE INSTRUCTIONS

For Household Use Only



ADDITIONAL IMPORTANT SAFEGUARDS

- ◆ All users of this appliance must read and understand this Use and Care Guide before operating or cleaning this appliance.
- ◆ The cord to this appliance should be plugged into a 120V AC electrical outlet only.
- ◆ Do not leave this appliance unattended during use.
- ◆ If this appliance begins to malfunction during use, immediately turn the unit OFF and unplug the cord. Do not use or attempt to repair the malfunctioning appliance.
- ◆ If this appliance falls or accidentally becomes immersed in water, unplug it immediately. **Do not reach into the water!** Do not use this appliance after it has fallen into or becomes immersed in water.
- ◆ To reduce the risk of injury to persons or property, never use this appliance in an unstable position.
- ◆ Do not use this appliance for other than its intended use.

POLARIZED PLUG

Model TMSM350 has a polarized plug, (one blade is wider than the other). To reduce the risk of electrical shock, this plug is intended to fit into a polarized outlet only one way. If the plug does not fit fully in the outlet, reverse the plug. If it still does not fit, contact a qualified electrician. Do not attempt to modify the plug in any way.

SHORT CORD INSTRUCTIONS

A short power-supply cord is provided to reduce the risk resulting from becoming entangled in or tripping over a longer cord.

Do not use an extension cord with this product.

ELECTRIC POWER

If the electrical circuit is overloaded with other appliances, your appliance may not operate properly. It should be operated on a separate electrical circuit from other appliances.

Getting to know your **Toastmaster** Electronic Stand Mixer

Your product may vary slightly from illustration.

FIGURE 1

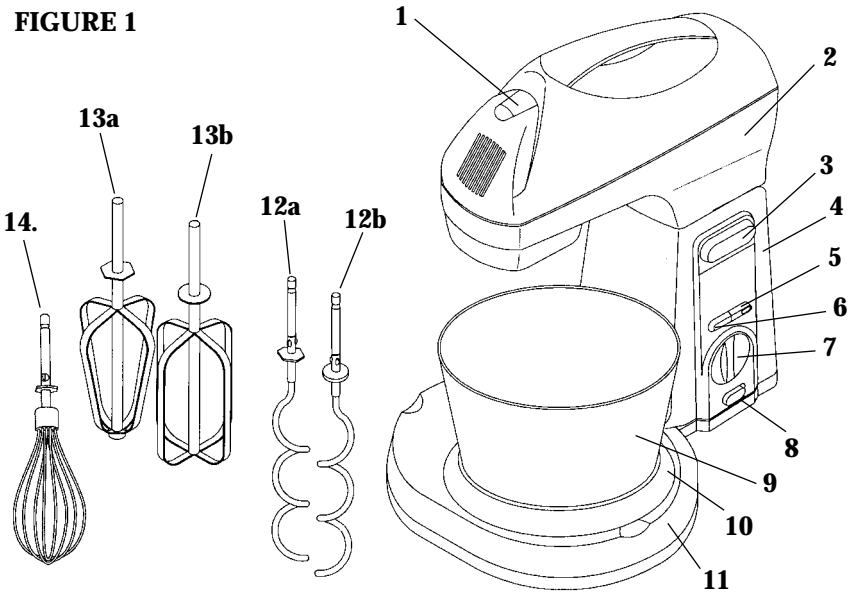

- 1. Eject Button
- 2. Mixer Head
- 3. Release Button
- 4. Mixer Body
- 5. Power Light
- 6. Turbo Button
- 7. Variable Speed Control
- 8. ON/OFF Power Switch
- 9. 4-Quart Stainless-Steel Mixing Bowl (P/N 70510)
- 10. Turntable (P/N 70512)
- 11. Base

- 12. a) Dough Hook with Hexagonal Collar (P/N 70506)
- b) Dough Hook with Round Collar (P/N 70517)
- 13. a) Round Beater with Hexagonal Collar (P/N 70509)
- b) Square Beater with Round Collar (P/N 70508)
- 14. Balloon Wire Whisk (P/N 70820)



FIGURE 2



FIGURE 3

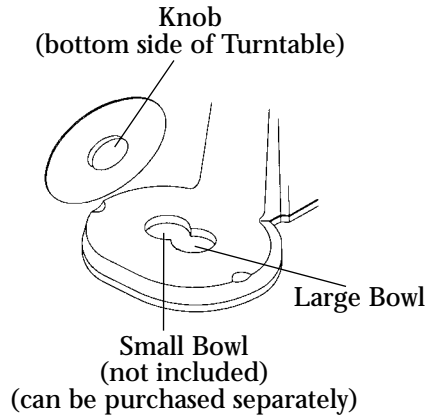

FIGURE 4

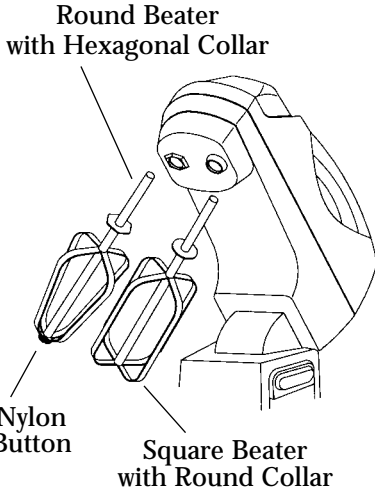

FIGURE 5

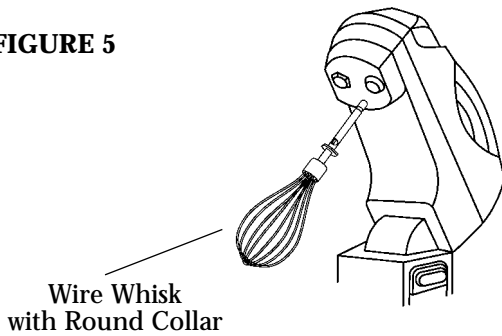
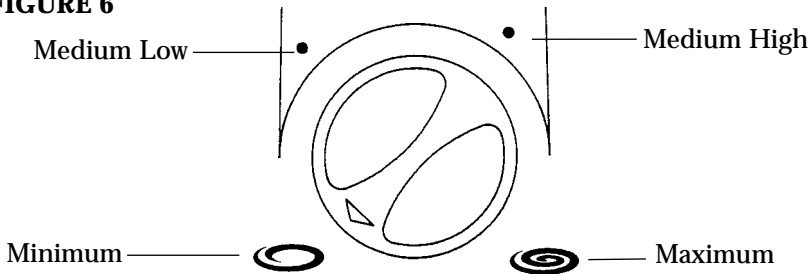

FIGURE 6



Before Using Your Electronic Stand Mixer

Carefully unpack the Mixer and remove all packaging materials. Wipe unit with damp cloth to remove any dust that may have accumulated, wash the Beaters, Dough Hooks, Whisk and Bowl in warm soapy water. Rinse and dry thoroughly.

Read all instructions carefully before using your Stand Mixer. We recommend that you become familiar with this appliance and its attachments before using, see Figures 1-5.





The maximum capacity of the Stainless-Steel Mixing Bowl is 4 quarts.

Use Of Attachments

| | |
|-------------|---|
| Beaters | Use for blending and beating mixes. |
| Dough Hooks | Use for dough, pie crust, pasta dough and blending large amounts of dry ingredients together. |
| Wire Whisk | Use for whipping, egg whites, egg yolks, sauce, souffle, mousse, meringue and salad dressing. |



Mixing Guide

| Icon | Speed | Action | Mixing Procedure |
|---|-----------------|----------------------|--|
|  | Minimum | Stir/Fold | Use when stirring liquid ingredients or when a gentle action is needed to moisten dry ingredients. Use when folding two portions of a recipe together, like beating an egg white into a batter. |
|  | Medium Low | Mix Knead | Use when mixing dry ingredients and liquid ingredients together alternately in a recipe or use when recipe calls for kneading until the dough is a dough ball. |
|  | Medium High | Blend/Beat /Cream | Use when creaming sugar and butter together. |
|  | Maximum | Whip | Use when preparing a frosting from a recipe or a package. Use to whip whipping cream or potatoes. Use when beating egg whites. |
| TURBO | Turbo Button | Burst of Power | Use to obtain the Maximum power level from any speed setting for tough mixing tasks. |

How To Use Your Electronic Stand Mixer

1. Place Stand Mixer on a large stable surface and slide ON/OFF Power Switch to OFF position. Make sure the surface is clean and dry so the feet will hold the unit securely in place.
2. Press and hold the Release Button and pivot the  Mixer Head upwards, see FIGURE 2. When the Mixer Head is securely in position you will hear a click. Do not attempt to pivot the Mixer Head without first pressing the Release Button. This could damage the Mixer.
3. Place Turntable onto Mixer platform by placing knob into the large or small bowl slot opening, depending on which size bowl is being used, see Figure 3.

NOTE: Although the TMSM350 Mixer comes with only a 4-Quart Stainless-Steel bowl, you may purchase a smaller 1 1/2 qt. bowl (P/N 70511) to use with the mixer as well. Contact Consumer Service for purchasing information.

4. Insert stem of the Beater or Dough Hook with the Hexagonal Collar into the hexagonal opening on the underside of the Mixing Head, see FIGURE 4. If using the Wire Whisk, insert stem of Whisk into the round opening on the underside of the Mixing Head, see Figure 5. Turn slightly if needed to lock into place.
5. Insert stem of the Beater or Dough Hook with the round collar into the round opening on the underside of the Mixing Head. Turn slightly if needed to lock into place.



NOTE: The Beater and Dough Hooks must be inserted into the correct opening as they are not interchangeable. It is also necessary to insert the Beater and Dough Hooks with the Hexagonal Collar first. Never use a Beater with a Dough Hook as this may damage the unit and may void your warranty.

6. Place Stainless Steel Mixing Bowl onto the Turntable.
7. With Beaters, Wire Whisk, or Dough Hooks properly in place, grasp handle on Mixer Head, press the Release Button and slowly lower the Mixer Head downward until it locks into place.



How To Use Your Electronic Stand Mixer (cont.)

8. Plug into 120 V ~ 60 Hz outlet. Turn the Variable Speed Control to the  Minimum position. Slide the ON/OFF Power Switch to the ON position. The Power Light will come on.

NOTE: Always start mixing on the Minimum speed. The operating speed increases as the Variable Speed Control is moved from  Minimum to  Maximum speed, see FIGURE 5. Select the desired speed. Refer to mixing guide on page 5 for further information.

9. Turn the Mixer speed to the  Minimum position and the ON/OFF Power Switch to OFF position before attempting to scrape sides or bottom of Stainless Steel Mixing Bowl.

NOTE: DO NOT scrape sides or bottom of Stainless Steel Mixing Bowl while Mixer is in operation.

10. The Turbo Button may be used at any speed setting to obtain the Maximum power lever for tough mixing tasks.
11. Once all ingredients have reached the desired consistency, turn the Variable Speed Control to the  Minimum position and slide the ON/OFF Power Switch to the OFF position. The Power Light will go off.
12. Unplug cord from outlet.
13. Press and hold the Release Button while raising the Mixer Head.
14. Press the Eject Button and remove the Beaters, Wire Whisk or Dough Hooks. Gently scrape excess batter from Beaters or Dough Hooks with a rubber or plastic spatula. Do not strike Beaters or Dough Hooks against Mixing Bowl to remove excess batter. This could damage the Mixer parts.
15. Carefully remove Mixing Bowl from Turntable. Pour ingredients from bowl into desired container. Use only a rubber or plastic spatula to remove batter from Mixing Bowl.

Care And Cleaning

1. Unplug Stand Mixer from outlet.
2. The Mixing Bowl, Beaters Dough Hooks and Wire Whisk may be washed in the dishwasher.
3. Wipe the Stand Mixer and Turntable with a damp cloth. Do not use any abrasive cleaning materials. Never immerse or clean under running water.

Helpful Hints For Bread And Dough

Bread Dough Ball:

Necessary For A Successful Loaf of Bread

The amount of bread flour called for in each recipe is to be used as a guide. We have found it may vary slightly because different climates and seasons result in a wide variety of humidity levels. Watch the dough as you add the last 1 - 1½ cups of flour. A good dough ball should be round, smooth-textured, soft and slightly tacky to the touch. If it does not form a ball and is more like a batter, add flour until it reaches the appropriate consistency.

Mixing & Kneading:

The Gluten Development Stage

Place ingredients in bowl, except last 1 - 1½ cups flour. Use the Dough Hooks at the beginning of the mixing stage to start the gluten development. Then gradually add enough of the remaining flour to make a soft dough. The dough should clean the sides of the bowl and form a soft ball around the Dough Hooks.

When adding wheat bran, wheat germ, bulgur or cracked wheat to a bread recipe, leave the dough as moist as possible, because these ingredients absorb liquid and tend to produce a drier loaf. Reduce the amount of kneading to avoid cutting the gluten strands with the sharp edges of these grains.

A recipe with a high percentage of whole wheat flour may require a shorter kneading time than a recipe with white flour. The rough texture of the bran can be damaging to developing gluten.



Helpful Hints For Bread And Dough (cont.)

Dough Stretch Test: Testing For Developed Gluten

After approximately 10 minutes of kneading, stop the Mixer and check the gluten development by performing the dough stretch test. Remove a small piece of dough about the size of a small egg. Holding the dough up, carefully stretch it into a flat circle with your fingers. When the dough is properly developed, the structure will be smooth and stretchy; light should pass through the stretched dough. If the stretched dough breaks, it needs a few more minutes of kneading. The total time for kneading is approximately 10 minutes.

Yeast: The Number One Ingredient

We used Red Star® Active Dry Yeast when we were developing the bread recipes. A ¼ ounce package of Red Star Yeast contains approximately 2¼ level teaspoons of yeast. When the yeast is exposed to oxygen, moisture or warmth, the activity of it deteriorates. Therefore, we recommend storing yeast in an airtight container and refrigerating or freezing it. Measure out the amount you need and allow it to come to room temperature before using — this takes about 15 minutes.

If you have any doubt regarding the activity of the yeast, you may use the following test to determine its strength.

To test for one package (2¼ teaspoons) of Red Star® Active Dry Yeast, use a liquid measuring cup and fill it to the ½ cup level with 110°-115°F/43°-46°C water. Stir in 1 teaspoon granulated sugar and 1 package (2¼ teaspoons) Red Star® Active Dry Yeast. Leave your stirring spoon in the cup. Set a timer for 10 minutes. As the yeast absorbs liquid, it will begin to activate and rise to the surface. If at the end of the 10 minutes the yeast has multiplied to the 1 cup mark, it is very active. The yeast mixture may be used in a recipe that calls for 2¼ teaspoons or more of yeast. Remember to adjust your recipe for the ½ cup of water and 2¼ teaspoons of yeast used in the test. The sugar does not need to be adjusted. Add this mixture with the liquids in the recipe.

Flour: Bread Flour Is Essential For Bread

Use bread flour in yeast bread recipes. Bread flour is a white flour that is a blend of hard, high-protein wheats and has greater gluten strength and protein content than all-purpose flour. It is available at most grocery stores. Protein varies from 12-14 percent.

Pre-sifting or sifting the flour is not necessary with yeast bread. First stir, then spoon into a dry measuring cup and level off.

The amount of flour called for in a yeast bread recipe is meant as a guide. Dough is affected by heat, humidity, sugar, and altitude. If too much flour is used, the bread may be very heavy and stiff. If too little is used, the bread will not hold up and a low-volume bread will result.

Fat: Dough Enhancer And Conditioner

You may substitute in equal proportions solid shortening, real butter, or margarine. Light and whipped margarines do not work well.

Liquids: Activate The Yeast And Bind The Dough

It is important that the liquid temperature is 120°-130°F/49°-54°C. When higher temperatures are used, the yeast activates too quickly and the dough becomes too warm.

Rising Dough: Optimum Temperature Of Room 80°-85°F/27°-29°C

Rising times will vary due to recipe, temperature and humidity level of your kitchen. Rising is the most essential feature in bread making. After the dough comes out of the Mixer, the dough ferments and rises before punching and resting. The gluten becomes pliable and elastic with a soft, smooth quality. Fermentation conditions gluten, develops flavor and leavens the product.

Dough has doubled in bulk when an indentation remains after the tip of a finger is pressed lightly and quickly into the dough. If the indentation springs back, cover and let rise a few more minutes and check again. After punching down and dividing dough, cover and let rest 10 minutes. Resting allows the gluten to relax and makes handling easier. Then shape the dough as desired.



Rising Dough (cont.):

Optimum Temperature Of Room 80°-85°F/27°-29°C

Sometimes a second dough rising is beneficial especially for whole grain or 100% whole wheat bread. Let the dough rise once, punch down, let rise again, punch down, let rest 10 minutes and shape.

Storing And Freezing Baked Breads And Rolls

Refrigeration or temperatures under 70°F/21°C will cause breads to stale (firm) quickly. They can, however, be frozen for several months. When freezing breads and rolls, cool them before wrapping in plastic wrap. Place them in a plastic bag and seal it. When thawing, partially open the wrapping to allow the moisture to escape gradually. Do not remove ice crystals from the wrap during the thawing process. The bread will absorb some of this moisture as it thaws.

Freezing Dough

Form the dough into the desired shape and immediately freeze for one hour to harden. Remove from the freezer and wrap in plastic wrap. Next, place it in a plastic bag and seal. Dough can be kept in the freezer for up to four weeks. Thaw the dough in a plastic bag in the refrigerator overnight or for several hours. Unwrap and place on baking pan. Cover and let stand in a warm, draft-free place until double the original size. Because the dough is not at room temperature, you will find it takes longer than usual to rise. Bake according to recipe instruction.

Baking And Cooling

When baking sweet breads or braids, it may be necessary to tent the top of the bread with foil for the last 5-10 minutes. To tent, place a piece of foil, shiny side up, over the loaf. This will avoid over browning while the bread continues baking.

Cool baked bread in a draft-free area. To prevent soggy crust, cool on racks. Wait 20 minutes before cutting hot bread.

Shaping Dough And Rolls

When shaping and rolling out dough, it is extremely important not to add additional flour to the working surface. Instead, if dough appears to be slightly sticky when shaping, lightly spray your hands or working surface with a non-stick vegetable spray or coat with vegetable shortening.

Cloverleaf Rolls - Shape into $\frac{1}{2}$ inch balls. Place 3 balls in each muffin tin and let rise until double in size.

Crisscross Rolls - Shape into balls, setting two aside. Combine the two balls and roll into a $\frac{1}{8}$ inch thick square. Cut strips $\frac{1}{8}$ -inch wide and 2-inches long. Place one strip across the top of each roll. Repeat this process, placing the second strip in the opposite direction across the top of each roll.

Traditional Rolls - Shape into dough balls. For "pull apart" rolls, place dough balls with sides touching. For individual rolls, place dough balls 2 inches apart.



Doughs And Breads

BASIC WHITE DOUGH

2 Loaves or 18 Rolls

| | |
|-----------|------------------------------|
| 4-4¼ cups | bread flour |
| ¼ tsp | salt |
| ½ cup | sugar |
| 3½ tsp | active dry yeast |
| 1¼ cups | water |
| 1 | egg |
| ¼ cup | shortening, room temperature |

Temperature: 350°F/177°C

Bake Time: 25-30 minutes

Insert Dough Hooks and mix together all dry ingredients except 1 cup of flour on medium low for 30 seconds.

Heat water to 120°-130°F/49°-54°C. Continue mixing on Medium Low and add egg. Drizzle liquid slowly into dry mixture until mixed, 2-3 minutes. Continue to mix another 2-3 minutes. Gradually add the remaining flour to form a soft, slightly tacky dough ball, mixing for 3-5 minutes. Add shortening and mix for 3-4 minutes. Continue kneading for another 10 minutes. Perform dough stretch test.

Spray large bowl with a non-stick spray. Place dough in bowl and turn to coat on all sides. Cover and let rise in warm place 1 hour or until double in size. Punch down dough, cover and allow to rest 10 minutes to make the dough easier to handle.

Choose one of the following procedures to finish baking:

BREAD LOAVES

Temperature: 350°F/177°C

Bake Time: 25-30 minutes

Divide into 2 pieces and roll each into 1 12 x 7 inch rectangle. Roll up tightly, starting with narrow edge. Seal with fingertips as you roll. Place in 2 greased 9 x 5-inch baking pans. Cover and let rise in a warm place 1 hour or until double in size. Bake as directed.

Choose one of the following procedures to finish baking (cont.):

DINNER ROLLS

Temperature: 350°F/177°C

Bake Time: 25-30 minutes

Divide into 18 smooth 2-inch round rolls. Place in 1 greased 9 x 13-inch baking pan. Cover and let rise in a warm place 1 hour or until double in size. Bake as directed.

CINNAMON ROLLS

Topping

18 rolls

¾ cup butter, melted

½ cup sugar

3 TBL cinnamon

½ cup raisins

½ cup walnuts

Glaze

18 rolls

½ cup powdered sugar

3 TBL milk

½ tsp vanilla extract

Temperature: 350°F/177°C

Bake Time: 20-25 minutes

Combine sugar and cinnamon, set aside.

Roll dough into a 15 x 18 inch rectangle on a lightly floured surface. Spread melted butter over dough. Sprinkle with sugar-cinnamon mixture, raisins and nuts.

Roll up tightly, jelly-roll style, starting with the longest side and cutting into 1-inch slices. Place in 2 greased 9 x 13-inch baking pans. Cover and let rise in a warm place 1 hour or until double in size. Bake as directed.

Mix glaze ingredients until smooth and drizzle over top of baked cinnamon rolls.



FOCCACIA BREAD

2½ -3 cups bread flour
1 tsp salt
2 tsp sugar
1 tsp dry Italian seasoning
1¼ tsp active dry yeast
1 cup water
⅓ cup olive oil

Temperature: 400°F/205°C

Bake Time: 15-20 minutes

Insert Dough Hooks and mix all dry ingredients together except 1 cup of flour on Medium Low for 30 seconds.

Heat water and oil to 120°-130°F/49°-54°C. Continue mixing on Medium Low and drizzle liquid slowly into dry mixture until mixed, 2-3 minutes.

Continue to mix another 2-3 minutes. Gradually add the remaining flour to form a soft, slightly tacky, dough ball for 2-4 minutes. Continue kneading for another 10 minutes. Perform the dough stretch test.

Spray large bowl with a non-stick spray. Place dough in bowl and turn to coat on all sides. Cover and let rise in warm place 1 hour or until double in size.

Press dough evenly into a 9 x 13-inch greased pan. Make indentations in the dough using your fingertips.

Cover and let rise in a warm place for 20 minutes or until double in size. Prepare a topping, Garlic-Cheese or Greek Style, while the dough is rising.

GARLIC-CHEESE TOPPING

¼ cup olive oil
1½ tsp oregano leaves, dried
½ cup garlic, coarsely chopped
⅓ cup Parmesan cheese, grated
¼ tsp salt

Heat olive oil and stir in oregano and garlic. Remove from heat immediately. Spoon mixture over dough. Sprinkle with remaining ingredients. Bake as directed.

FOCCACIA BREAD (cont.)

GREEK STYLE TOPPING

| | |
|--------|------------------------------|
| ¼ cup | olive oil |
| 1½ tsp | oregano leaves, dried |
| 1 cup | onion, thinly sliced |
| ⅓ cup | Feta cheese, crumbled |
| ¼ cup | black olives, sliced-drained |
| ¼ tsp | salt |

Heat olive oil, add onions and cook until soft but not brown, 5 minutes.

Spoon mixture over dough. Sprinkle with remaining ingredients. Bake as directed.

FRENCH BREAD

Dough

| | |
|-----------|------------------|
| 3-3½ cups | bread flour |
| 1 tsp | salt |
| 1 TBL | sugar |
| 2½ tsp | active dry yeast |
| 1½ cups | water |

Glaze

| | |
|-------|-------|
| 1 TBL | water |
| ½ tsp | salt |

Temperature: 400°F/205°C

Bake Time: 20-25 minutes

Insert Dough Hooks and mix together all dry ingredients except 1-1½ cups of flour on Medium Low speed.

Heat water to 120°-130°F/49°-54°C. Continue mixing on Medium Low and drizzle water slowly into dry mixture until mixed, 2-3 minutes. Continue to mix another 2-3 minutes.

Gradually add the remaining flour to form a soft, slightly tacky, dough ball for 2-4 minutes. Continue kneading for another 10 minutes. Perform dough stretch test. Spray large bowl with a non-stick spray. Place dough in bowl and turn to coat on all sides. Cover and let rise in warm place 1 hour or until double in size.



FRENCH BREAD

Punch down dough, cover and allow to rest 10 minutes to make the dough easier to handle. Place dough on a lightly floured surface. Roll up tightly, starting with widest edge. Seal with fingertips as you roll.

Place the loaf on a greased baking sheet, cover and let rise in a warm place 45 minutes or until double in size. Cut three diagonal slashes across top of the loaf with a knife. Combine the glaze ingredients and brush the loaf generously. Bake as directed.

SOFT PRETZEL DOUGH

16 pretzels

Dough

| | |
|------------|------------------|
| 3-3½ cups | bread flour |
| 1 tsp | salt |
| 2 TBL | sugar |
| ⅛ tsp | white pepper |
| 1 TBL | active dry yeast |
| 1¼ cups | water |
| 1 TBL | oil |
| 1 egg yolk | |

Glaze

| | |
|-------|-----------|
| 1 | egg white |
| 1 TBL | water |

Topping

kosher salt
sesame seeds

Temperature: 350°F/176°C

Bake Time: 15-20 minutes

Insert Dough Hooks and mix together all dry ingredients except 1 cup of flour on Medium Low for 30 seconds.

Heat water and oil to 120°-130°F/49°-54°C. Continue mixing on Medium Low and drizzle water slowly into dry mixture until mixed, 2-3 minutes. Continue to mix for 2-3 minutes. Add egg yolk. Continue to mix for 2 minutes. Gradually add the remaining flour to form a soft, slightly tacky, dough ball; mix for 2-4 minutes. Continue kneading for another 10 minutes. Perform dough stretch test.

Spray large bowl with a non-stick spray. Place dough in bowl and turn to coat on all sides. Cover and let rise in warm place 1 hour or until double in size.

SOFT PRETZEL DOUGH (cont.)

Punch down dough, cover and allow to rest 10 minutes to make the dough easier to handle. Cut dough into pieces on a lightly floured surface. Roll each piece into a 16-inch rope. Cross the ends of the rope to make a loop; twist the crossed ends once and fold across the loop.

Place on a greased baking sheet 1½ inches apart. Brush with glaze and sprinkle with topping.

PIZZA CRUST

2 thick crusts or 3 thin crusts

| | |
|-----------|------------------|
| 4-4¼ cups | bread flour |
| 1 tsp | salt |
| 2 TBL | sugar |
| 2 tsp | active dry yeast |
| 1½ cups | water |
| 2 TBL | oil |

Temperature: 425°F/218°C

Bake Time: 15-20 minutes

Insert Dough Hooks and mix together all dry ingredients except 1 cup of flour on medium low for 30 seconds.

Heat water and oil to 120°-130°F/49°-54°C. Continue mixing on Medium Low and drizzle water slowly into dry mixture until mixed, 2-3 minutes. Continue to mix for another 2-3 minutes.

Gradually add the remaining flour to form a soft, slightly tacky, dough ball, 2-4 minutes. Continue kneading for another 10 minutes. Perform dough stretch test.

Spray large bowl with a non-stick spray. Place dough in bowl and turn to coat on all sides. Cover and let rise in warm place 1 hour or until double in size.

While dough is rising, prepare pizza sauce and toppings.

Punch down dough, divide equally per selected crust. Cover and allow to rest 10 minutes to make the dough easier to handle. Press dough evenly into greased 12-inch pizza pans. Spread each crust with pizza sauce and sprinkle with toppings.



PIZZA SAUCE

3 pizzas

| | |
|-------------|-------------------|
| 2 TBL | olive oil |
| 1 cup | onion, chopped |
| 1 8-oz can | tomato sauce |
| 1 14-oz can | tomatoes, chopped |
| ½ tsp | oregano |
| ½ tsp | basil |
| ⅛ tsp | garlic powder |
| ⅛ tsp | salt |
| 1 tsp | ground pepper |

Heat oil over medium heat and sauté onions until transparent. Stir in remaining ingredients, cover and simmer for 45 minutes, stirring occasionally. Spread 1 cup of sauce over pizza dough.

VEGETARIAN PIZZA TOPPINGS

2 pizzas

| | |
|----------|---------------------------|
| 1 small | zucchini, sliced |
| 1 medium | onion, sliced |
| 2 | cloves garlic, chopped |
| 1 | green pepper, chopped |
| 1 | red pepper, sliced |
| 1 cup | mushrooms, sliced |
| ½ cup | green olives, sliced |
| 1 cup | mozzarella cheese, grated |

Sprinkle toppings over sauce and bake as directed.

Heat olive oil and stir in oregano and garlic. Remove from heat immediately.

Spoon mixture over dough. Sprinkle with remaining ingredients. Bake as directed.

LIMITED ONE YEAR WARRANTY

Warranty: This Toastmaster® product is warranted to be free from defects in materials or workmanship for a period of (1) year from the original purchase date. This product warranty covers only the original consumer purchaser of the product.

Warranty Coverage: This warranty is void if the product has been damaged by accident in shipment, unreasonable use, misuse, neglect, improper service, commercial use, repairs by unauthorized personnel, normal wear and tear, improper assembly, installation or maintenance abuse or other causes not arising out of defects in materials or workmanship. This warranty is effective only if the product is purchased and operated in the USA, and does not extend to any units which have been used in violation of written instructions furnished with the product or to units which have been altered or modified or to damage to products or parts thereof which have had the serial number removed, altered, defaced or rendered illegible.

Implied Warranties: ANY IMPLIED WARRANTIES WHICH THE PURCHASER MAY HAVE ARE LIMITED IN DURATION TO ONE (1) YEAR FROM THE DATE OF PURCHASE. Some states do not allow limitations on how long an implied warranty lasts, so the above limitation may not apply to you.

Warranty Performance: During the above one-year warranty period, a product with a defect will be either repaired or replaced with a reconditioned comparable model (at our option) when the product is returned to the Repair Center, or the purchase price refunded. The repaired or replacement product will be in warranty for the balance of the one-year warranty period and an additional one-month period. No charge will be made for such repair or replacement.

Service and Repair: Should the appliance malfunction, you should first call toll-free 1 (800) 947-3744 between the hours of 9:00 am and 5:00 pm Central Standard Time and ask for CONSUMER SERVICE stating that you are a consumer with a problem. Please refer to model number TISM350 when you call.

In-Warranty Service (USA): For an appliance covered under the warranty period, no charge is made for service or postage. Call for return authorization 1 (800) 947-3744.

Out-of-Warranty Service: A flat rate charge by model is made for out-of-warranty service. Include \$ 10.00 (U.S.) for return shipping and handling. We will notify you by mail of the amount of the charge for service and require you to pay in advance for the repair or replacement.

For Products Purchased in the USA, but Used in Canada: You may return the product insured, packaged with sufficient protection, and postage and insurance prepaid to the USA address listed below. Please note that all customs duty / brokerage fees, if any, must be paid by you and we will require you to pay the cost of customs duty / brokerage fees to us in advance of our performing any service.

Risk During Shipment: We cannot assume responsibility for loss or damage during incoming shipment. For your protection, carefully package the product for shipment and insure it with the carrier. Be sure to enclose the following items with your appliance: any accessories related to your problem, your full return address and daytime phone number, a note describing the problem you experienced, a copy of your sales receipt or other proof of purchase to determine warranty status. C.O.D. shipments cannot be accepted.

To return the appliance, ship to:

Attn: Repair Center
Toastmaster Inc.
708 South Missouri Street
Macon, MO 63552
Email: consumer_relations@toastmaster.com
www.toastmaster.com

To contact us, please write to or call:

Toastmaster Inc.
P.O. Box 6916
Columbia, MO 65205-6916
1 (800) 947-3744

Limitation of Remedies: No representative or person is authorized to assume for us any other liability in connection with the sale of our products. There shall be no claims for defects or failure of performance or product failure under any theory of tort, contract or commercial law including, but not limited to negligence, gross negligence, strict liability, breach of warranty and breach of contract. Repair, replacement or refund shall be the sole remedy of the purchaser under this warranty, and in no event shall we be liable for any incidental or consequential damages, losses or expenses. Some states do not allow the exclusion or limitation of incidental or consequential damages, so the above limitation or exclusion may not apply to you.

Legal Rights: This warranty gives you specific legal rights, and you may also have other rights which vary from state to state.



Keep Dated Sales Receipt for Warranty Service.

Keep this booklet. Record the following for reference:

Date purchased _____

Model number _____

Date code (stamped on bottom) _____

EVERYBODY EATS. It's a fact of life.

But sometimes preparing
meals can become a chore.

That's why TOASTMASTER has been invited
into millions of kitchens just like yours
so we can HELP YOU MASTER your
mixing, baking, grilling, toasting,
brewing, heating and serving
tasks WITH EASE AND STYLE.

The TOASTMASTER name stands for a
CELEBRATION of INNOVATION designed
to serve your life and keep you
COOKIN' IN STYLE.

Contact Information

Coordonnées :

Contacte a:

Toastmaster Inc.

National Service Center
708 South Missouri Street
Macon, Mo 63552

In USA and Canada call:

Consumer Service: 1-800-947-3744

Consumer Parts: 1-800-947-3745

consumer_relations@toastmaster.com

Hours: 8:00 A.M. - 5:30 P.M. CST

Aux USA et au Canada, appeler les numéros suivants :

Service Consommateurs : 1-800-947-3744

Pièces Consommateurs : 1-800-947-3745

consumer_relations@toastmaster.com

Horaires : De 8h00 à 17h30, heure GMT - 6

En México:

Toastmaster de México, S.A. de C.V.

Cerrada de Recursos

Hidráulicos Número 6

La Loma Industrial

Tlalnepantla de Baz, C.P. 54060

Estado de México

52-5-397-2848

Horario: 8:00 a.m. hasta 5:30 p.m., hora del Centro

CONTACT US/APPELEZ



1-800-947-3744



www.toastmaster.com



consumer_relations@toastmaster.com

©2003 Toastmaster Inc.
A Subsidiary of Salton, Inc.
Subsidiaria de Salton, Inc.
A una Subsidiaria de Salton, Inc.



toastmaster®

23.



- **350-Watt Motor Handles Dense Mixtures**
- **Includes Large 4-Quart Stainless-Steel Mixing Bowl**
- **Power Boost Button for Peak Performance**
- **Soft Tech™ Ergonomic Controls**
- **Ejector Button**



Questions

Call toll free 1-800-947-3744

Monday – Friday, 8:00 a.m. - 5:30 p.m. CST

www.toastmaster.com

TMSM350