

# Operating and installation instructions

## Ceramic hobs with induction



To avoid the risk of accidents or damage to the appliance it is **essential** to read these instructions before it is installed and used for the first time.



<b>Warning and Safety instructions</b> . . . . .	5
<b>Guide to the appliance</b> . . . . .	14
Models . . . . .	14
KM 6328 . . . . .	14
KM 6366 / KM 6367 . . . . .	15
Sensor controls / displays . . . . .	16
Cooking zones . . . . .	18
<b>Caring for the environment</b> . . . . .	19
<b>Before using for the first time</b> . . . . .	20
Cleaning for the first time . . . . .	20
Before using for the first time . . . . .	20
<b>Induction</b> . . . . .	21
The induction principle . . . . .	21
Noises . . . . .	22
Pans . . . . .	23
<b>Power level range</b> . . . . .	24
<b>Operation</b> . . . . .	25
How the hob is operated . . . . .	25
To switch the hob on . . . . .	26
Setting and altering the power level . . . . .	26
PowerFlex cooking area . . . . .	26
Auto heat-up . . . . .	27
Booster . . . . .	28
Keeping warm function . . . . .	29
Switching off and residual heat indicators . . . . .	30
<b>Tips on saving energy</b> . . . . .	31
<b>Timer</b> . . . . .	32
Minute minder . . . . .	32
To switch a cooking zone off automatically . . . . .	33
To use both timer functions at the same time . . . . .	34
<b>Additional functions</b> . . . . .	35
Stop and Go . . . . .	35
Recall . . . . .	35
<b>Safety features</b> . . . . .	36
System lock . . . . .	36
Safety switch-off . . . . .	37
Overheating protection . . . . .	38

# Contents

---

<b>Cleaning and care</b> .....	39
<b>Problem solving guide</b> .....	41
<b>Optional accessories</b> .....	44
<b>Safety instructions for installation</b> .....	45
<b>Safety distances</b> .....	46
<b>Hob with frame or bevelled edge</b> .....	50
Installation notes .....	50
Building-in dimensions .....	51
KM 6328 .....	51
KM 6366 .....	52
Installing the hob .....	53
<b>Flush-fitted hobs</b> .....	54
Building-in dimensions .....	54
KM 6367 .....	54
Installing the hob .....	55
<b>Electrical connection</b> .....	58
Wiring diagram .....	59
<b>After sales service, data plate, guarantee</b> .....	60

## Warning and Safety instructions

---

This hob complies with all relevant safety requirements. Inappropriate use can, however, lead to personal injury and damage to property.

To avoid the risk of accidents and damage to the appliance, please read these instructions carefully before installation and before using it for the first time. They contain important notes on installation, safety, use and maintenance.

Miele cannot be held liable for damage caused by non-compliance with these Warning and Safety instructions.

Keep these instructions in a safe place and ensure that new users are familiar with the content. Pass them on to any future owner.

# Warning and Safety instructions

---

## Correct application

- ▶ This hob is not designed for commercial use. It is intended for use in domestic households and similar working and residential environments.
- ▶ The appliance is not intended for outdoor use.
- ▶ It is intended for domestic use only to cook food and keep it warm. Any other use is not supported by the manufacturer and could be dangerous.
- ▶ The appliance can only be used by people with reduced physical, sensory or mental capabilities, or lack of experience and knowledge, if they are supervised whilst using it, or have been shown how to use it in a safe way and recognise and understand the consequences of incorrect operation.

## Safety with children

- ▶ Children under 8 years of age must be kept away from the appliance unless they are constantly supervised.
- ▶ Children 8 years and older may only use the appliance unsupervised if they have been shown how to use it in a safe way and can recognise and understand the consequences of incorrect operation.
- ▶ Children must not be allowed to clean the appliance unsupervised.
- ▶ This appliance is not a toy! To prevent the risk of injury, do not allow children to play with the appliance or its controls.
- ▶ The appliance gets hot when in use and remains hot for a while after being switched off. Keep children well away from the appliance until it has cooled down and there is no danger of burning.
- ▶ Danger of suffocation. Packaging, e.g. plastic wrappings, must be kept out of the reach of babies and children. Whilst playing, children could become entangled in packaging, or pull it over their head and suffocate.
- ▶ Danger of burning.  
Do not store anything which might arouse a child's interest in storage areas above or behind the appliance. Otherwise they could be tempted into climbing onto the appliance
- ▶ Danger of burning or scalding.  
Place pots and pans on the cooking zone in such a way that children cannot pull them down and burn themselves.
- ▶ Activate the system lock to ensure that children cannot switch on the appliance inadvertently. Use the safety lock when the hob is in use to prevent children from altering the settings selected.

# Warning and Safety instructions

---

## Technical safety

- ▶ Unauthorised installation, maintenance and repairs can cause considerable danger to users. Installation, maintenance and repair work must only be carried out by a Miele authorised technician.
- ▶ A damaged appliance can be dangerous. Check the appliance for visible signs of damage. Do not use a damaged appliance.
- ▶ The electrical safety of this appliance can only be guaranteed if correctly earthed. It is most important that this basic safety requirement is observed and regularly tested, and where there is any doubt, the installation should be inspected by a qualified electrician.
- ▶ To avoid the risk of damage to the appliance, make sure that the connection data (frequency and voltage) on the data plate corresponds to the household supply, before connecting the appliance to the mains supply.  
Consult a qualified electrician if in any doubt.
- ▶ Do not connect the appliance to the mains electrical supply by an extension lead. These are a fire hazard and do not guarantee the required safety of the appliance.
- ▶ For safety reasons, this appliance may only be used after it has been built in.
- ▶ This appliance must not be used in a non-stationary location (e.g. on a ship).
- ▶ Do not open the casing of the appliance.  
Tampering with electrical connections or components and mechanical parts is highly dangerous to the user and can cause operational faults.



## Warning and Safety instructions

---

- ▶ While the appliance is under guarantee, repairs should only be undertaken by a service technician authorised by Miele. Otherwise the guarantee is invalidated.
- ▶ The manufacturer can only guarantee the safety of the appliance when original Miele replacement parts are used. Faulty components must only be replaced by genuine Miele original spare parts.
- ▶ The hob is not intended for use with an external timer switch or a remote control system.
- ▶ The hob must be connected to the electrical supply by a qualified electrician. If the connection cable is faulty, it must be replaced with a special connection cable installed by a qualified electrician. See "Electrical connection".
- ▶ The appliance must be disconnected from the mains electricity supply during installation, maintenance and repair work. Ensure that power is not supplied to the appliance until after it has been installed or until any maintenance or repair work has been carried out.
- ▶ If the hob is fitted with a communication module, in addition to disconnecting the hob, this module must also be disconnected from the mains electricity during installation and maintenance of the hob as well as while any repair work is being carried out.
- ▶ Danger of electric shock.  
Do not use the hob if it is faulty, or if the ceramic surface is cracked, chipped or damaged in any way. Switch it off immediately, and disconnect it from the mains electricity supply.
- ▶ In areas which may be subject to infestation by cockroaches or other vermin, pay particular attention to keeping the appliance and its surroundings in a clean condition at all times. Any damage which may be caused by cockroaches or other vermin will not be covered by the guarantee.

# Warning and Safety instructions

---

## Correct use

- ▶ Oil and fat can overheat and catch fire. Do not leave the appliance unattended when cooking with oil or fat.  
If oil or fat does catch fire, do not attempt to put out the flames with water. Disconnect the appliance from the mains and use a suitable fire blanket, saucepan lid, damp towel or similar to smother the flames.
- ▶ Flames could set the grease filters of a cooker hood on fire. Do not flambé under a cooker hood.
- ▶ Spray canisters, aerosols and other inflammable substances can ignite when heated. Therefore do not store such items or substances in a drawer under the appliance. Cutlery inserts must be heat-resistant.
- ▶ Do not heat an empty pan.
- ▶ Do not heat up unopened tins of food on the hob, as pressure will build up in the tin, causing it to explode.
- ▶ Do not cover the hob, e.g. with a hob cover, a cloth or protective foil. The material could catch fire, shatter or melt if the appliance is switched on by mistake or if residual heat is still present.
- ▶ When using an electrical appliance, e.g. a hand-held food blender, near the appliance, ensure that the cable of the electrical appliance cannot come into contact with the hot appliance. The insulation on the cable could become damaged.
- ▶ If the appliance is installed behind a kitchen furniture door, it may only be used with the furniture door open. Do not close the door whilst the hob is in use or whilst there is any residual heat present.
- ▶ The appliance gets hot when in use and remains hot for a while after being switched off. There is a danger of burning until the residual heat indicators go out.

## Warning and Safety instructions

---

▶ You could burn yourself on the hot hob. Protect your hands with heat-resistant pot holders or gloves when handling hot pots and pans. Do not let them get wet or damp, as this causes heat to transfer through the material more quickly with the risk of scalding or burning yourself.

▶ When the appliance is switched on either deliberately or by mistake, or when there is residual heat present, there is the risk of any metal items left on the hob heating up, with the danger of burning.

Depending on the material, other items left on the hob could also melt or catch fire.

Damp pan lids might adhere to the ceramic surface and be difficult to dislodge.

Do not use the appliance as a resting place.

Switch the cooking zones off after use.

▶ Do not allow solid or liquid sugar, or pieces of plastic or aluminium foil to get onto the cooking zones when they are hot, as they can damage the ceramic surface when it cools down. If this should occur, switch off the appliance and scrape off all the sugar, plastic or aluminium residues whilst still hot, using a shielded scraper blade. Wear oven gloves.

Allow the cooking zones to cool down and then clean them with a suitable ceramic hob cleaning agent.

▶ Pans which boil dry can cause damage to the ceramic glass. Do not leave the appliance unattended whilst it is being used.

▶ Do not use pots or pans on the hob with bases with pronounced edges or ridges. These could scratch or scour the ceramic glass surface permanently. Only use pots and pans with smooth bases.

▶ Lift pans into position on the hob. Sliding them into place can cause scuffs and scratches.

## Warning and Safety instructions

---

- ▶ Grains of salt, sugar and sand (e.g. from cleaning vegetables) can cause scratches if they get under pan bases. Make sure that the ceramic surface is clean before placing pans on it.
- ▶ Even a light object could cause damage in certain circumstances. Do not drop anything on the ceramic surface.
- ▶ Do not place hot pans on the sensors and display as this could cause damage to the electronics underneath. Do not place hot pans on the area around the display.
- ▶ Induction heating works extremely quickly and so the base of the pan could heat up to the temperature at which oil or fat self-ignites within a very short time. Do not leave the appliance unattended whilst it is being used.
- ▶ Heat oil or fat for a maximum of one minute. Do not use the Booster function to heat oil or fat.
- ▶ For people fitted with a heart pacemaker:  
Please note that the area immediately surrounding the hob is electromagnetically charged. It is unlikely to affect a pacemaker. However, if in any doubt, consult the manufacturer of the pacemaker or your doctor.
- ▶ To prevent damage to items which are susceptible to magnetic fields, e.g. credit cards, digital storage devices, pocket calculators, etc, do not leave them in the immediate vicinity of the hob.
- ▶ Metal utensils stored in a drawer under the hob can become hot if the appliance is used intensively for a long time. Do not store any metal items or utensils in a drawer under the hob.

## Warning and Safety instructions

---

▶ This hob is fitted with a cooling fan. If a drawer is fitted directly underneath the hob, ensure that there is sufficient space between the drawer and its contents and the underside of the appliance in order to ensure sufficient ventilation of the hob.

Do not store pointed or small items or paper in the drawer. They could get in through the ventilation slots or be sucked into the housing by the fan and damage the fan or impair cooling.

▶ Do not use two pans on a cooking zone, extended zone or PowerFlex zone at the same time.

### **Cleaning and care**

▶ Do not use a steam cleaning appliance to clean this appliance. The steam could reach electrical components and cause a short circuit.

▶ If the hob is built in over a pyrolitic oven or cooker, the hob should not be used whilst the pyrolitic process is being carried out, as this could trigger the overheating protection mechanism on the hob (see relevant section).

# Guide to the appliance

---

## Models

### KM 6328

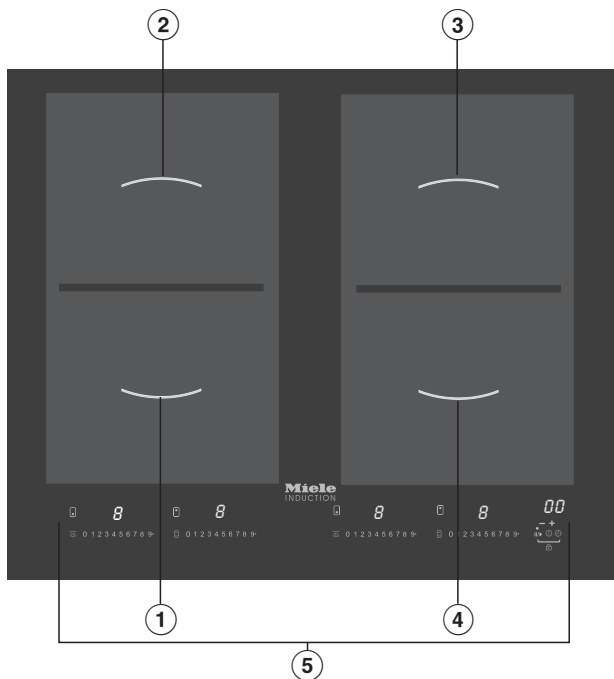

①②③④ PowerFlex cooking zones with TwinBooster

can be combined to form a PowerFlex cooking area:

① + ②

③ + ④

⑤ Control panel

## KM 6366 / KM 6367

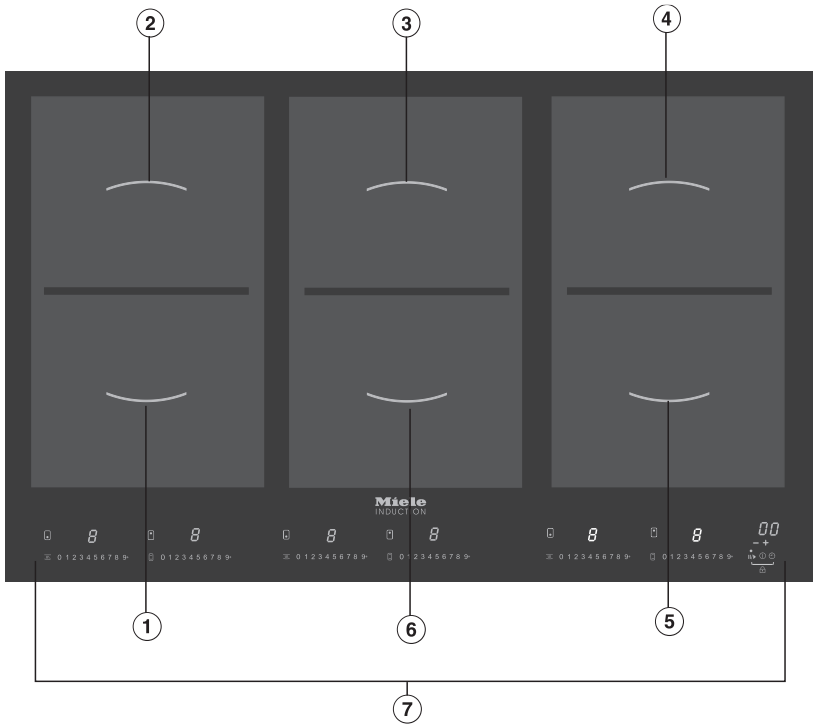

①② PowerFlex cooking zones with Booster

③④⑤⑥ PowerFlex cooking zones with TwinBooster

can be combined to form a PowerFlex cooking area:

① + ②

③ + ⑥

④ + ⑤

⑦ Control panel

# Guide to the appliance

## Sensor controls / displays

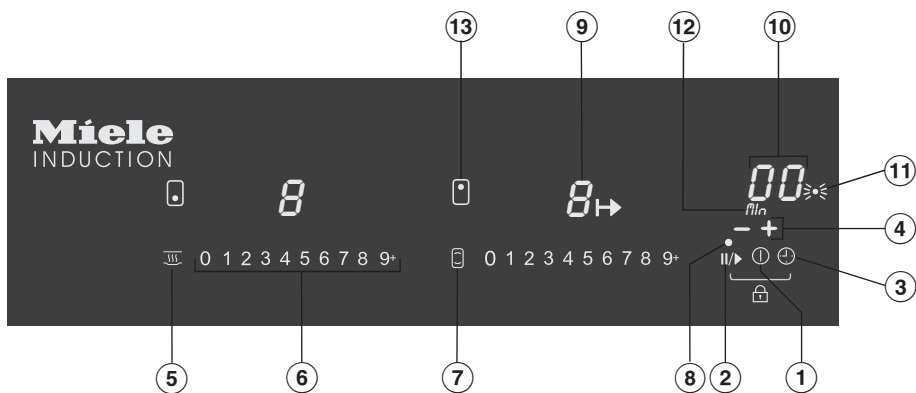







## Sensor controls

- ① On/Off
- ② Stop and Go
- ③ Timer
  - For switching on
  - For switching between timer functionsFor selecting the switch-off time (see "To switch off a cooking zone automatically")
- ④ For setting the time
- ⑤ Keeping warm function
- ⑥ For setting the power level
- ⑦ For switching on the PowerFlex cooking area
- ① + ② System lock

## Indicator lights

- ⑧ System lock

## Cooking zone displays









- ⑨
  -  = Cooking zone ready for use
  - h* = Keeping warm function
  - 1 to 9* = Power levels
  - 1* = Level 1 TwinBooster
  - 11* = Booster/TwinBooster level 2
  -  = No pan on cooking zone or pan unsuitable (see "Induction")
  -  = Residual heat
  - R* = Auto heat-up
  -  = Automatic switch-off programmed













## Timer display

- ⑩ = Duration in minutes
- ⑪ = Indicator light
- ⑫ = Minute minder display

# Guide to the appliance

## Cooking zones

Cooking zone	KM 6328	
	Minimum to maximum Ø in cm*	Rating in watts for 230 V**
   	15–23	Normal 2100 TwinBooster level 1 3000 TwinBooster level 2 3700
 +   + 	22–23 / 15 x 23 – 23 x 39	Normal 3400 TwinBooster level 1 4800 TwinBooster level 2 7400
		Total: 7400

Cooking zone	KM 6366 / KM 6367	
	Minimum to maximum Ø in cm*	Rating in watts for 230 V**
     	15–23	Normal 2100 TwinBooster level 1 3000 TwinBooster level 2 3700
 + 	22–23 / 15 x 23 – 23 x 39	Normal 3400 Booster 3700
 +   + 	22–23 / 15 x 23 – 23 x 39	Normal 3400 TwinBooster level 1 4800 TwinBooster level 2 7400
		Total: 11100

\* Pans of any base diameter within the given range may be used.

\*\* The wattage quoted may vary depending on the size and material of the pans used.

### Disposal of the packing material

The packaging is designed to protect the appliance from damage during transportation. The packaging materials used are selected from materials which are environmentally friendly for disposal and should be recycled.

Recycling the packaging reduces the use of raw materials in the manufacturing process and also reduces the amount of waste in landfill sites.

### Disposing of your old appliance

Electrical and electronic appliances often contain valuable materials. They also contain materials which, if handled or disposed of incorrectly, could be potentially hazardous to human health and to the environment. They are, however, essential for the correct functioning of your appliance. Please do not therefore dispose of it with your household waste.

Please dispose of it at your local community waste collection/recycling

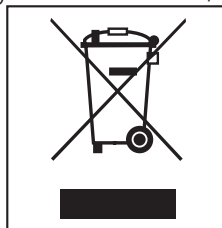

centre or contact your dealer for advice. Ensure that it presents no danger to children while being stored for disposal.

## Before using for the first time

---

Please stick the extra data plate for the appliance supplied with this documentation in the space provided in the "After sales service, data plate, guarantee" section of this booklet.

### Cleaning for the first time

- Remove any protective wrapping and adhesive labels.
- Before using for the first time, clean the appliance with a damp cloth only and then wipe dry.

### Before using for the first time

On hobs with bevelled glass edges, a small gap may be visible between the hob and the worktop during the first few days after installation. This gap will reduce with time as the appliance is used and will not affect the electrical safety of your appliance.

The metal components have a protective coating which may give off a slight smell when heated up for the first time. The induction coils may also give off a slight smell for the first few hours of operation. This smell will be less noticeable with each subsequent use before dissipating completely.

The smell and any vapours given off do not indicate a faulty connection or appliance and they are not hazardous to health.

Please note that the heating up time on induction hobs is very much shorter than on conventional hobs.

## The induction principle

An induction coil is located under each cooking zone. When a cooking zone is switched on, this coil creates a magnetic field which impacts directly on the base of the pan and heats it up. The cooking zone itself is heated up indirectly by the heat given off by the pan.

An induction cooking zone only works when a ferromagnetic pan is placed on it (see "Pans"). The induction cooking zone automatically recognises the size of the pan

The  symbol flashes alternately with the power setting selected in one of the cooking zones

- if it is switched on without a pan in place, or if the pan is unsuitable (non-magnetic base),
- if the diameter of the base of the pan is too small,
- if the pan is taken off the cooking zone when it is switched on.

If a suitable pan is placed on the cooking zone within 3 minutes, the  will go out and you can continue as normal.

If no pan or an unsuitable pan is placed on the cooking zone, the cooking zone will switch off automatically after 3 minutes.

Danger of burning.

Do not use the hob as a resting place for metal items (e.g. cutlery). When the appliance is switched on either deliberately or by mistake, or when there is residual heat present, there is the risk of the metal items heating up, with the danger of burning.

Switch the hob off after use.

# Induction

---

## Noises

When using an induction cooking zone, the following noises can occur in the pan, depending on what it is made of and how it has been constructed.

- On the higher power levels, it might buzz. This will decrease or cease altogether when the power level is reduced.
- If the pan base is made of layers of different materials (e.g. in a sandwiched base), it might emit a cracking sound.
- Whistling might occur if linked zones (see "Booster") are being used at the same time, and the pans also have bases made of layers of different materials.
- You might hear a clicking sound from the electronic switches, especially on lower power levels.
- You might hear a whirring sound when the cooling fan switches on. It switches on to protect the electronics when the hob is being used intensively. The fan may continue to run after the appliance has been switched off.

## Pans

### **Suitable pans include:**

- stainless steel pans with a magnetic base
- enamelled steel pans
- cast iron pans

### **Unsuitable pans:**

- stainless steel pans without a magnetic base
- aluminium and copper pans
- glass, ceramic or earthenware pots and pans

To test whether a pot or pan is suitable for use on an induction hob, hold a magnet to the base of the pan. If the magnet sticks, the pan is suitable.

Please be aware that the properties of the pan base can affect the evenness with which food heats up in the pan.

To make optimum use of the cooking zones, choose pans with diameters larger than the innermost markings but smaller than the outermost markings. If the diameter of the pan is smaller than the innermost marking, the induction heating will not work. The zone will behave as if it had no pan on it.

Often the maximum diameter quoted by manufacturers refers to the diameter of the top rim of the pot or pan. The diameter of the base (generally smaller) is more important.

Danger of burning. Make sure that pans are placed centrally on the cooking zone. If a pan is placed only partially on a zone, there is a risk that the handle could get very hot.

## Power level range

---

	<b>Settings</b>
Melting butter Dissolving gelatine	1 to 2
Making milk puddings	2
Warming small quantities of liquid Cooking rice Defrosting frozen vegetables Cooking pulses	3
Warming liquid and semi-solid foods Making omelettes and lightly frying eggs Steaming fruit Cooking dumplings	4
Steaming vegetables, fish Defrosting and reheating frozen food	5
Bringing large quantities of food to the boil, e.g. casseroles Thickening custard and sauces, e.g. hollandaise Gently frying eggs (without overheating the fat)	6
Gentle braising (without overheating the fat) of meat, fish, vegetables Frying pancakes etc.	7
Cooking stew	8
Boiling large quantities of water Bringing to the boil	9

These settings should only be taken as a guide.

The power of the induction coils will vary depending on the size and material of the pan. For this reason it is possible that the settings will need to be adjusted slightly to suit your pans. As you use the hob, you will get to know which settings suit your pans best.



## How the hob is operated

The hob is equipped with electronic sensor controls which react to finger contact.

To operate the hob, touch the relevant sensor. Each time you touch a sensor, an audible tone sounds.

Take care to keep the control panel clean and do not place anything on top of it. The sensors may fail to react or they could mistake the article or any dirt for a fingertip contact, thereby activating a function or even causing the hob to switch off automatically (see "Safety switch-off"). Never place hot pans on the sensors. The electronic unit underneath could get damaged.

# Operation

---

Do not leave the appliance unattended whilst it is being used.

## To switch the hob on

- Touch the  sensor.

 will appear in each of the cooking zone displays. If no further entry is made, the hob will switch itself off after a few seconds for safety reasons.

## Setting and altering the power level

- Touch the appropriate number on the numerical keypad of the cooking zone you wish to use.

The selected power level is shown in the cooking zone display.

## PowerFlex cooking area

All the rear cooking zones can be combined with the ones in front of them to form a PowerFlex cooking area. The cooking area is operated by the front cooking zone and the  symbol appears in the display for the rear cooking zone.

## Activating/deactivating

- Touch the  sensor.

## Auto heat-up

When Auto heat-up has been activated, the cooking zone switches on automatically at the highest power setting and then switches to the continued cooking setting selected. The heat-up time depends on which continued cooking setting has been chosen (see chart).

### To activate Auto heat-up

- Touch the number of the continued cooking setting you require until a tone sounds and the continued cooking setting selected starts flashing.

The continued cooking setting selected will flash during the heat-up time, alternating with *R*.

Altering the continued cooking setting will deactivate auto heat-up.

### To deactivate Auto heat-up

- Touch the continued cooking setting which has been selected until the display lights up constantly
- or
- select a different power level.

Continued cooking setting	Heat-up time in minutes and seconds (approx.)
1	0 : 15
2	0 : 15
3	0 : 25
4	0 : 50
5	2 : 00
6	5 : 50
7	2 : 50
8	2 : 50
9	-

# Operation

---

## Booster

The cooking zones are equipped with a Booster or TwinBooster (see "Guide to the appliance").

When activated, the power is boosted for a maximum of 10 minutes so that large quantities can be heated up quickly, e.g. when boiling water for cooking pasta.

Taking a pan off the zone whilst the Booster is in operation interrupts the Booster function.

The cooking zone will automatically revert to power setting 9 at the end of the booster time.

Cooking zones are networked in pairs to supply power for the Booster function.

When the Booster function is selected a proportion of energy is taken away from the linked cooking zone. The following happens within the pairs:

- Auto heat-up is deactivated
- The power level is reduced
- The linked cooking zone is switched off.

### To switch on the Booster

- Touch the "9" twice on the numerical keypad of the cooking zone you wish to use.

„ will light up in the display.

### To switch on the TwinBooster

#### Level 1

- Touch the "9" twice on the numerical keypad of the cooking zone you wish to use.

„ will light up in the display.

#### Level 2

- Touch the "9" three times on the numerical keypad of the cooking zone you wish to use.

„ will light up in the display.

### To switch off the Booster/TwinBooster

- Select a different power level.

## Keeping warm function

Each cooking zone has a keeping warm function.

This function is for keeping food that has just been cooked warm, i.e. food that is still hot. It is not for reheating food that has gone cold.

If the keeping warm function has been activated, the cooking zone will switch off automatically after a maximum of 2 hours.

### To switch the keeping warm function on/off

- Touch the  sensor for selecting the cooking zone you want.

### Useful tips

- Only use pans for keeping food warm. Cover the pan with a lid.
- You do not have to stir food while it is being kept warm.
- Nutrients are lost when food is cooked, and this will continue when food is kept warm. The longer food is kept warm for, the greater the loss of nutrients. Try to ensure that food is kept warm for as short a time as possible.

# Operation

---

## Switching off and residual heat indicators

### Switching off a cooking zone

- Touch the "0" on the numerical keypad of the cooking zone you wish to use.

A 0 will flash in the cooking zone display for a few seconds. If the cooking zone is still hot, the residual heat indicator will then appear in the display.

### Switching off the hob

- Touch the ① sensor.

This switches off all cooking zones. The residual heat indicator will appear in the display of any cooking zone which is still hot.

### Residual heat indicator

The lines of the residual heat indicator go out one after another as the cooking zone cools down. The last horizontal line only goes out when the cooking zone is safe to touch.

Danger of burning and fire hazard.  
Do not touch the cooking zones whilst the residual heat indicators are lit up.

## Tips on saving energy

---

- Use a pan lid whenever possible to minimise heat loss.

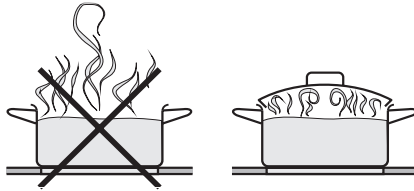

uncovered

covered

- Select a smaller pan when cooking small quantities. A smaller pan uses less energy than a larger pan with very little in it.
- Cook with as little water as possible.
- Once food has come to the boil or the oil in the pan is hot enough for frying, reduce the heat to a lower setting.
- Cooking times are greatly reduced when using a pressure cooker.

# Timer

---

The timer can be used for two different functions:

- to set the minute minder
- to set a cooking zone to switch off automatically.

You can enter a time up to a maximum of 99 minutes.

When the set time has elapsed **00** will appear in the display. At the same time a buzzer will sound for a few seconds.

- Touch the - or + sensor to switch off the audible tone.

## Minute minder

The minute minder can be used with the hob switched on or off.

### To set the minute minder time

- Touch the ⊕ sensor.
- Touch the - or + sensor until the time you require appears in the display, e.g. 15 minutes.

The minute minder time will begin to count down.

### Changing the minute minder time

- Touch the ⊕ sensor.
- Set the time you want, as described above.

### Deleting the minute minder time

- Touch the ⊕ sensor.
- Touch the - or + sensor until **00** appears in the timer display.



## To switch a cooking zone off automatically

You can set a time at the end of which a cooking zone will switch off automatically.

All the cooking zones can be programmed at the same time.

If the time programmed is longer than the maximum operational time allowed, the cooking zone will switch off after the maximum time allowed (see "Safety switch-off").

- Select a power level for the cooking zone you require.
- Touch the ⊕ sensor repeatedly until the ⇨ symbol appears in the display of the cooking zone you require.
- Touch the - or + sensor until the time you require appears in the display, e.g. 15 minutes.

If you want to set another cooking zone to switch off automatically, follow the same steps as described above.

If more than one switch-off time is programmed, the shortest time remaining will show in the display and the ⇨ symbol will light up in the display for the corresponding cooking zone. If you want to check on the time remaining for another zone, touch the ⊕ sensor repeatedly until the ⇨ symbol appears in the display of the cooking zone you require.

# Timer

---

## To use both timer functions at the same time

The minute minder and automatic switch-off functions can be used at the same time.

If you have programmed in one or more switch-off times and would like to use the **minute minder as well**:

- Touch the ⊕ sensor repeatedly until *00* and *Min* appear in the timer display.

If you are using the minute minder and would like to programme in **one or more switch-off times as well**:

- Touch the ⊕ sensor until the ⇨ symbol appears in the display of the cooking zone you require.

Shortly after the last entry, the shortest remaining time will come up in the display. If you want to check on the time remaining for another light zone, touch the ⊕ sensor repeatedly until the indicator light for the zone you require flashes.

### Stop and Go

Your appliance has a Stop and Go feature which, when activated, reduces the power of all cooking zones in use to power level 1. When Stop and Go is activated, the cooking zone power levels and the setting of the timer cannot be altered and the hob can only be switched off.

When Stop and Go is deactivated the cooking zones resume at the power level which was last set and any programmed times will continue to run.

If the function is not deactivated within 10 minutes, the hob will switch off.

### Activating/deactivating

- Touch the **II/▶** sensor.

### Recall

If the hob is accidentally switched off during use, you can restore all settings using this function. The hob must be switched on again within 6 seconds.

- Switch the hob back on.
- Touch the **II/▶** sensor within 6 seconds of switching back on.

# Safety features

---

## System lock

The hob is fitted with a system lock to prevent it from being switched on without supervision.

If the hob is switched on when the system lock is active, *LC* appears in the timer display for a few seconds.

The system lock is deactivated if there is an interruption to the power supply.

### To activate the system lock

- Switch the hob on.
- Touch the **II/▶** and **⊕** sensors at the same time until "*LC*" appears in the timer display.

### To deactivate the system lock

- Switch the hob on.
- Touch the **II/▶** and **⊕** sensors at the same time until "*LC*" in the timer display goes out.

### Safety switch-off

#### Safety switch-off with an over-long cooking time

If one of the cooking zones is heated for an unusually long period of time (see chart) and the power level is not altered, the hob will switch itself off automatically and the relevant residual heat indicator will light up.

To use the cooking zone again, switch it back on in the usual way.

Power level*	Maximum operating time in hours
1	10
2	5
3	5
4	4
5	3
6	2
7	2
8	2
9	1

#### Safety switch-off if the sensors are covered

Your hob will switch off automatically if one or several of the sensors remain covered for more than about 10 seconds, for example by finger contact, food boiling over, or by an object such as an oven glove or a tea towel.

A "Flash" will appear in the timer display and an audible tone sounds.

- Clean the control panel or remove the obstruction.

The timer display will go out and the audible tone will cease. You can now use the hob again.

# Safety features

---

## Overheating protection

All the induction coils and the cooling elements for the electronics are fitted with an overheating protection mechanism. Before the induction coils or cooling elements get too hot, the overheating protection mechanism cuts in in one of the following ways:

- If the booster function is being used, this will be switched off.
- The power level will be reduced.
- The cooking zone will switch off automatically. "E2" appears in the cooking zone display.

You will be able to use the cooking zones again as usual when the fault code has gone out.

The overheating mechanism can be triggered by:

- Heating up an empty pan.
- Fat or oil being heated up on a high power level.
- Insufficient ventilation to the underside of the appliance.
- A hot cooking zone being switched on after a power cut.

If the overheating protection mechanism triggers again, contact the Service department.

Danger of injury.

Do not use a steam cleaning appliance to clean this appliance. The steam could reach electrical components and cause a short circuit.

The appliance should be cleaned after each use. Let it cool down to room temperature before cleaning.

To avoid water marks and limescale deposits, use a soft cloth to dry the appliance after cleaning.

**To avoid damaging the surface of your appliance, do not use:**

- washing-up liquid,
- cleaning agents containing soda, alkalines, ammonia, acids or chlorides,
- cleaning agents containing descaling agents,
- stain or rust removers,
- abrasive cleaning agents, e.g. powder cleaners and cream cleaners,
- solvent-based cleaning agents,
- dishwasher cleaner,
- grill and oven cleaners,
- glass cleaning agents,
- hard, abrasive brushes or sponges, e.g. pot scourers, or sponges which have been previously used with abrasive cleaning agents,
- melamine eraser blocks,
- sharp, pointed objects which could damage the seal between the ceramic surface and the surrounding frame, and between the frame and the worktop.

## Cleaning and care

---

Do not use washing-up liquid to clean the ceramic surface. Washing-up liquid will not remove all soiling and deposits. It will form an invisible coating which will cause permanent discolouration of the ceramic surface. Clean the hob regularly with a suitable ceramic hob cleaning agent.

Wipe off all coarse soiling using a damp cloth. Stubborn soiling may need to be removed with a shielded scraper blade.

Then clean the hob with Miele ceramic and stainless steel hob cleaner (see "Optional accessories") applied with kitchen paper or a clean cloth. Do not apply cleaner whilst the appliance is still hot, as this could result in marking. Please follow the manufacturer's instructions.

Finally wipe the hob with a damp cloth, then dry with a soft, dry cloth. Residues can burn onto the appliance the next time it is used, and cause damage to the ceramic surface. Ensure that all cleaning agent residues are removed.

**Spots** caused by limescale, water and aluminium residues (spots with a metallic appearance) can be removed using Miele's ceramic and stainless steel hob cleaner.

Danger of burning.

Protect your hands with oven gloves before using a shielded scraper blade to remove sugar, plastic or aluminium residues from the hot hob.

Should any **sugar, plastic or aluminium foil** spill or fall onto a hot cooking zone while it is in use, first switch off the appliance. Then carefully scrape off all the sugar, plastic or aluminium residues from the hob **immediately** whilst they are still hot, using a shielded scraper blade.

Allow the appliance to cool down and then clean as described above.



## Problem solving guide

With the help of the following notes, minor faults in the performance of the appliance, some of which may result from incorrect operation can be put right without contacting the Service Department.

Installation work and repairs to electrical appliances must only be carried out by a suitably qualified and competent person in strict accordance with current local and national safety regulations. Do not open the casing of the appliance. Repairs and other work by unqualified persons could be dangerous and Miele cannot be held liable for unauthorised work.

Problem	Possible cause	Remedy
<b>The hob or cooking zones cannot be switched on.</b>	The mains fuse has tripped.	Reset the trip switch in the mains fuse box (minimum fuse rating - see data plate).
	There may be a technical fault.	Disconnect the appliance from the electricity supply for approx. 1 minute. To do this: <ul style="list-style-type: none"><li>– switch off at the isolator, or</li><li>– disconnect the mains fuse.</li></ul> Reset the trip switch in the mains fuse box, and switch the appliance back on. If it still will not switch on, contact a qualified electrician or the Miele Service Department.

## Problem solving guide

Problem	Possible cause	Remedy
<b>A smell and vapours are given off when a new appliance is being used.</b>		The smell and vapours will be less noticeable with each subsequent use before dissipating completely.
<b>The <math>\cup</math> symbol flashes alternately with the power setting selected in one of the cooking zones.</b>	There is no pan on the cooking zone, or the pan is unsuitable.	Use a suitable pan (see "Pans").
<b>After the hob is switched on "LC" appears in the timer display for a few seconds.</b>	The system lock is activated.	Deactivate the system lock (see "Safety lock / System lock").
<b>A cooking zone switches off automatically.</b>	It has been in use for too long.	You can use the cooking zone again by switching it back on (see "Safety switch-off").
<b>The Booster has deactivated early automatically.</b>	The overheating protection mechanism has triggered.	See "Overheating protection".
<b>The cooking zone is not working in the usual way at the power level set.</b>		
<b>Power level 9 is automatically reduced if you select power level 9 on two linked cooking zones or extended zones at the same time.</b>	Operating both zones at power level 9 would exceed the permitted maximum power level for the two zones.	

## Problem solving guide

Problem	Possible cause	Remedy
<b>The hob switches off while it is in use and a "flash" appears in the timer display.</b>	One or more of the sensors have been covered, e.g. by finger contact, food boiling over or by an object such as an oven glove.	Clean the control panel or remove the obstruction (see "Safety switch-off").
<b>The food in the pan does not heat up when the Auto heat-up function is switched on.</b>	There is too much food in the pan.	Start cooking at the highest power level and then turn down to a lower one manually later on.
	The pan is not conducting heat properly.	
<b>The cooling fan continues to run even after the appliance has been switched off.</b>	The fan will continue running until the appliance has cooled down. It will then switch itself off automatically.	
<b>U and numbers are flashing in the cooking zone displays and an audible tone is sounding.</b>	The hob is incorrectly connected.	Connect the hob to the mains according to the wiring diagrams.
<b>E or ER and numbers are flashing in the cooking zone displays.</b>		
<b>E 2</b>	The overheating protection mechanism has triggered.	See "Overheating protection".
<b>Other fault messages E.. or "ER .."</b>	There is an electronic fault.	Interrupt the power supply to the hob for approx. 1 minute. If the problem persists after reconnecting the appliance to the power supply, please contact the Miele Service department.

## Optional accessories

---

Miele offer a comprehensive range of useful accessories as well as cleaning and conditioning products for your Miele appliances.

These can be ordered online at:



or from Miele (see back of manual for contact details).

## Pans

Miele offer a wide range of pans which are perfect for Miele hobs. Please refer to the Miele website for more details on individual products.

Pans in various sizes

Frying pan with lid

Anti-stick pans

Wok

Gourmet oven dish

## Cleaning products

### Ceramic and stainless steel hob cleaner

250 ml



Removes heavy soiling, limescale deposits and aluminium residues.

### E-cloth (microfibre cloth)

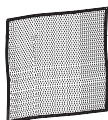

Removes finger marks and light soiling.

## Safety instructions for installation

---

The appliance must only be installed and connected to the electricity supply by a suitably qualified and competent person in strict accordance with current national and local safety regulations. Fit the wall units and extractor hood before fitting the hob to avoid damaging the appliance.

► After installation, ensure that the connection cable is without hindrance and that there is no mechanical obstruction which could damage it.

All dimensions in this instruction booklet are given in mm.

► The veneer or laminate coatings of worktops (or adjacent kitchen units) must be treated with 100 °C heat-resistant adhesive which will not dissolve or distort. Any backmoulds must be of heat-resistant material.

This appliance must not be installed over a fridge, fridge-freezer, freezer, dishwasher, washing machine, washer-dryer or tumble dryer.

► This hob must not be installed above ovens or cookers unless these have a built-in cooling down fan.

# Safety distances

## Safety distance above the appliance

A minimum safety distance must be

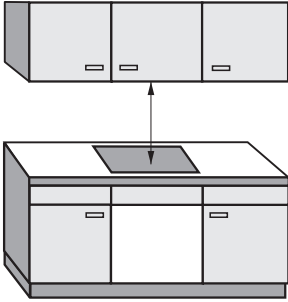

When two or more appliances which have different safety distances are installed together below a cooker hood, you should observe the greatest safety distance.

maintained between the appliance and the cooker hood above it. See the cooker hood manufacturer's operating and installation instructions for details.

If the manufacturer's instructions are not available for the cooker hood, a minimum safety distance of at least 760 mm must be maintained. For any flammable objects, e.g. utensil rails, wall units etc. a minimum distance of at least 760 mm must be maintained between them and the appliance below.

## Safety distances to the sides and back of the hob

Ideally the hob should be installed with plenty of space on either side. There may be a wall at the rear or a tall unit or wall on one side (right **or** left) (see illustrations).

- ① Minimum distance of 50 mm between the **back** of the worktop cut-out and the rear edge of the worktop.
- ② Minimum distance of 50 mm between the worktop cutout and a wall or tall unit to the **right** of it.
- ③ Minimum distance of 50 mm between the worktop cutout and a wall or tall unit to the **left** of it.

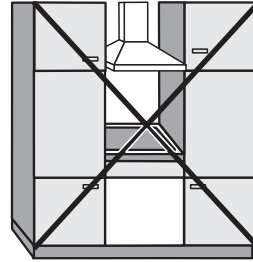

Not allowed

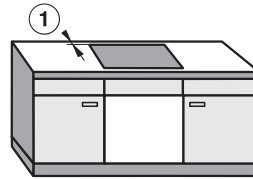
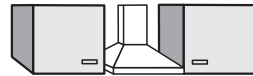

Recommended

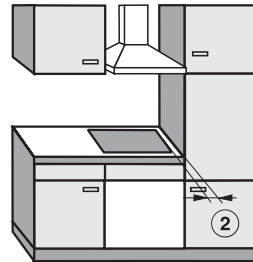

Not recommended

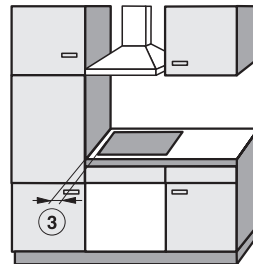

Not recommended

# Safety distances

---

## Safety distances underneath the hob

To ensure sufficient ventilation to the hob, a certain gap must be left between the underside of the hob and any oven, interim shelf or drawer.

The minimum gap between the underside of the hob and

- the top of an **oven** is **15 mm**.
- the top of an **interim shelf** is **15 mm**.
- the base of a **drawer** is **75 mm**.

## Interim shelf

It is not necessary to fit an interim shelf underneath the hob, but one may be fitted if you wish.

Leave a gap of 10 mm at the back of the shelf to accommodate the cable. We recommend a gap at the front of the shelf of 20 mm to ensure good ventilation.



## Safety distance when installing the appliance near a wall with additional niche cladding

A minimum safety distance must be maintained between the worktop cut-out and any niche cladding to protect it from heat damage.

If the niche cladding is made from a **combustible material** (e. g. wood) a minimum safety distance ⑤ of 50 mm must be maintained between the cut-out and the cladding.

If the niche cladding is made from a **non-combustible material** (e. g. metal, natural stone, ceramic tiles) a minimum safety distance ⑤ of 50 mm less the thickness of the cladding must be maintained between the cut-out and the cladding.

Example: 15 mm niche cladding

50 mm - 15 mm = minimum safety distance of 35 mm

### Flush-fitted hobs

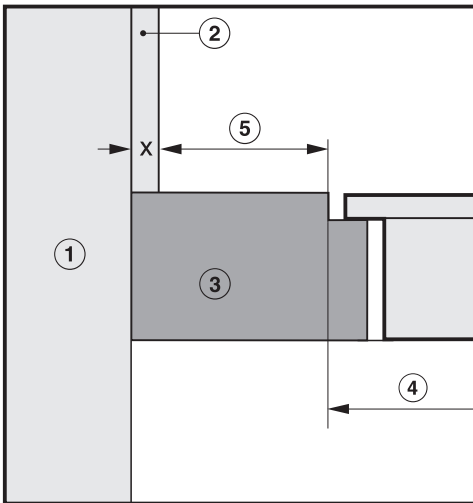

### Hob with frame or bevelled edge

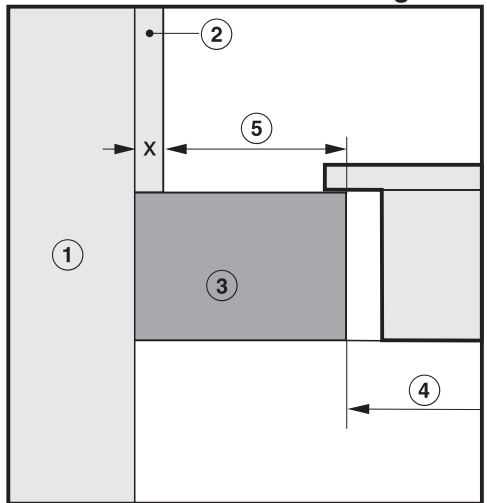

① Masonry

② Niche cladding

Dimension x = thickness of niche cladding material

③ Worktop

④ Worktop cut-out

⑤ Minimum safety distance

for **combustible** materials is 50 mm

for **non-combustible** materials is 50 mm less dimension x

# Hob with frame or bevelled edge

## Installation notes

### Seal between the hob and the worktop

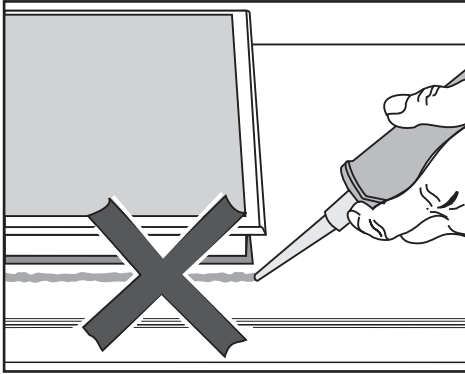

Do not use sealant between the hob and the worktop. This could result in damage to the hob or the worktop if the hob ever needs to be removed for servicing.

The sealing strip under the edge of the top part of the appliance provides a sufficient seal for the worktop.

### Tiled worktop

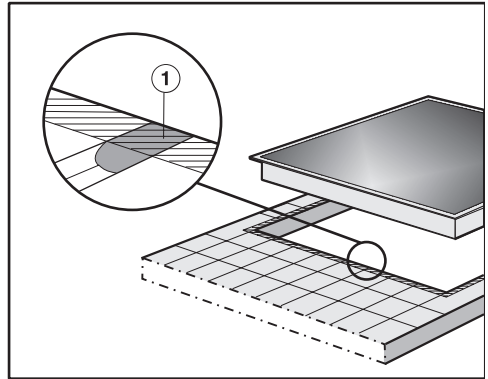

Grout lines ① and the hatched area underneath the hob frame must be smooth and even. If they are not the hob will not sit flush with the worktop and the sealing strip underneath the hob will not provide a good seal between the hob and the worktop.

# Hob with frame or bevelled edge

## Building-in dimensions

KM 6328

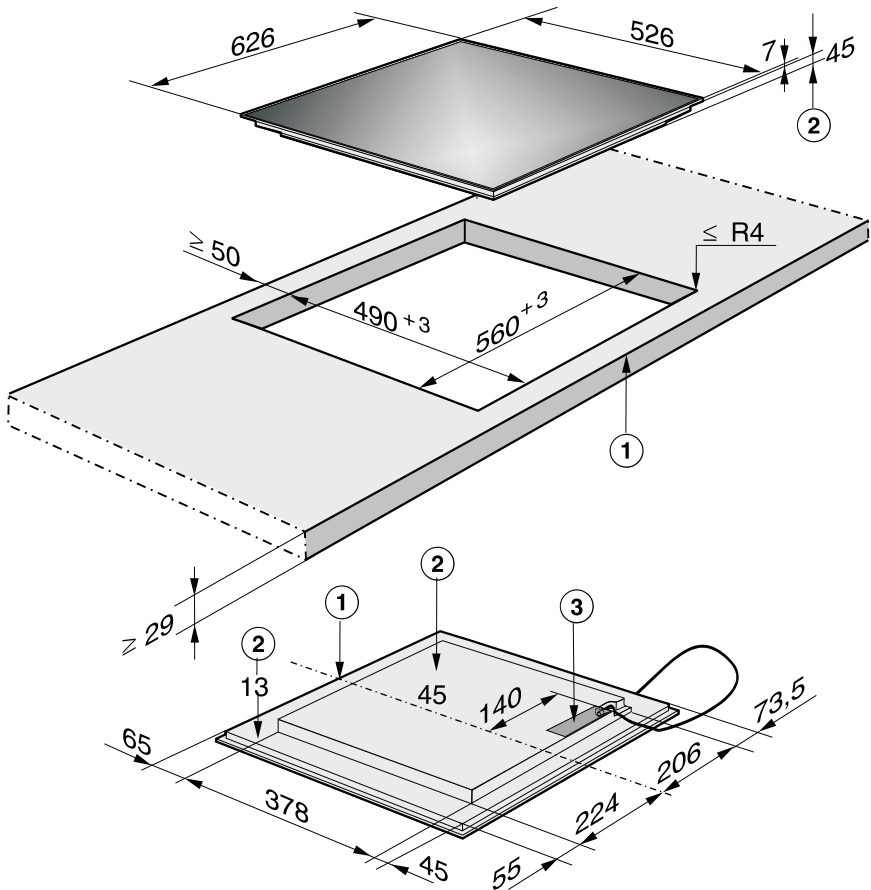

- ① Front
- ② Casing depth
- ③ Mains connection box

The mains connection cable (1440 mm long) is supplied separately.

# Hob with frame or bevelled edge

KM 6366

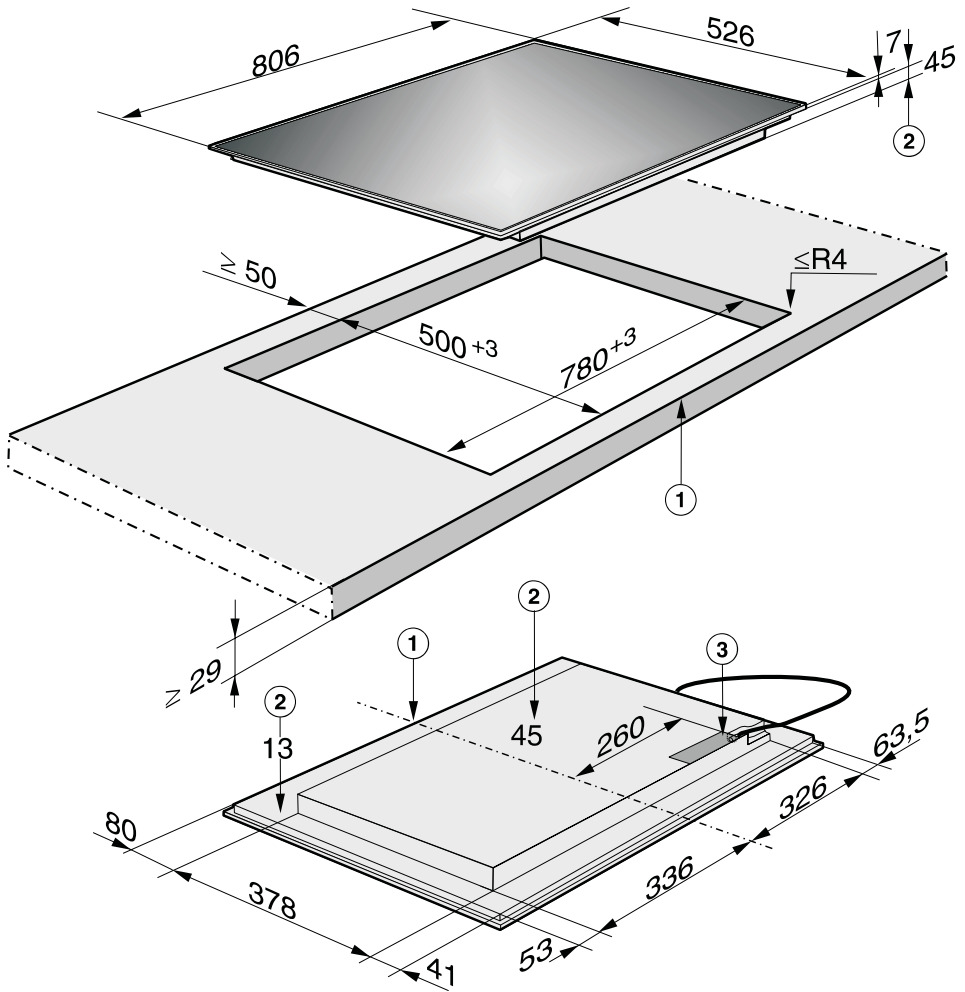

① Front

② Casing depth

③ Mains connection box

The mains connection cable (1440 mm long) is supplied separately.

# Hob with frame or bevelled edge

## Installing the hob

### Preparing the worktop

- Make the worktop cut-out according to the dimensions given in the building-in diagram. Remember to maintain the **minimum safety distances** (see "Safety instructions for installation").
- Seal the cut surfaces with a suitable heat-resistant sealant to avoid swelling caused by moisture.

Make sure that the sealant does not come into contact with the top of the worktop.

No spring clamps are needed to install the hob. The seal underneath the hob will hold it securely on the worktop.  
Any gap between the frame and worktop will reduce with time.

### Connecting the mains cable to the appliance

The mains cable must only be connected to the appliance by a qualified and competent electrician in strict accordance with current local and national safety regulations (BS 7671 in the UK).

- Follow the instructions in the wiring diagram (see "Electrical connection - Wiring diagram").

### Installing the hob

- Feed the mains connection cable down through the cut-out.
- Place the hob centrally in the cut-out. When doing this, make sure that the seal under the hob sits flush with the worktop on all sides. This is important to ensure an effective seal all round. Do not use sealant (e.g. silicone).

If the seal does not meet the worktop correctly on the corners the corner radius ( $\leq R4$ ) can be carefully scribed to suit.

- Connect the hob to the mains.
- Check that the hob works.

# Flush-fitted hobs

## Building-in dimensions

KM 6367

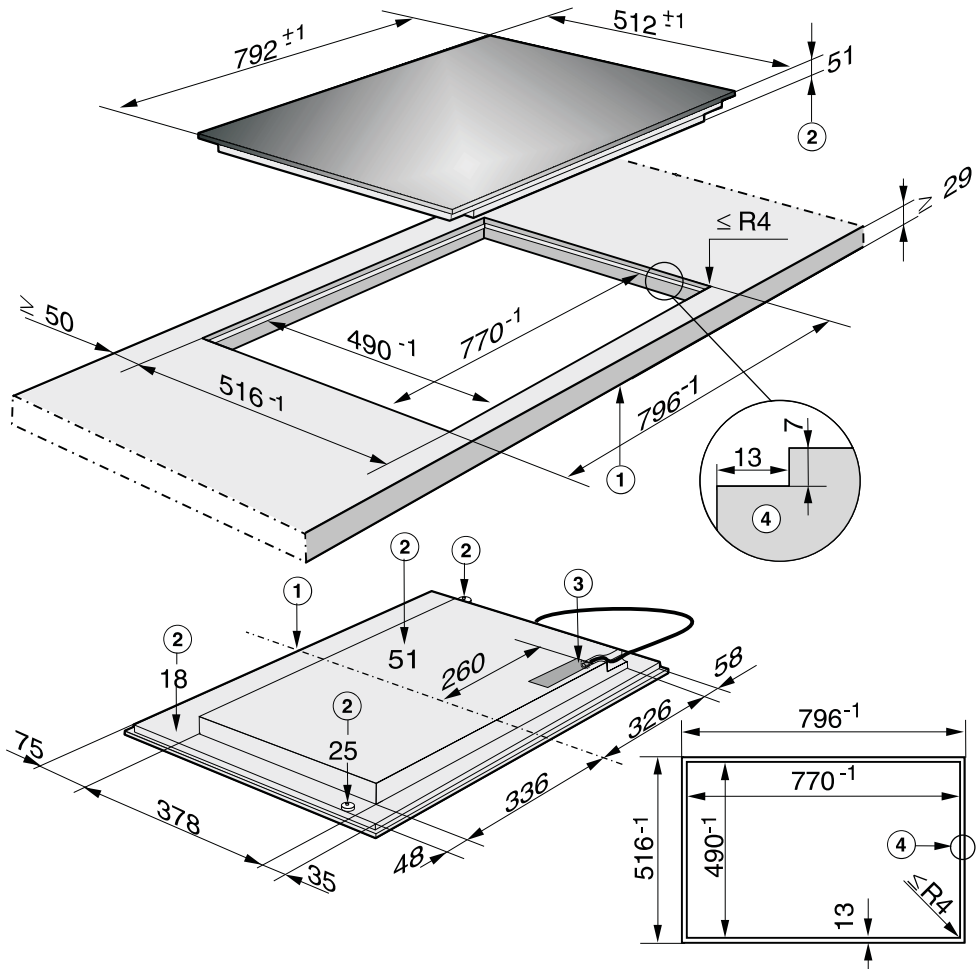

- ① Front
- ② Casing depth
- ③ Mains connection box
- ④ Stepped cut-out for granite or marble worktops

**Please take careful note of the detailed diagrams for the cut-out dimensions in granite and marble worktops.**

The mains connection cable (1440 mm long) is supplied separately.

## Installing the hob

Flush fit hobs are only suitable for installation in granite, marble, tiled or solid wood worktops.

When using a worktop made from any other material, please check first with the worktop manufacturer that it is suitable for installing a flush fit hob.

Certain models are suitable for building into glass worktops - please see advice under "Building-in dimensions".

The internal width of the base unit must be at least as wide as the internal cut-out width for the hob (see "Building-in dimensions"). This is to ensure that the casing can be easily removed for maintenance. If the underside of the hob is not freely accessible after installation, any sealant used to plug the gaps around the appliance must be removed to enable the hob to be lifted out of the cut-out should this be necessary.

The hob can be installed

- in a suitable cut-out in a granite or marble worktop.
- in a suitable cut-out in a tiled or solid wood worktop or a glass worktop with a wooden support frame. The frame must be provided on site, and is not supplied with the appliance.

# Flush-fitted hobs

## Granite and marble worktops

### Preparing the worktop

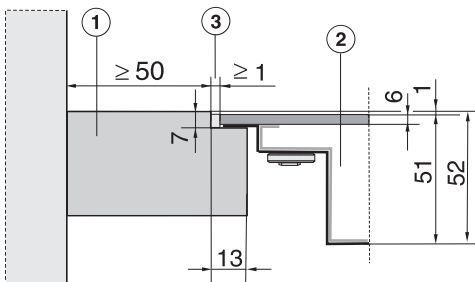

① Worktop

② Hob

③ Gap

As the ceramic glass and the worktop cut-out have a certain dimensional tolerance, the size of gap ③ can vary (min. 1 mm).

- Make the worktop cut-out as shown in "Building-in dimensions". Observe the **safety distances** (see "Safety instructions for installation").

### Connecting the mains cable to the appliance

The mains cable must only be connected to the appliance by a qualified and competent electrician in strict accordance with current local and national safety regulations (BS 7671 in the UK).

- Follow the instructions in the wiring diagram (see "Electrical connection - Wiring diagram").

### Installing the hob

- Feed the mains connection cable down through the cut-out.
- Centre the hob ② in the cut-out.
- Connect the hob to the mains.
- Check that the hob works.
- Seal the remaining gap ③ with a silicone sealant that is heat-resistant to at least 160 °C.

For granite and marble worktops, only use silicone sealant that is especially formulated for granite and marble, and observe the sealant manufacturer's instructions.



## Solid wood, tiled and glass worktops

### Preparing the worktop

#### ① Worktop

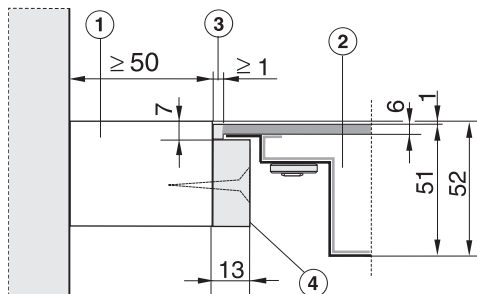

#### ② Hob

#### ③ Gap

#### ④ Wooden frame 13 mm (to be provided on site)

As the ceramic glass and the worktop cut-out have a certain dimensional tolerance, the size of gap ③ can vary (min. 1 mm).

- Make the worktop cut-out as shown in "Building-in dimensions". Observe the **safety distances** (see "Safety instructions for installation").
- Fix the wooden frame ④ 7 mm below the top edge of the worktop (see diagram).

### Connecting the mains cable to the appliance

The mains cable must only be connected to the appliance by a qualified and competent electrician in strict accordance with current local and national safety regulations (BS 7671 in the UK).

- Follow the instructions in the wiring diagram (see "Electrical connection - Wiring diagram").

### Installing the hob

- Feed the mains connection cable down through the cut-out.
- Centre the hob ② in the cut-out.
- Connect the hob to the mains.
- Check that the hob works.
- Seal the remaining gap ③ with a silicone sealant that is heat-resistant to at least 160 °C.

Observe the silicone sealant manufacturer's instructions.

For **granite and marble tiles**, only use silicone sealant that has been especially formulated for granite and marble.

## Electrical connection

---

All electrical work should be carried out by a suitably qualified and competent person, in strict accordance with current local and national safety regulations (BS 7671 in the UK).

Installation, repairs and other work by unqualified persons could be dangerous. The manufacturer cannot be held liable for unauthorised work.

A damaged cable must be replaced by a suitably qualified electrician with a special connection cable of type H 05 VV-F, available from Miele.

Ensure power is not supplied to the appliance until after installation or repair work has been carried out.

The appliance must only be operated when built-in. This is to ensure that all electrical parts are shielded. Live parts must not be exposed.

Do not connect the appliance to the mains electricity supply by an extension lead. These do not guarantee the required safety of the appliance.

Connection should be made via a suitable isolator which complies with national and local safety regulations, and the On/Off switch should be easily accessible after the appliance has been built in.

If the switch is not accessible after installation (depending on country) an additional means of disconnection must be provided for all poles.

For extra safety it is advisable to protect the appliance with a residual current device (RCD). Please contact a qualified electrician for advice.

When switched off there must be an all-pole contact gap of at least 3 mm in the isolator switch (including switch, fuses and relays).

### Important U.K.

The appliance is supplied for connection to a 230-240 V, 50 Hz supply with a 3-core cable.

The wires in the mains lead are coloured in accordance with the following code:

Green/yellow = earth

Blue = neutral

Brown = live

**WARNING**  
**THIS APPLIANCE MUST BE**  
**EARTHED**

Please make sure that the connection data quoted on the data plate match the household mains supply.

# Electrical connection

The electrical safety of this appliance can only be guaranteed when continuity is complete between it and an effective earthing system, which complies with current local and national safety regulations. It is most important that this basic safety requirement is present and regularly tested and where there is any doubt, the electrical wiring in the home should be inspected by a qualified electrician. The manufacturer cannot be held liable for the consequences of an inadequate earthing system such as an electric shock.

The manufacturer cannot be held liable for damage which is the direct or indirect result of incorrect installation or connection.

## Wiring diagram

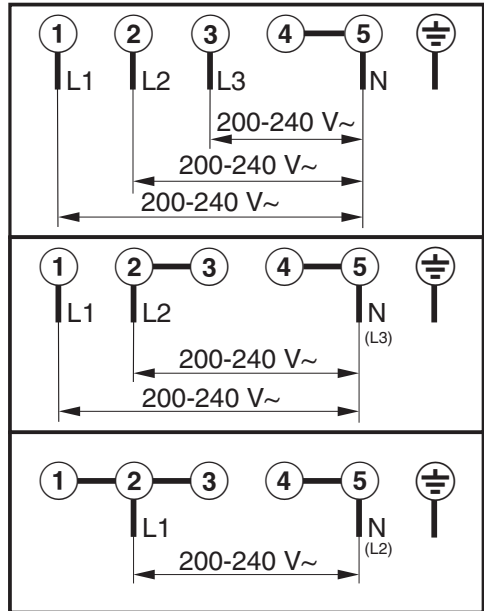

**N.B. This appliance is supplied single phase only in the U.K. / AUS / NZ**

## After sales service, data plate, guarantee

---

In the event of any faults which you cannot remedy yourself, please contact:

- your Miele dealer, or
- Miele (see back of manual for contact details).

Please note that telephone calls may be monitored and recorded for training purposes (UK only).

When contacting your Dealer or Miele, please quote the model and serial number of your appliance. These are given on the data plate.

Space in which to stick the extra data plate supplied with the appliance. Ensure that the model number is the same as the one on the back of these instructions.

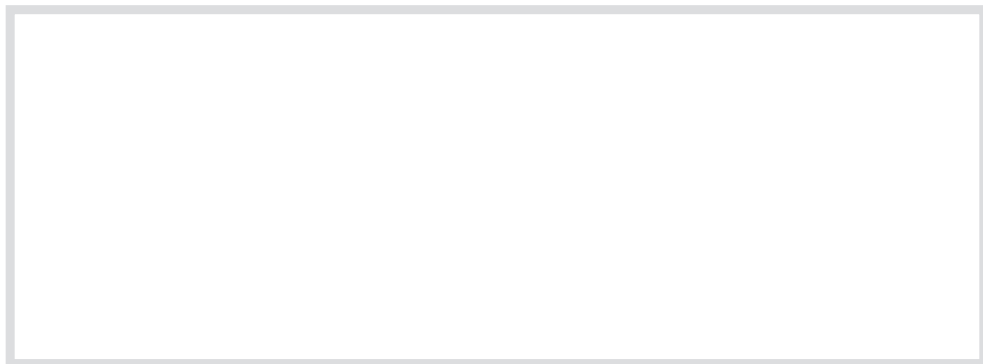

### Guarantee

For information on the appliance guarantee specific to your country please contact Miele. See back of manual for contact details. In the UK, your appliance is guaranteed for 2 years from the date of purchase. However, you must activate your cover by calling 0845 365 6640 or registering online at [www.miele.co.uk](http://www.miele.co.uk).







## United Kingdom

Miele Co. Ltd.

Fairacres, Marcham Road

Abingdon, Oxon, OX14 1TW

Tel: 0845 365 0555

Customer Contact Centre Tel: 0845 365 6600

E-mail: [info@miele.co.uk](mailto:info@miele.co.uk)

Internet: [www.miele.co.uk](http://www.miele.co.uk)

## Australia

Miele Australia Pty. Ltd.

ABN 96 005 635 398

1 Gilbert Park Drive, Knoxfield, VIC 3180

Tel: 1300 464 353, Fax: (03) 9764 7149

Internet: [www.miele.com.au](http://www.miele.com.au)

## China

Miele (Shanghai) Trading Ltd.

1-3 Floor, No. 82 Shi Men Yi Road

Jing' an District

200040 Shanghai, PRC

Tel: +86 21 6157 3500, Fax: +86 21 6157 3511

E-mail: [info@miele.cn](mailto:info@miele.cn)

Internet: [www.miele.cn](http://www.miele.cn)

## Miele (Hong Kong) Limited

41/F - 4101, Manhattan Place

23 Wang Tai Road

Kowloon Bay

Hong Kong

Tel: (852) 2610 1331, Fax: (852) 2610 1013

Email: [mielehk@miele.com.hk](mailto:mielehk@miele.com.hk)

## India

Miele India Pvt. Ltd.

Ground Floor, Copia Corporate Suites

Plot No. 9, Jasola

New Delhi - 110025

Tel: 011-46 900 000, Fax: 011-46 900 001

E-mail: [customercare@miele.in](mailto:customercare@miele.in), Internet: [www.miele.in](http://www.miele.in)

## Ireland

Miele Ireland Ltd.

2024 Bianconi Avenue

Citywest Business Campus, Dublin 24

Tel: (01) 461 07 10, Fax: (01) 461 07 97

E-Mail: [info@miele.ie](mailto:info@miele.ie), Internet: [www.miele.ie](http://www.miele.ie)

**Manufacturer:** Miele & Cie. KG

Carl-Miele-Straße 29, 33332 Gütersloh, Germany

## Malaysia

Miele Sdn Bhd

Suite 12-2, Level 12

Menara SapuraKencana Petroleum

Solaris Dutamas No. 1, Jalan Dutamas 1

50480 Kuala Lumpur, Malaysia

Phone: +603-6209-0288

Fax: +603-6205-3768

## New Zealand

Miele New Zealand Limited

8 College Hill

Freemans Bay, Auckland 1011, NZ

Tel: 0800 264 353, Fax: 0800 463 453

Internet: [www.miele.co.nz](http://www.miele.co.nz)

## Singapore

Miele Southeast Asia

Miele Pte. Ltd.

163 Penang Road

# 04 - 02/03 Winsland House II

Singapore 238463

Tel: +65 6735 1191, Fax: +65 6735 1161

E-Mail: [infosea@miele.com.sg](mailto:infosea@miele.com.sg)

Internet: [www.miele.sg](http://www.miele.sg)

## South Africa

Miele (Pty) Ltd

63 Peter Place, Bryanston 2194

P.O. Box 69434, Bryanston 2021

Tel: (011) 875 9000, Fax: (011) 875 9035

E-mail: [info@miele.co.za](mailto:info@miele.co.za)

Internet: [www.miele.co.za](http://www.miele.co.za)

## United Arab Emirates

Miele Appliances Ltd.

P.O. Box 11 47 82

Gold & Diamond Park

Sheikh Zayed Road

Building 6 / Offices Nos. 6-214 to 6-220

Dubai

Tel: +971-4-341 84 44

Fax: +971-4-341 88 52

E-Mail: [info@miele.ae](mailto:info@miele.ae), Internet: [www.miele.ae](http://www.miele.ae)

KM 6328 / KM 6366 / KM 6367



en - GB

M.-Nr. 09 524 050 / 03