

COBY®

MP-C7057



**Mini MP3/Video Player with FM Radio and
Integrated Stereo Speakers**



INSTRUCTION MANUAL

Please read this manual carefully before operation.

PRECAUTIONS

| | | |
|--|---|---|
|  | CAUTION WARNING: SHOCK HAZARD, DO NOT OPEN. AVIS: RISQUE DE CHOC ELECTRIQUE. NE PAS OUVRIIR |  |
| CAUTION: TO REDUCE THE RISK OF FIRE AND ELECTRIC SHOCK, DO NOT REMOVE THE COVER (OR BACK) OF THE UNIT. REFER SERVICING ONLY TO QUALIFIED SERVICE PERSONNEL. | | |



The lightning flash with arrowhead symbol within an equilateral triangle is intended to alert the user to the presence of uninsulated "dangerous voltage" within the product's enclosure that may be of sufficient magnitude to constitute a risk of electric shock.



The exclamation point within an equilateral triangle is intended to alert the user to the presence of important operation and servicing instructions in the literature accompanying the appliance.

For Customer Use:

Enter below the serial number that is located on the unit. Retain this information for future reference.

Model No. _____ MP-C7057 _____

Serial No. _____

WARNING:

To prevent fire or shock hazard, do not expose this device to rain or moisture. Dangerous high voltage is present inside the enclosure. Do not open the cabinet.

CAUTION:

To prevent electric shock, match wide blade of plug to wide slot of outlet and fully insert.

WARNING:

Handling the cords on this product will expose you to lead, a chemical known to the State of California to cause cancer, and birth defects or other reproductive harm. **Wash hands after handling.**



For recycling or disposal information about this product, please contact your local authorities or the Electronics Industries Alliance: www.eiae.org.

PRECAUTIONS

PROTECT YOUR HEARING:

Hearing experts advise against the constant use of personal stereos played at high volume. Constant exposure to high volumes can lead to hearing loss. If you should experience ringing in the ears or hearing loss, discontinue use and seek medical advice.

NOTICE:

This product is protected by certain intellectual property rights of Microsoft. Use or distribution of such technology outside of this product is prohibited without a license from Microsoft.

NOTICE:

Please refer to the packaging for this product for the technologies supported by this product.

Windows Media® is a registered trademark of Microsoft Corporation.

USB® is a registered trademark of USB Implementers Forum, Inc.

The eMusic name and logo are trademarks of eMusic.com, Inc. in the United States and abroad.

All trademarks, registered trademarks and logos are of their respective holders.

IMPORTANT SAFETY INSTRUCTIONS

- 1. Read Instructions:** All the safety and operating instructions should be read before the product is operated.
- 2. Retain Instructions:** The safety and operating instructions should be retained for future reference.
- 3. Heed Warnings:** All warnings on the product and in the operating instructions should be adhered to.
- 4. Follow Instructions:** All operating and usage instructions should be followed.
- 5. Cleaning:** Unplug this product from the wall outlet before cleaning. Do not use liquid cleaners or aerosol cleaners. Use a damp cloth for cleaning.
- 6. Attachments:** Use only attachments recommended by the manufacturer. Use of other attachments may be hazardous.
- 7. Water and Moisture:** Do not use this product near water (e.g., near a bath tub, washbowl, kitchen sink, laundry tub, in wet basements, or near a swimming pool and the like).
- 8. Accessories:** Do not place this product on an unstable cart, stand, tripod, bracket, or table. Use only with carts, stands, tripods, brackets, or tables recommended by the manufacturer or sold with the product. Any mounting of the product should follow the manufacturer's instructions and should use a mounting accessory recommended by the manufacturer.
- 9.** A product and cart combination should be moved with care. Quick stops, excessive force, and uneven surfaces may cause the product and cart combination to overturn.
- 10. Ventilation:** Slots and openings in the cabinet are provided for ventilation to ensure reliable operation of the product and to protect it from overheating. These openings should never be blocked by placing the product on a bed, sofa, rug, or other similar surface. This product should not be placed in a built-in installation such as a bookcase or rack unless proper ventilation is provided or the manufacturer instructions have been adhered to.
- 11. Power Sources:** This product should be operated only from the type of power source indicated on the rating label. If you are not sure of the type of power supply to your home, consult your product dealer or local power company. For products intended to operate from battery power or other sources, refer to the operating instructions.
- 12. Grounding or Polarization:** This product may be equipped with a polarized alternating-current line plug that has one blade wider than the other. This plug will only fit into the power outlet in one direction. This is a safety feature. If you are unable to insert the plug fully into the outlet, try reversing the direction of the plug. If the plug should still fail to fit, contact an electrician to replace the obsolete outlet. Do not defeat the safety purpose of the polarized plug.



IMPORTANT SAFETY INSTRUCTIONS

- 13. Power-Cord Protection:** Power supply cords should be routed so that they are not likely to be walked on or pinched by items placed upon or against them, paying particular attention to cords at plugs, convenience receptacles, and at the point which they exit from the product.
- 14. Protective Attachment Plug:** The product may be equipped with an attachment plug with overload protection. This is a safety feature. See the operating instructions for replacement or directions to reset the protective device. If replacement of the plug is required, be sure the service technician has used a replacement plug that has the same overload protection as the original plug as specified by the manufacturer.
- 15. Outdoor Antenna Grounding:** If an outside antenna is connected to the product, be sure the antenna system is grounded so as to provide some protection against voltage surges and built-up static charges. Article 810 of the National Electrical Code, ANS/NFPA 70 provides information with regard to proper grounding of the mast and supporting structure, grounding of the lead-in wire to an antenna-discharge unit, size of grounding conductors, location of antenna-discharge unit, connection to grounding electrodes, and requirements for the grounding electrode (see figure).

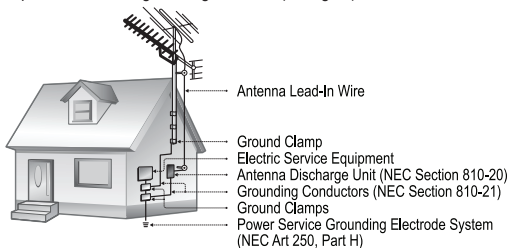

- 16. Lightning:** For added protection for this product, unplug it from the wall outlet and disconnect the antenna or cable system during a lightning storm or when it is left unattended and unused for long periods of time. This will prevent damage to the product due to lightning or power-line surges.
- 17. Power Lines:** An outside antenna system should not be located in the vicinity of overhead power lines or other electric light or power circuits, or where it can fall into such power lines or circuits. When installing an outside antenna system, extreme care should be taken to keep from touching such power lines or circuits, as contact with them might be fatal.
- 18. Overloading:** Do not overload wall outlets, extension cords, or integral convenience receptacles as this can result in a risk of fire or electric shock.

IMPORTANT SAFETY INSTRUCTIONS

19. **Object and Liquid Entry:** Never push objects of any kind into this product through openings as they may touch dangerous voltage points or shout-out parts that could result in a fire or electric shock. Never spill liquid of any kind on the product.
20. **Servicing:** Do not attempt to service this product yourself as opening or removing covers may expose you to dangerous voltage or other hazards. Refer all servicing to qualified service personnel.
21. **Damage Requiring Service:** Unplug this product from the wall outlet and refer servicing to qualified service personnel under the following conditions: a) when the power-supply or plug is damaged; b) if liquid has been spilled or if objects have fallen into the product; c) if the product has been exposed to rain or water; d) if the product does not operate normally by following the operating instructions. Adjust only those controls that are covered by the operating instructions as improper adjustment of other controls may result in damage and will often require extensive work by a qualified technician to restore the product to its normal operation; e) if the product has been dropped or damaged in any way; f) when the product exhibits a distinct change in performance—this indicates a need for service.
22. **Replacement Parts:** When replacement parts are required, be sure that your service technician has used replacement parts specified by the manufacturer or have the same characteristics as the original part. Unauthorized substitutions may result in fire, electric shock, or other hazards.
23. **Safety Check:** Upon completion of any service or repairs to this product, ask the service technician to perform safety checks to ensure that the product is in proper operating condition.
24. **Wall or Ceiling Mounting:** The product should be mounted to a wall or ceiling only as recommended by the manufacturer.
25. **Heat:** The product should be situated away from heat sources such as radiators, heat registers, stoves, or other products (including amplifiers) that produce heat.

TABLE OF CONTENTS

| | |
|--|-----------|
| PRECAUTIONS | 2 |
| IMPORTANT SAFETY INSTRUCTIONS | 4 |
| TABLE OF CONTENTS | 7 |
| PACKAGE CONTENTS | 10 |
| FEATURES | 11 |
| GETTING STARTED | 12 |
| MP-C7057 at a Glance..... | 12 |
| Front View | 12 |
| Rear View | 12 |
| Left View | 13 |
| Right View | 13 |
| Top View | 13 |
| Bottom View | 13 |
| Display at a Glance..... | 14 |
| Music Mode Screen (Play) | 14 |
| Record Mode Screen | 14 |
| Connecting Headphones | 15 |
| Using the Integrated Speakers | 15 |
| Connecting Power..... | 15 |
| Power On/Off | 16 |
| Hold Switch..... | 17 |
| Reset Function | 17 |
| MAIN MENU | 18 |
| Main Menu Overview..... | 18 |
| MUSIC MODE | 19 |
| Music List..... | 19 |
| Music Mode Controls..... | 19 |
| Repeat A-B Mode | 20 |
| Play Mode | 20 |
| VIDEO MODE | 22 |
| Video List | 22 |
| Video Controls..... | 22 |

TABLE OF CONTENTS

| | |
|--|-----------|
| PHOTO MODE | 23 |
| Photo List..... | 23 |
| Photo Controls | 23 |
| Displaying Pictures Manually..... | 23 |
| Displaying Pictures as a Slideshow | 24 |
| FM RADIO MODE | 25 |
| Basic FM Radio Operation..... | 25 |
| Store Preset Stations..... | 25 |
| Store Presets Manually | 25 |
| Store Presets Automatically..... | 26 |
| Delete a Preset Station..... | 26 |
| FM Radio Recording | 26 |
| RECORD MODE | 28 |
| Line-in Recording..... | 28 |
| Microphone (Voice) Recording | 28 |
| RECORD MODE | 29 |
| EBOOK MODE | 30 |
| EBook List | 30 |
| EBook Controls..... | 30 |
| NAVIGATOR MODE | 31 |
| Navigator Controls..... | 31 |
| SETUP MODE | 32 |
| DELETE MODE | 34 |
| Delete Controls..... | 34 |
| USB CONNECTIONS | 35 |
| USB Driver Installation (Windows 98SE Only)..... | 35 |
| Connecting to a Computer | 35 |
| Transferring Files | 37 |
| Microsoft Windows | 38 |
| Macintosh OS X | 38 |

TABLE OF CONTENTS

| | |
|---------------------------------------|-----------|
| Disconnecting from a Computer | 39 |
| Microsoft Windows | 39 |
| Macintosh OS X | 39 |
| VIDEO CONVERSION | 41 |
| Installation | 42 |
| Converting Video | 42 |
| WINDOWS MEDIA PLAYER..... | 43 |
| FIRMWARE UPGRADES..... | 44 |
| ABOUT MP3/WMA MUSIC FILES..... | 46 |
| TROUBLESHOOTING..... | 47 |
| SPECIFICATIONS | 50 |

PACKAGE CONTENTS

Please make sure that the items listed below are included in the package. Should an item be missing, please contact the local retailer from which you purchased this product.

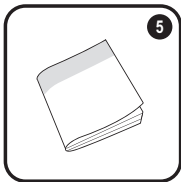
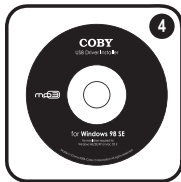
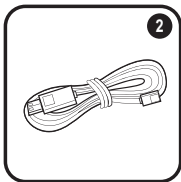

1. MP-C7057
2. USB Cable
3. Stereo Earphones
4. Installation CD
5. Installation Booklet

FEATURES





- ✦ 512MB Integrated Flash Memory
- ✦ 1.5" CSTN Full-Color Display
- ✦ Integrated Stereo Speakers
- ✦ Plays Music, Video, Photos, and Text
- ✦ Plays Digital Music from most online stores and subscription services*
- ✦ Line-In Jack for Recording from Audio Sources
- ✦ ID3 and LRC support for song and synchronized lyric information display
- ✦ Integrated FM Radio and Recorder
- ✦ Integrated Microphone for Digital Voice Recording
- ✦ Mobile Data Storage Function
- ✦ USB 2.0 for Ultra-Fast File Transfers (up to 40x faster than USB 1.0)

* Music Service must support Windows Media DRM (WMDRM). WMDRM10 requires Windows XP and Windows Media Player 10 or newer.

GETTING STARTED

MP-C7057 at a Glance

Front View

1. LCD Display
2. Navigation: Up
Volume + 
3. Navigation: Left
Prev/Rev 
4. Navigation: Down
Volume - 
5. Navigation: Right
Next/Fwd 

6. Navigation: Enter
Press Joystick 
7. Power Indicator

Rear View

8. Reset Button

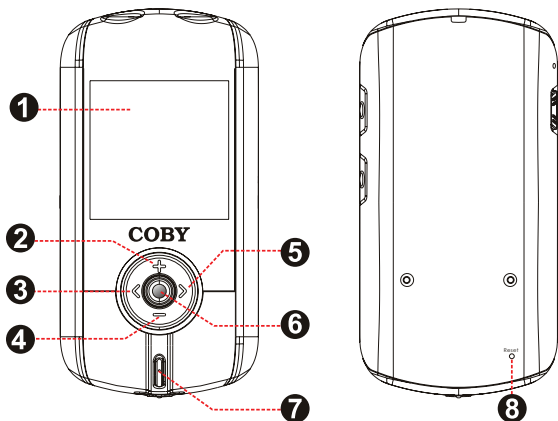



GETTING STARTED

Left View

- 9. Microphone
- 10. HOLD Switch

Right View

- 11. Power Play/Pause 
- 12. Record Repeat A-B 

Top View

- 13. Neckstrap Hook
- 14. Line In (Record)
- 15. Headphone Out

Bottom View

- 16. USB Port

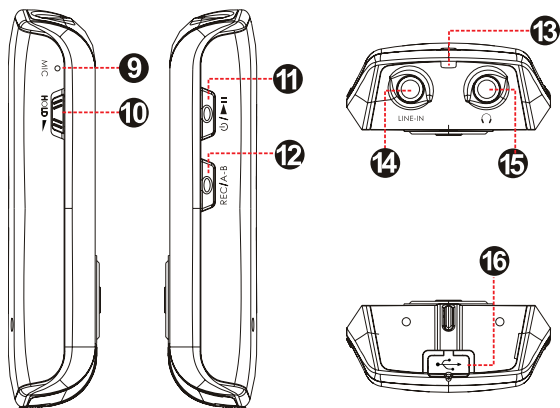

GETTING STARTED

Display at a Glance

Music Mode Screen (Play)

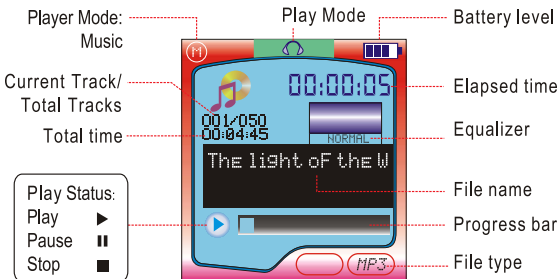

Record Mode Screen

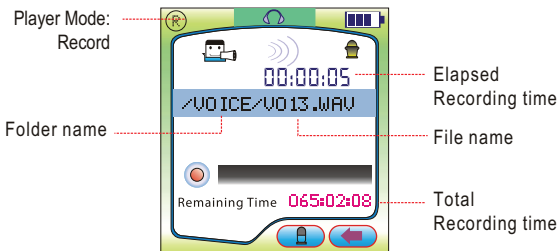

GETTING STARTED

Connecting Headphones

Connect headphones/earphones to the Headphone Out jack for private listening.

When headphones are connected, audio output from the integrated speakers will be stopped automatically.



Lower the volume level before connecting headphones, then gradually increase the volume for comfortable listening.

Hearing experts advise against the constant use of personal stereos played at high volume.

Constant high-volume use can lead to hearing loss. If you experience ringing in your ears or hearing loss, discontinue use immediately and seek medical advice.

Using the Integrated Speakers

Disconnect any headphones or earphones from the Headphone Out jack to output audio from the integrated speakers.

Connecting Power

Your player has an integrated rechargeable battery that will provide up to 5 hours of music play time.



The battery should be charged fully (minimum 4 hours) before its initial use to ensure optimum life-time performance.

GETTING STARTED

There are two ways to charge your player.

- ✦ Charge through your computer's USB Port: Your player can be charged through a PC USB connection. Plug one end of the USB cable into the player's USB Port and plug the other end into the USB port of a powered-on computer.
 - ◇ When connected to a USB hub, the hub must be self-powered to charge the player's battery.
 - ◇ File transfers will extend the charge time.
- ✦ Charge through a AC Adapter: Plug one end of the supplied power adapter into the player's USB Port and plug the other end into a 100-240V wall outlet.





The battery used in this device may present a fire or chemical burn if mistreated. Do not disassemble, incinerate, or heat the battery.

Do not connect the player to a power source other than that which is indicated here or on the label as this may result in the risk of fire or electric shock.

Do not handle the power plug with wet hands. Doing so may cause electric shock.

Use only AC adapter of the type specified here. Failure to do so may cause a fire or damage the player.

Power On/Off

- ✦ To turn the player on, press and hold .
- ✦ To turn the player off, press and hold .

GETTING STARTED

Hold Switch

The Hold feature locks (disables) your player's controls to prevent accidental key presses when it is in your pocket or bag.

- ✦ To lock the player, slide the HOLD switch down to the lock position. A lock icon will appear on-screen.



- ✦ To unlock the player, slide the HOLD switch up.

Reset Function

You may reset your player if it should freeze or otherwise behave abnormally.

1. Disconnect your player if it is connected to a computer.
2. Use a pin to press the RESET key located on the rear of the player.

MAIN MENU

Main Menu Overview

The Main Menu gives you access to the different function modes of your player. When your player is powered on, it will enter the Main Menu automatically.

The main menu consists of 9 items: Music, Video, Photo, FM Radio, Line-In Record, Ebook, Navigator, Setup, and Delete.

- ✦ To return to the Main Menu at any time, press and hold **OK**.
- ✦ To select a mode, press **+** or **-** to highlight the mode and then press **OK**.



MUSIC MODE

Enter MUSIC mode from the Main Menu to play digital MP3 ,WMA or WAV audio files.

MUSIC mode will play all compatible audio files on your player, regardless of directory.

Music List

Use the Music List to view all audio tracks loaded on your player. Press **OK** to view the Music List.

- ✦ Press **+** to move the selection up; press **-** to move the selection down.
- ✦ Press **OK** or **⏮/▶** to confirm and play a selection.
- ✦ Press and hold **OK** to cancel and return to the Main Menu.

Music Mode Controls

Use the following controls during music playback.

| Key | Function |
|-------------------------|--|
| Press ⏮/▶ | Start/Resume track playback. During playback, press ⏮/▶ to pause playback. |
| Hold ⏮/▶ (2 sec) | Stop track playback completely. |
| Press > | Play the next track. |
| Hold > | Fast-forward through the current track. |
| Press < | Play the previous track. |
| Hold < | Reverse through the current track. |

MUSIC MODE

| Key | Function |
|----------------|----------------------------|
| Press - | Decrease the volume level. |
| Press + | Increase the volume level. |
| Hold OK | Return to Main Menu. |



For more information about how to get music onto your player, please refer to the section “USB Connections > Transferring Files”.

For more information about digital MP3 and WMA music files, please refer to the section “About MP3/WMA Music Files”.

Repeat A-B Mode

Set a segment of a music track to repeat in a continuous loop. During playback:

- ✦ To set the starting point “A” of the loop, press **REC/A-B**.
- ✦ To set the end point “B” of the loop, press **REC/A-B** again. The loop will now play from point “A” to point “B”.
- ✦ To resume normal playback, press **REC/A-B** again.

Play Mode

Adjust the Play Mode settings to change the order in which tracks are played. The Play Mode options are: Normal, Repeat One, Repeat All, Shuffle Repeat, and Intro.

MUSIC MODE

| Item | Description |
|----------------|--|
| Normal | Play tracks once in sequential order. |
| Repeat One | Play the current track repeatedly. |
| Repeat All | Play all tracks repeatedly. |
| Shuffle Repeat | Play tracks in random order. |
| Intro | Play the first 10 seconds of each track. |



The Play Mode options may also be changed in the SETUP menu.

VIDEO MODE

Enter VIDEO mode to play SMV video files loaded on your player.

Video List

Use the Video List to view all video tracks loaded on your player. Press **OK** while in VIDEO mode to view the Video List.

- ✦ Press **+** to move the selection up; press **-** to move the selection down.
- ✦ Press **⏮/▶** or **OK** to confirm and play a selection.
- ✦ Press and hold **OK** to cancel and return to the Main Menu.

Video Controls

Use the following controls during video playback.

| Key | Function |
|-------------------------|--|
| Press ⏮/▶ | Start/Resume track playback. During playback, press ⏮/▶ to pause playback. |
| Hold ⏮/▶ (2 sec) | Stop track playback completely. |
| Press > | Play the next track. |
| Hold > | Fast-forward through the current track. |
| Press < | Play the previous track. |
| Hold < | Reverse through the current track. |
| Press - | Decrease the volume level. |
| Press + | Increase the volume level. |
| Hold OK | Return to Main Menu. |

PHOTO MODE

Enter PHOTO mode from the Main Menu to find and play picture files (JPEG, BMP) loaded on your player.

Photo List

Use the Photo List view all picture files loaded on your player. Press **OK** while in PHOTO mode to view the Photo List.

- ✦ Press **+** to move the selection up; press **-** to move the selection down.
- ✦ Press **⏪/▶** or **OK** to confirm and display a selection.
- ✦ Press and hold **OK** to cancel and return to the Main Menu.

Photo Controls





The viewer can display photos with manual control or as a slideshow (photos are automatically displayed in sequence).

Displaying Pictures Manually

- ✦ To display a picture, select it from the Photo List and press **⏪/▶** or **OK** to confirm.
- ✦ Press **>** to skip to the next picture; press **<** to skip to the previous picture.
- ✦ Press **+** to increase the magnification of a picture; press **-** to decrease the magnification of a picture.
 - ✧ Use the joystick to pan around an enlarged picture.

PHOTO MODE

Displaying Pictures as a Slideshow

- ✦ Select a photo from the Photo List and press  or  to confirm.
- ✦ Press  to start the slideshow. Press  again to stop the slideshow.
- ✦ Press  to cancel the slideshow and return to the Photo List.

FM RADIO MODE







Enter FM Radio Mode to listen to FM radio broadcasts.



You must have a pair of headphones connected to the headphone jack to receive FM broadcasts; your player will utilize the headphone cord as an antenna.

Basic FM Radio Operation

Upon entering FM Radio mode, you can tune to stations manually (SEEK) or to preset stations (LISTEN). Press  to change between these two modes.



- ✦ **SEEK:** Press  or  to tune to stations manually. To auto-seek to the next available broadcast station, press and hold  or .
- ✦ **LISTEN:** Press  or  to tune to the next Preset Station. You must save Preset Stations prior to using this tuning method.

Store Preset Stations

Your player can store up to 25 station presets (01 to 25).

Store Presets Manually

Make sure that the player is in SEEK mode.

1. Tune to the station you want to store as a preset (e.g., 91.5).
2. Press and hold —the LCD will display “Save”.
3. Press  or  to select the desired Preset number (e.g., 01).

FM RADIO MODE

4. Press **OK** to confirm and store the station (e.g., Preset 01 is now set to the station 91.5). The LCD will display "Saved Station".

Store Presets Automatically

Make sure that the player is in LISTEN mode.

- ✦ Press and hold **⏪/⏩**. The player will automatically seek and store the first 25 frequencies with a broadcast signal.



This will overwrite all previously stored preset stations.

Delete a Preset Station

Make sure that the player is in LISTEN mode.

1. Tune to the preset station you want to delete.
2. Press and hold **OK** to delete the preset. The LCD will display "Deleted Station".



*To return to the Main Menu from LISTEN mode, press **OK** once.*

FM Radio Recording

Make digital recordings of FM radio broadcasts.

1. Tune to the FM radio broadcast you wish to record.
2. Press and hold **REC/A-B** to start FM Recording. During recording:
 - ✦ Press **⏪/⏩** to pause recording; press **⏪/⏩** again to resume recording.

FM RADIO MODE



- ✧ Press **REC/A-B** to stop and save the recording. The recorded file will be saved to the folder “FM/” and named “FXXX.WAV” where XXX corresponds to the numerical sequence in which the recording was made (numbering starts from 001).

RECORD MODE

Enter RECORD mode from the Main Menu to record sounds from external audio sources. Your player can record from three types of sources: Line-In, Microphone, or FM Radio. (See the Setup Mode section for details about changing the player's recording options.)

Line-in Recording

Make recordings from an external device through the Line-In jack located on the top of your player.

1. Connect the external device to the Line-in jack using a 3.5mm male-to-male stereo cable.
2. Enter LINE-IN RECORD mode from the Main Menu. The player will start recording from the Line-in jack.
 - ✧ Press  to pause recording; press  again to resume recording.
 - ✧ Press  to stop and save the recording. The recorded file will be saved to the folder "LINE/" and named "LINEXXX.WAV" where XXX corresponds to the numerical sequence in which the recording was made (numbering starts from 001).

Microphone (Voice) Recording

Make voice recordings through the integrated microphone located on the top of your player.

1. Enter MUSIC mode and then stop or pause music playback (see the Music Mode section for details).

RECORD MODE

2. Press and hold **REC/A-B** to enter MICROPHONE RECORD mode. The player will start recording from the microphone.
3. Press **⏏/▶** to pause recording; press **⏏/▶** again to resume recording.
4. Press **REC/A-B** to stop and save the recording. The recorded file will be saved to the folder "VOICE/" and named "VOICEXXX.WAV" where XXX corresponds to the numerical sequence in which the recording was made (numbering starts from 001).

EBOOK MODE

Enter EBOOK mode from the Main Menu to play text files (TXT) loaded on your player.

EBook List

Use the EBook List to view all text files loaded on your player. Press **OK** while in EBOOK Mode to view the EBook List.

- ✦ Press **+** to move the selection up; press **-** to move the selection down.
- ✦ Press **⏮/⏭** or **OK** to confirm and play a selection.
- ✦ Press and hold **OK** to cancel and return to the Main Menu.

EBook Controls

- ✦ To display a text file, select and confirm the file from the EBook List.
- ✦ Press **>** or **+** to skip to the next page.
- ✦ Press **<** or **-** to skip to the previous page.
- ✦ Press **OK** to return to the EBook List.
- ✦ Press and hold **OK** to cancel and return to the Main Menu.

NAVIGATOR MODE

Enter NAVIGATOR mode to browse all folders and files loaded on your player. If a compatible file is selected and confirmed, the file will be played in its corresponding mode.

- ✦ Music Mode: MP3, WMA, WAV
- ✦ Video Mode: SMV
- ✦ Photo Mode: JPEG, BMP
- ✦ EBook Mode: TXT

Navigator Controls

- ✦ Press **+** to move the selection up; press **-** to move the selection down.
- ✦ Press **OK** to confirm a selection.
 - ◇ If a folder has been selected, the contents of the folder will be displayed.
 - ◇ If a compatible file has been selected, the file will be played in its corresponding mode.
- ✦ Press **REC/A-B** to cancel a screen and return to the previous folder.
- ✦ Press and hold **OK** to return to the Main Menu.

SETUP MODE

Enter *SETUP* mode from the Main Menu to change your player's internal option settings.

- ✦ To select an option, press **+** or **-**. To confirm and enter, press **OK**.
- ✦ To exit the Setup Menu, press and hold **OK**.

The Setup Menu contains 9 options.

| Item | Description |
|-----------|--|
| Play Mode | Set a Play Mode option. The options are Normal, Repeat One, Repeat All, Shuffle Repeat, and Preview. |
| Equalizer | Set a digital equalizer preset. The options are Normal, Pop, Rock, Classic, Jazz, and Bass. |
| Contrast | Set the contrast level of the display. |
| Display | Set the Display option to change the duration of time (in seconds) that the backlight will remain on after a key press. A setting of "Always" will keep the backlight on continuously. |
| Power | Set the Power Set option to change the duration of time (in minutes) that the player will remain on when it is idle. A setting of "Disable" will turn this power saving feature off. |

SETUP MODE

| Item | Description |
|-----------------|--|
| Record Settings | <p>Set the Recording Quality level for each recording source. The Rate options are: Normal, Middle, and High. Higher quality recordings will take up more memory than lower quality recordings.</p> <ul style="list-style-type: none">• Use the Joystick to change which field is highlighted (“Sou” or “Rate”).<ul style="list-style-type: none">• While “Sou” is highlighted, press OK to cycle through the Source options (Line-In, Microphone, and FM Radio).• While “Rate” is highlighted, press OK to cycle through the Rate options (Normal, Middle, and High).• Select and confirm “Exit” when you are finished to save the Record Settings (or press REC/A-B to cancel). |
| Language | Set the Language that the menus appear in. |
| Version | View your player’s firmware information. |
| Info | View your player’s memory information. |
| USB Mode | Set the USB mode to MSC or MTP. For more information on USB modes, see the “Connecting to a Computer” section of this manual. |

DELETE MODE









Enter DELETE mode to delete files on your player.

You can also connect your player to a computer to easily manage your file library.

Delete Controls

Upon entering DELETE mode from the Main Menu, select the type of file you wish to delete (Music, Movie, Photo, or E-Book).

Use the following controls in DELETE mode.

| Key | Function |
|--|---|
| Press  | Select the next file or folder (down). |
| Press  | Select the previous file or folder (up). |
| Press  | <ul style="list-style-type: none">• If a folder is selected, the folder's contents will be displayed.• If a file is selected, the file will be marked for deletion []. Press  again to unmark the file.<ul style="list-style-type: none">• Multiple files may be selected and marked for deletion.• After you have selected and marked files for deletion, press  to delete them. The player will ask you to confirm deletion, select "Yes" or "No" and then press to confirm. |
| Press  | Return to a previous folder. |
| Press and hold  | Return to Main Menu. |

USB CONNECTIONS

Connect the MP-C7057 to a computer with the USB 2.0 cable provided to:

- ✦ Transfer files to and from your player.
- ✦ Perform basic file management functions.

USB Driver Installation (Windows 98SE Only)

It is not necessary to install the USB driver if your computer is running Microsoft Windows ME/2000/XP or newer, or Macintosh OS X. Computers running these operating systems will recognize your player automatically when connected.

If your computer is running Windows 98 SE, download the driver from COBY website: www.cobyusa.com.

Connecting to a Computer

Connect the player to your computer with the supplied USB cable.

Upon connection:

- ✦ Your computer will automatically recognize the player as an MTP Device. An icon representing your player will appear under “Audio Devices” when you open “My Computer”.
- ✦ It may take Windows several minutes to recognize and set up the device the first time it is connected depending on your hardware configuration.

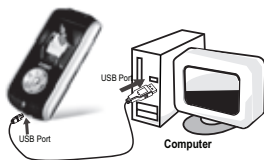

USB CONNECTIONS



For more information and support regarding music transfer and synchronization with Windows Media Player (WMP), please see the help section including with WMP (Click Help > Synchronizing Content to Devices).

USB CONNECTIONS

Transferring Files

The USB 2.0 connection makes it easy to transfer music files (or any other data files) quickly between the player and your computer. Simply use the player as you would a floppy disk using basic operating system commands.

If you need further assistance with transferring files, please refer to your operating system's instruction manual or on-screen help. If you are using media management software such as iTunes, Winamp, or Windows Media Player, please refer to their documentation for support.



Do not disconnect or otherwise interrupt the player during transmission—this could damage or corrupt the player's firmware or your files. If the player is accidentally disconnected and is not working properly, reset your player (see the Getting Started section for details).



Content owners use Windows Media digital rights management technology (WMDRM) to protect their intellectual property, including copyrights. This device uses WMDRM software to access WMDRM-protected content. If the WMDRM software fails to protect the content, content owners may ask Microsoft to revoke the software's ability to use WMDRM to play or copy protected content. Revocation does not affect unprotected content. When you download licenses for protected content, you agree that Microsoft may include a revocation list with the licenses. Content owners may require you to upgrade WMDRM to access their content. If you decline an upgrade, you will not be able to access content that requires the upgrade.

USB CONNECTIONS

Microsoft Windows

1. Double-click the “My Computer” icon on your desktop and then double-click the MP-C7057 icon (MTP Multimedia Player).
2. Your player contains two folders: Data and Media.
 - ✧ Drag your media files to the Media folder (e.g., MP3, WAV, WMA files).
 - ✧ Drag all other types of files to the Data folder for storage (e.g., TXT, DOC, XLS, etc). Data files are only visible from a computer; these files will not be available from within the player itself.

Macintosh OS X

1. Open a finder window. Located the files you would like to transfer from your computer. Select the files/folders with the mouse and press APPLE-C (copy) on the keyboard.
2. Click on the Removable Disk icon located on the left side of the finder window. The computer will display all files and folders currently stored in the player.
3. Press APPLE-V (paste) on the keyboard to transfer the files you selected in Step 1 to the player.

USB CONNECTIONS

Disconnecting from a Computer

Disconnect your player as instructed below to prevent data loss or file/firmware corruption.

Microsoft Windows

1. Double-click the green arrow in the taskbar located on the lower-right side of the computer screen (Safely Remove Hardware).



2. **Safely Remove Hardware:** Select “USB Mass Storage Device” from the list that appears and then click on “Stop”.
Stop a Hardware Device: Select “USB Mass Storage Device” from the list that appears and then click on “OK”.



Select “USB Mass Storage Device” from the list that appears and then click on “OK”.

3. When the “Safe to Remove Hardware” window appears, click the OK button and disconnect the USB cable from the player and your computer.

Macintosh OS X

1. On the left side of the Finder Window, identify the appropriate Removable Disk icon.

USB CONNECTIONS

2. Click on the “Eject” arrow on the right of the Removable Disk icon.
3. Disconnect the USB cable from the player and your computer.



VIDEO CONVERSION

Use the video conversion software utility included on the Installation CD to create video files that are suitable for playback on the MP-C7057.

Your player supports SMV files with the following specifications:

- ✦ 128 x 128 resolution at 15 frames per second (fps)



The video conversion software is included for your convenience and is compatible with Microsoft Windows operating systems only. There are many other video conversion utilities available for download or purchase on the internet.

Because the program is licensed free of charge, there is no warranty for the program, to the extent permitted by applicable law. Except when otherwise stated in writing the copyright holders and/or other parties provide the program "as is" without warranty of any kind, either expressed or implied, including, but not limited to, the implied warranties of merchantability and fitness for a particular purpose. The entire risk as to the quality and performance of the program is with you. Should the program prove defective, you assume the cost of all necessary servicing, repair or correction.

In no event unless required by applicable law or agreed to in writing will any copyright holder, or any other party who may modify and/or redistribute the program as permitted above, be liable to you for damages, including any general, special, incidental or consequential damages arising out of the use or inability to use the program (including but not limited to loss of data or data being rendered inaccurate or losses sustained by you or third parties or a failure of the program to operate with any other programs), even if such holder or other party has been advised of the possibility of such damages.

VIDEO CONVERSION

Installation

Please refer to the Installation CD for software installation procedures.

Converting Video

1. Select the Input Video file to convert. The source file must be one of the following video types: RAW, AVI, DivX, Microsoft WMV, Intel Indeo, or MPG.
 - ✧ DirectX 9.0, Media Player 9.0, and other codecs must be installed to support all media types.
2. Select the destination folder that the converted file will be saved to.
3. Click “CONVERT” to start the conversion process.
4. When the conversion is complete, copy the converted files to your player for playback.

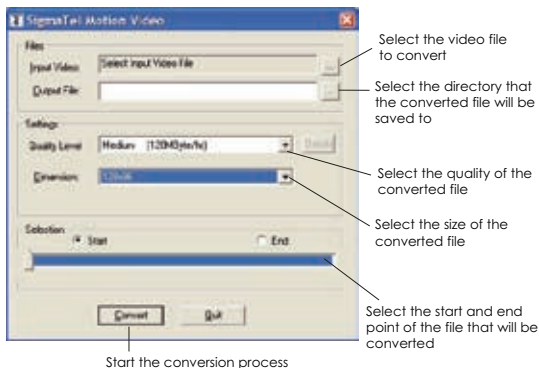

WINDOWS MEDIA PLAYER

You can use Windows Media Player and a USB-MTP connection to manage your music media library with Microsoft Windows XP or newer.

Please refer to the Quick Start Guide included with your player for more information.



For more information and support regarding music transfer and synchronization with Windows Media Player (WMP), please see the help section included with WMP (click Help > Synchronizing Content to Devices).

FIRMWARE UPGRADES

From time to time, COBY may release firmware upgrades to improve the performance of the MP-C7057 or to add additional features. Please check the COBY website periodically at www.cobyusa.com to see if new firmware has been released for your player. If you are experiencing abnormal behavior with your player, you may choose to restore (format) your player before updating its firmware.



Do not interrupt the firmware upgrade process—doing so could damage your player and render it inoperable.

See the documentation that is included with the firmware upgrade file for detailed instructions.

1. Connect your player to the computer.
2. Download the latest firmware for your player from www.cobyusa.com. Save this file to the computer.
3. Double-click the downloaded file (you may need a file compression utility installed on your computer). In the window that appears, double-click the file “stupdaterapp.exe” to start the upgrade utility.
4. A dialog box will appear. Click “OK”.
5. The updater will commence searching for your connected player. When it has detected your player, the firmware update screen will appear .
6. Click “Start” to begin the firmware update. Do NOT disconnect your player while it is updating.
7. The Update is complete when the green status bar has been filled. Click “Close”.
8. Disconnect your player from the computer.

FIRMWARE UPGRADES

Your player will turn on automatically and update its firmware.

**** You must have a file compression utility installed on your computer.***

ABOUT MP3/WMA MUSIC FILES

For more information about digital MP3 and WMA files, please visit our website at www.cobyusa.com.

TROUBLESHOOTING

If you have a problem with this device, please read the troubleshooting guide below and check our website at www.cobyusa.com for Frequently Asked Questions (FAQs) and firmware updates. If these resources do not resolve the problem, please contact Technical Support.

COBY Electronics Technical Support

Address: 56-65 Rust St.
Maspeth, NY 11378

Hours: 8:00 AM–11:00 PM EST, seven days a week

Phone: 718-416-3197 or 800-681-2629

Email: techsupport@cobyusa.com

Web: www.cobyusa.com

The player does not turn on.

- ✦ Ensure that the battery retains a charge. Try replacing the battery with a new one.
- ✦ Try resetting your player (use a pin to press the Reset key on the rear of the player).
- ✦ Ensure that the Hold switch is disengaged.

The buttons do not work.

- ✦ Ensure that the Hold switch is disengaged.

I cannot transfer files to the player.

- ✦ Ensure that your computer is running a supported operating system.

TROUBLESHOOTING

- ✦ If you are running Microsoft Windows 98 SE, ensure that the USB driver has been properly installed.
- ✦ If using the supplied USB extension cable, ensure that it is securely attached to the player and the PC, or try using another USB cable.
- ✦ If you have connected the player through a USB hub, try connecting the player directly to your computer.
- ✦ Ensure that the player's memory capacity is not full.
- ✦ Ensure that the Hold switch is disengaged.

There is no sound during playback.

- ✦ Check the volume level.
- ✦ Ensure that the headphones are attached securely to the player.

The sound quality of the music is poor.

- ✦ Try playing the file on your computer. If the sound quality is still poor, try downloading the file again or re-encoding the file yourself.
- ✦ Ensure that the bit rate of the file is not too low. The higher the bit rate of the file, the better it will sound. The minimum recommended bitrate is 128kbps for MP3s and 96kbps for WMAs.
- ✦ Try lowering the volume of the player.
- ✦ Ensure that the headphones are attached securely to the player.

TROUBLESHOOTING

The player will not play my music file.

- ✦ Ensure that the file is in a compatible format.
- ✦ The file may be copy-protected and you no longer have authorization to play this file. If you feel this is in error, please contact the service from which you downloaded the file.

The LCD characters are corrupted or something is wrong with the display.

- ✦ Ensure that the correct menu language has been set.
- ✦ Try resetting your player (use a pin to press the Reset key on the rear of the player).

The player has malfunctioned.

- ✦ Try resetting your player (use a pin to press the Reset key on the rear of the player).
- ✦ Try updating the player's firmware. Please refer to the [Firmware Upgrades](#) section of this manual for detailed instructions.

SPECIFICATIONS

| | |
|--------------------------|---|
| Display Type | 1.5" Full-Color CSTN @ 128 x 128 |
| Memory | 512MB Integrated Flash Memory |
| Audio Format Support | MP3, WMA, WMA-DRM, WAV |
| Video Format Support | SMV: 128 x 128, 15fps |
| Photo Format Support | JPEG |
| DRM Support | WMDRM10* |
| Song Info Support | ID3, LRC |
| Recording Format | IMA-ADPCM Encoding |
| FM Frequency Range | 87.5 - 108.0MHz |
| PC Interface | USB 2.0 Hi-Speed (MSC or MTP) |
| Plug and Play Support | Windows 98SE/2000/ME/XP or newer Mac OS X |
| Audio Output | 3.5mm Stereo (Headphone), Integrated Microphone |
| Audio Input | 3.5mm Stereo, Integrated Microphone |
| Menu Language Support | English, Dutch, French, German, Span- ish, or Portuguese |
| Power Supply | Rechargeable Lithium-ion Battery USB Charge |
| Unit Dimensions | 1.61" x 3.1" x 0.67" (WHD) |

* Music Service must support Windows Media DRM (WMDRM). WMDRM10 requires Windows XP and Windows Media Player 10 or newer.

Specifications and manual are subject to change without prior notice.

7057STD10

NOTES

COBY Electronics Corp.

56-65 Rust Street
Maspeth, NY 11378

www.cobyusa.com
www.ecoby.com