

# Aprilaire®

## ELECTRONIC THERMOSTATS



### MODEL 8353

5-2 Day Programmable  
1 Heat / 1 Cool  
Electric / Gas

**User's Manual**  
Installation and  
Programming



## Installation Guide

### IMPORTANT SAFETY INFORMATION WARNING:

- Always turn off power at the main power source by unscrewing fuse or switching circuit breaker to the off position before installing, removing, cleaning, or servicing thermostat.
- Read all of the information in this manual before installing or programming this thermostat.
- This is a 24V AC low-voltage thermostat. Do not install on voltages higher than 30V AC.
- All wiring must conform to local and national building and electrical codes and ordinances.
- Do not short (jumper) across terminals on the gas valve or at the system control to test installation. This will damage the thermostat and void the warranty.

## Features

- Four setpoints for weekday programming—two setpoints for weekend comfort.
- Two “AA” ENERGIZER brand batteries retain program memory, even during power outages.
- Low battery indicator.
- Fahrenheit/Celsius display option.
- Programmable from 45°F (4°C) to 90°F (32°C).
- Accuracy within ± 1 degree.
- Adjustable temperature differential: 1-3 degrees.
- Maintains summer and winter programming.
- Low temperature freeze protection. While in heat mode, thermostat will mechanically turn on heat if temperature drops to 40°F (4°C) – even if batteries are missing or drained.
- Automatic heating shutdown if temperature exceeds 90°F (32°C).

## Replacing Existing Thermostat

1. Turn off power to heating and cooling system.
2. Remove cover of old thermostat to expose wires. Do not disconnect wires. (Fig. 1)
3. Label wires per Table 1.

**Table 1**

Old Label	New Label	Description
M, 4, RH, R5 or R	RH	Heat Transformer, hot side
V or RC	RC	Cooling Transformer, hot side
Y or Y6	Y	Cooling control
H, W or 4	W	Heating control
F or G	G	Fan control relay
C*	Y or None	Either cooling control or common side of transformer

**\*NOTE:** On some older models, the C terminal can be either the cooling-control or the common side of the transformer. Check furnace wiring diagram to verify C terminal. If it is the common side of the transformer, cap the wire and tuck into the wall. If it is the cooling control, connect to the Y terminal.

4. After labeling wires, remove wires from terminals.
5. Remove existing thermostat base from wall.
6. Refer to the following section for instructions on how to install thermostat.

Figure 1

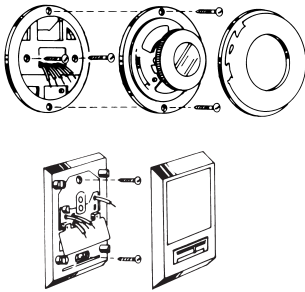

## Installing the Model 8353 Thermostat

**NOTE:** For new installations, mount thermostat on inside wall, 4-5 feet above the floor. Do not install behind a door, in a corner, near air vents, in direct sunlight, or near any heat or steam generating fixtures. Installation at these places will affect thermostat operation.

1. Turn power off to the heating and cooling systems.
2. Place COOL-OFF-HEAT In OFF position.

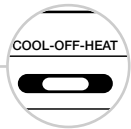
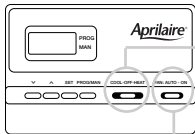

3. Place FAN: AUTO-ON switch Into AUTO position.



4. Remove the cover using a coin or screwdriver.

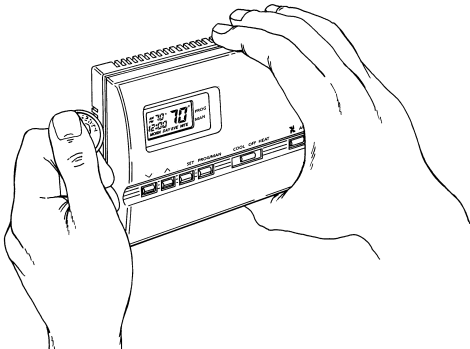
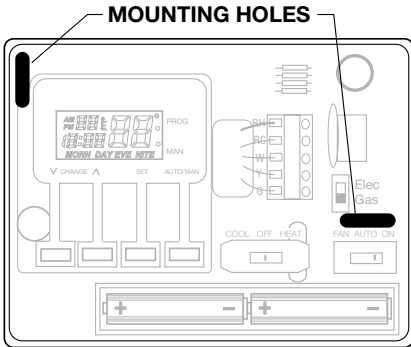

Figure 2

5. Place thermostat against the wall at desired location. Make sure wires will feed through opening on base of thermostat.
6. Mark placement of mounting holes. See Fig. 3. Set base aside.

Figure 3



7. Drill the marked holes using a 3/16" drill bit. Note: Enclosed plastic anchors do not require a drilled hole for drywall.
8. Tap plastic anchors into the wall.
9. Align base with plastic anchors and feed wires through opening. See Fig 4.

Figure 4

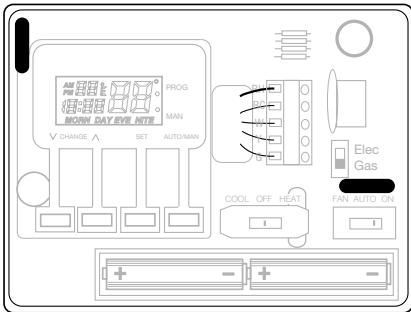

10. Secure base to wall with supplied screws.
11. Connect wires to terminal strip. Refer to wiring diagrams on other side of this sheet. Make sure wire connections are secure.
12. Place fan option switch into either the "ELEC" or "GAS" position depending upon the type of furnace. Refer to Figure 5.

Figure 5

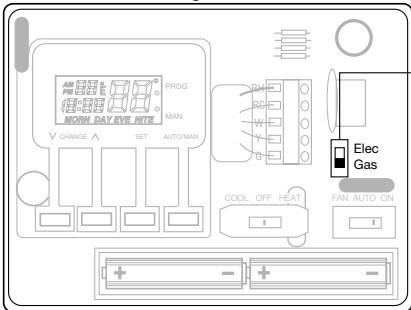

13. Install two "AA" ENERGIZER brand batteries or equivalent into battery compartment. Be sure to match positive (+) ends of batteries with positive (+) battery terminals in the battery compartment. The display will show as follows:

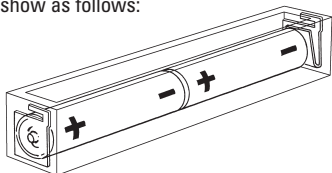

14. Replace cover onto thermostat by snapping into place.  
 15. Turn on power to system . Test thermostat as described in the following section.

## Programming Guide

### Set Time of Day, Day of Week, Temperature Differential

1. Press & Hold SET. Press PROG/MAN Release simultaneously.

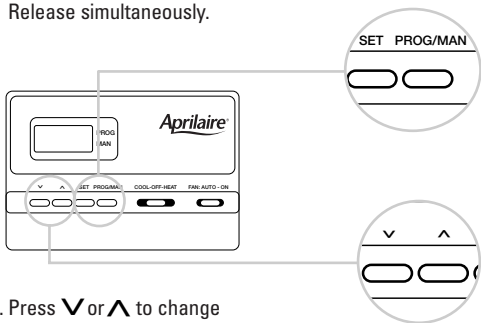

2. Press **v** or **^** to change Time of Day.

3. Press
- SET
- 

4. Press
- 

To Change Day of Week

<b>1=MO</b>
<b>2=TU</b>
<b>3=WE</b>
<b>4=TH</b>
<b>5=FR</b>
<b>6=SA</b>
<b>7=SU</b>

5. Press



6. Press



To change Temperature Differential\*

\*The Temperature Differential is Factory preset at 1°. This means that whenever the room temperature changes by one full degree from the temperature setting, the system will turn on. If the system turns on too often, increase the temperature differential.

7. Press SET to finish.

## Changing Fahrenheit (F) to Celsius (C)

Press and Hold SET



Press



Release both simultaneously.

## Setting Daily Programming

1. Place COOL-OFF-HEAT switch in COOL position.

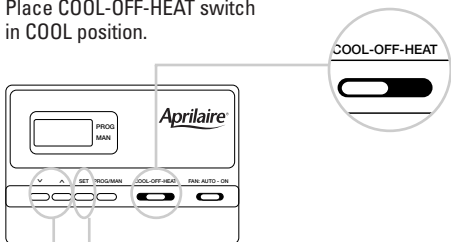

2. Press SET.



3. Press v or ^ to change MORN time in 30-minute intervals.



4. Press SET.

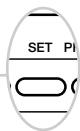
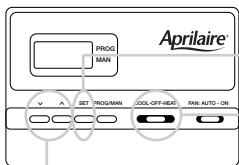

5. Press **V** or **^** to change MORN temperature.



6. Repeat Steps 2-5 for DAY, EVE, and NITE.

7. Press SET to finish.

8. Shift COOL-OFF-HEAT switch to HEAT position.

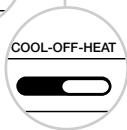

9. Repeat steps 2-7 to program HEAT (winter) settings.

**NOTE:** Both summer and winter programs use the same time settings.

Your thermostat is now programmed for summer and winter operation. It will follow the four settings (MORN, DAY, EVE, NITE) for weekday operation and two settings (MORN and NITE) for weekend operation. Adjust the program at any time by following the steps as outlined above.

## Begin Programmed Operation

1. Place FAN: AUTO-ON switch Into AUTO.

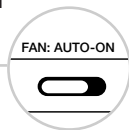
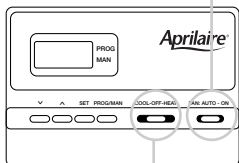

2. Place COOL-OFF-HEAT switch Into COOL or HEAT Depending upon the season.

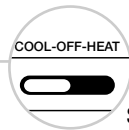

SUMMER

3. Press PROG/MAN button until indicator is in PROG position.

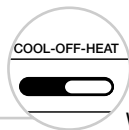

WINTER

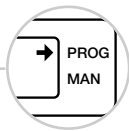
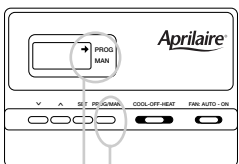

# Temporary Program Override

To temporarily increase or decrease temperature

Press **∇** or **▲**

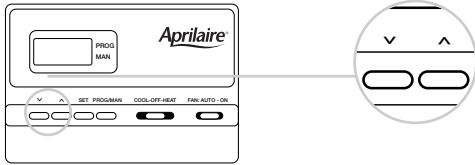

The thermostat will automatically return to the program at the next scheduled setting change or after four hours.

# Manual Operation

Manual operation allows continuous override of the program settings.

1. Press PROG/MAN until indicator is in MAN position.

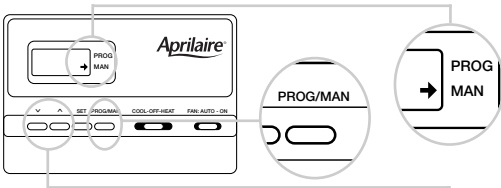

2. Press **∇** or **▲** to adjust temperature settings.



# Reset

To reset the thermostat to factory pre-programmed conditions, press the reset button located directly to the right of the display.

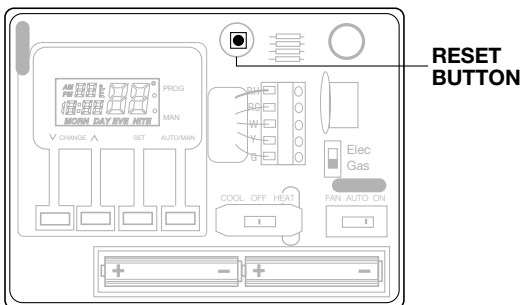



## To Test Thermostat

**WARNING:** DO NOT SHORT (JUMPER) ACROSS TERMINALS OF GAS VALVE OR SYSTEM CONTROL TO TEST OPERATION. THIS WILL DAMAGE THE THERMOSTAT AND VOID YOUR WARRANTY.

**CAUTION:** Do not switch system to cool if the temperature is below 50°F (10°C). This can damage the air conditioning system and cause personal injury.

1. Place the COOL-OFF-HEAT switch into the COOL position

COOL-OFF-HEAT



2. Press the **▼** button until the temperature setting is at least 3 degrees below the room temperature. The air conditioning system should turn on within a few seconds.

**NOTE:** There is a built in 5-minute delay on break for compressor protection. A second attempt to turn on the air conditioning will result in a 5-minute delay in compressor activation.

3. Put the COOL-OFF-HEAT switch into the OFF position. The air conditioning system should turn off. The fan may continue to run for a short period of time.

COOL-OFF-HEAT

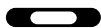

4. Put the COOL-OFF-HEAT switch into the HEAT position.

COOL-OFF-HEAT



5. Press the **▲** button until the temperature setting is at least 3 degrees above room temperature. The heating system should turn on. The fan may not turn on immediately, depending upon the fan delay built into the furnace.

6. Put the COOL-OFF-HEAT switch into the OFF position. The heating system should turn off. Once again, the fan may have a delay.

COOL-OFF-HEAT

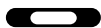

7. Put the FAN: AUTO-ON switch to the ON position. The blower fan should turn on.

FAN: AUTO - ON



8. Put the FAN: AUTO-ON switch to the AUTO position. The blower fan should turn off.

FAN: AUTO-ON



# Troubleshooting

Symptom	Remedy
Thermostat does not turn on system	Check Wiring (see INSTALLATION). Check fuse. Replace with 2 amp Slo-Blo fuse if fuse has opened.
Thermostat turns on and off too frequently.	Increase Temperature Differential (see PROGRAMMING).
Display is blank, flashing or constant "LO BAT."	Replace batteries.
Weekend Program follows four adjustment settings.	Verify that day of week is set correctly (see PROGRAMMING).
System fan does not operate properly.	Move fan option switch to either gas or electric, to match system (see INSTALLATION).
Time shown on display is not the current time of day.	Change time of day setting (see PROGRAMMING).
Thermostat does not follow program.	Thermostat in MANUAL mode (see PROGRAMMING). Thermostat may not have been programmed in HEAT or COOL position. Verify program. Check AM/PM indicators at time of day and programmed time changes (see PROGRAMMING). Verify program and day of week is correct (see PROGRAMMING).

**If problems with thermostat cannot be solved, call:**

Technical Support: 608-257-8801

Monday-Friday 7:45 am - 5:00 pm CST

# Wiring Diagrams

The following is just a sample of the most common types of HVAC systems. Refer to your systems installation manual for wiring information.

**HEAT/COOL  
4-WIRE  
SINGLE TRANSFORMER**

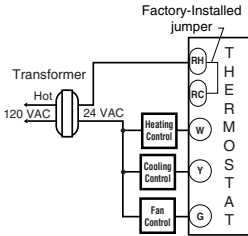

**HEAT ONLY  
3-WIRE  
SINGLE TRANSFORMER**

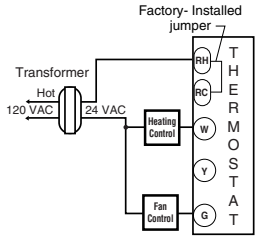

**HEAT ONLY  
2-WIRE  
SINGLE TRANSFORMER**

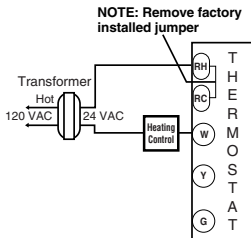

**COOL ONLY  
3-WIRE  
SINGLE TRANSFORMER**

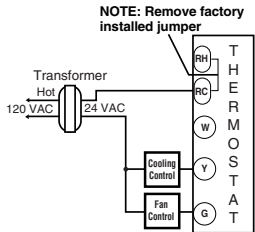

**HEAT/COOL  
5-WIRE  
TWO TRANSFORMER**

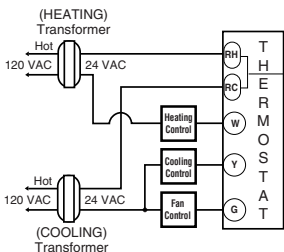

**NOTE: Cut center of factory installed jumper and bend back**

**NOTE: Both transformers must be in phase.**

# Limited Warranty

Your Research Products Corporation Aprilaire® Thermostat unit is expressly warranted for two (2) years from date of installation to be free from defects in materials and workmanship.

Research Products Corporation's exclusive obligation under this warranty shall be to supply, without charge, a replacement for any thermostat which is found to be defective within a two (2) year period and which is returned, together with the date of installation, no later than thirty (30) days after said two (2) year period by you to either your original supplier or to Research Products Corporation, Madison, Wisconsin 53701.

THIS WARRANTY SHALL NOT OBLIGATE RESEARCH PRODUCTS CORPORATION FOR ANY LABOR COSTS AND SHALL NOT APPLY TO DEFECTS IN WORKMANSHIP OR MATERIALS FURNISHED BY YOUR INSTALLER AS CONTRASTED TO DEFECTS IN THE THERMOSTAT ITSELF.

IMPLIED WARRANTIES OF MERCHANTABILITY OR FITNESS FOR A PARTICULAR PURPOSE SHALL BE LIMITED IN DURATION TO THE AFORESAID TWO YEAR PERIOD. RESEARCH PRODUCTS CORPORATION'S LIABILITY FOR INCIDENTAL OR CONSEQUENTIAL DAMAGES, OTHER THAN DAMAGES FOR PERSONAL INJURIES, RESULTING FROM ANY BREACH OF THE AFORESAID IMPLIED WARRANTIES OR THE ABOVE LIMITED WARRANTY IS EXPRESSLY EXCLUDED. THIS LIMITED WARRANTY IS VOID IF DEFECT(S) RESULT FROM FAILURE TO HAVE THIS THERMOSTAT INSTALLED BY A QUALIFIED HEATING AND AIR CONDITIONING CONTRACTOR. IF THE LIMITED WARRANTY IS VOID DUE TO FAILURE TO USE A QUALIFIED CONTRACTOR, ALL DISCLAIMERS OF IMPLIED WARRANTIES SHALL BE EFFECTIVE UPON INSTALLATION.

Some states do not allow limitations on how long an implied warranty lasts or the exclusion or limitation of incidental or consequential damages, so the above exclusion or limitations may not apply to you.

This warranty gives you specific legal rights and you may also have other rights which vary from state to state.

