

**Creda**

Tumble Dryer  
Instruction Book

TCS3

You must read these instructions prior to using the appliance and  
retain them for future reference



### Contents

#### Installation, 2

- Door reversal instructions
- Where to put your dryer
- Ventilation
- Water drain
- Electrical connection
- Before you start using your dryer

#### Dryer description, 3

- The front
- The back
- Control panel

#### Start and programmes, 4

- Choosing a programme

#### Laundry, 5-6

- Sorting your laundry
- Wash care labels
- Special clothing items
- Drying times

#### Warnings and Suggestions, 7

- General safety
- Disposal
- Saving energy and respecting the environment

#### Maintenance and Care, 8

- Switching off the electricity
- Cleaning the filter after each cycle
- Empty the water container after each cycle
- Check the drum after each cycle
- Cleaning the condenser unit
- Cleaning the dryer

#### Troubleshooting, 9

#### Service, 10

- Spare parts

# Installation

GB

! Keep this instruction booklet on hand in order to refer to it when necessary. Take it with you when you move, and should you sell this appliance or pass it on to another party, make sure that this booklet is supplied along with the dryer so that the new owner may be informed about warnings and suggestions on how the dryer works.  
! Read these instructions carefully; the following pages contain important information on installation and suggestions on how the appliance works.

## Door Reversal Instructions

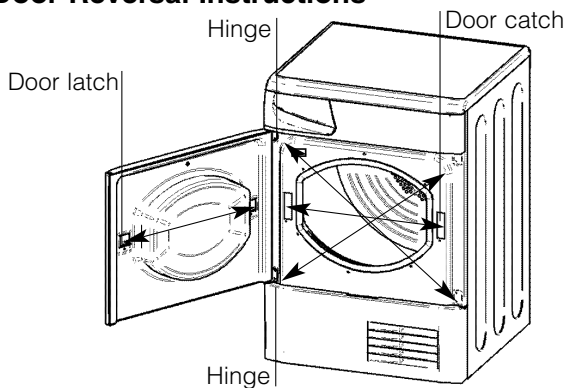

The door of your dryer is reversible and can easily be changed. Exchange diagonally hinge brackets and blanking screws. Exchange door latch and catch with their opposite blanking plates (*see diagram above*).

## Where to put your dryer

- Place your dryer at a distance from gas ranges, stoves, heaters, or cook tops because flames can damage the appliance.
- If you are going to install the appliance under a work counter, be sure to leave a 10mm space between the top and any other objects on or above the machine and a 15mm space between the sides and lateral furnishings or walls. This is to ensure proper air circulation. Make sure that the back vents are not obstructed.

## Ventilation

When the dryer is in use, there has to be adequate ventilation. Make sure you put your dryer in an environment that is not damp and has proper air circulation throughout. Airflow around the dryer is essential to condense the water produced during the washing, the dryer will not operate efficiently in an enclosed space or cupboard.  
! If using the dryer in a small or cold room some condensation could be experienced.

## Water drain

If your dryer is installed next to a drain the water can be plumbed into this drain. This does away with the need to empty the water container. Simply remove the top hose from its top fitting at the rear of the dryer and plumb the hose provided to the drain.

## Electrical connections

Make sure of the following before you insert the plug into the the electrical socket:

- The socket must be grounded.
  - The socket must be able to sustain the machines maximum power, which is indicated on the rating label (*see Dryer Description*).
  - Power voltage must be within the values indicated on the rating label (*see Dryer Description*).
  - The socket must be compatible with the dryers plug.  
Should this not be the case, replace the plug or the socket.
- ! The dryer must not be installed outdoors, even if the space is sheltered. It can be very dangerous if it is exposed to rain or storms.  
! Once installed, the dryers electrical wire and plug must be within easy reach.  
! Do not use extension cords.  
! The power cord must not be bent or squashed.  
! The power cord supplied is fitted with a BS1363 plug and a 13 amp BS1362 fuse. If you need to replace the fuse, use only those rated at 13 amp (13A) and ASTA approved to BS1362.

## Moulded plug

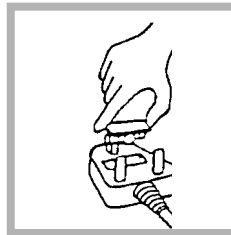

! The plug must not be used without the fuse cover in place.  
If a replacement fuse holder/cover is required, it must be of the same colour coding or wording as shown on the base of the plug.  
Replacements are available from authorised dealers.

## Changing the plug

The wires in the power cord are coloured in accordance with the following:

Green and Yellow (Earth) wire to terminal marked 'E', symbol  $\perp$ , or coloured green and yellow.

Blue (Neutral) wire to terminal marked 'N' or coloured black.

Cord clamp

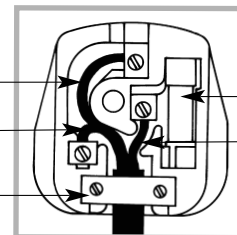

13A ASTA approved fuse to BS1362.

Brown (Live) wire to terminal marked 'L' or coloured red.

! If the plug being replaced is a non-rewirable type, then the cut-off plug must be disposed of safely. DO NOT leave it where it can be inserted into a socket and create a shock hazard.

! The power supply cord should be checked periodically and replaced by a cord specially prepared for this dryer and fitted only by authorised technicians (*see Service*). New or longer power cords are supplied at an extra charge by authorised dealers.

! The manufacturer denies any responsibility should any of these rules not be followed.

! If in doubt about any of the above consult a qualified electrician.

## Before you start using your dryer

Once you have installed your dryer and before you use it, clean the inside of the drum to remove any dust that could have accumulated during transport.

# Dryer Description



## To open the door

Press and release the front panel in position shown

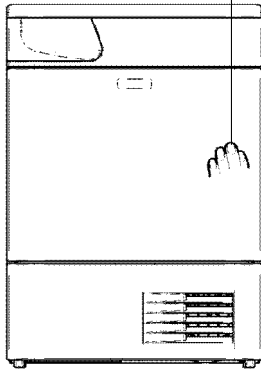

## The features

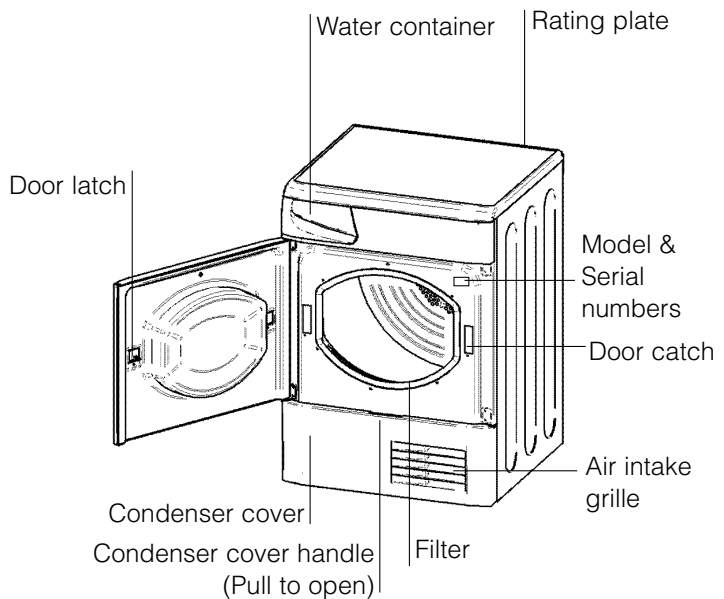

## Control panel

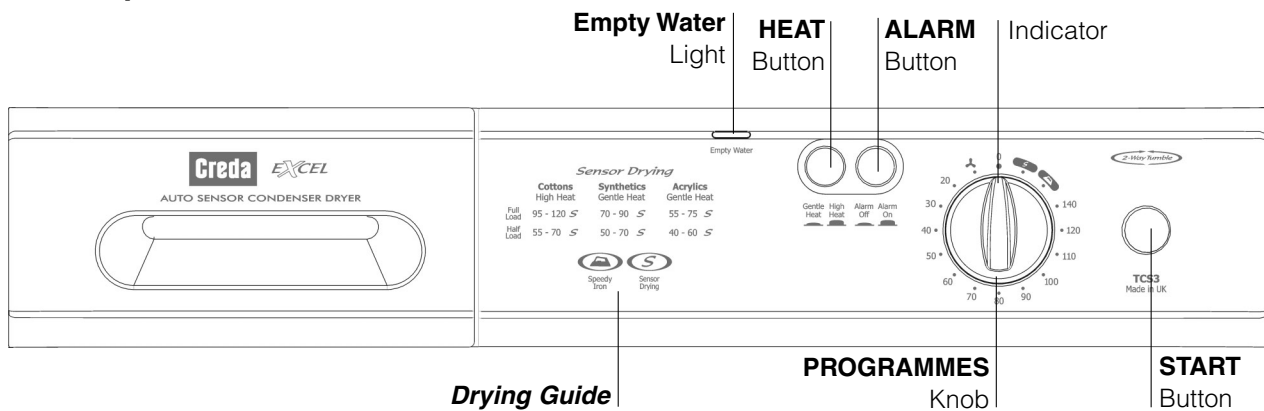

The **START** button begins drying a selected programme (see *Start and Programmes*).

The **HEAT** button selects drying temperature (see *Start and Programmes*).

Out: HIGH Heat  
In: GENTLE (LOW) Heat

The **ALARM** buzzer signals the end of a drying cycle.

Out: buzzer ON  
In: buzzer OFF

The **Drying Guide** allows you to consult a user friendly table of fabric types and load capacities.

The **Empty Water** light signals that the water container is full and must be emptied. The light will take a few seconds to go out after replacing the empty water container, the dryer must be running for this to happen.

The **PROGRAMMES** knob sets the programme: rotate until the indicator is pointing to the programme you want to select (see *Start and Programmes*).

GB

Installation

Description

Start and Programmes

Laundry

Warnings and Suggestions

Maintenance and Care

Troubleshooting

Service

# Start and Programmes

GB

## Choosing a programme

1. Plug the dryer into the electrical socket.
2. Sort your laundry according to fabric type (*see Laundry*).
3. Open the door and make sure the filter is clean and in place and the water container is empty and in place (*see Maintenance*).
4. Load the machine and make sure items are not in the way of the door seal. Close the door.
5. Choose a drying programme by checking the Programmes table (*see Programmes*) as well as the indications for the type of fabric (*see Laundry*).
  - Set the temperature with the HEAT button.
  - Select a programme or drying time by rotating the PROGRAMME knob.
6. If you wish the buzzer to sound at the end of the programme, press the ALARM button.
7. Press the START button to begin. During the drying programme, you can check on your laundry and take out items that are dry while others continue drying. When you close the door again, press the START button in order to resume drying.
8. About 10 minutes before the programme is completed, it enters the final COOL TUMBLE phase (fabrics are cooled), which should always be allowed to complete.
9. Open the door, take the laundry out, clean the filter and replace it. Empty the water container and replace it (*see Maintenance*).
10. Unplug the dryer.

---

## Water container and empty water light

If you have plumbed your dryer to a drain this light can be ignored, as there is no need to empty the water container.







When this light is on (not flashing) it reminds you to empty the water container.

If the water container fills during a programme, the light flashes and the dryer does the Cool Tumble phase (*see Programmes*). You must empty the water container and restart the dryer or the clothes will not dry. After re-starting the dryer the light will take a few seconds to go out.

To avoid this always empty the water container each time you use the dryer (*see Maintenance*).

# Start and Programmes

## Programmes

Programme	What it does...	How to set it...	Note:
 <b>Cupboard dry</b>	Dries your clothes, ready for putting away.	<ol style="list-style-type: none"> <li>1. Position the PROGRAMMES knob on .</li> <li>2. Select High or Gentle Heat.</li> <li>3. Select Alarm option, if required.</li> <li>4. Press the START button.</li> </ol>	<p><b>Options available:</b> Alarm, High or Low Heat</p> <p>! Do not dry Synthetics or Acrylics on High Heat (<i>see Laundry</i>).</p>
 <b>Speedy Iron</b>	Brief programme (approximately 10 minutes) that softens fibres of clothing that is ready for ironing.	<ol style="list-style-type: none"> <li>1. Position the PROGRAMMES knob on .</li> <li>2. Select High Heat.</li> <li>3. Select Alarm option, if required.</li> <li>4. Press the START button.</li> </ol>	<p><b>Options available:</b> Alarm</p> <p>! This is not a drying programme (<i>see below</i>).</p>
<b>Timed Drying</b> (140, 120, 110, 100, 90, 80, 70, 60, 50, 40, 30 or 20 minutes)	For drying small loads (less than 1kg) or if you prefer to use a timed programme.  Should be used if you prefer a damper result than Cupboard dry. eg. a damper result suitable for ironing.	<ol style="list-style-type: none"> <li>1. Position the PROGRAMME knob on the desired time: 140, 120, 110, 100, 90, 80, 70, 60, 50, 40, 30 or 20.</li> <li>2. Select High or Gentle Heat.</li> <li>3. Select Alarm option if required.</li> <li>4. Press the START button.</li> </ol>	<p><b>Options available:</b> Alarm, High or Low Heat</p> <p>! Do not dry Synthetics or Acrylics on High Heat (<i>see Laundry</i>).</p> <p>Consult suggested drying times (<i>see Laundry</i>).</p> <p>The last 10 minutes of these programmes is the Cool Tumble phase (<i>see below</i>).</p>
 <b>Cool Tumble</b>	Brief programme (approximately 10 minutes) that cools fibres of clothing.	<ol style="list-style-type: none"> <li>1. Position the PROGRAMME knob on .</li> <li>2. Select Alarm option, if required.</li> <li>3. Press the START button.</li> </ol>	<p><b>Options available:</b> Alarm</p>

### Speedy Iron

'Speedy Iron' is a short 10 minute programme (8 minutes of heat followed by a 2 minute cool tumble period) which fluffs the fibres of clothing that have been left in the same position/location for an extended period of time. The cycle relaxes the fibres and makes them easier to iron and fold.

! 'Speedy Iron' is **not a drying programme** and should not be used for wet articles of clothing.

For best results:

1. Do not load more than the maximum capacity.  
These numbers refer to the dry weight:

Fabric	Maximum load
Cotton and Cotton mixtures	2.5kg
Synthetics	2kg
Denim	2kg

2. Unload the dryer immediately after the end of the drying programme, hang, fold or iron the articles and put them away in the closet. Should this not be possible repeat the programme.

The 'Speedy Iron' effect varies from one fabric to the next. It works well on traditional fabrics like Cotton or Cotton mix, and less well on acrylic fibres and on materials such as Tencel®.

GB

Installation

Description

Start and Programmes

Laundry

Warnings and Suggestions

Maintenance and Care

Troubleshooting

Service

# Laundry

GB

## Sorting your laundry

- Check symbols on clothing labels to make sure that the articles can be tumble dried.
- Sort laundry by fabric type.
- Empty pockets and check buttons.
- Close zippers and hooks and tie loose belts and strings.
- Wring out each item in order to eliminate as much excess water as possible.

! Do not load dripping wet clothes into the dryer.

### Maximum load size

Do not load more than maximum capacity.

These numbers refer to dry weight:

Natural fibres: 6kg max (13lb)

Synthetic fibres: 3kg max (6.6lb)

! DO NOT overload the dryer as this could result in reduced drying performance.

### Typical load





Clothes			
Blouse	Cotton	150g	5oz
	Other	100g	3oz
Dress	Cotton	500g	1lb 2oz
	Other	350g	12oz
Jeans		700g	1lb 6oz
10 nappies		1000g	2lb 3oz
Shirt	Cotton	300g	10oz
	Other	200g	7oz
T-Shirt		125g	4oz

Household Items			
Duvet cover (Double)	Cotton	1500g	3lb 5oz
	Other	1000g	2lb3oz
Large Tablecloth		700g	1lb 6oz
Small Tablecloth		250g	9oz
Tea Towel		100g	3oz
Bath Towel		700g	1lb 6oz
Hand Towel		350g	12oz
Double Sheet		500g	1lb 2oz
Single Sheet		350g	12oz

At the end of a drying cycle, cottons could still be damp if you grouped cottons and synthetics together. If this happens simply give them an additional short period of drying.

## Wash Care Labels

Look at the labels on your garments, especially when tumble drying for the first time. The following symbols are the most common:

-  May be tumble dried
-  Do **not** tumble dry
-  Tumble dry at high heat setting
-  Tumble dry at low heat setting

### Items not suitable for tumble drying

- Articles that containing rubber or rubber-like materials or plastic film (pillows, cushions, or PVC rainwear), any other flammable articles or objects that contain flammable substances (towels soiled with hair spray).
- Glass fibres (certain types of draperies)
- Items which have been dry cleaned
- Items with the ITCL Code  (*see Special clothing items*). These can be cleaned with special at-home dry cleaning products. Follow instructions carefully.
- Large bulky items (quilts, sleeping bags, pillows, cushions, large bedspreads etc). These expand when drying and would prevent airflow through the dryer.



## Special clothing items









**Blankets and Bedspreads:** acrylic items (Acilan, Courtelle, Orion, Dralon) **must be dried** with special care on LOW heat setting. Avoid drying for a long period of time.

**Pleated or creased garments:** read the manufacturer's drying instructions on the garment.

**Starched articles:** do not dry these with non-starched items. Make sure that as much of the starch solution is removed from the load as possible before placing it in the dryer. Do not over-dry: the starch will become powdery and leave your clothing limp, which defeats the purpose of starch.

## Drying times

The table below presents APPROXIMATE drying times in minutes. Weights refer to dry garments:

Cottons  / 					
High (full) Heat 					
Drying times 800-1000rpm in washing machine					
		Half Load			Full Load
1kg	2kg	3kg	4kg	5kg	6kg
30-40	40-55	55-70	70-80	80-90	95-120
Synthetics 					
Low (gentle) Heat 					
Drying times on reduced spin in washing machine					
	Half Load		Full Load		
1kg	2kg		3kg		
40-50	50-70		70-90		
Acrylics  / 					
Low (gentle) Heat 					
Drying times on reduced spin in washing machine					
Half Load			Full Load		
1kg			2kg		
40-60			55-75		

Times are approximate and can vary depending upon:

- Amount of water retained in clothes after spin cycle: towels and delicates retain a lot of water.
- Fabrics: items that are the same type of fabric but different textures and thicknesses may not have the same drying time.
- Quantity of laundry: single items or small loads may take longer to dry.
- Dryness: If you are going to iron some of your clothes, they can be taken out while still a bit damp. Others can be left longer if you need them to be completely dry.
- Heat setting.
- Room temperature: if the room where the dryer is located is cold, it will take longer for the dryer to dry your clothes.
- Bulk: some bulky items can be tumble dried with care. We suggest that you remove these items several times, shake them out, and return them to the dryer until finished.

! Do not over-dry your clothes.

All fabrics contain a little natural moisture, which keeps them soft and fluffy.

GB

Installation

Description

Start and Programmes

Laundry

Warnings and Suggestions

Maintenance and Care

Troubleshooting

Service

# Warnings and Suggestions

GB

! The appliance has been designed and built according to international safety standards. These warnings are given for safety reasons and must be read carefully.



This appliance conforms to the following EEC Directives:

- 72/23/EEC and 93/68/EEC (Low Voltage Equipment)  
- 89/336/EEC, 92/31/EEC and 93/68/EEC (Electromagnetic Compatibility)

## General safety

- This tumble dryer has been designed for home, and not professional use.
- This dryer must be used by adults, and the instructions in this booklet should be followed carefully.
- Do not touch the appliance while barefoot or with wet hands or feet.
- Unplug the machine by pulling on the plug, not the cord.
- Children must not be in proximity of the dryer when in use. After using the dryer, turn it off and unplug it. Keep the door closed to make sure that children do not use it as a toy.
- The appliance must be installed correctly and have proper ventilation. The air intake at the front of the dryer and rear vent behind the dryer should never be obstructed (*see Installation*).
- Never use the dryer on carpeting where the pile height would prevent air from entering the dryer from the base.
- Check to see if the dryer is empty before loading it.
-  The back of the dryer could become very hot. Never touch it while in use.
- Do not use the dryer unless the filter, water container and condenser are securely in place (*see Maintenance*).
- Do not use liquid fabric softeners in the dryer, add it to the final rinse of your wash.
- Do not overload the dryer (*see Laundry* for maximum loads).
- Do not load items that are dripping wet.
- Tumble dry items only if they have been washed with detergent and water, rinsed and been through the spin cycle. It is a fire hazard to dry items that HAVE NOT been washed with water.
- Carefully check all instructions on clothing labels (*see Laundry*).
- Do not dry garments that have been treated with chemical products.

- Never dry articles that are contaminated with flammable substances (petrol, oil, paint, hair spray, creams, cooking fat or oils).
- Do not tumble dry rubber, foam rubber, plastic, plastic foam, nappy pants or liners, polythene or paper.
- Do not tumble dry large, very bulky items.
- Do not tumble dry acrylic fibres at high temperatures.
- Complete each programme with its Cool Tumble Phase.
- Do not turn off the dryer when there are still warm items inside.
- Clean the filter after each use (*see Maintenance*).
- Empty the water container after each use (*see Maintenance*).
- Clean the condenser unit after regular intervals (*see Maintenance*).
- Do not allow lint to collect around the dryer.
- Never climb on top of the dryer. It could result in damage.
- Always follow electrical standards and requirements (*see Installation*).
- Always buy original spare parts and accessories (*see Service*).

## Disposal

- Disposing of the packaging material: follow local regulations, so the packaging can be recycled.
- Disposal of your old dryer: cut the power cord and remove the door before disposing of an old dryer.

## Saving energy and respecting the environment

- Wring out items to eliminate excess water before tumble drying (if you use a washing machine first, select a high spin cycle). Doing this will save time and energy during drying.
- Always dry full loads - you save energy: single items or small loads take longer to dry.
- Clean the filter after each use to contain energy consumption costs (*see Maintenance*).

## Switching off the electricity

! Unplug your dryer when not using it, when cleaning it and during all maintenance operations.

## Clean the filter after each cycle

The filter is an important part of your dryer: it accumulates lint and fluff that is formed while drying. When finished drying, clean the filter by rinsing it under running water or with your vacuum cleaner. Should the filter become clogged up, the airflow inside the dryer will be seriously compromised: drying times lengthen and you will consume more energy. It may also damage your dryer.

The filter is found in front of the dryer trim (*see diagram*).

Removing the filter:

1. Pull the plastic grip of the filter upwards (*see diagram*).
2. Clean the filter and replace it correctly.  
Ensure the filter is fully located flush into the tumble dryer trim.

! Do not use the dryer without replacing the filter.

## Empty the water container after each cycle

Pull the container out of the dryer and empty it into a sink or other suitable drain. Replace the water container securely.

Always check and empty the container before you start a new drying programme.

## Check the drum after each cycle

Turn the drum manually in order to remove small items (handkerchiefs) that could have been left behind.

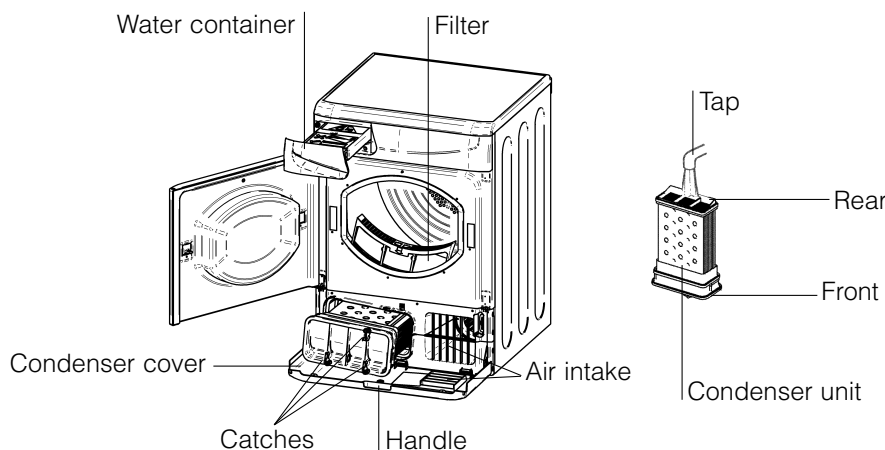

## Cleaning the condenser unit

Periodically (every month) remove the condenser unit and clean any build up of fluff from between the plates by rinsing it under the tap with cold water. This should be done with cold water from the rear of the condenser.

Removing the condenser:

1. Unplug the dryer and open the door.
2. Pull open the condenser cover (*see diagram*).  
Release the three catches by turning 90° counter-clockwise then pull on the grip and remove from the dryer.
3. Clean the surface of the seals and replace, making sure that the catches have been secured.

## Cleaning the dryer

- External parts in metal or plastic and rubber parts can be cleaned with a damp cloth.
- Periodically clean the surface of the stainless steel sensor inside the drum with vinegar to remove water contaminates. Apply carefully with a cloth, this will maintain the drying performance of the dryer. The sensor is located on the plastic vane inside the drum towards the front of the dryer. Rotate the drum if necessary to locate it.
- Periodically (every 6 months) vacuum the front air intake grille and vents at the rear of the dryer, to remove any build up of fluff, lint or dust. Also to remove accumulation of fluff from the front of the condenser and filter areas, clean occasionally with a vacuum cleaner.

! Do not use solvents or abrasives.

! Your dryer uses special bearing components which do not need lubrication.

! Have your dryer checked regularly by authorised technicians to ensure electrical and mechanical safety (*see Service*).

GB

Installation

Description

Start and Programmes

Laundry

Warnings and Suggestions

Maintenance and Care

Troubleshooting

Service

# Troubleshooting

GB

One day your dryer seems not to be working. Before you call your Service Centre (*see Service*), go through the following troubleshooting suggestions:

## Problem:

## Possible causes / Solution:

### The tumble dryer won't start.

- The plug is not plugged into the socket, or not making contact.
- There has been a power failure.
- The fuse has blown. Try to plug another appliance into the socket.
- You are using an extension cord? Try to plug the dryer's power cord directly into the socket.
- The door is not closed securely?
- The PROGRAMMES knob has not been set properly (*see Start and Programmes*).
- The START button has not been pressed (*see Start and Programmes*).

### It is taking a long time to dry.

- The filter has not been cleaned (*see Maintenance*).
- The temperature setting is not ideal for the type of fabric you are drying (*see Start and Programmes, and see Laundry*).
- The water container needs emptying? The empty water light is flashing? (*see Maintenance*).
- The condenser needs cleaning? (*see Maintenance*).
- The correct drying time has not been selected for the load (*see Laundry*).
- The air intake grille or rear vents are obstructed (*see Installation, and see Maintenance*).
- The items were too wet (*see Laundry*).
- The dryer was overloaded (*see Laundry*).

### Empty water light is on and the water container is not full.

- This is normal, the light flashes when the container is full. If the light is on but not flashing it is just a reminder to empty the container (*see Start and Programmes*).

### Programme finishes and clothes are damper than expected.

- ! For safety the dryer has a maximum programme time of 4 hours. If an automatic programme has not sensed the required final moisture in this time the dryer will complete the programme and stop. Check the above points and run the programme again, if the results are still damp, contact the Service Centre (*see Service*).

## Before calling the Service Centre:

- Use the troubleshooting guide to see if you can solve the problem yourself (*see Troubleshooting*).
- If not, turn off the dryer and call the Service Centre closest to you.

### What to tell the Service Centre:

- name, address and post code.
- telephone number.
- the type of problem.
- the date of purchase.
- the appliance model (Mod.).
- the serial number (S/N).

This information can be found on the data label inside the door of the machine.

## Spare Parts

This dryer is a complex machine. Repairing it yourself or having a non-authorized person try to repair it could cause harm to one or more persons, could damage the machine and could invalidate the spare parts warranty.

Call an authorised technician if you experience problems while using the machine.

The spare parts have been designed exclusively for this appliance and not for other uses.

GB

Installation

Description

Start and Programmes

Laundry

Warnings and Suggestions

Maintenance and Care

Troubleshooting

Service







## Key Contacts

### After Sales Service

Over 1100 trained specialists, directly employed by us, ensure that you can have complete confidence in both the appliances and services we offer.

### Repair Service and Information Help Desk

UK: 08709 066 066

Monday to Friday, 8am to 7.30pm

Saturday, 8.30am to 5.30pm

Sunday, 9.30am to 3.30pm

[www.credaservice.co.uk](http://www.credaservice.co.uk)

Republic of Ireland: 1850 302 200

Note: Our operators will require the following information:

Model number

Serial number

### Extended Warranties

UK: 08709 088 088

Monday to Sunday, 8am to 8pm

[www.credaservice.co.uk](http://www.credaservice.co.uk)

Republic of Ireland: 1850 502 200

### Genuine Parts and Accessories

UK: 08709 077 077

Monday to Friday, 8.30am to 5pm

Saturday, 8.30am to 12noon

[www.credaservice.co.uk](http://www.credaservice.co.uk)

Republic of Ireland: (01) 842 6836

[www.creda.co.uk](http://www.creda.co.uk)

**Indesit** Company UK Limited, Morley Way, Peterborough, PE2 9JB