



POD X3 Family

Pilot's Handbook

Manuel de pilotage

Pilotenhandbuch

Pilotenhandboek

Manual del Piloto

An in-depth exploration of the advanced technologies and pulsing tonal pleasures of POD X3, POD X3 Live & POD X3 Pro.

The serial number can be found on the bottom or back of your POD X3, POD X3 Live or POD X3 Pro. It's the number that begins with "(21)". Please note it here for future reference:

SERIAL NO: _____

WARNING: To reduce the risk of fire or electric shock, do not expose this appliance to rain or moisture.

CAUTION: To reduce the risk of fire or electric shock, do not remove screws. No user-serviceable parts inside. Refer servicing to qualified service personnel.

NOTICE: This equipment has been tested and found to comply with the limits for a Class B digital device pursuant to Part 15 of FCC Rules. Operation is subject to the following two conditions: (1) This device may not cause harmful interference, and (2) this device must accept any interference received, including interference that may cause undesired operation.



The lightning symbol within a triangle means "electrical caution!" It indicates the presence of information about operating voltage and potential risks of electrical shock.



The exclamation point within a triangle means "caution!" Please read the information next to all caution signs.

You should read these Important Safety Instructions Keep these instructions in a safe place

Before using your POD X3, POD X3 Live or POD X3 Pro, carefully read the applicable items of these operating instructions and safety suggestions.

1. Obey all warnings on the POD X3, POD X3 Live or POD X3 Pro, and in this Pilot's Handbook.
2. Do not place near heat sources, such as radiators, heat registers, or appliances which produce heat.
3. Guard against objects or liquids entering the enclosure.
4. Connect only to AC power outlets rated 100-120V or 230V 47-63Hz (depending on the voltage range of the included power supply).
5. Do not step on power cords. Do not place items on top of power cords so that they are pinched or leaned on. Pay particular attention to the cord at the plug end and the point where it connects to the POD X3, POD X3 Live or POD X3 Pro.
6. Unplug your POD X3, POD X3 Live or POD X3 Pro when not in use for extended periods of time.
7. Do not perform service operations beyond those described in this Pilot's Handbook. In the following circumstances, repairs should be performed only by qualified service personnel:
 - liquid is spilled into the unit
 - an object falls into the unit
 - the unit does not operate normally or changes in performance in a significant way
 - the unit is dropped or the enclosure is damaged
8. Prolonged listening at high volume levels may cause irreparable hearing loss and/or damage. Always be sure to practice "safe listening."

Please Note:

Line 6, POD, POD X3, POD X3 Live, POD X3 Pro, PODxt, Vetta, FBV, FBV Shortboard, FBV Express, and FBV4 are trademarks of Line 6, Inc. All other product names, trademarks, and artists' names are the property of their respective owners, which are in no way associated or affiliated with Line 6. Product names, images, and artists' names are used solely to identify the products whose tones and sounds were studied during Line 6's sound model development for this product. The use of these products, trademarks, images, and artists' names does not imply any cooperation or endorsement.

Table of Contents

Tutorial: POD X3 Live for Guitar	1•1
Tutorial: POD X3 & POD X3 Pro for Guitar	2•1
Controls & Connections	3•1
POD X3	3•1
POD X3 Live.....	3•8
POD X3 Pro	3•16
Getting Around, Tones & Tuner	4•1
Home Page	4•1
The Dual Tone Concept	4•3
Tone Volume Controls.....	4•5
Preset Folders	4•7
Recalling Presets	4•8
Recalling User Presets on POD X3 Live.....	4•9
Locking Tone 2	4•10
Saving Tones	4•11
Tuner	4•12
Reference: Tweaking Tones	5•1
Amp + Cab	5•1
Tone Controls	5•2
Stomp Boxes.....	5•4
Modulation Effects	5•7
Delay	5•9
Reverb	5•11
Gate.....	5•12
Compressor.....	5•13

EQ	5•14
Wah	5•15
Volume Pedal	5•16
Effects Loop (X3 Live & Pro)	5•17

Reference: Configuration & Setup 6•1

Inputs.....	6•1
Outputs.....	6•2
System	6•5
Commands	6•7

Example Setups 7•1

Mono or Stereo Recording or Direct to Mixer/PA.....	7•1
Recording Tone 1 & 2 to Separate Mono Tracks	7•2
Recording Tone 1 & 2 to Separate Stereo Tracks (X3 Live & Pro).....	7•2
Feed One Guitar Amp	7•3
Feed Two Guitar Amps, One for Tone 1 and One for Tone 2.....	7•3
Feed Two Guitar Amps, One “Wet” and One “Dry”	7•4
Feed a Guitar Amp & Send Separate XLR Direct Outs (X3 Live & Pro)....	7•5
Electric Guitar to On-Stage Amp and Direct Out + Vocals/Acoustic/etc. to Direct Out Only.....	7•6

USB & Computer Software..... 8•1

Updating POD X3, POD X3 Live or POD X3 Pro’s Firmware.....	8•1
Setting Up for USB Recording	8•2

Appendix A: Signal Flow A•1

POD X3.....	A•1
POD X3 Live.....	A•2
POD X3 Pro	A•3

TUTORIAL: POD X3 LIVE FOR GUITAR

1. Plug your guitar into Guitar In.

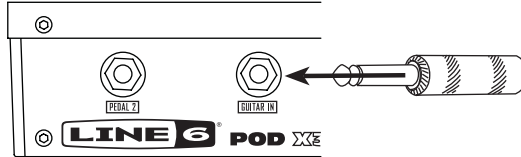

2. Turn on POD X3 Live.
3. Recall User Preset “32D: Tutorial1”.

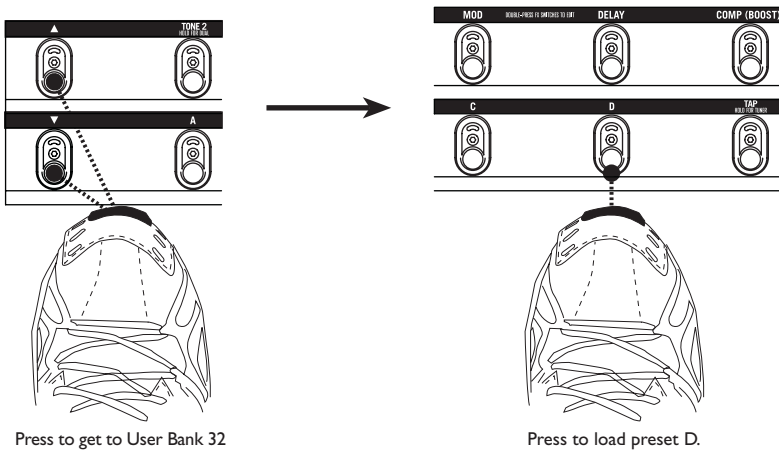

4. The Home Page shows with the Amp+Cab block selected.

The outlined block is the selected one.

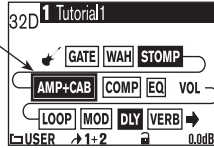

5. Pick an Amp Model.

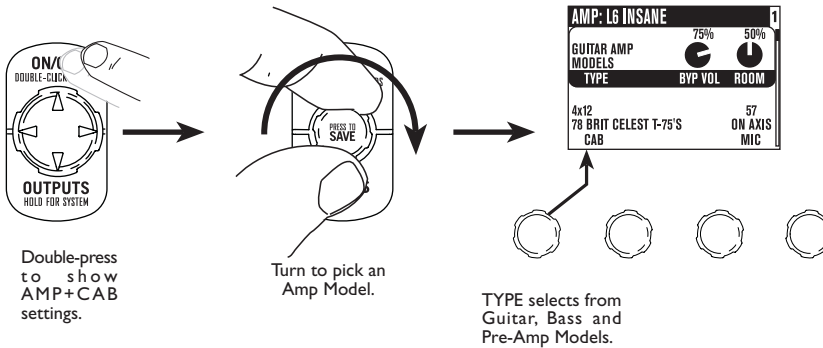

6. Tweak the Amp Tone Controls.

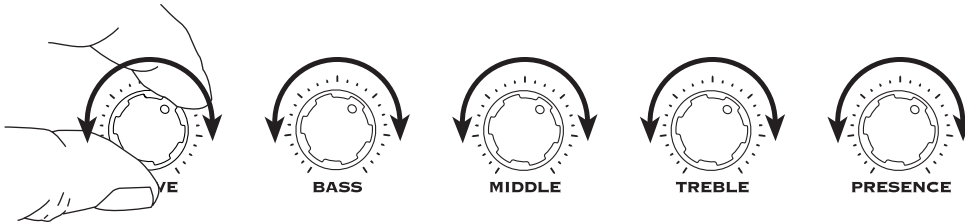

7. Pick a Stomp Model and tweak it.

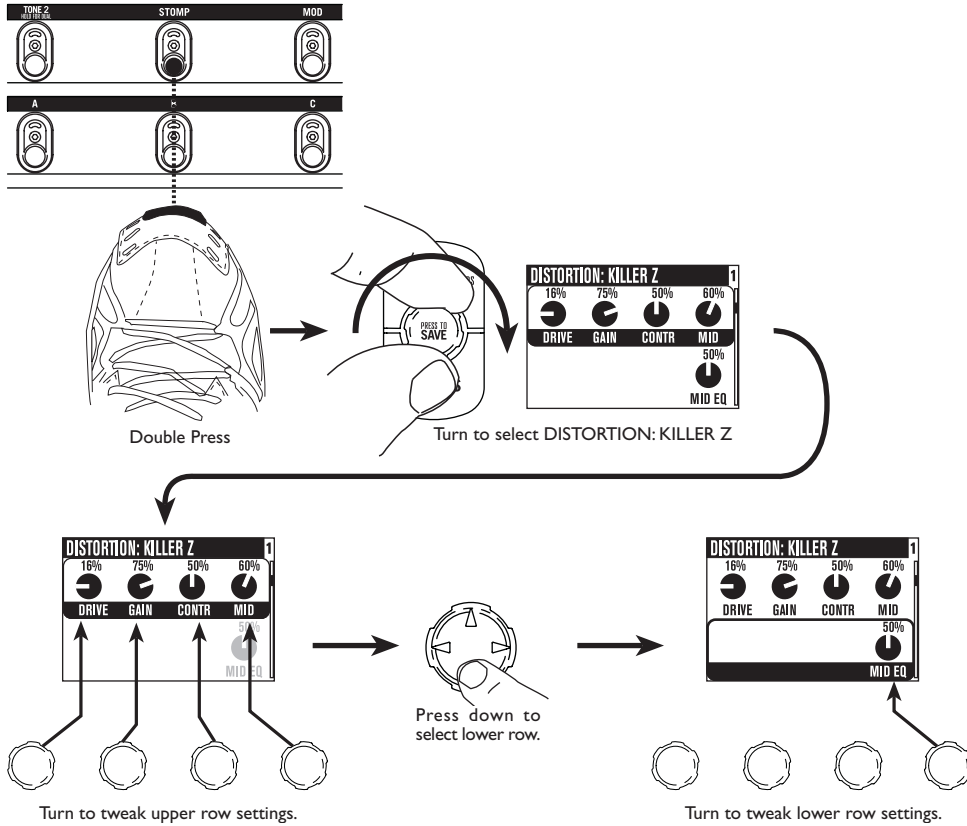

8. Show the Delay settings.

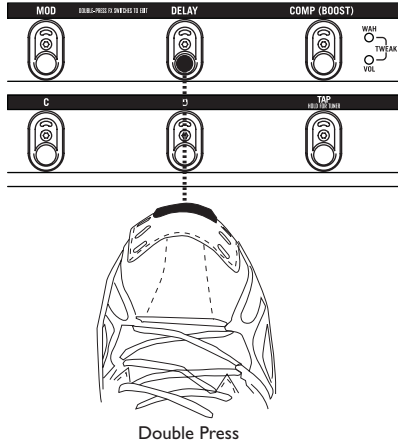

9. Set the Delay tempo, and set it to run post (after the Amp Model).

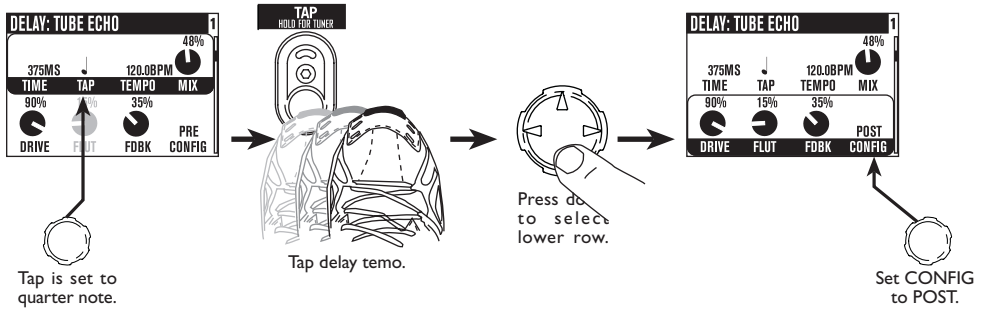

10. Select the EQ.

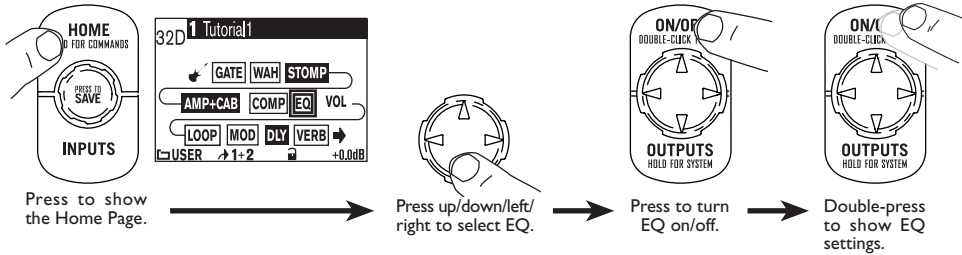

11. Tweak the EQ.

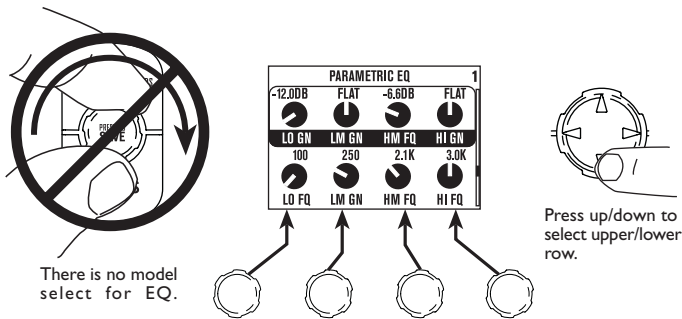

12. Turn both Tones on at once.

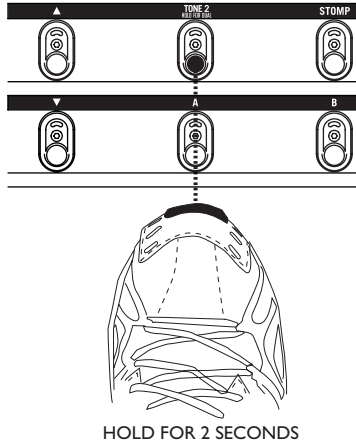

13. Load preset to Tone 2 Only.

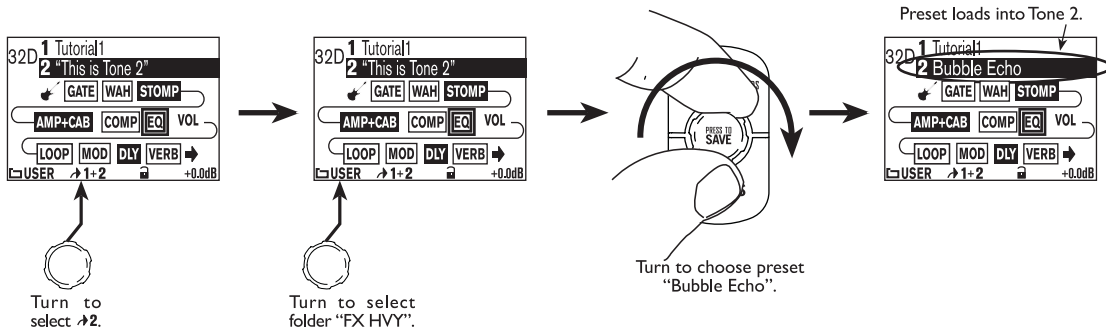

14. Select and Tweak Tone 1/Tone 2.

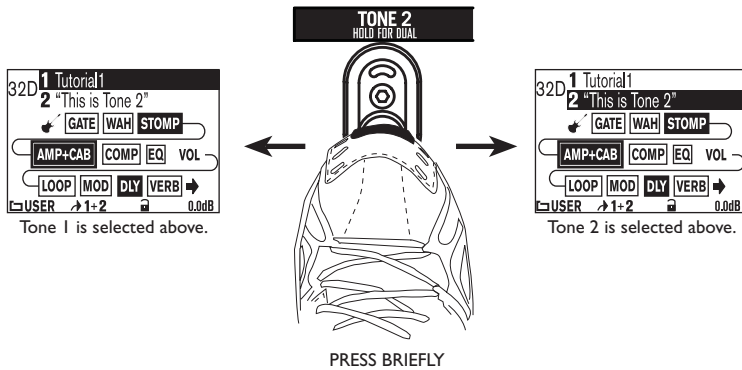

15. These knobs and footswitches control only one Tone at a time:

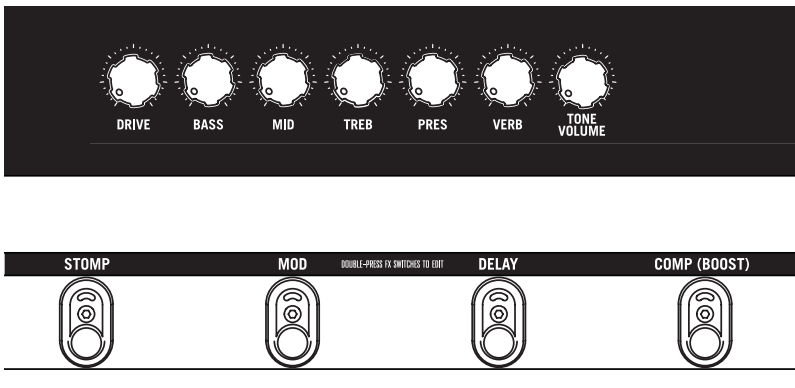

16. Tweak combined volume of Tone 1 + Tone 2.

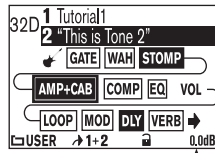

17. Save.

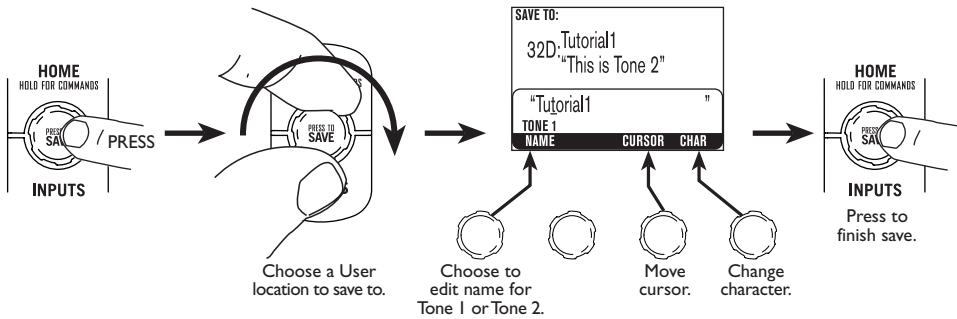

TUTORIAL: POD X3 & POD X3 Pro FOR GUITAR

1. Plug your guitar into Input 1.

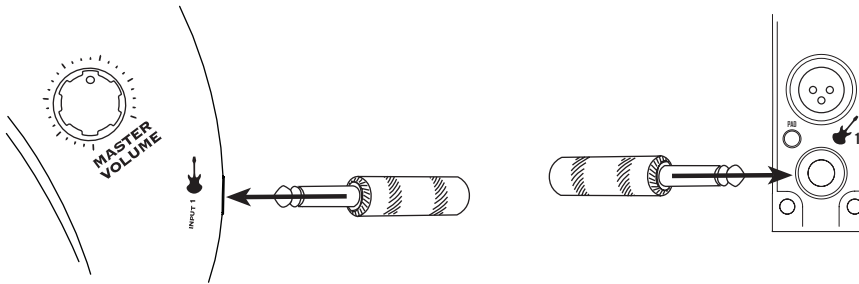

2. Turn on POD X3 or POD X3 Pro.

3. Recall User Preset “32D:Tutorial1”.

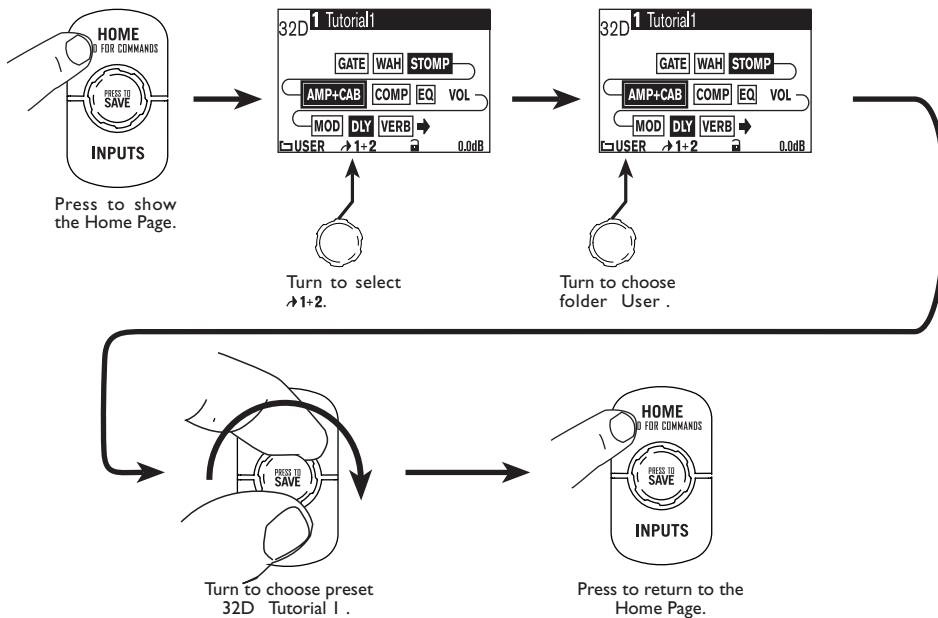

4. Turn on the Amp Model.

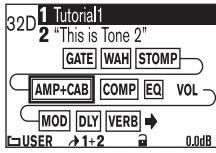

AMP+CAB is off (outlined).

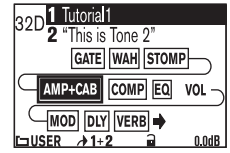
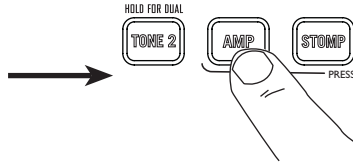

AMP+CAB is on (black).

5. Pick an Amp Model.

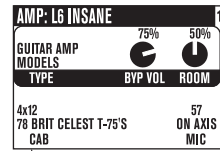
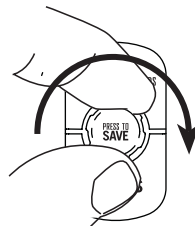
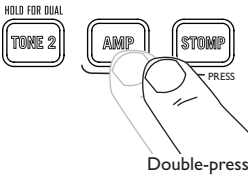

TYPE selects from Guitar, Bass and Pre-Amp Models.

6. Tweak the Amp Tone Controls.

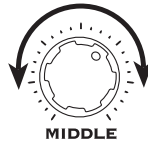
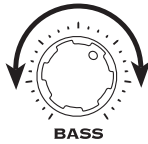
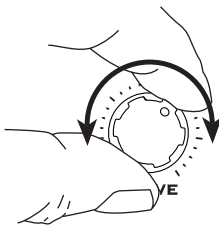

7. Pick a Stomp Model and tweak it.

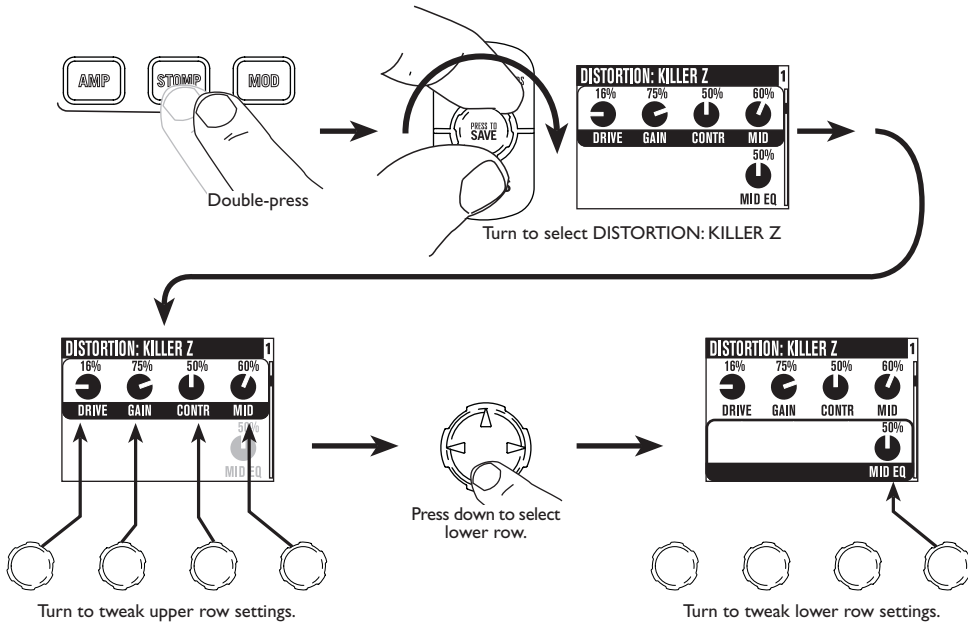

8. Show the Delay settings.

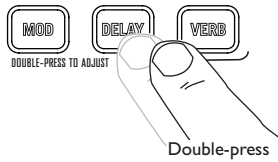

9. Set the Delay tempo, and set it to run post (after the Amp Model).

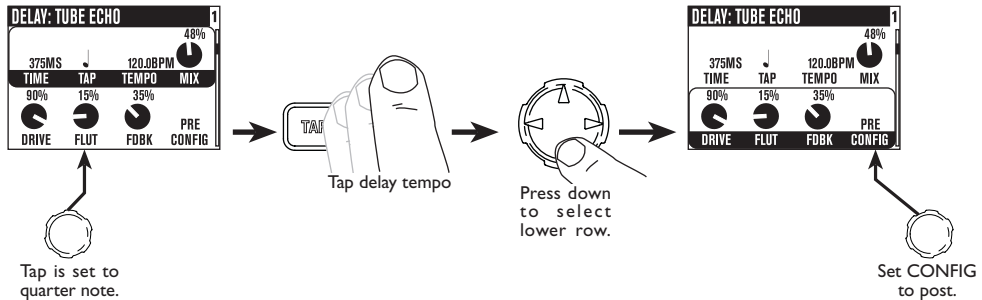

10. Select the EQ.

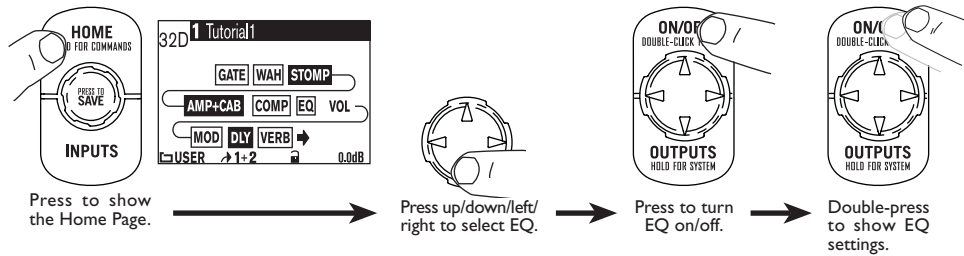

11. Tweak the EQ.

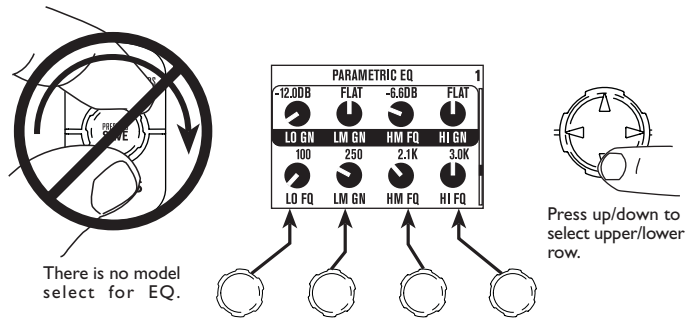

12. Turn both Tones on at once.

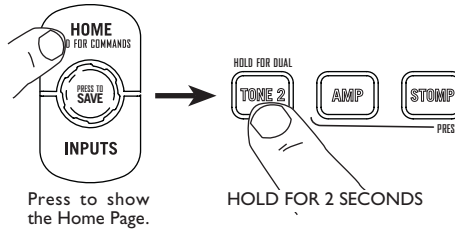

13. Load preset to Tone 2 only.

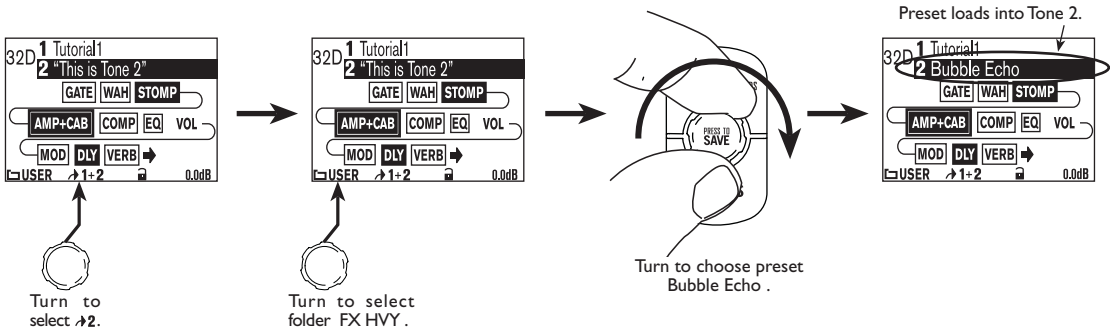

14. Select and tweak Tone 1/Tone 2.

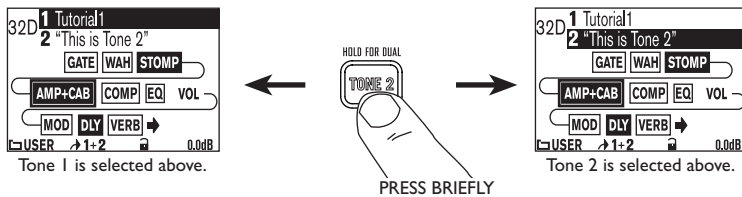

15. These knobs and buttons control only one Tone at a time:

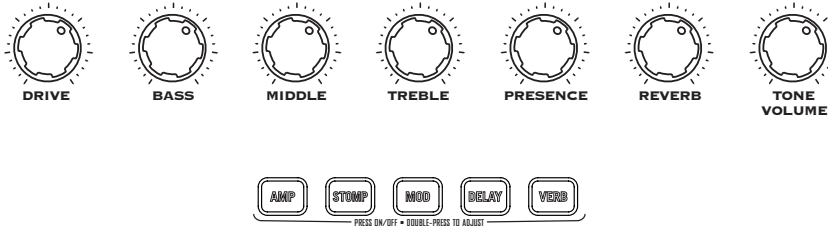

16. Tweak the combined volume of Tone 1 + Tone 2.

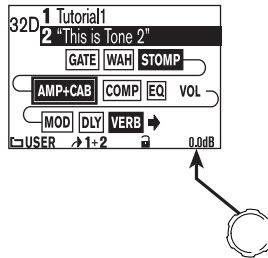

17. Save.

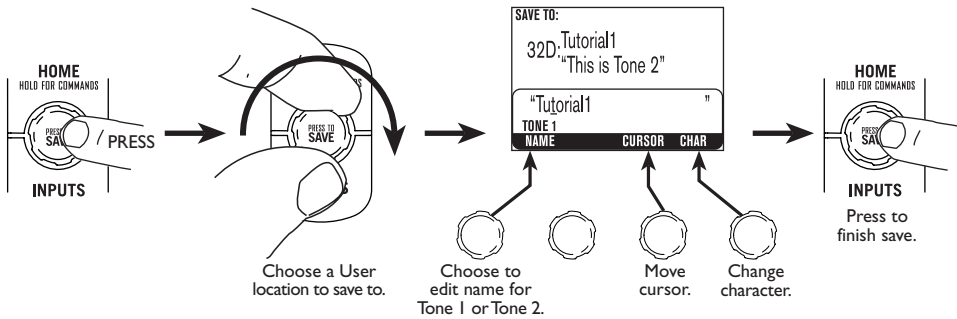

CONTROLS & CONNECTIONS

POD X3

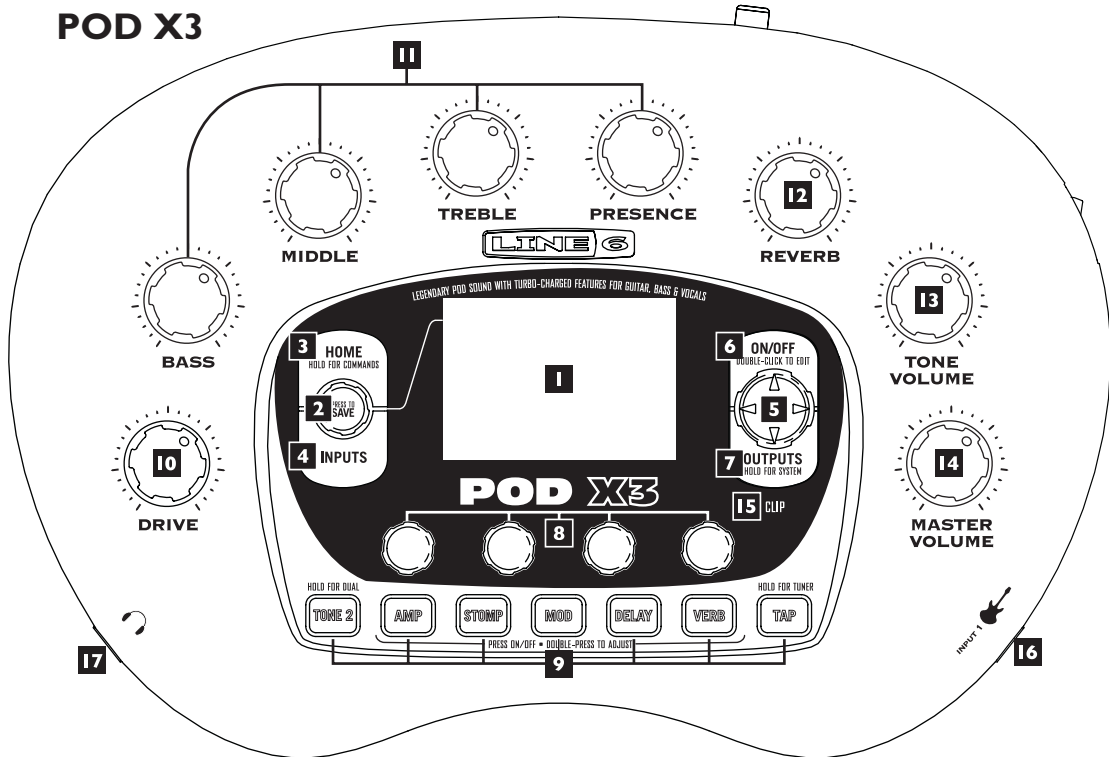

1 Display – the LCD (*liquid crystal display*) is your window into the power of POD X3. You'll see (2) types of “pages” in the display:

Home Page – the “Tone Path” Home Page shows you all the digital processing “blocks” that are working to deliver your great tone. For User Presets, you can also switch to a “Big User” Home Page, which shows you the bank and channel number where the preset is stored. The tone names that are loaded in the current preset, and the bank and channel number where the preset is stored are also displayed. You can get to the Home Page at any time by pressing the **Home** button. You can toggle between the two Home Pages by repeatedly pressing the **Home** button.

Edit Page – shows you all parameters available to tweak for a processing block or setup page.

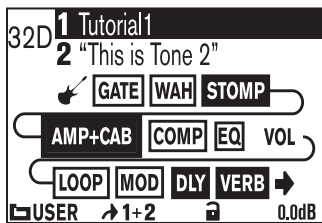

Tone Path Home Page

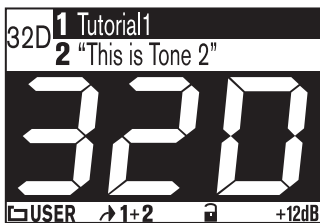

Big User Home Page
(available for User Presets only)

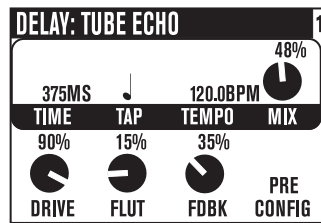

Edit Page

2 Select Knob – turning this knob will do different things depending on what page you’re on.

Home Page – turn to select presets. See Chapter 4 for all the details.

Edit Page – turn to pick a different Model. This works for the Amp, Stomp, Mod, Delay, Reverb, and Wah edit pages. Full details are in Chapter 5.

You can also press this knob to store your own tweaked-up sounds in POD X3. Just press, choose what to store and where to store it, and press the button again to complete the Save. Chapter 4 will fill you in.

3 Home / Hold for Commands – press to return to the Home Page. For User Presets, press repeatedly to toggle between the Tone Path Home Page and the Big User Home Page. Press and hold for 2 seconds to enter the Commands page. Full details are in Chapter 6.

4 Inputs – press to enter the Inputs setup page to configure which inputs you’re using. Full details are in Chapter 6.

5 4-way Nav – pressing this will do different things depending on what page you’re on.

Home Page – press **Up**, **Down**, **Left**, and **Right** to navigate to a processing block.

Edit Page – press **Up** and **Down** to move through each row of parameters available. You can also press **Left** and **Right** to move to the previous or next edit page.

6 On/Off – press to turn the selected processing block on or off (the blocks are on when the buttons are lit and the block on the Home Page is solid). Double-press to enter the processing block’s Edit page, where you can fine-tune the parameters for that block.

Press the **Home** button to leave the Edit page and return to the Home Page. Chapter 5 gives you details on all the Edit pages available.

7 Outputs / Hold for System – press to enter the Outputs setup page, where you can set up POD X3 for whatever you’re connecting it to. This is a very important step for getting the best sound out of your POD X3. Press and hold for 2 seconds to enter the System setup page. Full details are in Chapter 6.

8 Multi-function Knobs – turn any one of these knobs to adjust the corresponding parameter in the display.

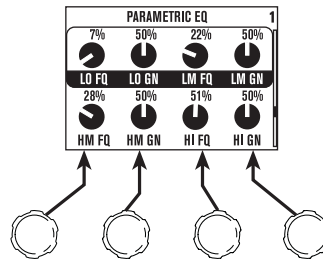

See Chapter 4 to learn about Home Page functions for these knobs.

9 Keypad – these buttons allow you to do the following:

Tone 2 / Hold for Dual – press to toggle between Tone 1 and Tone 2 (you’re editing Tone 2 when the button is lit). Press and hold to turn Dual Tone on or off. See Chapter 4 for more details, including info on using an FBV to control Dual Tone functions.

Amp, Stomp, Mod, Delay, Verb – press to turn the Amp, Stomp, Mod, Delay, and Reverb processing blocks on or off (the blocks are on when the buttons are lit). Double-press one of these buttons to tweak the block. For example, just press the **Stomp** button two times quickly and you’re instantly taken to the Stomp Box Edit Page. Press the **Home** button to leave the Edit Page and return to the Home Page. Chapter 5 gives you details on all the Edit Pages available.

Tap / Hold for Tuner – POD X3 allows you to control the time and speed of your Delay and/or Mod effects by simply tapping on this button. Just tap a few times here and the effects that are set to “lock” to that tempo will change to match what you tapped. There’s also a Tempo parameter in the effects’ Edit Pages, so you’ll see exactly what Tempo you’ve tapped. This is especially useful if you are trying to nudge your Tap

setting to just the right value. See Chapter 5 to learn how to set up effects to follow the tempo that you've tapped.

Press and hold the **Tap** button for 2 seconds to activate the tuner. You can also add footswitch tuner activation with an optional FBV foot controller.

10 Drive – controls how hard you're driving the input of the chosen Amp Model. Like the input volume control on a non-master volume guitar amp, higher settings give you more "dirt."

3•4

This knob, along with the **Tone Controls**, **Reverb**, and **Tone Volume** knobs, adjusts the Tone that is currently selected – Tone 1 or Tone 2. See Chapter 4 for more info on Dual Tone and how this all works.

11 Tone Controls – Bass, Middle, Treble, Presence. Just like any guitar amp. And when you change Amp Models, the response and interactivity of these controls change, too – so they act like the tone controls of the original amp that inspired the Amp Model you've selected.

12 Reverb – spin this knob to set the Reverb level of the Tone that is currently selected.

13 Tone Volume – this knob controls the relative volume level of the current Tone.

14 Master Volume – this controls the overall output level of POD X3 and also sets the headphone level. Changing the **Master Volume** level does not change your tone, so you can get the tone you want at any volume level. This setting is not saved when you store settings into one of the POD X3's memory locations.

When running into line level gear (like recorders, mixers and PA's), POD X3 will generally give the best signal-to-noise performance when you have the **Master Volume** control at max. With the **Master Volume** control turned down low, you may get extra hiss – which obviously isn't what you want – if you turn up your mixer or recorder's output to compensate. In order to allow you to set the **Master Volume** as high as possible when connecting to recording, mixing, and other studio gear, **be sure you are plugging POD X3's outputs into line level**, not microphone or guitar level inputs. Line level inputs should allow you to turn POD X3's **Master Volume** up all the way (or close to it) and thereby get the best sound possible. If your gear has inputs that function as mic/line level inputs, try to set the trim for those inputs to the minimum level, and POD X3's **Master**

Volume to maximum, when setting levels.

15 Clip Light – this lights when clipping is detected, which generally means unpleasantly distorted, bad sound. Try reducing the output level of the device that’s feeding your POD X3, or reducing the Tone Volume for Tone 1 or Tone 2, or the volume of Tone 1 + Tone 2 that can be adjusted from the right knob below the Home Page.

16 Input 1/Guitar In – plug your guitar or bass in here. You techies will want to know this is a mono, unbalanced connection. The **Inputs** page is where you assign whether this input feeds Tone 1, Tone 2 or both. See Chapter 6 for more info.

17 Phones – plug your headphones in here to avoid noise complaints from the neighbors (or the rest of your family). The volume is set by the **Master Volume** knob. Any time you use headphones, it important to be sure they’re not set for ridiculous volume before your slap them on your ears. Try a **Master Volume** knob setting of about 10 o’clock to start, then turn up from there if you need more volume.

To give you great sound through the headphones, your POD X3 automatically switches to Studio Mode whenever headphones are connected (for more on Studio Mode, see **Outputs** in Chapter 6.).

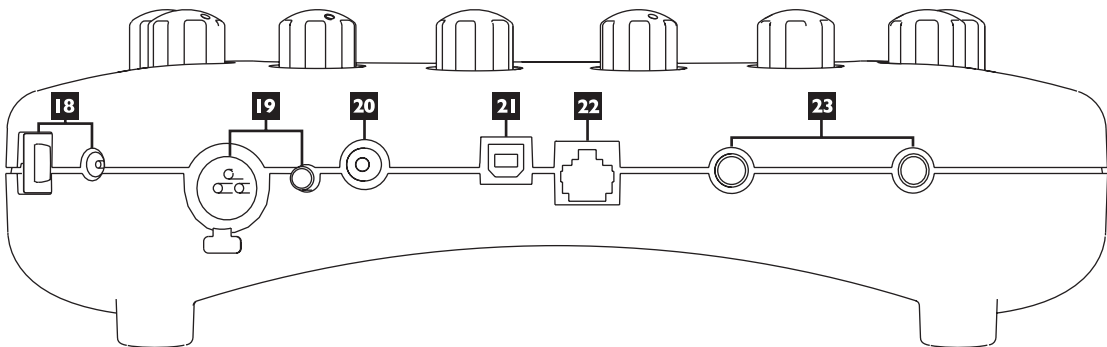

18 Power – connect the included PX-2 power pack and flip the switch here to bring your POD X3 to life.

19 Input 2/Microphone In and Trim – plug in your microphone here and use the Trim control to get a nice, healthy level. The **Inputs** page is where you assign whether this input feeds Tone 1, Tone 2 or both. See Chapter 6 for more info.

20 S/PDIF Out – this jack sends out 24-bit digital versions of the **Left & Right Outputs**. The **System** setup page lets you choose the sample rate and adjust the level. See Chapter 6 for the scoop.

21 USB 2.0 – POD X3's USB 2.0 jack lets you connect directly to a USB 2.0-equipped computer, and take advantage of many computer-powered features:

- Line 6 Monkey software makes it easy to install software and get updates. Install driver software with Line 6 Monkey, and POD X3 provides 8 audio inputs to your computer via USB:
- 1-2 is the main signal, configured on POD X3's Outputs page for Digital Outs.
- 3-4 is Tone 1 separately in stereo.
- 5-6 is Tone 2 separately in stereo.
- 7 is the sum of the inputs you've chosen for Tone 1.
- 8 is the sum of the inputs you've chosen for Tone 2.

You can also connect your headphones or powered speakers directly to POD X3 to hear your computer-generated audio, along with POD X3's real-time processing. See Chapter 8 for more info on USB 2.0 recording.

22 FBV Pedal – connect an optional foot controller here, including the FBV, FBV Shortboard, and FBV Express. The System page lets you set it all up. See Chapter 6 for details. Note that POD X3 does not work with the older Line 6 Floor Board or FBV2.

23 Left & Right Outputs – these balanced, 1/4-inch TRS (tip/ring/sleeve) connectors are ready to rock with pro +4 dBu balanced equipment. They will also work happily with unbalanced –10 dBV equipment and standard guitar cables. If you need mono output, you can use either one.

Join the Club!

Visit www.line6.com/club to register online and join the All Access club, the place to get:

- Free iTunes and MP3 Jam Tracks.
- Free loops for GarageBand, Acid, Reason and more.
- Free guitar lessons from LA session pros.
- Free chord and scale practice tools.
- Stay informed of contest and special offers.
- Access to discussion forums, software updates and more.

POD X3 Live

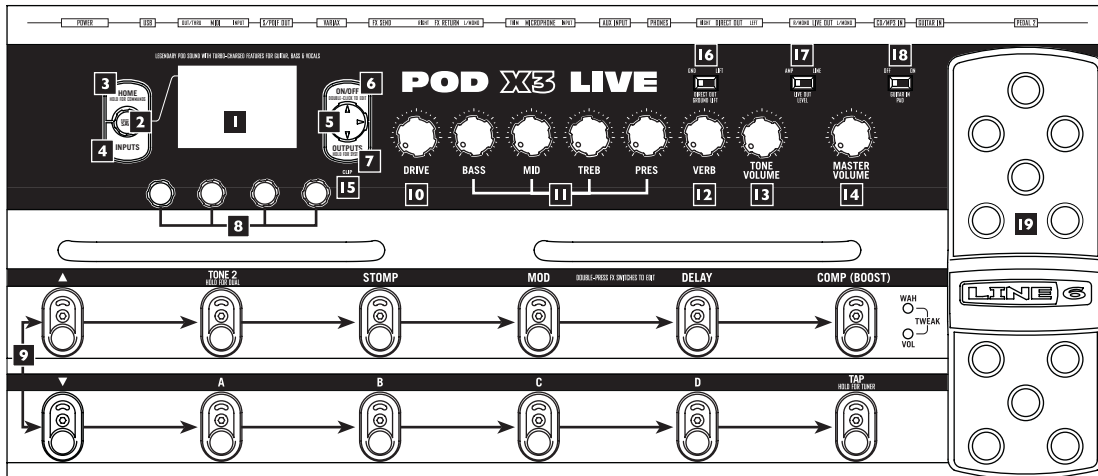

3•8

1 Display – the LCD (*liquid crystal display*) is your window into the power of POD X3 Live. You'll see (2) types of “pages” in the display:

Home Page – the “Tone Path” Home Page shows you all the digital processing “blocks” that are working to deliver your great tone. For User Presets, you can also switch to a “Big User” Home Page, which shows you the bank and channel number where the preset is stored. The tone names that are loaded in the current preset, and the bank and channel number where the preset is stored are also displayed. You can get to the Home Page at any time by pressing the **Home** button. You can toggle between the two Home Pages by repeatedly pressing the **Home** button.

Edit Page – shows you all parameters available to tweak for a processing block or setup page.

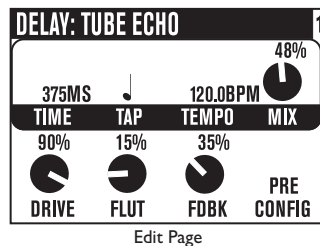
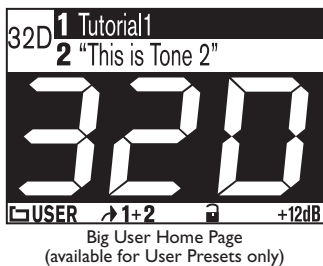
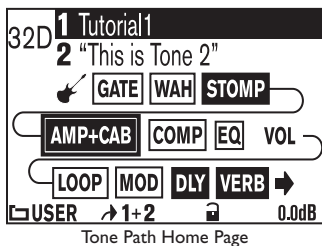

2 Select Knob – turning this knob will do different things depending on what page you're on.

Home Page – turn to select presets. See Chapter 4 for all the detail.

Edit Page – turn to pick a different Model. This works for the Amp, Stomp, Mod, Delay, Reverb, and Wah edit pages. Full details are in Chapter 5.

You can also press this knob to store your own tweaked-up sounds in POD X3 Live. Just press, choose what to store and where to store it, and press the button again to complete the Save. Chapter 4 will fill you in.

3 Home / Hold for Commands – press to return to the Home Page. For User Presets, press repeatedly to toggle between the Tone Path Home Page and the Big Number Home Page. Press and hold for 2 seconds to enter the Commands page. Full details are in Chapter 6.

4 Inputs – press to enter the Inputs setup page to configure which inputs you're using. Full details are in Chapter 6.

5 4-way Nav – pressing these buttons will also do different things depending on what page you're on.

Home Page – press **Up**, **Down**, **Left**, and **Right** to navigate to a processing block.

Edit Page – press **Up** and **Down** to move through each row of parameters available. You can also press the **Left** and **Right** to move to the previous or next processing block in the Tone path.

6 On/Off – press to turn the selected processing block on or off (the blocks are on when the buttons are lit and the block on the Home Page is solid). Double-press to enter the processing block's Edit page, where you can fine-tune the parameters for that block. Double-press the same button again (or press the **Home** button) to leave the Edit page and return to the Home Page. Chapter 5 gives you details on all the Edit pages available.

7 Outputs / Hold for System – press to enter the Outputs setup page, where you can set up POD X3 Live for whatever you're connecting it to. This is a very important step for getting the best sound out of your POD X3 Live. Press and hold for 2 seconds to enter the System setup page. Full details are in Chapter 6.

8 Multi-function Knobs – turn any one of these knobs to adjust the corresponding parameter in the display.

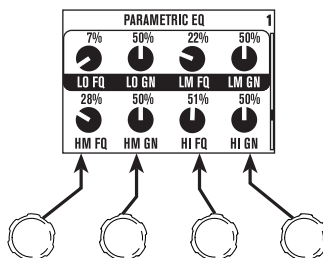

See Chapter 4 to learn about Home Page functions for these knobs.

9 Footswitches – these allow you to do the following:

Tone 2 / Hold for Dual – press to toggle between Tone 1 and Tone 2 (you’re editing Tone 2 when the footswitch is lit). Press and hold to turn Dual Tone on or off. See Chapter 4 for more details.

Stomp, Mod, Delay – turns the Stomp, Mod, and Delay processing blocks on or off (the blocks are on when the footswitches are lit). Double-press one of these footswitches to tweak the block. For example, just press the **Stomp** footswitch two times quickly and you’re instantly taken to the Stomp Box Edit Page. Double-press the same footswitch again (or press the **Home** button) to leave the Edit Page and return to the Home page. Chapter 5 gives you details on all the Edit Pages available.

Comp/Boost – turns the Compressor processing block on or off. Double-press to tweak the block. This footswitch can also be assigned to the Amp Model or Reverb processing block. See the **Pedal** info page in Chapter 5 for more details.

Bank Up, Down – these choose amongst POD X3 Live’s 32 banks of User presets. Once you’ve footswitched your way to a new bank, you’ll then also need to step on the **A, B, C** or **D** footswitch to actually load a preset from that bank. (We set things up this way so your audience won’t hear you switching through presets as you make your way to your next bank of sounds.)

A, B, C, D – the lights on these footswitches show you which of the Presets in the current User Bank is running. You can step on any of them to choose a different preset.

Tap / Hold for Tuner – POD X3 Live allows you to control the time and speed of your Delay and/or Mod effects by simply tapping on this footswitch. Tap a few times here, and the effects that are set to “lock” to that tempo will change to match what you tapped. There’s also a Tempo parameter in the effects’ Edit Pages, so you’ll see exactly what Tempo you’ve tapped. This is especially useful if you are trying to nudge your Tap setting to just the right value. See Chapter 5 to learn how to set up effects to follow the tempo that you’ve tapped.

Press and hold the **Tap** footswitch for 2 seconds to activate the tuner.

10 Drive – controls how hard you’re driving the input of the chosen Amp Model. Like the input volume control on a non-master volume guitar amp, higher settings give you more “dirt.”

This knob, along with the **Tone Controls**, **Verb**, and **Tone Volume** knobs, adjusts the Tone that is currently selected – Tone 1 or Tone 2. See Chapter 4 for more info on Dual Tone and how this all works.

11 Tone Controls – Bass, Mid, Treb, Pres. Just like any guitar amp. And when you change Amp Models, the response and interactivity of these controls change, too – so they act like the tone controls of the original amp that inspired the Amp Model you’ve selected.

12 Reverb – spin this knob to set the Reverb level of the Tone that is currently selected.

13 Tone Volume – this knob controls the relative volume level of the current Tone.

14 Master Volume – this controls the overall output level of POD X3 Live and also sets the headphone level. Changing the **Master Volume** level does not change your tone, so you can get the tone you want at any volume level. This setting is not saved when you store settings into one of the POD X3 Live’s memory locations.

POD X3 Live will generally give the best signal-to-noise performance when you have the **Master Volume** control at max. With the **Master Volume** control turned down low, you may get extra hiss – which obviously isn’t what you want – if you turn up your mixer or recorder’s output to compensate. In order to allow you to set the **Master Volume** as high as possible when connecting to recording, mixing, and other studio gear, **be sure you are plugging POD X3 Live’s 1/4-inch outputs into line level**, not microphone

or guitar level inputs. Line level inputs should allow you to turn POD X3 Live's **Master Volume** up all the way (or close to it) and thereby get the best sound possible. If your gear has inputs that function as mic/line level inputs, try to set the trim for those inputs to the minimum level, and POD X3 Live's **Master Volume** to maximum, when setting levels.

15 Clip Light – this lights when clipping is detected, which generally means unpleasantly distorted, bad sound. Try reducing the output level of the device that's feeding your POD X3, or reducing the Tone Volume for Tone 1 or Tone 2, or the volume of Tone 1 + Tone 2 that can be adjusted from the right knob below the Home Page.

16 Direct Out Ground Lift – this switch lets you lift the grounds of POD X3 Live's XLR Direct Outs. This can be handy if you get an audible hum caused by a ground loop when connecting to other grounded equipment.

17 Live Out Level – this switch sets the level for the **Live Outputs**. When set to *Amp*, the **Live Outputs** are ready for connection to an on-stage amp. When set to *Line*, they're ready to plug into a mixer or recorder with line level inputs.

18 Guitar In Pad – the *Off* setting of this switch is appropriate for most guitars. If you see the **Clip** light coming on, that means you're overloading POD X3 Live's input. If that happens frequently, try the *On* setting here. This switches in input circuitry that's appropriate for hotter signals output by some guitars with active pickups, or from keyboards and other sources.

19 Onboard Pedal – the lights to the left of this pedal show whether the pedal will operate the Wah effect, Volume Pedal, or (when both lights are lit) Tweak. When operating the Wah, you can press hard with your toe at the top of the pedal, and the wah – as well as the wah light to the left of the pedal – will turn on and off. To learn how to change what the pedal controls, see page Chapter 6.

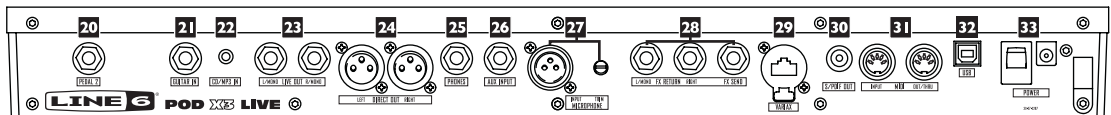

20 Pedal 2 – connect a standard expression pedal, such as the Line 6 EX-1, and you'll be able to assign it to control the Volume Pedal or Effect Tweak functions. See Chapter 6 for the detail on that.

21 Guitar In – plug your guitar or bass in here. You techies will want to know this is a mono, unbalanced connection. The **Guitar In Pad** switch sets the sensitivity of this jack. The **Inputs** page is where you assign whether this input feeds Tone 1, Tone 2 or both. See Chapter 6 for more info.

22 CD/MP3 In – connect a CD player, MP3 player, drum machine or other device here, and you'll hear it at POD X3 Live's **Phones**, **Direct Out**, and **Live Out**.

23 Live Out – the unbalanced 1/4-inch connectors here get your POD X3 Live's sound to a guitar amplifier, recorder, mixer or PA system.

The **Output** display pages configure these outputs for Studio or Live use. In Studio Mode, they're ready to plug into a recorder with unbalanced –10 dBV inputs. In Live Mode, they don't have speaker simulation, and are ready for connection to an on-stage power amp. Whichever you choose, the front panel **Master Volume** knob determines how much signal you'll get at these jacks. You can use either jack as a mono output, by the way.

24 Direct Out – these balanced XLR connectors always provide studio-quality sound with speaker/microphone/room simulation ideal for direct recording and as a direct send to the house mixer or PA when playing live.

As detailed in Chapter 6, the **System** page lets you disable Master Volume control for these outputs, so you can make on-stage adjustments to the 1/4-inch outputs feeding an amp without affecting the levels sent to the house sound mixer or PA.

25 Phones – plug your headphones in here to avoid noise complaints from the neighbors (or the rest of your family). The volume is set by the **Master Volume** knob. Any time you use headphones, it's important to be sure they're not set for ridiculous volume before you slap them on your ears. Try a **Master Volume** knob setting of about 10 o'clock to start, then turn up from there if you need more volume.

26 Aux Input – this mono, unbalanced 1/4-inch input can be used for a second guitar or just about any other instrument. The **Inputs** page is where you assign whether this input feeds Tone 1, Tone 2 or both. See Chapter 6 for more info.

27 Microphone Input and Trim – plug in your microphone here and use the Trim control to get a nice, healthy level. The **Inputs** page is where you assign whether this input feeds Tone 1, Tone 2 or both. See Chapter 6 for more info.

28 Effects Loop – the Effects Loop provides a mono **FX Send** and a stereo **FX Return**, operating at approximately 19.5 Volts peak-to-peak, making it optimal for line level devices. The loop can also be used with most stomp boxes by adjusting the send and return levels. Use the **Left Return** jack for mono return. The loop can run pre or post Amp Model, and if nothing is connected to it, POD X3 Pro is smart enough to disable the loop so you still get sound. See Chapter 5 for details.

29 Variax – this input provides power and a direct digital audio connection between a Line 6 Variax guitar or bass and the POD X3 Live. The **Inputs** page is where you assign whether this input feeds Tone 1, Tone 2 or both. See Chapter 6 for more info.

Be sure to keep the protective plastic cap on this connection when it's not connected to a Variax, so you won't damage it by mistakenly inserting a 1/4-inch guitar cable or other connection. When you are ready to connect a Variax, use only Line 6 supplied Variax-compatible cables – not standard Ethernet or other cables – to avoid damage to the jack.

You can learn more about the Variax family of guitars, each one giving you the sound of an entire guitar collection in one instrument, at www.line6.com.

30 S/PDIF Out – this jack sends out 24-bit digital versions of the **Direct Out** signals. The **System** setup screen lets you choose the sample rate and adjust the level. See Chapter 6 for the scoop.

31 MIDI – connect POD X3 Live to your MIDI equipment to send and receive Program Change Messages for selecting Presets. POD X3 Live's MIDI Out connects to another device's MIDI In; its MIDI In goes to another device's MIDI Out. Chapter 6 has info on setting your MIDI Channel for communication. Visit www.line6.com/manuals for more comprehensive MIDI CC information.

32 USB 2.0 – POD X3 Live's USB 2.0 jack lets you connect directly to a USB 2.0-equipped computer, and take advantage of many computer-powered features:

- Line 6 Monkey software makes it easy to install software and get updates. Install driver software with Line 6 Monkey, and POD X3 provides 8 audio inputs to your computer via USB:
- 1-2 is the main signal, configured on POD X3's Outputs page for Digital Outs.
- 3-4 is Tone 1 separately in stereo.
- 5-6 is Tone 2 separately in stereo.

- 7 is the sum of the inputs you've chosen for Tone 1.
- 8 is the sum of the inputs you've chosen for Tone 2.

You can also connect your headphones or powered speakers directly to POD X3 to hear your computer-generated audio, along with POD X3's real-time processing. See Chapter 8 for more info on USB 2.0 recording.

33 Power – connect the included PX-2 power pack and flip the switch here to bring your POD X3 Live to life.

Join the Club!

Visit www.line6.com/club to register online and join the All Access club, the place to get:

- Free iTunes and MP3 Jam Tracks.
- Free loops for GarageBand, Acid, Reason and more.
- Free guitar lessons from LA session pros.
- Free chord and scale practice tools.
- Stay informed of contest and special offers.
- Access to discussion forums, software updates and more.

POD X3 Pro

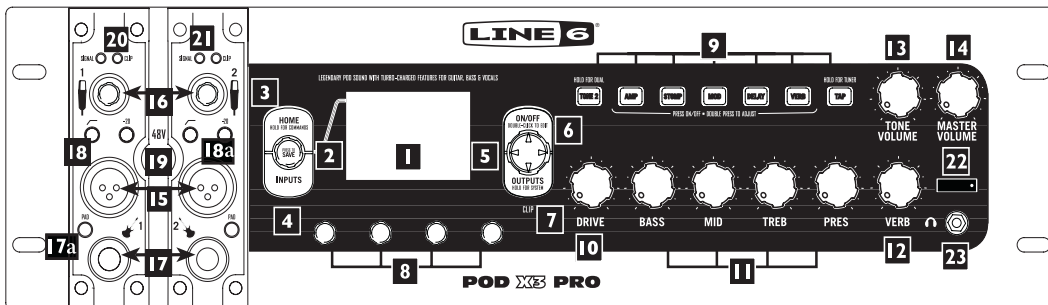

1 Display – the LCD (*liquid crystal display*) is your window into the power of POD X3 Pro. You'll see (2) types of “pages” in the display:

Home Page – the “Tone Path” Home Page shows you all the digital processing “blocks” that are working to deliver your great tone. For User Presets, you can also switch to a “Big User” Home Page, which shows you the bank and channel number where the preset is stored. The tone names that are loaded in the current preset, and the bank and channel number where the preset is stored are also displayed. You can get to the Home Page at any time by pressing the **Home** button. You can toggle between the two Home Pages by repeatedly pressing the **Home** button.

Edit Page – shows you all parameters available to tweak for a processing block or setup page.

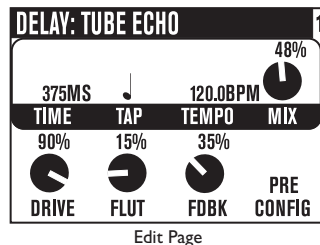
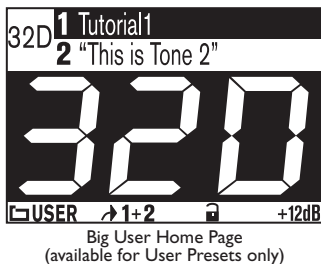
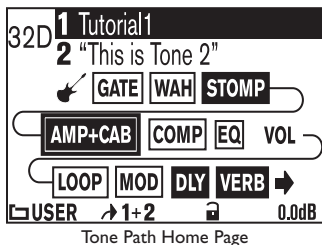

2 Select Knob – turning this knob will do different things depending on what page you're on.

Select Knob Home Page – turn to select presets. See Chapter 4 for all the details.

Edit Page – turn to pick a different Model. This works for the Amp, Stomp, Mod, Delay, Reverb, and Wah edit pages. Full details are in Chapter 5.

You can also press this knob to store your own tweaked-up sounds in POD X3 Pro. Just press, choose what to store and where to store it, and press the button again to complete the Save. Chapter 4 will fill you in.

3 Home / Hold for Commands – press to return to the Home Page. For User Presets, press repeatedly to toggle between the Tone Path Home Page and the Big User Home Page. Press and hold for 2 seconds to enter the Commands page. Full details are in Chapter 6.

4 Inputs – press to enter the Inputs setup page to configure which inputs you're using. Full details are in Chapter 6.

5 4-way Nav – pressing this will do different things depending on what page you're on.

Home Page – press **Up**, **Down**, **Left**, and **Right** to navigate to a processing block.

Edit Page – press **Up** and **Down** to move through each row of parameters available. You can also press **Left** and **Right** to move to the previous or next edit page.

6 On/Off – press to turn the selected processing block on or off (the blocks are on when the buttons are lit and the block on the Home Page is solid). Double-press to enter the processing block's Edit page, where you can fine-tune the parameters for that block. Press the **Home** button to leave the Edit page and return to the Home Page. Chapter 5 gives you details on all the Edit pages available.

7 Outputs / Hold for System – press to enter the Outputs setup page, where you can set up POD X3 Pro for whatever you're connecting it to. This is a very important step for getting the best sound out of your POD X3 Pro. Press and hold for 2 seconds to enter the System setup page. Full details are in Chapter 6.

8 Multi-function Knobs – turn any one of these knobs to adjust the corresponding parameter in the display.

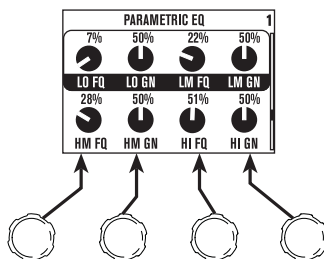

See Chapter 4 to learn about Home Page functions for these knobs.

9 Keypad – these buttons allow you to do the following:

Tone 2 / Hold for Dual – press to toggle between Tone 1 and Tone 2 (you’re editing Tone 2 when the button is lit). Press and hold to turn Dual Tone on or off. See Chapter 4 for more details, including info on using an FBV to control Dual Tone functions.

Amp, Stomp, Mod, Delay, Verb – press to turn the Amp, Stomp, Mod, Delay, and Reverb processing blocks on or off (the blocks are on when the buttons are lit). Double-press one of these buttons to tweak the block. For example, just press the **Stomp** button two times quickly and you’re instantly taken to the Stomp Box Edit Page. Press the **Home** button to leave the Edit Page and return to the Home Page. Chapter 5 gives you details on all the Edit Pages available.

Tap / Hold for Tuner – POD X3 Pro allows you to control the time and speed of your Delay and/or Mod effects by simply tapping on this button. Just tap it a few times and the effects that are set to “lock” to that tempo will change to match what you tapped. There’s also a Tempo parameter in the effects’ Edit Pages, so you’ll see exactly what Tempo you’ve tapped. This is especially useful if you are trying to nudge your Tap, setting to just the right value. See Chapter 5 to learn how to set up effects to follow the tempo you’ve tapped.

Press and hold the **Tap** button for 2 seconds to activate the tuner. You can also add footswitch tuner activation with an optional FBV foot controller.

10 Drive – controls how hard you’re driving the input of the chosen Amp Model. Like the input volume control on a non-master volume guitar amp, higher settings give you more “dirt.”

This knob, along with the **Tone Controls**, **Reverb**, and **Tone Volume** knobs, adjusts the Tone that is currently selected – Tone 1 or Tone 2. See Chapter 4 for more info on Dual Tone and how this all works.

11 Tone Controls – Bass, Middle, Treble, Presence. Just like any guitar amp. And when you change Amp Models, the response and interactivity of these controls change, too—so they act like the tone controls of the original amp that inspired the Amp Model you’ve selected.

12 Reverb – spin this knob to set the Reverb level of the Tone that is currently selected.

13 Tone Volume – this knob controls the current Tone’s relative volume level.

14 Master Volume – this controls the overall output level of POD X3 Pro and also sets the headphone level. Changing the **Master Volume** level does not change your tone, so you can get the tone you want at any volume level. This setting is not saved when you store settings into one of the POD X3 Pro’s memory locations.

When running into line level gear (like recorders, mixers and PA’s), POD X3 Pro will generally give the best signal-to-noise performance when you have the **Master Volume** control at max. With the **Master Volume** control turned down low, you may get extra hiss – which obviously isn’t what you want – if you turn up your mixer or recorder’s output to compensate. In order to allow you to set the **Master Volume** as high as possible when connecting to recording, mixing, and other studio gear, **be sure you are plugging POD X3 Pro’s outputs into line level**, not microphone or guitar level inputs. Line level inputs should allow you to turn POD X3 Pro’s **Master Volume** up all the way (or close to it) and thereby get the best sound possible. If your gear has inputs that function as mic/line level inputs, try to set the trim for those inputs to the minimum level, and POD X3 Pro’s **Master Volume** to maximum, when setting levels.

15 Microphone Input – plug in your microphone here. The **Inputs** page is where you assign whether this input feeds Tone 1, Tone 2 or both. See Chapter 6 for more info.

16 Trim Control – use the **Trim Control** to get a nice, healthy level.

17 Guitar In – plug your guitar or bass in here. It’s a mono, unbalanced connection. The **Inputs** page is where you assign whether this input feeds Tone 1, Tone 2 or both. See Chapter 6 for details.

17a Guitar In Pad – engage this Pad to tame hotter signals at the Guitar In jack when you use guitars with active pickups or other high output sources.

18 Low Cut Filter – push this button in to engage the Low Cut Filter for the Mic Input. It cuts 75Hz and below, which is useful for eliminating rumble from mic sources.

18a Mic Pad – for hot mics, engage this pad to attenuate the Mic Input by -20dB.

19 Phantom Power – pushing in this button activates 48V Phantom Power for both Channel Strip Mic Inputs. An LED will light when Phantom Power is activated.

20 Clip Light – this lights when input clipping is detected at the Channel Strip Mic or Guitar Inputs. To avoid clipping, engage the Mic Pad or Guitar Pad or reduce the output level of the device that's feeding your POD X3 Pro. Another Clip Light for Tone Volume clipping is located under the Outputs button, as described on Page 3•5, item 15.

21 Signal Present LED – this LED will light when an input signal is present.

22 Power Switch – flip the switch here to bring your POD X3 Pro to life.

23 Phones – plug your headphones in here to avoid noise complaints from the neighbors (or the rest of your family). The volume is set by the **Master Volume** knob. Any time you use headphones, it important to be sure they're not set for ridiculous volume before your slap them on your ears. Try a **Master Volume** knob setting of about 10 o'clock to start, then turn up from there if you need more volume.

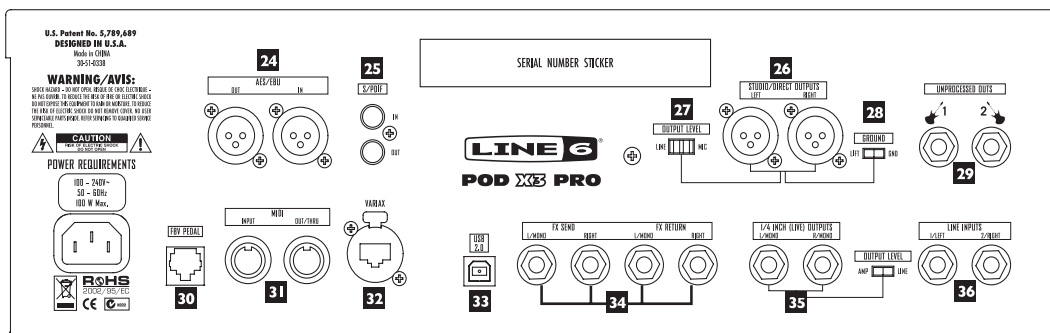

24 AES/EBU I/O – the AES/EBU Out jack sends 24-bit digital versions of the **Direct Out** signals. The **System** setup screen lets you choose the sample rate and adjust the level. See Chapter 6 for details. The **AES/EBU In** jack receives 24-bit digital audio.

25 S/PDIF I/O – the S/PDIF Out jack sends out 24-bit digital versions of the Direct Out signals. The System setup screen lets you choose the sample rate and adjust the level. See Chapter 6 for details. The S/PDIF In jack receives 24-bit digital audio.

26 Studio/Direct Out – these balanced XLR connectors provide speaker/microphone/room simulation, perfect in the studio for pro-quality sound or as a direct send to a house mixer or PA when playing live.

27 Output Level – use this switch to set the output level of POD X3 Pro's XLR Direct Outs to Mic or Line level.

28 Direct Out Ground Lift – this switch lets you lift the grounds of POD X3 Pro's XLR Direct Outs. This can be handy if you get an audible hum caused by a ground loop when connecting to other grounded equipment.

29 Unprocessed Out – these unbalanced 1/4-inch connectors give you an unprocessed guitar signal, tapped off of your POD X3 Pro's guitar input. This is perfect for recording when you want to re-amp or use plugins to process your guitar track.

30 FBV Pedal – connect an optional foot controller here, including the FBV, FBV Shortboard, and FBV Express. The System page lets you set it all up. See Chapter 6 for details. Note that POD X3 Pro doesn't work with the older Line 6 Floor Board or FBV2.

31 MIDI – connect your POD X3 Pro to your MIDI equipment to send and receive Program Change Messages for selecting Presets. POD X3 Pro's MIDI Out connects to another device's MIDI In; its MIDI In goes to another device's MIDI Out. Chapter 6 has info on setting your MIDI Channel for communication. Visit www.line6.com/manuals for more comprehensive MIDI CC information.

32 Variax – this input provides power and a direct digital audio connection between a Line 6 Variax guitar or bass and the POD X3 Pro. The Inputs page is where you assign whether this input feeds Tone 1, Tone 2 or both. See Chapter 6 for more info.

Be sure to keep the protective plastic cap on this connection when it's not connected to a Variax, so you won't damage it by mistakenly inserting a 1/4-inch guitar cable or other connection. When you are ready to connect a Variax, use only Line 6 supplied Variax-compatible cables – not standard Ethernet or other cables – to avoid damage to the jack.

You can learn more about the Variax family of guitars, each one giving you the sound of an entire guitar collection in one instrument, at www.line6.com.

33 USB 2.0 – POD X3 Pro’s USB 2.0 jack lets you connect directly to a USB 2.0-equipped computer, and take advantage of many computer-powered features:

- Line 6 Monkey software makes it easy to install software and get updates. Install driver software with Line 6 Monkey, and POD X3 Pro provides 8 audio inputs to your computer via USB:
- 1-2 is the main signal, configured on POD X3 Pro’s **Outputs** page for Digital Outs.
- 3-4 is Tone 1 separately in stereo.
- 5-6 is Tone 2 separately in stereo.
- 7 is the sum of the inputs you’ve chosen for Tone 1.
- 8 is the sum of the inputs you’ve chosen for Tone 2.

You can also connect your headphones or powered speakers directly to POD X3 Pro to hear your computer-generated audio, along with POD X3 Pro’s real-time processing. See Chapter 8 for more info on USB 2.0 recording.

34 Effects Loop – the Effects Loop provides two jacks for stereo **FX Send** and two for stereo **FX Return**, operating at approximately 19.5 Volts peak-to-peak, making it optimal for line level devices. The loop can also be used with most stomp boxes by adjusting the send and return levels. Use the **Left Return** jack for mono return. The loop can run pre or post Amp Model, and if nothing is connected to it, POD X3 Pro is smart enough to disable the loop so you still get sound. See Chapter 5 for details.

35 1/4” (Live) Outputs – these unbalanced jacks get your POD X3 Pro’s sound to a guitar amp, recorder, mixer or PA. You can select Amp or Line output level via the switch to the right of the 1/4” jacks.

The **Output** display pages configure these outputs for Studio or Live use. In Studio Mode, they’re ready to plug into a recorder with unbalanced –10 dBV inputs. In Live Mode, they don’t have speaker simulation, and are ready for connection to an on-stage power amp. Whichever you choose, the front panel **Master Volume** knob determines how much signal you’ll get at these jacks. You can use either jack as a mono output, by the way.

As detailed in Chapter 6, the **System** page lets you disable Master Volume control for these outputs, so you can make on-stage adjustments to the 1/4-inch outputs feeding an amp without affecting the levels sent to the house sound mixer or PA.

36 Line Inputs – these two unbalanced 1/4-inch inputs can be used for a second guitar or just about any other instrument or line inputs. The **Inputs** page is where you assign whether these inputs feed Tone 1, Tone 2 or both. See Chapter 6 for more info.

Join the Club!

Visit www.line6.com/club to register online and join the All Access club, the place to get:

- Free iTunes and MP3 Jam Tracks.
- Free loops for GarageBand, Acid, Reason and more.
- Free guitar lessons from LA session pros.
- Free chord and scale practice tools.
- Stay informed of contest and special offers.
- Access to discussion forums, software updates and more.

GETTING AROUND, TONES & TUNER

POD X3, POD X3 Live and POD X3 Pro allow you to completely tweak your tone, giving you the ability to dial-in just about any sound you can imagine. More importantly, we've come up with an amazingly straight-forward way for you to take total control of your sound. It all starts at the Home Page.

Home Page

You can get to POD X3, POD X3 Live and POD X3 Pro's Home Page at any time by pressing the **Home** button. There are actually two versions of the Home Page, the "Tone Path" Home Page and the "Big User" Home Page:

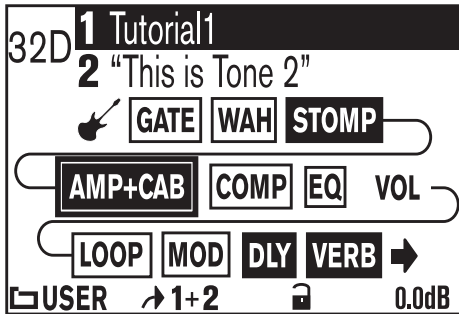

Tone Path Home Page



Big User Home Page
(available for User Presets only)

If the currently-loaded preset is from the User folder, you can toggle between these two Home Page displays by repeatedly pressing the **Home** button. Otherwise, the Tone Path Home Page will be the only one available. The Big User Home Page is handy when you're on stage – you'll be able to clearly see which User preset is loaded.

To the left of the Tone names is the bank and channel number ("32D", for example) if this is a User preset, or just a number if it's from one of the other preset folders.

The Tone Path Home Page also shows the Tone Path, which includes all the digital processing "blocks" that are working to deliver you great tone. The blocks include:

Getting Around, Tones & Tuner

- Amp+Cab
- Gate
- Wah
- Stomp
- EQ
- Comp
- Loop (POD X3 Live & Pro)
- Mod
- Dly
- Rev
- Vol (always on)

Each block in the path can be selected, turned on or off (except Volume), and tweaked to your liking. To select a block from the **Home Page**, use the **4-way Nav** button to get to the one you want. When a block is selected, you'll see that it gets a frame around it:

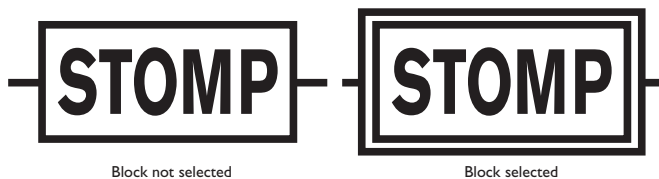

Once you select a block, you can press the **On/Off** button to turn that block on and off. The color of the block tells you whether it's off (inactive) or on (active):



To tweak a block, select it and double-press the **On/Off** button. This will open up its Edit Page, where you can use the **Select** knob to pick Models (where available) and the **Multi-function** knobs to change the corresponding parameters as desired:

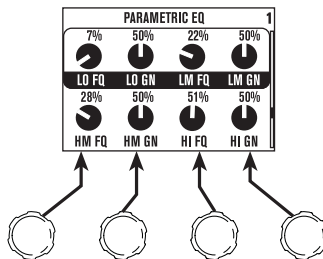

If there are multiple rows or multiple pages of parameters in an Edit Page, you can use the **Up** and **Down** buttons to get to them all.

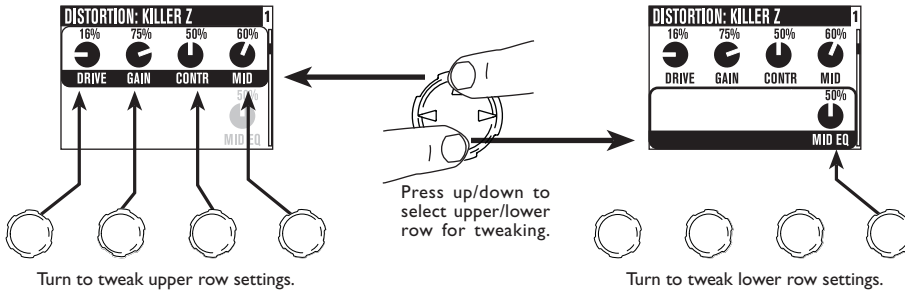

From any Edit page, you can also use the **Left** and **Right** buttons to step through the other Edit Pages, in this order:

AMP > STOMP > MOD > DLY > VERB > GATE > COMP > EQ > WAH > VOL > LOOP (POD X3 Live & POD X3 Pro only)

To return to the Home Page from an Edit Page, you can either press the **Home** button or double-press the **On/Off** button.

By the way, you can also directly edit and turn blocks on or off using the POD X3 and POD X3 Pro **Keypad** or POD X3 Live **Footswitches**. You know the drill—press to turn blocks on or off, and double-press to tweak.

Many of these blocks can be configured to be Pre or Post, so their location in the Home Page can visually change depending on how they're assigned.

See Chapter 5 for details on every block's Edit Page and the parameters available to tweak.

The Dual Tone Concept

One of the most powerful features of POD X3, POD X3 Live and POD X3 Pro is Dual Tone capability. What is Dual Tone, you ask? There are actually two (2) completely independent Tone paths available in POD X3, POD X3 Live and POD X3 Pro! This allows you to:

Process two (2) completely independent Tones for two separate inputs at the same time, such as your guitar plus a microphone. We like to refer to these as tone “Pairs”.

or

Use two (2) completely independent Tones on a single input. This is like running through (2) amps at once! We call these tone “Blends”.

or

Set up one sound on Tone 1, and a different sound on Tone 2, and switch between them instantly, with seamless transitions including delay and reverb trails. We like to refer to this as “Alternating” tones.

There are essentially (3) steps to getting Dual Tone going on POD X3, POD X3 Live and POD X3 Pro:

1. Assign inputs. To assign inputs to each Tone, press the **Inputs** button and select the input or combination of inputs to feed Tone 1 and Tone 2. Full details are available in Chapter 5.

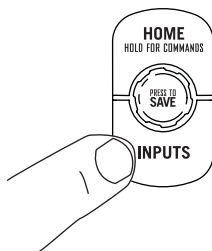

2. Choose whether you want both Tones on at the same time, or just one Tone, by holding the **Tone 2** button (POD X3 & POD X3 Pro) or the **Tone 2** footswitch (POD X3 Live) for two seconds.

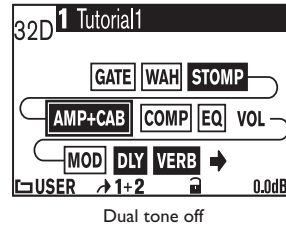
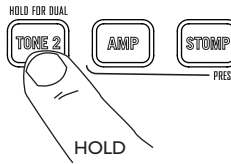
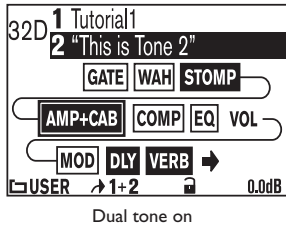

- Tweak your Tones. From the Home Page, briefly pressing the **Tone 2** button (POD X3 & POD X3 Pro) or stepping on the **Tone 2** footswitch (POD X3 Live) will toggle between controlling Tone 1 and Tone 2. When you're on the one you want, you can select blocks, turn them on/off, tweak, and turn knobs as described earlier.

Tone 1 name is inverted if Tone 1 is selected. Tone 2 name is inverted if Tone 2 is selected:

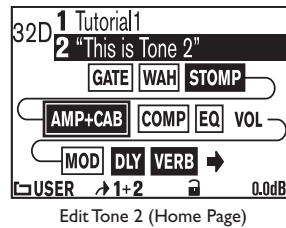
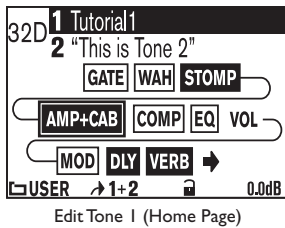

From a block's Edit Page, you can also press the **Tone 2** button (POD X3 & POD X3 Pro) or step on the **Tone 2** footswitch (POD X3 Live) to toggle between that block for each Tone.

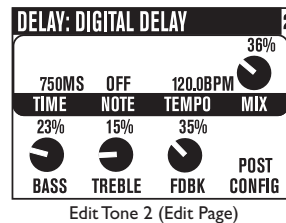
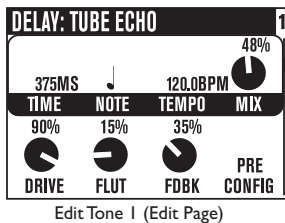

Note: You can also use an optional FBV or FBV Shortboard to control Dual Tone functions, as referenced in Steps 2 and 3 above. For details on setting this up, see Page 6•6.

Tone Volume Controls

- The **Tone Volume** knob adjusts the volume of the Tone that is currently selected. Use this control to set the correct balance between Tone 1 and Tone 2.
- From the Home Page, the rightmost **Multi-function** knob lets you adjust the volume of Tone 1 + Tone 2. Back off on this control if you're seeing the **Clip** light turn on. This level is saved and recalled with each preset.



Tone Volume adjusts the volume of the currently selected Tone.

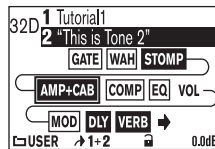

Multifunction Knob 4 adjusts the volume of both Tones at once.

You probably want all of your favorite sounds as loud as possible, while also having the right difference in volume between your lead and rhythm sounds, clean and dirty sounds, etc. Right? OK, then, to get this happy balance, start with your favorite 'clean' sounds.

Turn up their volume as high as you can without getting the **Clip** indicator to light when you strum hard, and save them that way. Then switch amongst them to see if some are too loud, and turn them down a bit to match well with the others.

Next, move on to select your 'dirtier' crunch and lead tones, comparing them to the clean sounds and saving them with lower volume settings to match well with those clean sounds.

Now, each time you use your POD X3, POD X3 Live or POD X3 Pro, you just have to set a **Master Volume** level you like, and you can switch amongst your various sounds without unhappy volume differences.

Preset Folders

POD X3, POD X3 Live and POD X3 Pro include over 350 presets to cover a wide range of styles. These presets store complete amp-and-effect selections and settings that you can call up at the touch of a button. Of these presets, there are 128 User locations that you can use to store your own custom tones.

The following folders of presets are available:

- USER: any presets you save go here (128 total)
- LOGAIN: for electric guitar (30)
- HIGAIN: for electric guitar (30)
- FX HVY: for electric guitar (20)
- SONGS: for electric guitar (40)
- ACOU: for acoustic guitar (15)
- VOCAL: for vocals (15)
- BASS: for bass guitar (40)
- BLENDS: Dual Tone Blends for electric guitar (30)
- DUAL: Dual Tone Pairs for independent inputs (30)

It's important to remember that since POD X3, POD X3 Live and POD X3 Pro have Dual Tone functionality, each preset actually stores settings for both Tone 1 and Tone 2. In fact, separate names for Tone 1 and Tone 2 are stored in each preset. This comes in very handy when recalling presets.

Recalling Presets

There are a couple of ways to recall presets from the Preset Library. To recall a “complete” preset (both Tone 1 and Tone 2) at once, do the following:

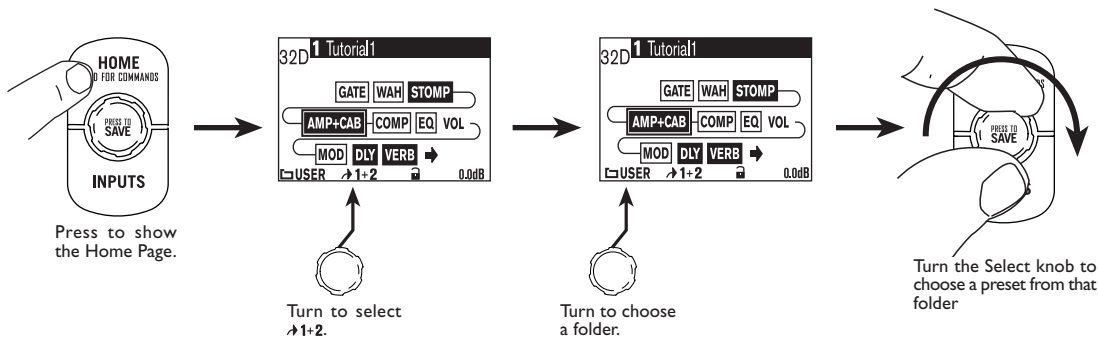

You can also choose to recall only Tone 1:

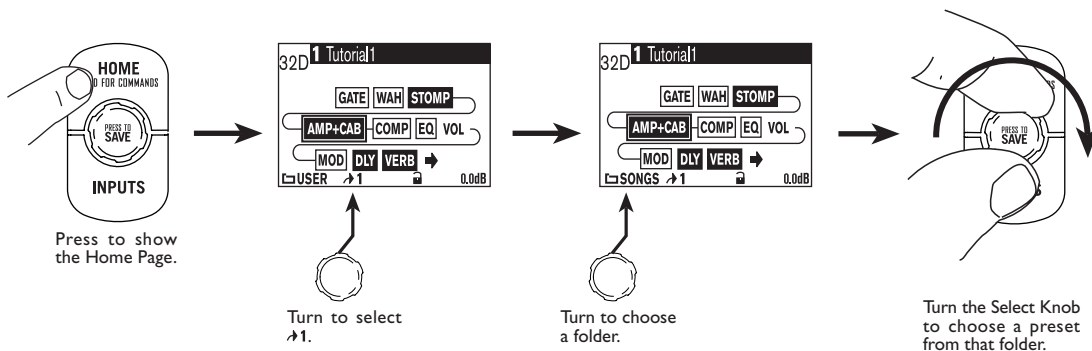

Or only Tone 2:

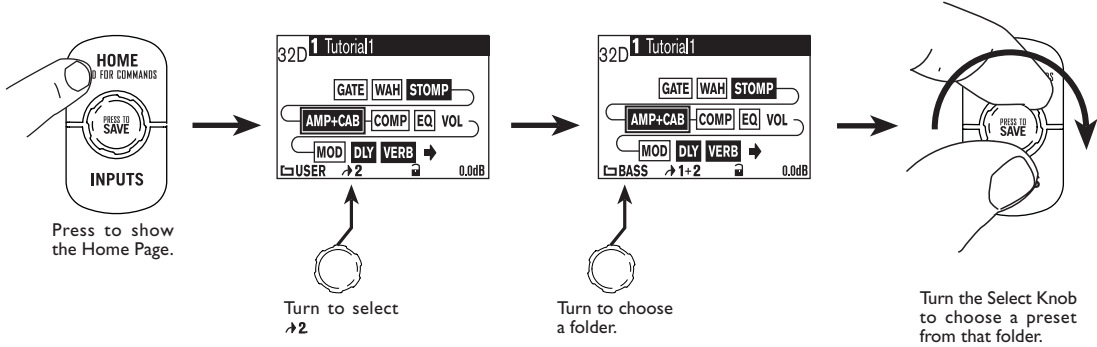

Note: You can also recall User Presets on POD X3 and POD X3 Pro using an optional Line 6 FBV, FBV Shortboard or FBV Express.

Recalling User Presets on POD X3 Live

Using POD X3 Live's footswitches, you can recall the 128 User presets with your feet. It's easy. Just step on the **Bank Up** or **Bank Down** footswitch to get to the bank you want (1-32), then use the **A**, **B**, **C**, or **D** footswitch to recall a preset from that bank (A-D). The preset will load as soon as you step on **A**, **B**, **C**, or **D**.

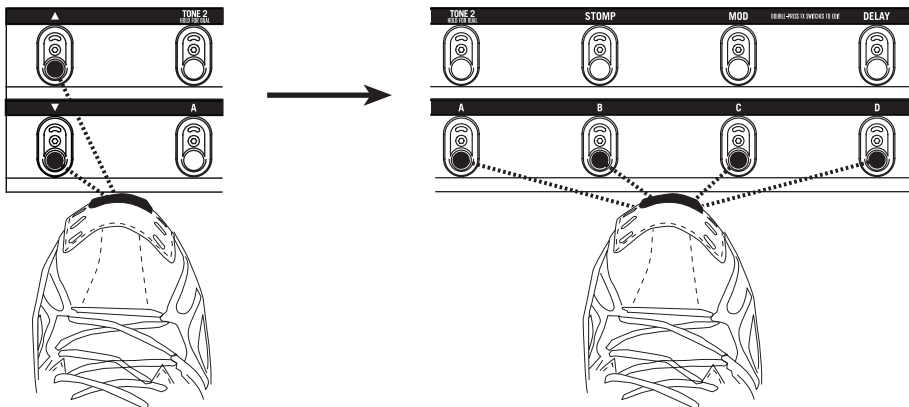

Locking Tone 2

From the Home Page, you can lock Tone 2 to prevent it from getting overwritten when loading new presets. This is handy when you're using Tone 2 for vocals and you want to make sure it doesn't change when you recall guitar presets on Tone 1.

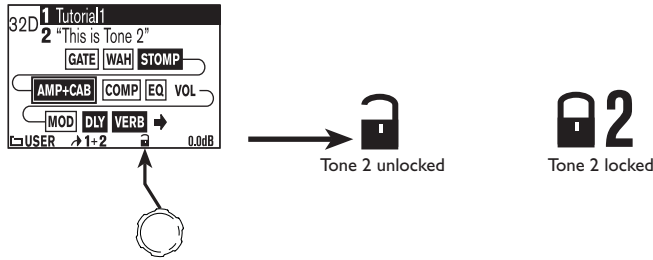

Saving Tones

You can edit any of the POD X3, POD X3 Live or POD X3 Pro's presets or create one of your own and store it to one of the 128 User preset locations.

To save a preset, follow these steps:

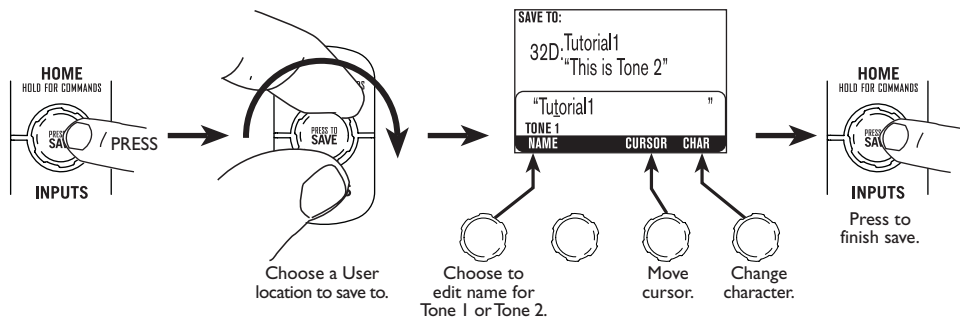

Tuner

Press and hold the **Tap** button or footswitch for 2 seconds to enter tuner mode — shazam! Instant digital chromatic tuner for Tone 1. The display will change to the following:

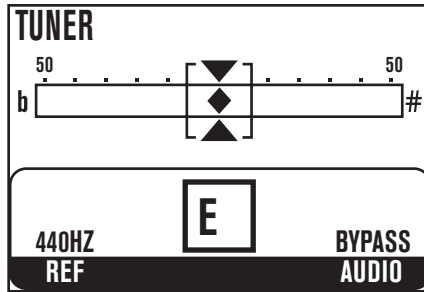

All Amp Model and effects processing are bypassed so you can hear those questionably-tuned strings clearly, should you choose to do so.

Play a note on your guitar and you'll see what note it is on that handy display; all half-step notes are displayed as flats, so you'll see $A\flat$ instead of $G\sharp$, for example. Play that string you're trying to tune again, turn its tuning key so the note goes sharp and then flat, and the little diamond will move to the right when it's sharp and back down to the left when it's flat. When you've got it tuned just right, the little diamond will sit right in the middle.

Ref – Want a different reference than $A=440\text{Hz}$? Turn the “Ref” knob to set the reference frequency anywhere from 425-455 Hz. This setting is stored so you don't have to reset it every time you turn on your POD X3, POD X3 Live or POD X3 Pro.

Audio – Normally, the audio will be muted while you're tuning, but if you prefer to hear yourself tune, turn the **Audio** knob to toggle between Mute and Bypass.

Press the **Tap** button or footswitch and the tuner disappears just as swiftly as it came.

REFERENCE: TWEAKING TONES

Amp + Cab

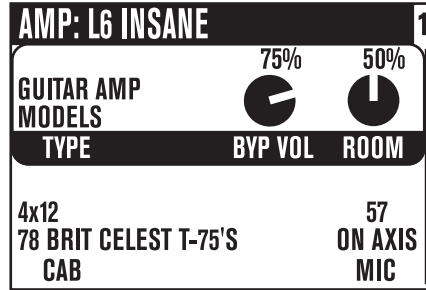

Type – turn this knob to select Guitar Amp Models, Bass Amp Models or Pre-Amp type Models.

Select Knob – once the Type has been selected, turn the Select Knob to pick an Amp Model. The Model names will appear at the top of the display.

Cab – spins through the available Cabinet Models. The available cabs will change depending on the Amp Model that is chosen.

Mic – changes the microphone selection.

Room - adjusts the amount of “room tone” in your sound. Low settings give you the sound of moving the virtual microphone closer to the virtual cabinet (you’ll hear only a small amount of the early reflections caused by the sound echoing in the room). Higher settings increase the early reflections, as if you moved the mic farther from the cabinet.

Byb Vol - sets the Bypass Volume, the volume that this tone will be set to when the Amp+Cab block is off. It doesn’t affect the volume you hear with the Amp+Cab block on.

Tone Controls

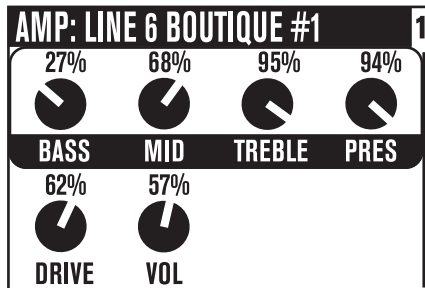

5•2

Tone Controls adjust the overall tone of the currently-loaded Amp Model. You should know that these controls are individually crafted for each Amp Model, so their response and interactivity will change depending on the Amp Model that is selected. For Guitar and Bass Amp Models, these correspond to the dedicated **Tone Control** knobs on the front panel of your POD X3, POD X3 Live or POD X3 Pro.

Momentary Display: When any of the physical Tone Control knobs are adjusted on the front panel, this edit page will be displayed, allowing you to see your settings as you tweak the controls. After 2 seconds of inactivity, the display will return to its previous state.

Guitar Amp Model Tone Controls:

Bass – bass tone control.

Mid – mid tone control.

Treble – treble tone control.

Pres – presence control, which brightens your tone.

Drive – controls how hard you’re driving the input of the chosen Amp Model, and just like the input volume control on a non-master volume guitar amp, higher settings give you more “dirt”.

Vol – controls the relative volume level of the current Tone; you can use this to balance levels between various tones, but in general, you should set this as high as possible for the best signal-to-noise ratio.

Bass Amp Model Tone Controls:

Bass – bass tone control.

Lo Mid – low-mid tone control.

Hi Mid – high-mid tone control.

Treble – treble tone control.

Drive – controls how hard you’re driving the input of the chosen Amp Model, and just like the input volume control on a non-master volume guitar amp, higher settings give you more “dirt”.

Vol – controls the relative volume level of the current Tone; you can use this to balance levels between various tones, but in general, you should set this as high as possible for the best signal-to-noise ratio.

Pre-Amp Model Tone Controls

Bass & Freq – bass tone control; level and frequency.

Lo Mid & Freq – low-mid tone control; level and frequency.

LMid – turn to choose 1x or 10x the low-mid frequency.

Hi Mid & Freq – High-mid tone control; level and frequency.

HMid – turn to choose 1x or 10x the high-mid frequency.

Hi Pass – high-pass filter frequency.

Lo Gn & Fq – low-frequency shelving tone control; level and frequency.

Lm Gn & Fq – low-mid peaking tone control; level and frequency.

Mid Gn & Fq – mid peaking tone control; level and frequency.

Hm Gn & Fq – high-mid peaking tone control; level and frequency.

Hi Gn & Fq – high-frequency shelving control; level and frequency.

Stomp Boxes

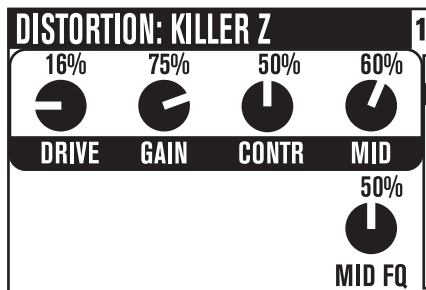

5•4

What guitarist doesn't like Stompboxes? POD X3, POD X3 Live and POD X3 Pro include an arsenal of amazing-sounding Distortion, Dynamics, and Filter Stomp Box Models, lovingly crafted after a whole carpet-full of the greatest effects of guitar history. Quick descriptions for the various parameters that appear for different Models are listed below.

Select Knob – turn to pick a Stomp Box model.

Distortion Stomp Boxes

Drive/Gain – amount of distortion/overdrive/grind/gain.

Tone – overall effect tone control.

Contr – on Killer Z, adjusts the contour of the tone.

Mid – mid tone control.

Treble – treble tone control.

Bass – bass tone control.

Blend – on the Bronze Master, adjusts the blend of tonal elements.

Mid Fq – selects middle frequency for tone adjustment.

Dynamics Stomp Boxes

Sust – varies the compression threshold.

Level – adjusts the overall level.

Sens – varies the effect’s response to your playing.

Amount – on Vetta Juice, varies the ratio of compression.

Ramp – for Swell effects, sets the time it takes for your sound to “ramp” from quiet to loud.

Depth – for Swell effects, sets how much the volume of your attacks is reduced.

Frequency – on De-Essers, chooses the frequency that’s targeted for reduction.

Amount – on De-Essers, the amount of reduction applied to Frequency.

5•5

Filter Stomp Boxes

Sens – varies the filter’s response to **your** playing.

Q – adjusts the filter’s width.

Decay – sets how fast (or slow) the effect trails off.

Wave – allows you to choose from among the effect’s available waveforms.

Mix – controls the ratio of wet (effected) to dry (non-effected) sound that is heard.

-1 Oct – controls how loud you want the “one octave down” waveform.

-2 Oct – controls how loud you want the “two octaves down” waveform.

Filter – sets the corner frequency of the filter’s low-pass filter; frequencies above this frequency are cut.

INTVLI – chooses the first pitch interval of your original note played.

INTVL2 – chooses the second pitch interval of your original note played.

Reference: Tweaking Tones

Attack – controls how long it takes for the effect to happen.

Pos – represents the current angle of that pedal, with 0% meaning the pedal is fully heel down, and 100% meaning it's fully toe down. If you don't have a pedal connected, you can still adjust **Pos** to get a “parked wah” sound.

Heel – sets how much effect you'll hear when the pedal is at its minimum (heel down) setting. Set it to 0% to have no effect in the heel down position.

Toe – sets how much effect you'll hear when the pedal is at its maximum (toe down) setting.

Modulation Effects

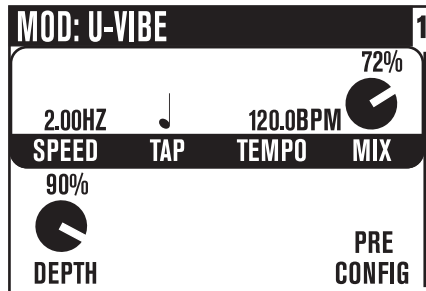

Modulation effects are things that swoosh, pulse and warble—from phase shifters to flangers to choruses. Why are they called modulation effects? Well, if we consult a dictionary, we discover that ‘modulate’ in the electronic world means to “alter the amplitude or frequency of (a wave) by (using) a wave of a lower frequency to carry a signal” (definition courtesy of The Oxford Encyclopedic English Dictionary, Third Edition, thank you very much). That modulating wave is what causes all that swooshing, pulsing, and warbling.

5•7

Select Knob – turn to load a Modulation effect Model.

Speed – directly controls how fast (or slow) the modulating waveform sweeps.

Tap – set this to OFF to have this effect ignore tempo, or pick a note value that you’d like your speed to match; works with the **Tap** button/footswitch and the **Tempo** knob.

Tempo – Shows the tempo that’s been set by **Tap**, and lets you fine tune it.

Mix – controls the ratio of wet (effected) to dry (non-effected) sound that is heard.

Depth – controls the overall amplitude of the modulating wave, which usually determines just how intense the effect will be.

Bass – bass tone control.

Treble – treble tone control.

Config – allows you to choose the position of the Mod pedal in your signal flow: **Pre**

Reference: Tweaking Tones

(before the amp model), or **Post** (after the amp model).

Fdbk – adjusts how much of the effected signal is fed back to the input of the effect.

Manual – on Jet Flanger, controls the length of the very short delay that's applied to the sweep to make the flanging effect happen.

Wave – adjusts shape of the waves that drive the Tremolos and Auto Pan.

Tone – overall tone control.

Predly – adjusts how long it takes for the effect to kick in.

Q – adjusts tone focus from sharp to broad.

Freq – changes the frequency that the effect is focused on.

Flut – adjusts the amount of tape-style flutter for Tape Eater.

Dist – distortion, baby!

Delay

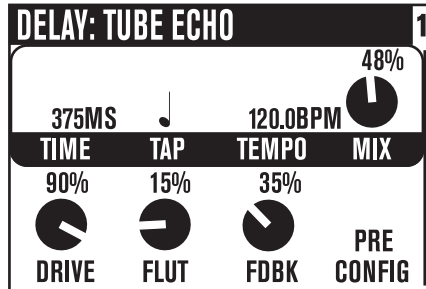

Select Knob – turn to pick a Delay model.

Time – for mono delays, sets the time for the delay line; for stereo delays, sets the time for the left side delay line.

Tap – set this to OFF to have this effect ignore tempo, or pick a note value that you'd like your speed to match; works with the **Tap** button/footswitch and the **Tempo** knob.

Tempo – Shows the tempo that's been set by **Tap**, and lets you fine tune it.

Mix – controls the ratio of wet (effected) to dry (non-effected) sound that is heard.

Bass – bass tone control.

Treble – treble tone control.

Fdbk – adjusts how much of the delayed signal is fed back to the input of the delay.

Config – allows you to choose the position of the Delay pedal in your signal flow: **Pre** (before the amp model), or **Post** (after the amp model).

ModSpd – for delays with modulation, controls how fast (or slow) the modulating waveform sweeps.

Depth – for delays with modulation, controls the overall amplitude of the modulating wave.

Drive – for Tape Delay models, adds some tube warmth.

Flut – for Tape Delay models, adjusts wow-and-flutter, that unique sound of a slipping, dirty capstan.

Heads – for some Tape Delays, enables you to choose from the available combinations of the model's virtual tape heads.

Speed – is the speed of the modulation for a modulated Delay Model.

L-Fdbk – for Stereo Delays, controls the left-channel feedback.

R-Fdbk – for Stereo Delays, controls the right-channel feedback.

Offset – for Stereo Delays, sets the time for the right side delay line, as a percentage of the left delay's Time setting.

Spread – for Stereo Delays, sets the stereo spread of the delays from mono to hard-panned left and right.

Tone – overall tone control.

Bits – for Low Rez Delay, lets you adjust the delay anywhere from 12 bit resolution down to as few as 4 truly nasty bits. Bear in mind that as you turn the knob clockwise, you're reducing the bit resolution, so maximum bit reduction is achieved when the knob is all the way up (think of it as a more control for how many less bits you want). Your direct sound, of course, stays full resolution.

Reverb

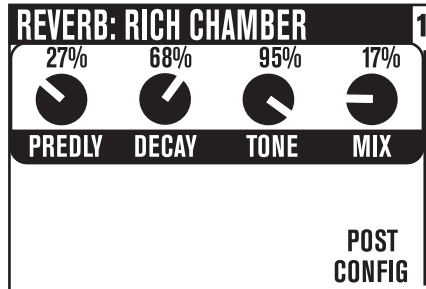

When we set out to create POD X3, POD X3 Live and POD X3 Pro, we devoted our fanatical modeling technology and energy for innovation to developing no-compromise reverb effects. The collection of reverb models emulate physical environments (rooms and halls), plate reverbs (which traditionally feature a big steel plate with some sort of speaker driving it, and usually multiple pickups to pick up the vibrations of the plate), spring reverbs (the kind guitar players know best), and even a couple of unique new models that you'll have to hear to appreciate.

Select Knob – turn to pick a Reverb model.

Dwell – for Spring reverbs, determines how hard the virtual springs are driven; the harder you drive them, the longer the delay time.

Tone – overall tone control.

Mix – controls the ratio of wet (effected) to dry (non-effected) sound that is heard.

Predly – adjusts how long it takes for the reverb to kick in.

Decay – adjusts how long it takes for the reverb to trail off.

Config – allows you to choose the position of the Reverb in your signal flow: **Pre** (before the Amp Model), or **Post** (after the Amp Model).

Momentary Display: When you adjust the physical Reverb knob on the front panel, this edit page will be displayed, allowing you to see all your Reverb settings as you tweak the Mix level. After 2 seconds of inactivity, the display will return to its previous state.

Gate

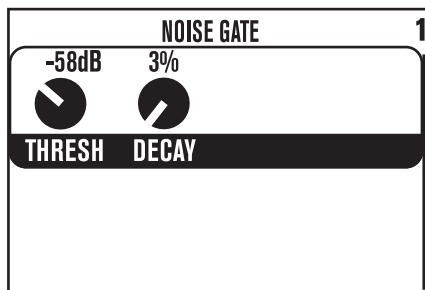

The Gate effect helps eliminate unwanted noise when you're not playing, and can be especially valuable when using high gain sounds. Like a security gate, it's supposed to quickly open to pass the things that you want, and then swing closed to keep out the things that you don't want.

Thresh – determines how loud your playing has to be to open the gate. More negative numbers (where the knob is near its fully-counterclockwise setting) mean that the gate will open and allow sound through even when you are playing quietly, and less negative numbers (where the knob is near its fully-clockwise setting) mean that the gate will only allow sound to pass when you are playing pretty hard. Turn the **Thresh** all the way down to minimum to disable the Gate (**Thresh**'s value will then be "Off").

Decay – determines how fast the gate will swing closed. Like a gate in the real world, a fast decay means the gate might catch your trailing foot as you pass through – in this case, that means the gate will chop off the decay of your notes. And a slow decay means that as the gate swings slowly closed behind you, someone might have time to slip through – in this case, that would be the unwanted noise that you hear as your notes decay. You'll have to experiment with the **Decay** to get just the right happy medium for your particular guitar, playing style, and sound settings.

Compressor

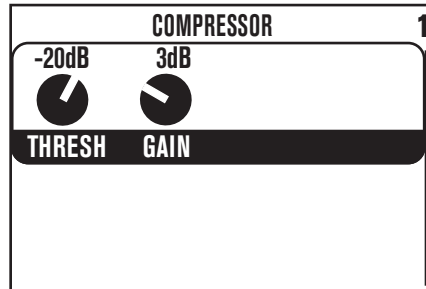

The Compressor effect is just the thing when you want to smooth out your levels the way that you would typically do in a recording studio.

Thresh – determines how aggressive you want the Compressor to be in smoothing things out. More negative numbers make the Compressor more active in taming your levels, so -32dB is a more aggressive setting than -16dB, say. Some makeup gain is also added as you turn the knob to the left, making for a much easier tweaking experience.

Gain – controls (what else?) gain, so that even when you're really squashing your signal with an aggressive threshold setting, you'll be able to get good volume levels out of your POD X3, POD X3 Live or POD X3 Pro.

EQ

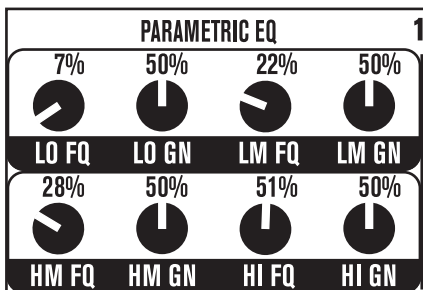

Here's some good, old-fashioned EQ to make your tone sparkle, rattle the neighbor's windows, and everything in-between. You've got (2) bands of shelving EQ and (2) bands of semi-parametric "peaking" EQ to choose from.

5•14

Lo Fq – sets the corner frequency of the low-shelf filter, affecting all sound at and below the frequency you select.

Lo Gn – adjusts the gain or cut amount of the low-shelf filter.

Lm Fq – sets the corner frequency of the low-mid peaking filter, affecting all sound at and around the frequency you select.

Lm Gn – adjusts the gain or cut of the low-mid peaking filter.

Hm Fq – sets the corner frequency of the high-mid peaking filter, affecting all sound at and around the frequency you select.

Hm Gn – adjusts the gain or cut of the high-mid peaking filter.

Hi Fq – sets the corner frequency of the high shelf filter, affecting all sound at and above the frequency you select.

Hi Gn – adjusts the gain or cut of the high-shelf filter.

Wah

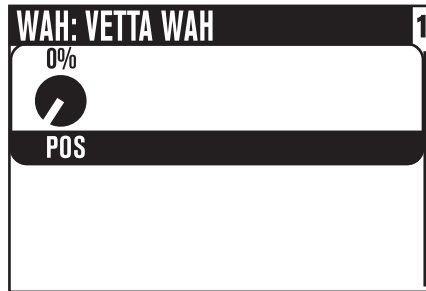

The **Wah** effect is generally expected to be controlled by the pedal built into POD X3 Live or an optional Line 6 FBV foot controller or third-party MIDI controller.

Select Knob – turn to pick a Wah pedal. Your choices are Vetta Wah, Fassel, Weeper, Chrome, Chrome Custom, Throaty, Conductor and Colorful.

Pos – represents the current angle of that pedal, with 0% meaning the pedal is fully heel down, and 100% meaning it's fully toe down. If you don't have a pedal connected, you can still adjust **Pos** to get a “parked wah” sound.

Volume Pedal

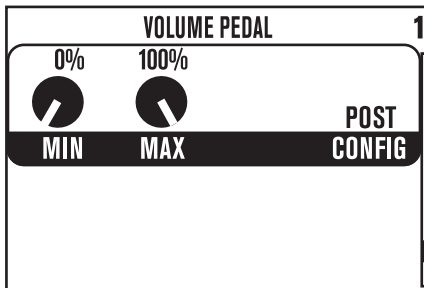

The **Volume** effect is generally expected to be controlled by the pedal built into POD X3 Live or an optional Line 6 FBV foot controller or third-party MIDI controller.

5•16

Min – determines how much volume you’ll hear when the volume pedal is at its minimum (heel down) setting. Set it to 0% to have silence in the heel down position.

Max – determines how much volume you’ll hear when the volume pedal is at its maximum (toe down) setting.

Config – allows you to choose the position of the volume pedal in your signal flow: **Pre** (before the amp model), or **Post** (after the amp model).

Effects Loop (POD X3 Live & POD X3 Pro only)

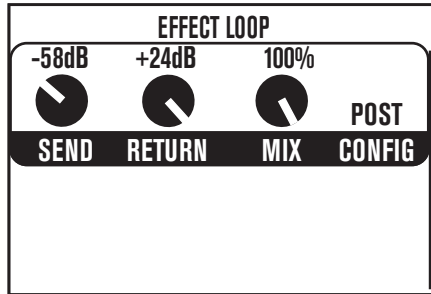

This lets you tweak the settings related to the Effects Loop. Note that the Loop can only be on for one Tone at a time, and turning the Loop on for one Tone automatically forces it off for the other.

Send – adjusts the gain of the send output from -80 to 0 dB.

Return – adjusts the gain of the return inputs from 0 to +24 dB.

Mix – 0-100%: set this to 100% for parallel-style operation.

Config – allows you to place the Effect Loop in two different locations in the POD X3 Live and POD X3 Pro's signal chain:

- **Pre** – after the Stomp block, before the Mod and Delay blocks.
- **Post** – before the Mod, Delay and Reverb blocks.

If nothing is connected to the loop, POD X3 Live and POD X3 Pro are smart enough to disable the loop so you still get sound.

REFERENCE: CONFIGURATION & SETUP

Inputs

Press the **Inputs** button to get to the Inputs page:

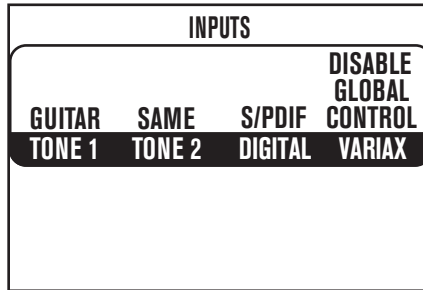

Here, you can route your hardware inputs to Tone 1 and Tone 2.

Tone 1 – pick an input to get routed to Tone 1.

- For POD X3, you can choose Guitar or Microphone.
- For POD X3 Live, you can also choose Aux, Variax, Guitar + Aux, Guitar + Variax, or Guitar + Variax + Aux.
- For POD X3 Pro, your choices are Gtr 1, Mic 1, Line 1, Variax, Gtr 1+Gtr 2, Gtr 1+Variax, Gtr 1+Gtr 2+Variax, Gtr 2, Line 2, Mic 2, Guitar Stereo, Mic Stereo, Line Stereo, Digital Left, Digital Right and Digital Stereo.

Tone 2 – pick an input to get routed to Tone 2.

- For POD X3, you can choose Same as Tone 1, Guitar, or Microphone.
- For POD X3 Live, you can also choose Aux, Variax, Guitar + Aux, Guitar + Variax, or Guitar + Variax + Aux.
- For POD X3 Pro, your choices include all of the Tone 1 input assignment choices listed above, plus Same as Tone 1. Your Tone 2 input choices are restricted, however, depending on the input you've selected for Tone 1. For example, when a Stereo setting is selected for Tone 1 input, Tone 2 will automatically be set to Locked For Stereo. In this mode, no other input selection will be available for Tone 2.

Reference: Configuration & Setup

- **Analog Input Restriction:** POD X3 Pro does not allow simultaneous input from more than one analog input per Channel Strip. For example, if Gtr 1 is selected as input for Tone 1, no combination of a Tone 1 analog input such as Gtr 1, Mic 1, Line 1, Gtr 1+Gtr 2, Gtr 1+Variax or Gtr 1+Gtr 2+Variax will be available for Tone 2.

Digital (POD X3 Pro only) – select either S/PDIF or AES/EBU for digital input.

- **Digital Input Restriction:** Only one digital input can be active at once. For example, if Variax is selected as an input, AES/EBU and S/PDIF will not be available.

Variax (POD X3 Live and POD X3 Pro only) – you have two choices here:

- Enable Global Control – the X3 Live or Pro will control your Variax, and the lower half of the LCD will display its currently selected Model and other parameters.
- Disable Global Control – when global control is disabled, your Variax will be heard but it won't respond to patch changes. The lower half of the LCD will be blank.

Outputs

Pressing the **Outputs** button gets you to the first of two Outputs pages:

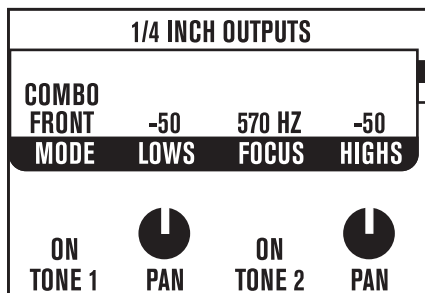

Press the 4-way Nav **Left** and **Right** to move between page 1 and page 2.

Outputs Page 1: 1/4-inch Outputs – this is where you set up the 1/4-inch outputs on POD X3, POD X3 Live and POD X3 Pro.

Mode – turn this knob to pick from:

“**Studio**” **Modes** (for direct connections to a mixer, recorder, PA, or headphones)

- Match Studio/Direct – the 1/4-inch jacks output the Studio/Direct Mode mix set on

the second Outputs page.

- Studio/Direct Tone 1 – the 1/4-inch jacks output Tone 1 only, panned center, with Studio Mode processing.
- Studio/Direct Tone 2 – the 1/4-inch jacks output Tone 2 only, panned center, with Studio Mode processing.

“Live” Modes (for feeding a guitar amp, without speaker/mic/room simulation, and with a set of controls for On/Mute and Pan for Tone 1 and Tone 2 that is independent from the Studio/Direct Mix settings)

- Combo Front – use this to jack into the instrument input of a combo guitar amp.
- Combo Pwramp – use this to jack into the power amp input of a combo guitar amp.
- Stack Front – use this to jack into the instrument input of a guitar amp head with separate cab.
- Stck PwrAmp – use this to jack into the power amp input of a guitar amp head with separate cab.

Lows – when Combo Front or Stack Front are chosen for **Mode**, this control appears to let you lower the overall bass output of POD X3, POD X3 Live or POD X3 Pro. This helps to counteract any bass boost you may have built into your guitar amp.

Focus – when Combo Front or Stack Front are chosen for **Mode**, this control appears to let you increase the overall midrange output of POD X3, POD X3 Live or POD X3 Pro. This helps to counteract any mid cut that may be built into your guitar amp.

Highs – when Combo Front or Stack Front are chosen for **Mode**, this control appears to let you lower the overall treble output of POD X3, POD X3 Live or POD X3 Pro.

Tone 1 – allows you to either turn On or Mute Tone 1, independent of the settings of the Studio/Direct Mix that drive the XLR and other outputs.

Pan – sets the location of Tone 1 in the stereo field, independent of the settings of the Studio/Direct Mix that drive the XLR and other outputs.

Tone 2 – allows you to turn On or Mute Tone 2, independent of the settings of the Studio/Direct Mix that drive the XLR and other outputs.

Pan – sets the location of Tone 2 in the stereo field, independent of the settings of the Studio/Direct Mix that drive the XLR and other outputs.

Outputs Page 2: Studio/Direct Mix

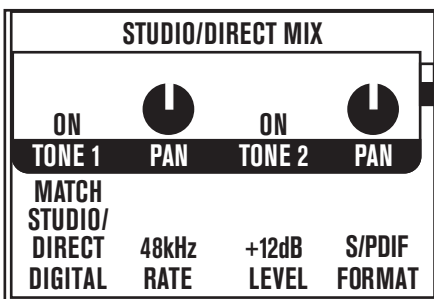

- This mix provides POD's legendary direct recording sound, ideal for connecting direct to a mixer, recorder, PA, or headphones for "Studio Mode" sound.
- The headphone and USB 1-2 outputs always get this mix.
- For POD X3 Live and POD X3 Pro, this also always feeds the XLR Direct Outs.
- The 1/4-inch outputs can get this mix, too, when desired. (See next page.)

Tone 1 – allows you to either turn On or Mute Tone 1.

Pan – sets the location of Tone 1 in the stereo field.

Tone 2 – allows you to turn On or Mute Tone 2.

Pan – sets the location of Tone 2 in the stereo field.

Digital – sets the signal for the digital output. There are four options:

- Match Studio/Direct – Digital outputs the Tone and Pan settings as shown.
- Studio/Direct Tone 1 – Digital outputs Tone 1 only, panned center.
- Studio/Direct Tone 2 – Digital outputs Tone 2 only, panned center.
- Dry Inputs – Digital Left outputs the unprocessed input(s) to Tone 1, and Digital Right outputs the unprocessed input(s) to Tone 2.

Rate – affects the digital output only, setting the S/PDIF or AES/EBU signal's sample rate to 44.1, 48, 88.2, 96 kHz or Match Digital In.

Level – affects the digital output only, adding up to 12 dB of gain. This can be useful

to increase the digital output level of sounds that don't have a lot of Amp Model or stompbox distortion or other settings that are driving their levels up.

Format – selects the digital output's format, either S/PDIF or AES/EBU for POD X3 Pro, S/PDIF for POD X3 and POD X3 Live.

System

Press and hold the **Outputs / Hold for System** button for 2 seconds to get to the System page:

SYSTEM			
CNTRL	TONE:1	TONE:2	SETS
BOTH	1-W/V	1-W/V	ALL
TONES	(2-VOL)	(2-VOL)	OUTS
PEDAL	PEDAL	PEDAL	MSTVOL
TONE:1	TONE:2	TONE1:	TONE2:
DELAY	DELAY	COMP	COMP
MIX	MIX		
TWK	TWK	LP SW	LP SW

Press the 4-way Nav **Up** and **Down** to move between this and page 2.

System Page 1: Pedal and other settings

The Pedal-related settings here are for the wah/volume/tweak pedal built-in to POD X3 Live, and the pedal on some FBV foot controllers that can be used with POD X3 and POD X3 Pro.

Pedal – use this to have the pedal affect either Tone 1, Tone 2 or Both.

Pedal Tone:1 & Pedal Tone:2 – The built-in pedal on a POD X3 Live and some FBV foot controllers is pedal “1” and the optional external pedal you can connect to it is pedal “2”. Here you can select what those pedals control, with these choices:

- 1-W/off 2-Vol – Pedal 1 controls Wah with the toe switch controlling Wah on/off. Pedal 2, if present, controls Volume.
- 1-Twk 2-Vol – Pedal 1 controls whatever is assigned to Tweak in the lower half of the LCD display. Pedal 2, if present, controls Volume.

- **1-Wah/Vol 2-Tweak** – Pedal 1 controls Wah and Volume with the toe switch toggling between the two. Pedal 2, if present, controls whatever is assigned to Tweak.

Mstvol (POD X3 Live & POD X3 Pro only) – choose whether the Master Volume knob will control 1/4-Live Outputs only, XLR Direct Outputs only, or both (All Outputs). When playing on stage with a POD X3 Live, you may find it valuable to have the Master Volume affect your 1/4-inch outs only, so you can tweak on-stage levels as needed without altering the levels that you’re sending to the house sound system.

Twk – if you’ve assigned a pedal to control **Tweak**, this is where you pick the setting that you want to control. The list of available settings is too long to list here—turn the knob and see what you find!

Compsw (POD X3 Live only) – pick which processing block will be controlled by the **Comp (Boost)** footswitch. Your choices are COMP, AMP, LOOP or VERB.

Loopsw (POD X3 & POD X3 Pro only) – pick which function will be controlled by the **FX Loop** footswitch of the optional FBV or FBV Shortboard foot controller. In addition to COMP, AMP or VERB, you can choose DUAL, which will perform the same toggling between Tone 1 and Tone 2 as the **TONE 2 (Hold For Dual)** button, including the **Hold For Dual** function to enable/disable Dual Tone via footswitch.

System Page 2: Pedal and other settings

From the first System page, pressing down on the 4-way Nav takes you to page 2 where the firmware version and USB version of your unit are displayed, along with:

Contrst – set the contrast of the POD X3, POD X3 Live & POD X3 Pro’s display.

MIDI Ch (POD X3 Live & POD X3 Pro only) – choose from MIDI Channel 1-16, or select Omni to have POD X3 Live & Pro respond to all MIDI channels, while transmitting on Channel 1. The MIDI channel chosen from the display user interface will be used as the Channel for Tone 1. Tone 2 will use the next MIDI Channel.

When program change messages 0-127 are received, POD X3 Live & Pro will recall User Presets 01A-32D, and will transmit those same program changes as presets are selected from the POD X3 Live & Pro hardware. It also echoes all program change messages it receives, so it can be connected “thru” to another MIDI device.

Visit www.line6.com/manuals for more comprehensive MIDI CC information.

Commands

Press and hold the **Home / Hold for Commands** button for 2 seconds to get to the Commands page:

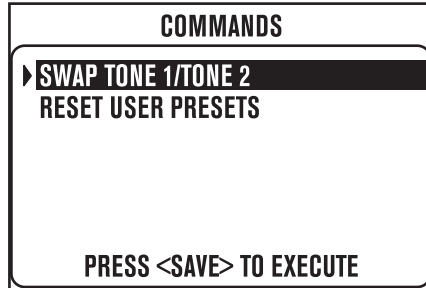

Turn the **Select** knob to choose a Command, then press the **Save** button to execute the Command. Press the **Home** button to exit without executing a command.

6•7

Swap Tone 1 / Tone 2 – just like the name says, your current Tone 1 and Tone 2 settings will be swapped.

Reset User Presets – this command will reset all 128 User presets to their factory-standard settings. **WARNING: this will destroy any customized settings you may have saved.**

EXAMPLE SETUPS

Need quick instructions for a particular setup? Just follow these easy steps. And like any good recipe, once you've got the hang of things, feel free to add your own tweaks on these recommended settings to spice it up...

Mono or Stereo Recording or Direct to Mixer/PA

1. Connect output(s) to your recorder, mixer or PA:
 - **POD X3:** connect the 1/4-inch outs.
 - **POD X3 Live & POD X3 Pro:** the XLR outputs are recommended for live sound systems, to provide a level that approximately matches a mic'ed up amp. You can also use them for recording into mic preamps, or use the 1/4-inch outputs to get hotter, line level outputs.
2. Set the second OUTPUTS page (Studio/Direct Mix):
 - Tone 1: as desired
 - Tone 1 Pan: as desired
 - Tone 2: as desired
 - Tone 2 Pan: as desired
3. When using the 1/4-inch jacks, also set the 1/4-inch OUTPUTS page:
 - Mode: MATCH STUDIO/DIRECT
4. Check your Master Volume.
 - Select the loudest preset/settings you intend to use.
 - Play your instrument and turn Master Volume as high as you can without clipping the system you're feeding.

Recording Tone 1 & 2 to Separate Mono Tracks

1. Connect outputs to your recorder:
 - **POD X3:** connect the 1/4-inch outs.
 - **POD X3 Live & POD X3 Pro:** the XLR outputs are recommended for live sound systems, to provide a level that approximately matches a mic'ed up amp. You can also use them for recording into mic preamps, or use the 1/4-inch outputs to get hotter, line level outputs.
2. Set the second OUTPUTS page (Studio/Direct Mix):
 - Tone 1: On
 - Tone 1 Pan: pan left
 - Tone 2: On
 - Tone 2 Pan: pan right
3. When using the 1/4-inch jacks, also set the first OUTPUTS page (1/4-inch):
 - Mode: MATCH STUDIO/DIRECT
4. In your recording system, assign those outputs to separate recording tracks.

7•2

Recording Tone 1 & 2 to Separate Stereo Tracks (POD X3 Live & POD X3 Pro only)

1. Connect the 1/4-inch left/right outputs to your recorder as the source for the first track, and the XLR left/right outputs as the source for the second track.
2. Set the second OUTPUTS page (Studio/Direct Mixer):
 - Mode: Studio/Direct
 - Tone 1: Off
 - Tone 2: On (the XLRs will output Tone 2 only)
 - Tone 2 Pan: Center

3. Set the first OUTPUTS page (1/4-inch jacks Outputs):
 - Mode: Studio/Direct Tone 1

Feed One Guitar Amp

1. Connect 1/4-inch output(s) to your amp or speaker system.
2. Set the first OUTPUTS page (1/4-inch Outputs):
 - Mode: Combo Front, Combo Pwramp, Stack Front, or Stack PwrAmp.
 - Lows, Focus, Highs: as desired
 - Tone 1: On
 - Tone 1 Pan: Center
 - Tone 2: On
 - Tone 2 Pan: Center
3. Check your Master Volume.
 - Select the loudest preset/settings you intend to use.
 - Play your instrument and turn Master Volume as high as you can without clipping the amp/speakers you're feeding.

Feed Two Guitar Amps, One for Tone 1 and One for Tone 2

1. Connect the left 1/4-inch output to one amp, and the right 1/4-inch output to the other.
2. Set the first OUTPUTS page (1/4-inch Outputs):
 - Mode: Combo Front, Combo Pwramp, Stack Front, or Stck PwrAmp.
 - Lows, Focus, Highs: as desired
 - Tone 1: On

Example Setups

- Tone 1 Pan: Full Left
 - Tone 2: On
 - Tone 2 Pan: Full Right
3. Check your Master Volume.
 - Select the loudest preset/settings you intend to use.
 - Play your instrument and turn Master Volume as high as you can without clipping the amp/speakers you're feeding.

Feed Two Guitar Amps, One “Wet” and One “Dry”

1. Connect the left 1/4-inch output to one amp, and the right 1/4-inch output to the other.
2. Set the first OUTPUTS page, (1/4-inch Outputs):
 - Mode: Combo Front, Combo Pwramp, Stack Front, or Stck PwrAmp.
 - Lows, Focus, Highs: as desired
 - Tone 1: On
 - Tone 1 Pan: Full Left
 - Tone 2: On
 - Tone 2 Pan: Full Right
3. Check your Master Volume.
 - Select the loudest preset/settings you intend to use for your “dry” sound.
 - Play your instrument and turn Master Volume as high as you can without clipping the amp/speakers that you're using as your dry amp.
4. Set up your “dry” tone.
 - Dial in your dry sound on Tone 1, with little or no “wet” effects,
 - Save your preset.
5. Set up your “wet” tone.

- From the Home Page, turn the second knob below the display, and begin loading Tone 2 settings.
 - Selecting Tone 1 from the preset you just saved (you've copied Tone 1 to Tone 2).
 - Set Tone 2's Tone Volume low.
 - Add more effects to Tone 2, cranking up the effect mixes, so you hear all or nearly all "wet" signal from Tone 2.
6. Save your preset, using WET in the name of Tone 2, so you'll remember what it's for.

Feed a Guitar Amp and Send Separate XLR Direct Outs (POD X3 Live & POD X3 Pro only)

1. Connect 1/4-inch output(s) to your amp or speaker system.
2. Connect XLR output(s) to your recorder, mixer or PA.
3. On the first OUTPUTS page (1/4-inch Outputs):
 - Mode: Combo Front, Combo Pwramp, Stack Front, or Stck PwrAmp.
 - Lows, Focus, Highs: as desired
 - Tone 1: On
 - Tone 1 Pan: as desired
 - Tone 2: On
4. On second OUTPUTS page (Studio/Direct Mix) set the XLR output signals:
 - Mode: Studio/Direct
 - Tone 1: On
 - Tone 1 Pan: as desired
 - Tone 2: On
 - Tone 2 Pan: as desired
 - Tone 2 Pan: as desired
5. Check your Master Volume.

Example Setups

- Select the loudest preset/settings you intend to use.
- Play your instrument and turn Master Volume as high as you can without clipping the amp/speakers you're feeding.

Electric Guitar to On-Stage Amp and Direct Out + Vocals/Acoustic/etc. to Direct Out Only

1. Connect your electric guitar to Guitar In.
2. Connect your microphone to the Mic In, or your acoustic, etc. to the Aux or Line In.
3. On the INPUTS page:
 - Tone 1: Guitar
 - Tone 2: select the (inputs) you're using for your Mic, acoustic, etc.
4. Connect 1/4-inch output(s) to your amp or speaker system.
5. Connect XLR output(s) to your recorder, mixer or PA.
6. On first OUTPUTS page (1/4-inch outputs):
 - Mode: Combo Front, Combo Pwramp, Stack Front, or Stck PwrAmp.
 - Lows, Focus, Highs: as desired
 - Tone 1: On
 - Tone 1 Pan: center
 - Tone 2: Mute (so your vocal/acoustic/etc. doesn't go to your on-stage amp)
7. On second OUTPUTS page (Studio/Direct Mix):
 - Mode: Studio/Direct
 - Tone 1: On
 - Tone 1 Pan: Left
 - Tone 2: On
 - Tone 2 Pan: Right

8. Check your Master Volume.

- Select the loudest preset/settings you intend to use.
- Play your instrument and turn Master Volume as high as you can without clipping the amp/speakers you're feeding.

USB & COMPUTER SOFTWARE

Updating POD X3, POD X3 Live or POD X3 Pro's Firmware

Here are step-by-step instructions for making sure your POD X3, POD X3 Live or POD X3 Pro has the latest firmware installed.

1. From **www.line6.com/monkey**, download and install the latest version of Line 6 Monkey.
2. Run Monkey.
 - If this is the first time you run Monkey, you don't yet have driver software installed, so Monkey won't be able to communicate with your POD X3, POD X3 Live or POD X3 Pro. (And if you have an older version of Monkey, it also may not show your POD X3, POD X3 Live or POD X3 Pro in its list of products when it asks you to select your product manually.)
 - If POD X3, POD X3 Live or POD X3 Pro is not shown as a product selection, **select any TonePort** from the product select menu that Monkey will show as it starts up.
 - Once Monkey finishes start up, login with the user name and password that you use for line6.com, or click the New User button near the top of Monkey's window, create a user name and password for line6.com, and then use it to log in to Monkey.
3. On the Updates tab, look to see if Line 6 Monkey itself is up to date.
 - Monkey is listed under Applications on the Updates tab. A green circle with a checkmark is shown next to its listing if it's up to date. If not, highlight its line in the list of Items, and click the Update button on the right. (Of course, this shouldn't be necessary if you just downloaded the latest!)
4. Once Monkey's up to date, install the latest Line 6 drivers.
 - In the Updates tab, highlight the Driver item, and click the Update button on the right. Monkey will lead you through the process, which requires you to quit Monkey and possibly restart your machine.
5. Once the driver installation completes, run Monkey again.
 - Make sure your POD X3, POD X3 Live or POD X3 Pro is powered on, and connected to your computer via USB. Monkey should automatically recognize your POD X3,

POD X3 Live or POD X3 Pro and complete its startup.

6. On the Updates tab, look to see if your USB Firmware and Flash Memory are up to date.
 - If either one doesn't show a green circle with a checkmark, highlight Device Firmware and click the Update button to the right. Monkey will lead you through the process.
7. With your Driver and Device Firmware now up to date, you're ready to rock.

Setting Up For USB Recording

1. After getting the latest versions and installing your driver as described above...
2. Start your recording application.
3. Follow its instructions to select POD X3, POD X3 Live or POD X3 Pro as your audio device.
4. On Windows, you'll probably want to configure POD X3, POD X3 Live or POD X3 Pro for ASIO operation.
 - For Windows, the POD X3, POD X3 Live and POD X3 Pro driver control panel is at Programs > Line 6 > Tools > Line 6 Audio-MIDI Devices.
 - For Mac, it's available from the Apple menu, System Preferences > Other > Line 6 Audio-MIDI Devices.
5. With ASIO on Windows, or Core Audio on Mac, POD X3, POD X3 Live and POD X3 Pro provide 8 audio inputs to your computer:
 - 1-2 is the main signal, configured on POD X3, POD X3 Live or POD X3 Pro's Outputs page for Digital/XLR Outs.
 - 3-4 is Tone 1 separately in stereo.
 - 5-6 is Tone 2 separately in stereo.
 - 7 is the sum of the inputs you've chosen for Tone 1.
 - 8 is the sum of the inputs you've chosen for Tone 2.

5. The 7 and 8 inputs are perfect as raw sources for plug-in processing.
 - See www.line6.com/gearbox_plugin for info on our POD X3-equivalent plug-in.
6. Connect your headphones or powered speakers directly to your POD X3, POD X3 Live or POD X3 Pro to hear your computer-generated audio, as well as the POD X3, POD X3 Live or POD X3 Pro's real-time processing.
 - The Monitor level adjustment slider in the control panel lets you turn down the volume of POD X3, POD X3 Live or POD X3 Pro versus your computer-generated sound.
 - The Master Volume knob on POD X3, POD X3 Live or POD X3 Pro does NOT affect the USB, S/PDIF or AES/EBU output levels.
 - Sample rate and other settings can be made from your recording program, the Line 6 Audio-MIDI Devices control panel, the Windows control panels, and/or Mac OS X's Applications > Utilities > Audio-MIDI Setup. (The Rate and Level parameters on the first Outputs page of POD X3 and POD X3 Live apply to the S/PDIF output only. On the POD X3 Pro they apply to S/PDIF or AES/EBU output only.)

USB Sends When Operating In Stereo Tone Mode

When operating in Stereo Tone mode, the USB Sends of your POD X3, POD X3 Live or POD X3 Pro will provide the following 8 outputs to your computer:

- 1 is the Stereo Tone with balance and mute Left.
- 2 is the Stereo Tone with balance and mute Right.
- 3 is the Stereo Tone without balance or mute Left.
- 4 is the Stereo Tone without balance or mute Right.
- 5 is the Stereo Tone without balance or mute Left.
- 6 is the Stereo Tone without balance or mute Right.
- 7 is the Stereo Input Left dry.
- 8 is the Stereo Input Right dry.

APPENDIX A: SIGNAL FLOW

POD X3

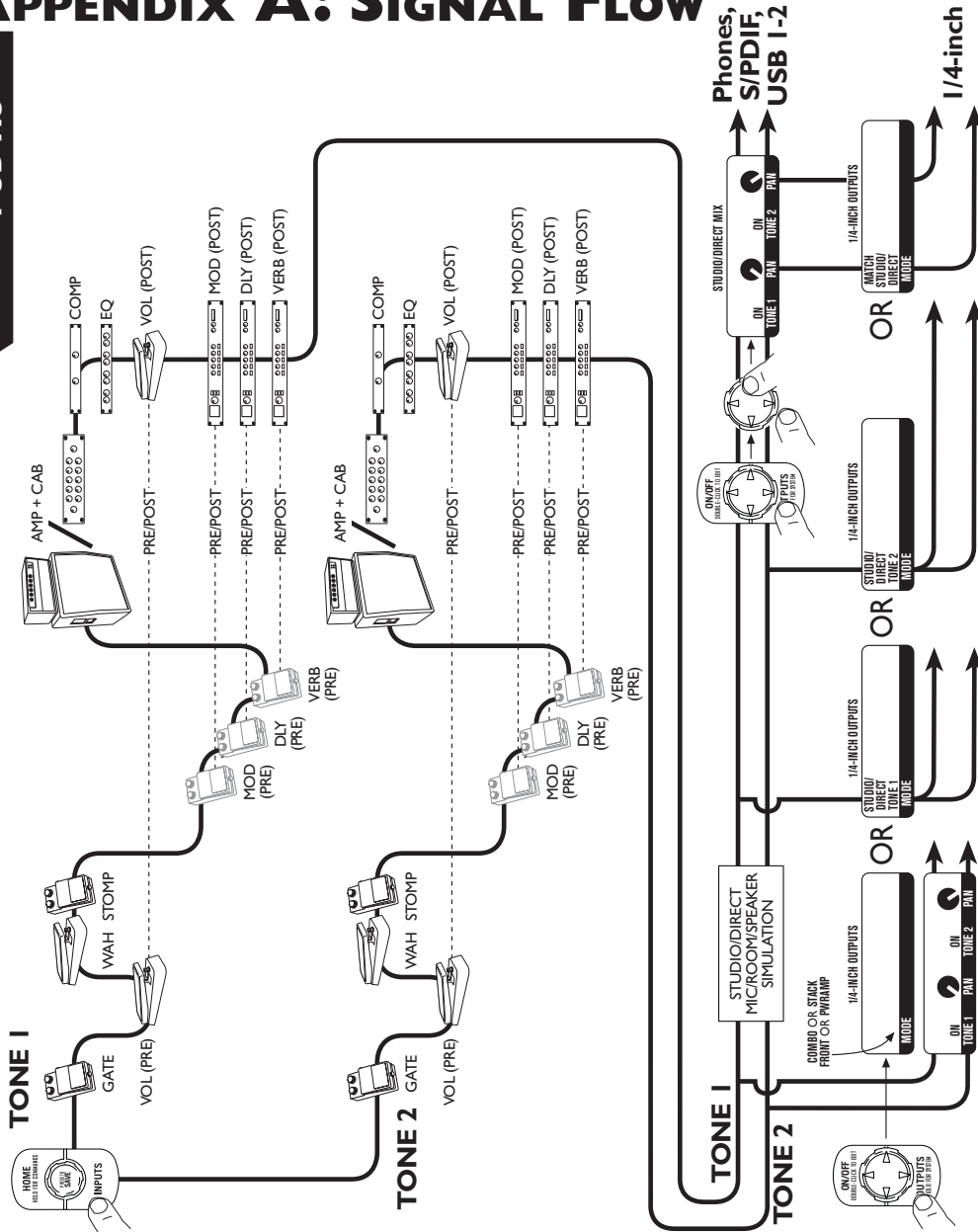

POD X3 Live

A-2

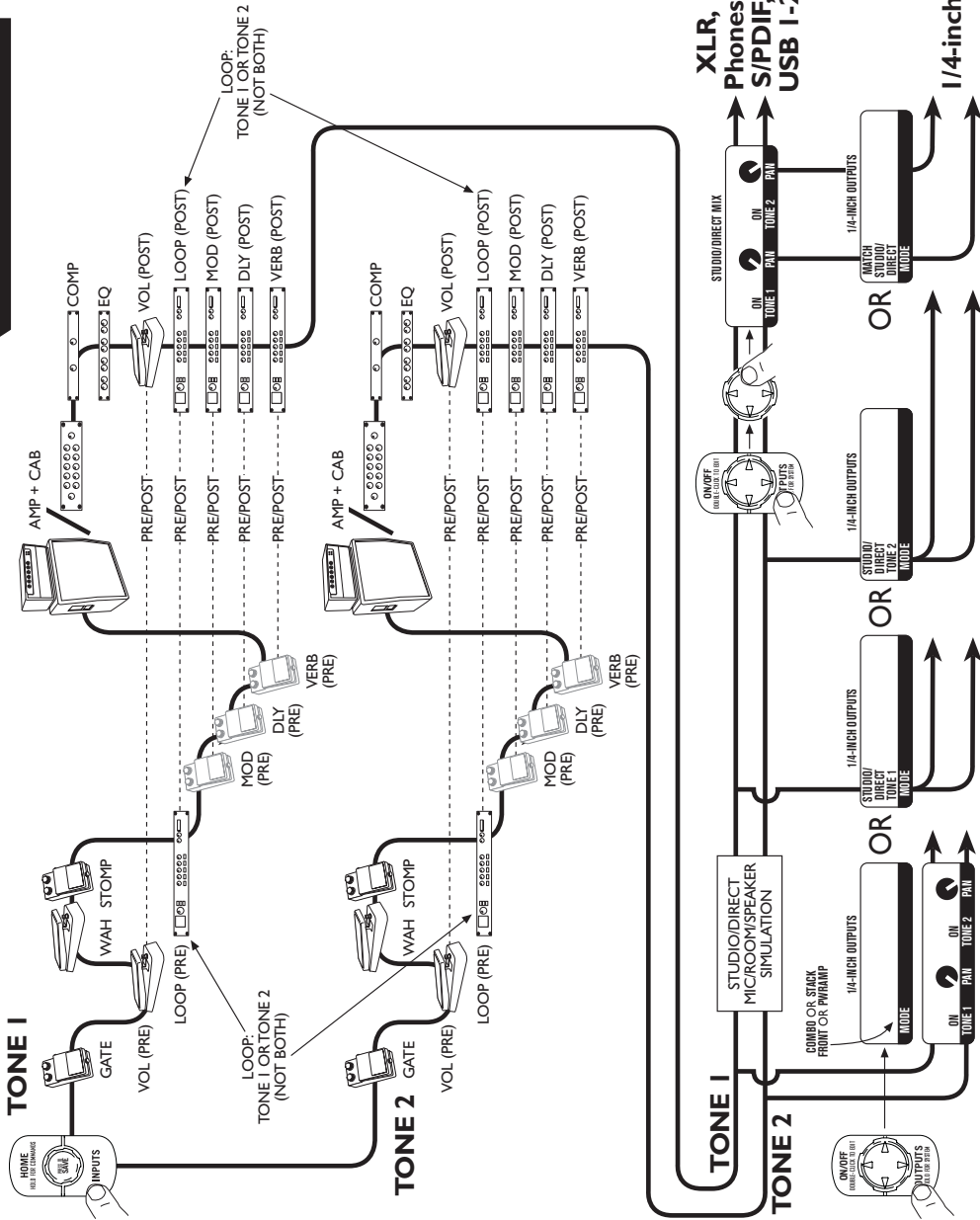

POD X3 Pro

