



**QLIGHT™ SERIES
TQ-440SP**

USER MANUAL

**Turbosound Ltd.
Star Road, Partridge Green
West Sussex RH13 8RY England
Tel: +44 (0)1403 711447 Fax: +44 (0)1403 710155
web: www.turbosound.com**

Issue 1.0 Copyright © 2000 Turbosound Ltd.

08/06/2001 3:35 PMCONTENTS

Safety Information	3
Thanks	4
Unpacking	4
Introduction	5
Features	5
Product Summary	6
Connector Panel Functions	7
System Requirements	8
AC Power Requirements	8
Power Amplifiers	8
Audio Input	9
Limiting Functions	9
Music / Speech Optimisation	9
Equalisation	10
Dispersion	10
Cooling	10
Mounting and fixing	11
Arraying	15
Choosing the best location	16
Maintenance	17
Appendix A: Technical Specifications	19
Appendix B: Spares and Accessories	20
Appendix C: Warranty	21



An example of this equipment has been tested and found to comply with the following European and international Standards for Electromagnetic Compatibility and Electrical Safety:

Radiated Emissions (EU): EN55013-1 (1996)

RF Immunity (EU): EN55103-2 (1996) RF Immunity, ESD, Burst Transient, Surge, Dips & Dwells

Electrical Safety (EU): EN60065 (1998)

Electrical Safety (USA): UL6500 3rd edition (1997)



Samples of this product have been tested and were found to comply with UL's safety requirements.

Important Safety Information

Do not remove Covers. There are no user serviceable parts inside, please refer servicing to qualified service personnel. This equipment must be earthed.



CAUTION
RISK OF ELECTRIC SHOCK
DO NOT OPEN
DO NOT EXPOSE TO RAIN OR MOISTURE



ATTENTION
RISQUE DE CHOC ELECTRIQUE
NE PAS ENLEVER
NE PAS EXPOSER A LA PLUIE NI A L'HUMITE



Important Safety Information

Please read carefully and keep the following instructions and safety information. Heed all warnings and follow all instructions.

- Do not remove covers. There are no user serviceable parts inside, please refer servicing to qualified service personnel. This equipment must be earthed.
- Do not block any of the ventilation openings. Install in accordance with manufacturer's instructions.
- Clean only with a damp cloth.
- Do not defeat the safety purpose of the polarized or grounding-type plug. A polarized plug has two blades with one wider than the other. A grounding type plug has two blades and a third grounding prong. The wide blade or the third prong is provided for your safety. When the provided plug does not fit into your outlet, consult an electrician for replacement of the obsolete outlet.
- Protect the power cord from being walked on or pinched particularly at plugs, convenience receptacles, and the point where they exit from the apparatus.
- Only use attachments/accessories specified by the manufacturer.
- Use only with a cart, stand, tripod, bracket or table specified by the manufacturer, or sold with the apparatus. When a cart is used, use caution when moving the cart/apparatus combination to avoid injury from tip-over.
- Refer all servicing to qualified service personnel. Servicing is required when the apparatus has been damaged in any way, such as the power supply cord or plug is damaged, liquid has been spilled or objects have fallen into the apparatus, the apparatus has been exposed to rain or moisture, does not operate normally, or has been dropped.

Thanks

Thank you for choosing a TURBOSOUND TQ-440SP self-powered loudspeaker product for your application. Please spare a little time to digest the contents of this manual, so that you can obtain the best possible performance from this unit.

All TURBOSOUND products are carefully engineered for world class performance and reliability.

If you would like further information about this or any other TURBOSOUND product, please contact us. Detailed product information is available on our web site at www.turbosound.com.

We look forward to helping you in the near future.

Unpacking the TQ-440SP loudspeaker

After unpacking the unit please check carefully for damage. If damage is found, please notify the carrier concerned at once. You, the consignee, must instigate any claim. Please retain all packaging in case of future re-shipment.

Introduction

Congratulations, you have just purchased a professional loudspeaker system from the renowned Turbosound range, designed to give you the best in audio quality and many years of reliable, trouble free operation. It offers superior audio quality, unsurpassed vocal projection, full technical documentation including EASE data, and comprehensive rigging and flying hardware options. Please read through this manual carefully before you attempt to operate the loudspeaker system. It contains valuable information enabling you to quickly and easily set up and connect the loudspeakers, important system and set-up checks together with positioning and mounting instructions.

Features

- ◆ **Superb audio quality:** carefully designed and matched loudspeaker drive units are used throughout to give you exceptional performance and many years of reliable, trouble free operation.
- ◆ **Controlled dispersion:** the TQ-440SP enclosure exhibits a tight, controlled dispersion pattern which minimises room reflections and focuses the sound pressure directed at audience areas.
- ◆ **Ease of use:** the TQ-440SP is easy to set up and use with the minimum of technical knowledge required. The built-in power amplifiers require only mains a power connection and signal input for correct operation.
- ◆ **Three way design:** the exclusive use of cone transducers in the low and mid frequency bands guarantees a seamless low/mid crossover, greater power handling, lower distortion and minimal mechanical stress.
- ◆ **Speech / Music optimisation:** user-selectable frequency response profiles are provided to suit specific applications.
- ◆ **Time aligned components:** the mid frequency and high frequency drive units are physically time-aligned within the enclosure to ensure perfect time arrival.
- ◆ **Solid construction:** all Turbosound QLight series cabinets are built from high grade birch plywood, rebated, screwed and glued together for maximum rigidity and durability.
- ◆ **Integral rigging points:** fitted as standard, enabling use with many different types of optional flying hardware.
- ◆ **Compact enclosure:** custom designed 12"/1" co-axial driver allows this three-way enclosure to be the equivalent size of many traditional two-way designs.

Product Summary

The TQ-440SP is a compact three-way self-powered full range enclosure including integral power amplifiers and control electronics. The use of active power amplifier technology ensures an exact match between amplifier and speaker for optimum acoustic output, and offers exceptional ease of use by combining the entire electro-acoustic system in one convenient, easily transportable physical package.

It incorporates a custom-designed co-axial 12"/1" combination LF/HF driver in an optimally tuned vented trapezoidal enclosure handling the low and high frequency bands. The critical mid-range frequencies are handled by a proprietary 6.5" cone transducer on a 60° horizontal by 40° vertical nominal dispersion waveguide, loaded with a TurboMid™ device.

The exclusive use of cone transducers in both the low and mid frequency bands produces a seamless transition at the crossover frequency, with the result that all of the critical vocal range right up to 8kHz is lower in distortion than compression driver-based designs. In addition the 6.5" mid-range driver is a highly efficient device, and is able to handle large amounts of amplifier power. The remaining high frequencies above 8kHz are effortlessly handled by a 1" compression driver, operating in a relatively narrow pass band, and therefore subjected to minimal mechanical stress. The mid and high components are physically time aligned within the enclosure, ensuring perfect time arrival at the listener's ear. When compared to conventional two-way designs the TQ-440SP is able to offer higher SPL, significantly lower distortion, and unsurpassed vocal projection capabilities in an equivalently sized physical package.

A rear panel switch selects optimised profiles for speech or music applications, enabling real flexibility of use.

The TQ-440SP is a full range loudspeaker, and used by itself will provide high quality audio for all speech and many music reproduction applications. In order to extend the effective bass frequency range of the loudspeaker by a further octave the use of the complementary TQ-425SP subwoofer is recommended.

Connector Panel Functions

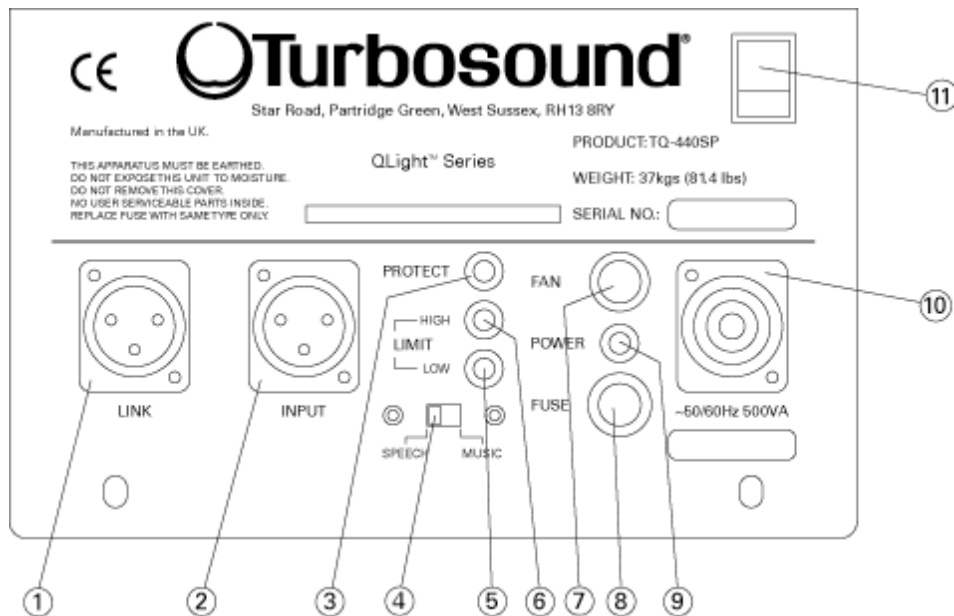

1. **Signal link** – lockable 3-pin XLR line output socket links to additional cabinets. Fully balanced, pin 2 Hot, pin 3 Cold and pin 1 not connected.
2. **Signal input** – locking 3-pin XLR line input socket connects to audio mixer. Fully balanced, pin 2 Hot, pin 3 Cold and pin 1 screen (shield).
3. **Protect** – Red LED indicates that the amplifier module is in protect mode.
4. **Speech / Music switch** – selects between optimised frequency response profiles.
5. **Limit (low)** – orange LED indicates limiting threshold of the low frequency section.
6. **Limit (high)** – yellow LED indicates limiting threshold of the mid/high frequency section.
7. **Fan** – 24 volt DC supply for the connection of an external cooling fan.
8. **Fuse** – AC line fuse. Replace only with same type.
9. **Power** - Blue LED indicates when AC power is applied to the amplifier module.
10. **AC mains connection** - accepts Speakon Powercon 3-pin cable-end connector.
11. **Mains switch** – turns AC power on to the unit.

System Requirements

The TQ-440SP is a self-powered loudspeaker system. It comprises two independent amplifier channels: one channel to power the low frequency driver (LF) plus another channel to power the midrange (MF) and high frequency (HF) together; and a frequency dividing network to split the signal and feed it to the appropriate driver section. Additional features such as accurate and optimised peak limiters for both high and low frequency sections are incorporated into the control electronics. The TQ-440SP does not require the use of external amplifiers or crossover/limiters.

Additional TQ-440SP units may be daisy-chained together simply by linking the signal connections through the input / link XLR connectors. In this way exact coverage of an event or permanent installation may be achieved using a number of self-powered loudspeakers. It is however necessary to route individual power cords to each enclosure as it is not possible to daisy chain through the power connectors.

AC power requirements

The TQ-440SP is equipped with a Neutrik Powercon AC mains connector, which mates with the power cord supplied with your unit. The TQ-440SP operates with mains voltages either in the range from 100 to 120 volts a.c. or from 220 to 240 volts a.c. The mains voltage on your unit will have been preset at the factory prior to shipment. However for clarification please check that both the product and the power cord match the mains supply available in your area before use.

Should it be necessary to alter the mains voltage setting, for example when touring a country with mains voltage supply differing from that of the country of original shipment, the mains voltage switch is located on the inside of the amplifier module adjacent to the mains transformer. Follow the instructions given in the Maintenance section of this manual for removal of the amplifier module, and change the voltage setting to match the available supply.

The mains fuse is a 3.15A 20mm anti-surge type for 230v mains supplies, and 6.3A 20mm anti-surge type for 115v mains supplies. Should it ever be necessary, always replace the fuse with the identical size and type.

Power Amplifiers

The TQ-440SP is equipped with two high power amplifiers designed with sufficient headroom to handle large signal transients without break up or distortion, in contrast to other self-powered designs which attempt to compromise using inadequately powered amplifiers. The LF amplifier delivers 250 watts r.m.s., while the MF/HF amplifier delivers 150 watts r.m.s.

Audio Input

The signal input to the TQ-440SP is fully balanced, with an input impedance of 10kΩ. The input XLR connector is wired pin 2 hot (+ve), pin 3 cold (-ve), and pin 1 screen (shield). The link XLR connector is wired pin 2 hot (+ve), pin 3 cold (-ve), and pin 1 not connected. Multiple TQ-440SP enclosures may be driven from a single audio console, up to a practical limit of 16 units. Any more will cause unacceptable signal loss due to the loading of the console output.

Limiting Functions

The TQ-440SP is equipped with accurate peak limiters for both high frequency and low frequency sections. Because the HF and LF limiters work independently of each other, there is no possibility of either section compromising the performance of the other as is the case with a single broad-band limiter. Furthermore, each limiter has its attack and release time constants independently set and optimised according to the operating frequency range.

Music / Speech Optimisation

A rear panel switch modifies the overall response of the TQ-440SP in order to give you optimised profiles for different applications. When the speech position is selected, the response of the system will exhibit a reduced low frequency / low midrange content, which has the effect of making the upper part of the frequency range more prominent. This results in exceptionally good intelligibility, and therefore the speech setting is recommended whenever maximum voice projection is required. Additionally, under most circumstances the speech setting will provide higher perceived maximum sound pressure level.

When the music position is selected, the low frequency section is extended down to a nominal cut-off frequency of 55Hz, which makes the TQ-440SP balanced for full range reproduction of a wide range of music. The low frequency extension is achieved by using a combination of a 2nd order high-pass filter and a dynamic EQ section, with the following benefits:

- ◆ Frequencies below 50Hz are attenuated, and the mechanical stress on the low frequency drive unit is therefore maintained within safe limits.
- ◆ The use of dynamic as well as than fixed EQ reduces the loss of headroom on large signals.

Equalisation

Because the TQ-440SP features a smooth and even frequency response, it does not need equalisation or correction to overcome the deficiencies often found in lesser designs.

Should extended frequency response be required at more than medium sound pressure levels, the use of the complementary TQ-425SP self-powered subwoofer is strongly recommended

In order to compensate for the room acoustics, the TQ-440SP requires only minimal equalisation. As in any system, over-equalisation introduces phase shifts, distortion and a reduction in headroom, usually causing more problems than it cures.

Under most circumstances a 1/3 or 1/2 octave graphic equaliser will generally be adequate, with the fader settings applied smoothly and as little as possible for the required room compensation. Most rooms will have resonances that will be excited at particular frequencies needing some *cut* to help tame the sound, these problems are most pronounced at the lower frequencies where speakers generally exhibit very little directional control.

If you find that the system needs a lot of *boost* at lower frequencies you may need additional sub-bass units as stated above. It is good practice to use as little equalisation as possible, aiming to cut frequencies rather than adding large amounts of boost.

Dispersion

One of the design features of the TQ-440SP is its tightly controlled 60° horizontal by 40° vertical nominal dispersion pattern at mid and high frequencies. This gives many user advantages and eases placement decisions, being essentially a point and shoot system. A 60° horizontal polar pattern equals an angle of 30° either side of the centre line at which the sound pressure level is 6dB down with respect to centre, (averaged over the whole frequency range of the loudspeaker). Thus a 40° vertical dispersion gives an angle of 20° above and below the horizon.

Cooling

The TQ-440SP amplifiers are normally cooled by the action of convection from the large heatsink mounted externally to the amplifier module at the rear of the enclosure. It is important to leave sufficient space around and especially above the heatsink to allow the convection of heat away from the loudspeaker. Under the majority of circumstances this cooling effect is sufficient to maintain the amplifiers within a normal operating temperature range. In conditions of high ambient temperature and/or in very confined spaces, the use of an external fan module is recommended. A 24 volt socket is provided on the rear panel for that purpose.

Mounting and Fixing

A versatile range of mounting hardware is available for the TQ-440SP that allows it to be used in a variety of ways, in either mobile applications or permanent installations.

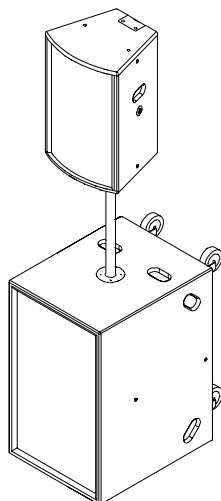

A top hat stand type fitting is mounted in the base of the cabinet for use with 35mm diameter loudspeaker stands with a load rating of at least 37kgs (82lbs).

This top hat fitting may also be used to mount the TQ-440SP cabinet at the correct height above the complementary TQ-425SP subwoofer using a straight 35mm pole.

Internal metric threaded rigging points are provided in several locations on the cabinet – on the top, bottom and sides - enabling it to be flown using standard M10 shoulder eyebolts (available from Turbosound). Downward inclination of the enclosure can be adjusted using an additional rigging point on the rear of the cabinet.

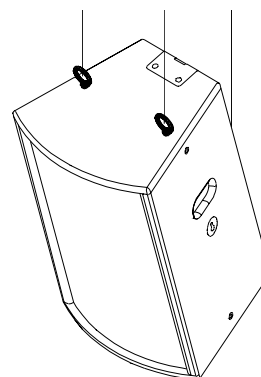

Side-mounted flying strips can be fitted to the sides of the enclosure by removing the countersunk bolts on the top and sides of the cabinet and replacing them with the M10 bolts provided with the hardware. Two FF-440 flying strips are required for each enclosure. This method offers a simple and cost effective method of flying single or multiple TQ-440SP enclosures, with the load being taken through the steel strips rather than through the woodwork of the enclosure. Enclosures may be arranged in a vertical column by coupling the flying strips together using QL-75 quicklinks or shackles.

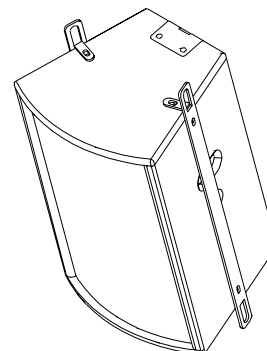

The universal FB-12 flybar assembly enables the use of several different fixing methods, shown in the diagram here. The flybar is attached to the cabinet using a pair of captive M10 shoulder eyebolts (supplied). There are 12 attachment points equally spaced along the length of the spine. Depending on which point is chosen for the given attachment system, a wide range of downward inclination can be achieved over a range of approximately 70 degrees. The design of the flybar even allows for upwards angles, for example for coverage of balconies that are higher than the loudspeaker

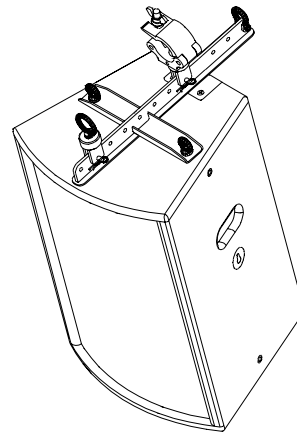

location.

The FB-12 flybar assembly comes supplied with a **U-6 Unilock** which provides a single attachment point. The point at which the Unilock is attached to the flybar determines the vertical angle of the

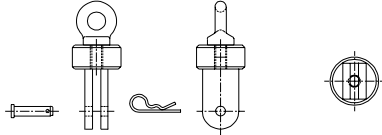

loudspeaker as shown in the table following.

.

A **PP-440 pick-up point adaptor** offers a further single attachment point. This option provides fast adjustment of vertical angle. The point at which the eyebolt adaptor is attached to the flybar determines the vertical angle of the loudspeaker as shown in the table following.

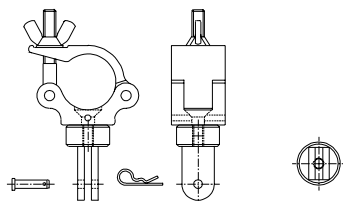

The SC-440 aluminium scaffold clamp adaptor is attached to the T-bar by means of a simple clevis coupler. It is designed to rotate horizontally through 360° in order to enable accurate

positioning of the loudspeaker. The point at which the scaffold clamp is attached to the flybar determines the vertical angle of the loudspeaker as shown in the table following.

The following table gives the predicted downward angle of the enclosure using the various attachment points on the FB-12 flybar assembly.

Attachment position	Vertical angle (negative angle denotes upwards)
Hole number 1 (front of cabinet)	-29°
Hole number 2	-23°
Hole number 3	-17°
Hole number 4	-10°
Hole number 5	-3°
Hole number 6	4°
Hole number 7	11°
Hole number 8	18°
Hole number 9	24°
Hole number 10	30°
Hole number 11	35°
Hole number 12 (rear of cabinet)	40°

The FH-440 is a complete flying frame and harness which enables the TQ-440SP to be installed with the maximum of security. It provides unlimited variation of horizontal and vertical inclination, and is very easy to re-position and angle once rigged.

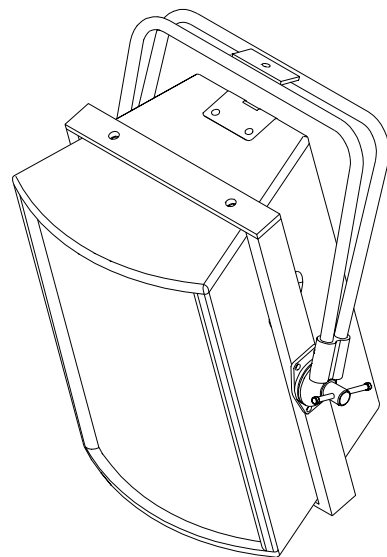

Modular flybar assembly The key element in flying multiple TQ-440SP enclosures is a versatile Flying Bar Assembly (FB-58), manufactured by Turbosound, that will support a vertical column of up to three enclosures deep. Fly bars can be linked in the horizontal plane using the index pins provided to form arched arrays with adjustable (horizontal) angles from 0° to 45° at 5° increments per cabinet. This allows arrays and clusters of almost any angle to be configured with the ability to change array angles without dismantling and whilst suspended. This useful feature allows for fine tuning of speaker positions for best coverage, throw and SPL's.

On each side of the TQ-440SP cabinet you will find keyhole type quick-release flying plates, plus top and bottom rear brackets for pull-up straps and linking plates. Single cabinets are suspended with short fixed length steel cables (FS-40) and pull up straps (TS-440) to align the downward angle. When flying more than one cabinet in the vertical plane the second row of speakers is flown on longer fixed length steel cables (FS-61).

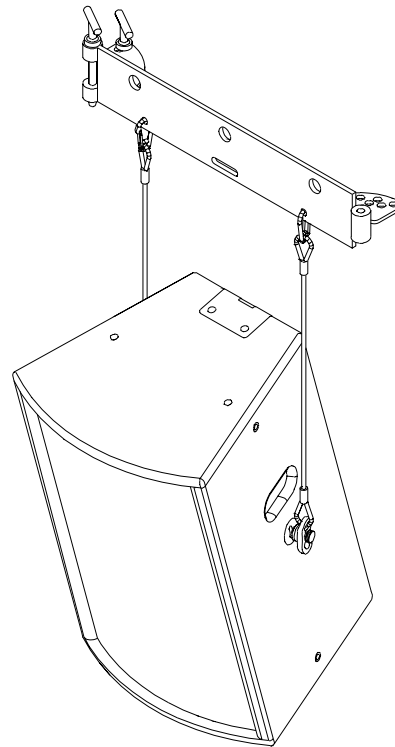

Any installation, whether temporary or permanent, must be securely attached to the structure of the building using chain, steel wires or web straps which are certified and load rated for the purpose. The combined weight of the sound system, its cables and the rigging system must be safely carried by the points at which attachment is made to the building or structure. Great care must be taken in selecting the attachment points and methods, being absolutely sure of the load carrying capacity of points chosen.

NOTE: The rigging of loudspeaker systems is an extremely serious matter with potentially lethal consequences should anything go wrong. It is of vital importance that you, or other people rigging the system, are suitably qualified to do so and have a full understanding of all the factors involved with safety as a number one priority. Turbosound accepts no responsibility for any accident, damage or failure of any rigged system. This rigging information is specifically related to the requirements of the TQ-440SP only. For more detailed information on the whole topic of rigging various handbooks are available. If you are in any doubt contact your Turbosound dealer who will be able to refer you to an experienced rigging company.

Arraying

The TQ-440SP has a side-wall angle of 16° . Use this position for smooth horizontal dispersion that is ideal for many applications. With the high dynamic range capability and low power compression of the TQ-440SP you should find this wide angle arrangement adequate for all but the most demanding long throw requirements. It also has the advantage of needing fewer cabinets to cover the required area.

When speakers are mounted together in close proximity either stacked on top of each other or arrayed the output increases due to the coupling effect. For instance, stacking two cabinets on top of each other with the top one inverted gives around 4.5 dB increase in the mid/high section, ideal for long throw in large halls, sports stadiums, etc. Mounting the bass drivers close to each other gives the same gain at the low end. When the system is arrayed for wider angle coverage with cabinets side by side the gain is in the order of 3db.

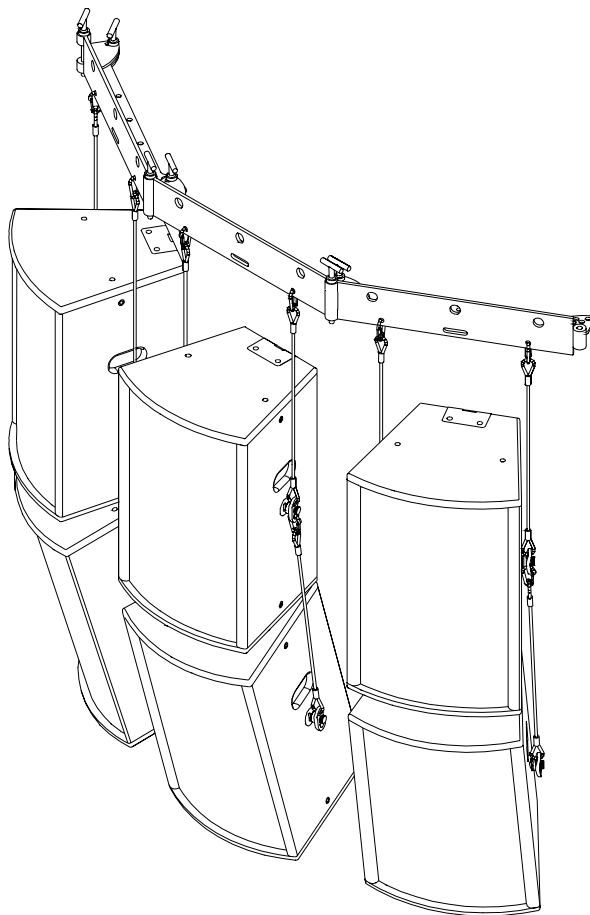

Choosing the best location

It was stated earlier that the TQ-440SP's tightly controlled directivity gives it essentially *point and shoot* qualities. Every room has its own unique set of characteristics that affect any sound introduced into the room. These include reverberation reflections and decay time, sound absorption of materials used, temperature and humidity, etc. A degree of experimentation with different locations (if possible) is best, especially if you are permanently installing the speaker and have particular requirements where you want to concentrate the sound into a specific area.

Any boundary like a wall or floor will lift certain frequencies. If you are fixing the unit to a wall, or in a corner then a lift at the bass end is to be expected and it may sound rather boomy. Either reduce the low end by means of a graphic equaliser or move the speaker.

Rooms with a lot of soft furnishings, curtains and drapes will absorb sound, especially at high frequencies. These rooms can sound rather dead and may appear to need more amplifier power to generate high SPL's but have the advantage that the sound needs less equalisation and is easier to control. In this case the listener receives mainly *direct* sound, that is the sound emanating directly from the loudspeaker, with little *reflected* sound.

If the room has a lot of hard, exposed surfaces such as wooden floors, brick or plaster walls or glass windows, these will reflect the sound, causing it to bounce around the room and sounding over bright. These rooms also tend to have various resonances that will be excited by high SPL's. Listening in the middle of the room you will hear a lot of *reflected* sound in comparison with the *direct* sound. Care is needed with speaker positioning, SPL's and equalisation. If the room is large and very reverberant then bass roll-off below about 250 Hz may be required to ensure a reasonable level of intelligibility.

For long, narrow rooms the traditional left and right stacks (floor, wall mounted or flown) can suffice with good stereo imaging in the centre of the room. For multi-tier venues such as theatres, speakers should be flown or wall mounted to project into each tier. In highly reverberant rooms often a central cluster is the best option. This acts as a virtual point source with all the sound emanating from one point in the room, but path lengths should be carefully calculated.

The relationship between sound pressure level and distance is an "inverse square law" so remember that every time the distance from the sound source is doubled the sound level decreases by 6dB. For every 3dB increase of speaker output you need a doubling of input power and you can work out the Wattage input needed to give the required SPL levels at various distances from the loudspeaker(s).

When speakers are flown in free space then boundary effects are minimised. The result is a smooth frequency response without any boost at odd frequencies, but the bass end may appear subjectively light. In this case you will need floor mounted sub-bass, to bring the low end up.

Maintenance

Should a fault develop with the amplifier module, we recommend that you remove the module as described below and return it to a qualified Turbosound service centre for repair. The module contains no user-serviceable parts, and the warranty will be invalidated if unauthorised repairs are carried out.

If one of the drive units in the cabinet should cease functioning and needs a replacement recone or diaphragm you are advised to remove the faulty unit from the cabinet and send it to a professional recone service authorised to recone Turbosound loudspeakers. This will ensure the continued high performance of your TQ-440SP.

Removal of the Amplifier module

1. Release the four M5 Allen head bolts securing the amplifier module to the rear of the cabinet and disconnect the Molex 4-way connector from the PCB. The module can now be lifted clear of the cabinet and set aside.
2. Replacement is a straightforward reversal of the above procedure. Take care to connect the Molex connector securely to the PCB (it is polarised and cannot be connected incorrectly) before replacing and tightening the four M5 Allen head bolts.

Removal of the 12"/1" driver

1. Unscrew the eight countersunk screws from the two vertical battens which hold the protective grille in place. Be careful when removing the grille as it is under tension and may spring outwards when released. Set the battens, grille and fixing screws aside for later re-assembly.
2. Undo the eight M6 x 30mm Allen head bolts holding the driver in place and carefully pull it out and away from the cabinet. **WARNING** - This unit is heavy! You will notice that the 1" high frequency driver is attached to the back of the 12" low frequency driver by its screw adapter. Disconnect the cables from both HF and LF units and completely remove the driver assembly from the cabinet. Make a note of the driver polarity for later reconnection.
3. Separate the drive units by unscrewing the high frequency driver anti-clockwise and lift it away from the low frequency driver. Depending on which section needs servicing, the appropriate drive unit should be returned to an authorised Turbosound service centre.
4. To reinstate the drivers, simply reverse the above procedure making sure you observe the correct polarity when reconnecting the cables back into the terminals of the drive units.

Removal of the midrange drive unit

If the midrange drive unit requires maintenance, it will first be necessary to remove the amplifier module. The midrange driver is held in place by a M10 x 25mm bolt through the rear of the cabinet into the back plate of the drive unit underneath the amplifier module. Once this is released the midrange horn and drive unit assembly can be removed.

1. Remove the amplifier module as described above and set it aside.
2. The M10 bolt securing the midrange driver will now be accessible in a recess in the enclosure rear panel. Using a 17mm socket, unscrew the bolt and set aside for later re-assembly.
3. Unscrew the eight countersunk screws from the two vertical battens which hold the protective grille in place. Be careful when removing the grille as it is under tension and may spring outwards when released. Set the battens, grille and fixing screws aside for later re-assembly.
4. The midrange horn is secured through the mounting flange with four #10 x 1/12" pan head wood screws. Unscrew these and lift out the horn and driver assembly.
5. Disconnect the cables, making a note of the polarity, and carefully lift the driver clear.

For any other servicing requirements please contact your Turbosound dealer or authorised service centre.

APPENDIX A

Technical Specifications

Dimensions	558mm x 409mm x 363mm (23.1" x 16.1" x 14.3")
Net weight	37.5kgs (82.5lbs)
Components	12"/1" LF/HF co-axial driver, 6.5" MF driver on a TurboMid™ device
Frequency response	55Hz – 20kHz ±4dB
Nominal dispersion	60°H x 40°V @ -6dB points
Maximum SPL	128dB continuous, 134dB peak
Construction	15mm (5/8") birch plywood throughout; rebated, screwed and glued. Finished in black semi-matt textured paint. Two recessed carrying handles. Integral 35mm pole mount. Two keyhole flyplates
Grille	Reticulated foam on expanded steel mesh
Connectors	Input: (1) XLR female; (1) XLR male, wired pin 2 hot
Mains connection	Neutrik Powercon
Options	TurboBlue semi-matt textured paint
Amplifier	Type: Class AB Power output: HF: 150 watts r.m.s. LF: 250 watts r.m.s. THD: typically 0.01%, 20Hz – 20kHz Input impedance: 10k, electronically balanced Power requirements: 230V AC 50Hz, 115V AC 60Hz

Due to continuing product improvement the above specifications are subject to change.

APPENDIX B

Spares and accessories

LS-1214	12" (305mm) LF loudspeaker
RC-1214	Recone kit for LS-1214
LS-6505	6.5" (165mm) MF loudspeaker
RC-6505	Recone kit for LS-6505
CD-103	1" (25mm) HF compression driver
RD-103	Replacement diaphragm for CD-103
PX-440SP	Internal passive crossover network
MG-440	Replacement foam / metal grille
AMP-440	Amplifier module
FM-440	Fan module

Flying accessories

EB-10	M10 shoulder eyebolt
FF-440	Flying strips (2 required per enclosure)
FB-12	Universal fly bar assembly
PP-440	Pick-up point adaptor
U-6	Unilock
SC-440	Scaffold clamp adaptor
FB-58	Modular fly bar assembly
FS-61	Flying steel long (610mm)
FS-40	Flying steel short (400mm)
TS-440	Tilt strap
BS-440	Biscuit for TQ-440
BS-440SP	Biscuit for TQ-440SP
FH-440	Flying frame and harness

APPENDIX C: WARRANTY

Limited Warranty

This Turbosound loudspeaker product is warranted to the original end-user purchaser and all subsequent owners for a period of one (1) year on electronics assemblies, and two (2) years on loudspeakers from the original date of purchase.

Warranty Coverage

Warranty coverage includes defects in materials and workmanship. It does not include:

- ◆ damage caused by accident, misuse, abuse, neglect or modification by any person other than an authorised Turbosound representative,
- ◆ damage caused by failure to operate the product in accordance with the instructions contained in the user manual,
- ◆ damage occurring during shipment in transit,
- ◆ claims based on any misrepresentation by the seller,
- ◆ products which do not have the original components as specified in the product engineering information,
- ◆ products on which the serial number has been removed or defaced.

Shipping

Should any fault develop with a component of your Turbosound system, please return the product, freight pre-paid, in its original packing carton, along with proof of purchase such as the original bill of sale or receipted invoice, and a description of the suspected fault to Turbosound Ltd. (Att: Customer Service), Star Road, Partridge Green, West Sussex RH13 8RY, England, or your local authorised Turbosound representative. The product serial number must be quoted in all correspondence relating to the claim. Insurance is recommended, as Turbosound or its representatives are not liable for loss or damage in transit. Turbosound will pay for return freight costs should repairs be covered under warranty.

Incidental and consequential damages

Turbosound's liability is limited to the repair or replacement, at our option, of any defective product, and shall not be liable for any incidental and consequential damages including, without limitation, injury to persons or property or loss of use.

Limitation of implied warranties

All implied warranties, including warranties of merchantability and fitness for a particular purpose, are limited in duration to the length of this warranty.

This warranty is in addition to, and in no way detracts from, your statutory rights as a consumer. No other warranty is expressed or implied.

Please record your purchase information below for future reference:

Dealer Name

Dealer Address

.....

.....

Post / Zip Code

Dealer telephone / fax

Invoice number

Date of purchase

Unit serial number

Turbosound Ltd.
Star Road, Partridge Green
West Sussex RH13 8RY England
Tel: +44 (0)1403 711447 Fax: +44 (0)1403 710155
web: www.turbosound.com