

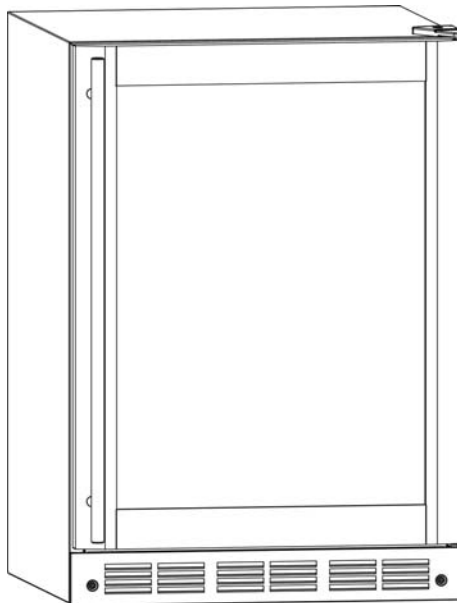

**BUILT-IN WINE & BEVERAGE COOLER  
WITH DUAL TEMPERATURE ZONES**

**INSTRUCTION MANUAL**

**Model No.: MCWBC77DZC**



**To ensure proper use of this appliance and your safety, please read the following instructions completely before operating this appliance.**

# TABLE OF CONTENTS

---

NAMES OF THE PARTS.....	2
SPECIFICATIONS.....	2
IMPORTANT SAFETY INSTRUCTIONS.....	3
INSTALLATION INSTRUCTIONS	
BEFORE USING YOUR APPLIANCE.....	3
FREE STANDING INSTALLATION.....	3
BUILT-IN INSTALLATION.....	4
ELECTRICAL CONNECTION .....	4
APPLIANCE FEATURE.....	5
OPERATING YOUR APPLIANCE	
TEMPERATURE CONTROL AND DISPLAY .....	6
INDICATOR LIGHT .....	6
STAND BY .....	6
LOCK AND UNLOCK .....	6
TEMPERATURE SETTING .....	6 – 7
INTERIOR LIGHT .....	7
AUTOMATIC DEFROST .....	7
CARE AND MAINTENANCE	
CLEANING YOUR APPLIANCE.....	7
VACATION TIME.....	7
MOVING YOUR APPLIANCE.....	7
ENERGY SAVING TIPS.....	7
TROUBLESHOOTING GUIDE.....	8
APPLIANCE WARRANTY.....	9

# NAMES OF THE PARTS

---

MODEL NO.: MCWBC77DZC

- 1) Interior Light
- 2) DC Electric Fan
- 3) Inner rear
- 4) Zone Partition
- 5) Control / Display Panel
- 6) **Wire Shelf / Glass Shelf**  
\*(Shelves are available for either wine or beverage combination storage use)
- 7) Door Handle
- 8) Partition Gasket
- 9) Tempered Glass Door

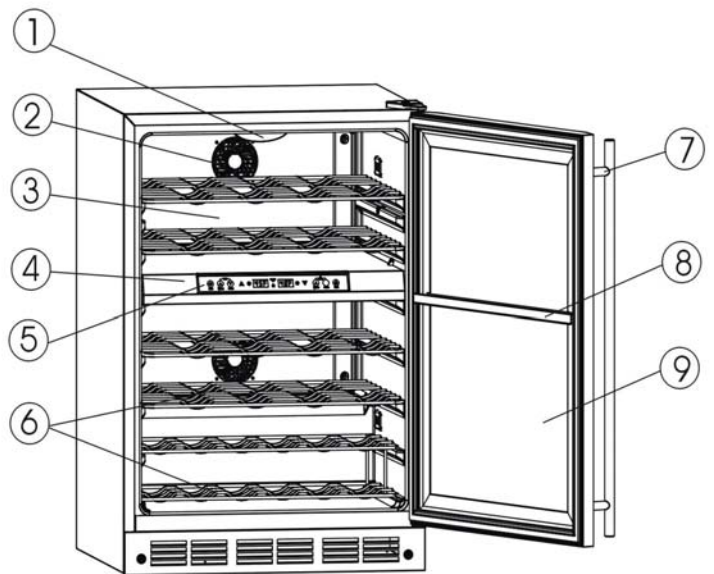

# SPECIFICATIONS – Model # MCWBC77DZC

---

Product Description	Built-In Wine & Beverage Cooler With Dual Temperature Zones		
Model No.	MCWBC77DZC		
Unit Dimensions ( inches )	Width	Height	Depth
	23.4"	34.4"	24.4"
Net Weight ( lbs)	114lbs		

# IMPORTANT SAFETY INSTRUCTIONS

<b>⚡WARNING⚡</b>	To reduce the risk of fire, electrical shock, or injury when using your appliance, follow these basic precautions:
<ul style="list-style-type: none"><li>• Read all instructions before using the wine or beverage cooler.</li><li>• <b>DANGER or WARNING:</b> Risk of child entrapment.</li><li>• To avoid the possibility of child entrapment, please take the following precautions before throwing out the appliance.<ul style="list-style-type: none"><li>- Remove all doors from the unit.</li><li>- Leave the shelves in place so that children may not easily climb inside.</li></ul></li><li>• Never allow children to operate, play with, or crawl inside the appliance.</li><li>• <b>Refrigerants:</b> All refrigeration products contain refrigerants, which under the guidelines of federal law must be removed before disposal of product. It is the consumer's responsibility to comply with federal and local regulations when disposing of this product.</li><li>• Never clean appliance parts with flammable fluids. The fumes can create a fire hazard or explosion.</li><li>• Do not store or use gasoline or any other flammable vapors and liquids in the vicinity of this or any other appliance. The fumes can create a fire hazard or an explosion.</li></ul> <p style="text-align: center;">-Save these instructions-</p>	

## INSTALLATION INSTRUCTIONS

### Before Using Your Appliance

- Remove the exterior and interior packing.
- Before connecting the appliance to the power source, let it stand upright for approximately 4 hours. This will reduce the possibility of a malfunction in the cooling system from improper handling during transportation.
- Clean the interior surface with lukewarm water using a soft cloth. (Cleaning instruction on page 7)

### Free-Standing Installation

- This appliance is designed to be **installed built-in or free standing**.
- Locate the appliance away from direct sunlight and sources of heat (stove, heater, radiator, etc.). Direct sunlight may affect the acrylic coating and heat sources may increase electrical consumption. Ambient temperature below 68°F (20°C) or above 90°F (32°C) will hinder the performance of this appliance. **This unit is not designed for use in a garage or any other outside installation.**
- Avoid locating the appliance in moist areas.
- Plug the appliance into dedicated, properly installed-grounded wall outlet. Do not under any circumstances cut or remove the third (ground) prong from the power cord. Any questions concerning power and/or grounding should be directed toward a certified electrician or an authorized service center. **This unit is not designed to be installed in an RV or used with an inverter.**
- After plugging the appliance into a wall outlet, turn the unit on and allow the unit to cool down for 3 ~ 4 hours before placing wine bottles or beverage cans in the appliance.

## **Built-In Installation**

The cutout dimension illustrated in figure (A) allows for door swing and access to the pull-out shelves when installed as a built-in appliance. If installing between frameless cabinets, a ½" wide filler strip or side panel may be needed on hinge side. The filler strip will act as a spacer between the appliance case and adjacent cabinet door swing. The width of the opening must include the filter panels.

### **Note:**

The door should protrude at least 1" beyond the surrounding cabinets.

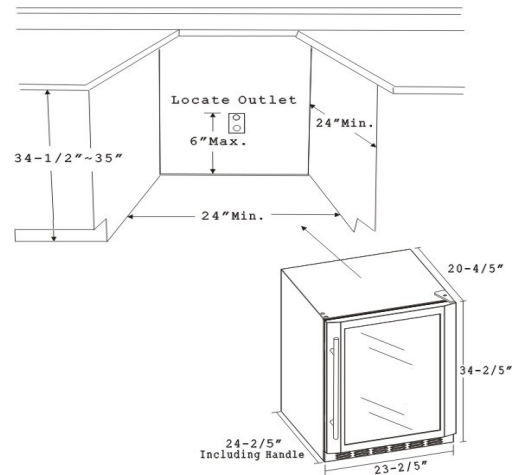

**Figure A**  
**The cutout depth must be 24".**

## **Electrical Connection**

### **⚡WARNING⚡**

Improper use of the grounded plug can result in the risk of electrical shock. If the power cord is damaged, have it replaced by an authorized service center.

This appliance should be properly grounded for your safety. The power cord of this appliance is equipped with a three-prong plug which mates with standard three prong wall outlets to minimize the possibility of electrical shock.

Do not, under any circumstances, cut or remove the third ground prong from the power cord supplied.

This appliance requires a standard 115 Volt A.C. /60Hz electrical outlet with three-prong ground.

This appliance is not designed to be used with an inverter.

The cord should be secured behind the appliance and not left exposed or dangling to prevent accidental injury.

Never unplug the appliance by pulling the power cord. Always grip the plug firmly and pull straight out from the receptacle.

Do not use an extension cord with this appliance. If the power cord is too short, have a qualified electrician or service technician install an outlet near the appliance. Use of an extension cord can negatively affect the performance of the unit.

If any problems with the appliance persist, please contact our Customer Service Dept. to consult with a representative at **888 775-0202** or visit our website to request warranty service at **[www.mcpliance.com](http://www.mcpliance.com)**.

# APPLIANCE FEATURE

## Two Temperature Zones

- There are two zones in this appliance divided by a partition.
- Each zone has its independent temperature control and display.
- Each of the two zones can be used to store wine bottles or beverages.
- The **upper zone** can hold up to **16 bottles or 63 cans**.
- The **lower zone** can hold up to **28 bottles or 77 cans**.
- Besides wine shelves made of steel wire, two glass shelves are supplied for your convenience to store beverages. Please keep the shelves that are temporarily not in use in good condition for future use.

## Interior Light

- Each zone has its own interior light, which can be switched on or off by pressing the pad  (light) on the control panel. Long-life and high efficiency LEDs are installed for durability and energy saving.

## Upper Zone

- There are two wine shelves of full depth in the upper zone. Each shelf can hold up to 8 bottles with the bottle necks alternating front to back.
- The second supporting guide in the upper zone (counted from top, see illustration "A" on this page) is not designed for wine shelves. It is for beverage shelves only.

## Lower Zone

- There are also two wine shelves of full depth in the lower zone. Each shelf can hold up to 8 bottles with the bottle necks alternating front to back.
- The bottom rack in the lower zone, which consists of two stories, each holds up to 6 bottles with bottle necks facing the front (see illustration below on this page).

## Engaged Wine Shelves

- All the wine shelves and glass shelves of full depth have tabs to engage the cabinet on both sides.
- Any of the shelves can be removed to accommodate larger bottles.

### To Remove a Shelf:

- Remove all bottles from the shelves.
- Lift the shelf upwards and then gently pull out the shelves.

### To Replace a Shelf:

- Place the sides of the shelves back onto the supporting guides of the cabinet and push back until the shelf tabs slide into place.



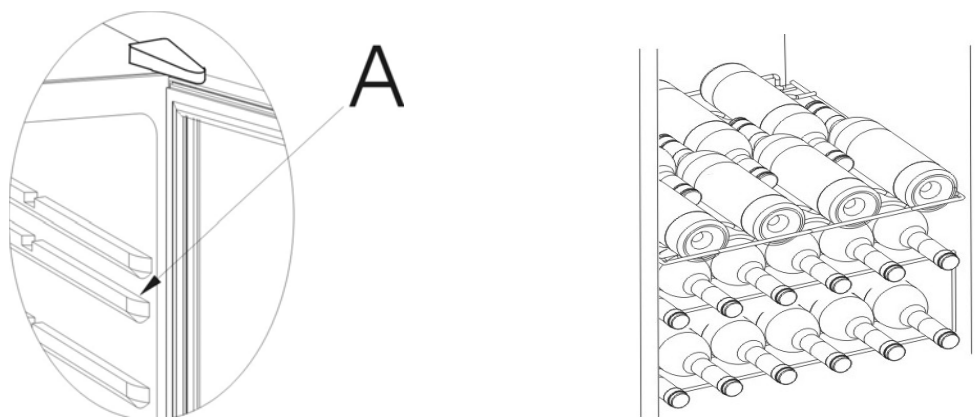









**NOTE: Ensure that the tabs are firmly engaged in place before storing any bottles.**







# OPERATING YOUR APPLIANCE

## Temperature Control and Display







1. The temperatures in upper zone and lower zone can be independently controlled and displayed.
2. The temperature in either zone can be controlled between 39°F to 61°F (4°C to 16°C). (The zone temperature may have a tolerance of +/-5°F (+/-3°C) from setting depending on different loading and ambient conditions.)
3. The temperature display, indicator , control pads  (warmer) and  (colder) near the symbol  (left side) are for upper zone of the wine cooler.
4. The temperature display, indicator , control pads  (warmer) and  (colder) near the symbol  (right side) are for lower zone of the wine cooler.
5. The indicators  and , and the control pads  (lock) and  (light) are for both zones.



## Indicators Lights

- When it lights, the indicator  indicates the unit is in the mode of “stand by”.
- When it lights, the indicator  indicates all control pads are locked except the pad  (lock), which can be used to unlock.
- When it lights, the indicator  indicates the corresponding zone is in refrigeration cycle. The indicator  will go off when the set temperature is met.



## Standby

1. Whenever the unit is switched on, all the display and indicators will light for 3 seconds with a beep sound. Then the unit will automatically resume its previous setting when it was switched off. If the unit was previously in “stand by” mode when switched off, it will resume the mode of “stand by” and the indicator  will light.
2. You can manually set your unit to the mode of “stand by” by pressing and holding both pads  (warmer) and  (colder) for the lower zone for approximately 3 seconds, provided the pads are unlocked and no any other setting operation is in process (Display does not flash). The indicator  will light to confirm this setting.







## Lock and Unlock

If no pad is pressed within 1 minute then all control pads will be automatically locked except the pad  (lock), which can be used to unlock. You can also manually lock them by pressing the pad  (lock) before they are automatically locked.



Under locked condition, no pad pressing will function but the indicator  will flash for 5 seconds to remind you that the pad being pressed is locked.

**A pad functions only when it is unlocked. To unlock, press and hold the pad  (lock) for 3 seconds until the indicator  goes off.**

## Temperature setting

- In normal condition, the temperature display indicates instant temperature of the corresponding zone. During the setting operation, the temperature display flashes to remind that temperature setting is in process.
- The temperature in both upper zone and lower zone can be set separately by pressing pads  (warmer) or  (colder) respectively corresponding to that zone. The temperature of both zones can be set anywhere between 39°F to 61°F (4°C to 16°C).
- When the pad  (warmer) or  (colder) is pressed, the temperature displayed will increase or decrease in an increment of one degree. If the pad  (warmer) or  (colder) is pressed and held for 2 seconds, the temperature displayed will increase or decrease in a speed of one degree per half second.
- During the setting operation, the temperature displayed flashes until no pad is pressed within approximately 3 seconds. Then your last setting is recorded and confirmed by that the display stops flashing but to indicate instant temperature of that zone.

**Note:**

The temperature display can be changed between Celsius and Fahrenheit by pressing and holding both pads  (warmer) and  (colder) for the upper zone for approximately 3 seconds, provided the pads are unlocked and no any other setting operation is in process (Display does not flash).

**Interior Light**

You can press the pad  (light) to switch the interior light on/off, provided the pads are unlocked and no any other setting operation is in process (Display does not flash).

## AUTOMATIC DEFROST

There is no need for manual defrosting of this appliance due to automatic defrosting function.

- The ice build-up on the inner back wall during compressor operation will be automatically defrosted in a compressor off cycle.
- When defrosting is in process, the indicators  for both zones will go off, and the circulation fans for both zones will run.
- Defrost water will drain out passing through the drain outlet in the inner back wall into a drain pan located above the compressor, from where it evaporates.

## CARE AND MAINTENANCE

**Cleaning Your Appliance**

- Upon installation of your new appliance, it is recommended that it be cleaned thoroughly.
- Turn off the appliance first and then unplug the unit from the wall outlet.
- Remove all contents.
- Wash the inside with a damp warm cloth soaked in lukewarm water and baking soda solution. The solution should be about 2 tablespoons of baking soda to a quart of water.
- Be sure to keep the door gasket (seal) clean to keep the unit running efficiently.
- The outside of the appliance should be cleaned with mild detergent and warm water.
- Dry the interior and exterior with a soft cloth.
- Dust or anything else blocking the vent may hinder the cooling efficiency of the appliance. Vacuum the vent if necessary.

**Vacation Time**

- Turn off the appliance first and then unplug the unit from the wall outlet.
- Remove all the contents.
- Clean the appliance.
- Leave the door open slightly to avoid possible formation of condensation, mold, or odors.
- Short vacations: Leave the appliance operating during vacations of less than three weeks.
- Long vacations: If the appliance will not be used for several months, remove all content and unplug the power cord. Clean and dry the interior thoroughly. To prevent odor and mold growth, leave the door open slightly: blocking it open if necessary.

**Moving Your Appliance**

- Turn off the appliance first and then unplug the unit from the wall outlet.
- Remove all the contents.
- Securely tape down all loose items inside your appliance.
- Tape the doors shut.

**Energy Saving Tips**

- The appliance should be located in the coolest area of the room, away from heat producing appliances or heating ducts, and out of the direct sunlight.
- Ensure that door is closed when the appliance is turned on.



# TROUBLESHOOTING GUIDE

---

You can solve many common appliance problems easily, saving you the cost of a possible service call. Try the suggestions below to see if you can solve the problem before calling for service.

PROBLEM	POSSIBLE CAUSE
Appliance does not operate.	Not plugged in. The circuit breaker tripped or a blown fuse.
Temperature inside the appliance is too warm.	Temperature control is set too warm. Turn the control to a cooler setting and allow several hours for the temperature to stabilize. Door is kept open too long or is opened too frequently. Warm air enters the appliance every time the door is opened. Open the door less often. The door is not closed completely. The door gasket does not seal properly. The appliance has recently been disconnected for a period of time. 4 hours are required for the appliance to cool down completely.
Temperature inside the appliance is too cold.	Temperature control is set too cold. Turn the control to a warmer setting and allow several hours for the temperature to stabilize.
Vibrations.	Check to assure that the appliance is on a level surface. The appliance is touching the wall. Re-level the appliance and move it from the wall. If continued vibration occurs, turn off the appliance and unplug the power plug. Contact Customer Service Dept. for further assistance.
Moisture forms on inside appliance walls.	Door is slightly open. Door is kept open too long, or is opened too frequently. Open the door less often. The door is not sealed properly.
Moisture forms on outside of appliance.	Door is slightly open, causing cold air from inside the appliance to meet warm moist air from outside.
The door will not close properly.	The appliance is not on a level surface. The gasket is dirty.
Abnormal display on control panel	"E1" on display for upper zone – error of temperature sensor for upper zone. "E2" on display for lower zone – error of temperature sensor for lower zone. "E3" on display for upper zone – error of DC electric fan for upper zone. "E4" on display for lower zone – error of DC electric fan for lower zone. If any of above errors happens, please contact Customer Service Dept. for further assistance. Do not attempt to repair it yourself.



## Appliance Warranty

**MC Appliance Corporation** warrants each new appliance to be free from defects in material and workmanship and agrees to remedy any such defect or to furnish a new part(s) (at the company's option) for any part(s) of the unit that has failed during the warranty period. Parts and labor expenses are covered on this unit for a period of one year after the date of purchase. In addition, MC Appliance Corp. warrants the compressor (parts only) to be free from defects in material and workmanship for a period of 5 years. The consumer is responsible for all labor and transportation expenses related to the diagnosis and replacement of the compressor after the initial one-year warranty expires. If in the event that the unit is determined to be non-repairable under the terms of this warranty, the consumer is responsible for all transportation expenses to return the unit to our factory prior to receiving a refund. **A copy of the dated sales receipt / invoice is required to receive warranty service or a refund.**

**This warranty covers appliances in use within the continental United States, Puerto Rico and Hawaii. The warranty does not cover the following:**

- Damages due to shipping damage or improper installation.
- Damages due to misuse or abuse.
- Content losses due to failure of the unit.
- Inside components such as door panels, door shelves, racks, light bulbs, etc.
- Punctures to the evaporator system due to improper defrosting of the unit.
- Repairs performed by unauthorized service agents.
- Service calls that do not involve defects in material and workmanship such as instruction on proper use of the product, door reversal or improper installation.
- Replacement or resetting of house fuses or circuit breakers.
- Failure of this product if used for other than for its intended purpose.
- Disposal costs for any failed unit not returned to our factory.
- Any delivery costs incurred as the result of a unit that fails to perform as specified.

**This warranty is in lieu of all warranties expressed or implied and no representative or person is authorized to assume for us any other liability in connection with the sale of this product. Under no circumstances is the consumer permitted to return this unit to the factory without prior written consent from MC Appliance Corporation.**

Model	Parts	Labor	Compressor (part only)	Type of Service
<b>MCWBC77DZC</b>	One-Year	One-Year	Five-Year	In-Home

For Service or Assistance please call **888 775- 0202**. Or visit us on the web at **[www.mcappliance.com](http://www.mcappliance.com)** to request warranty service.