

# User's Manual

RadiForce®  
RX430  
RX430-AR  
RX430-FC

Color LCD Monitor

## Important

Please read PRECAUTIONS, this User's Manual, and Setup Manual (separate volume) carefully to familiarize yourself with safe and effective usage.

- 
- Please refer to the Setup Manual for basic information ranging from connection of the monitor to a PC to using the monitor.
  - The latest User's Manual is available for download from our web site:  
<http://www.radiforce.com>
- 



Product specification may vary with sales areas. Confirm the specification in the manual written in language of the region of purchase.

---

Copyright© 2011 EIZO NANAO CORPORATION All rights reserved.

No part of this manual may be reproduced, stored in a retrieval system, or transmitted, in any form or by any means, electronic, mechanical, or otherwise, without the prior written permission of EIZO NANAO CORPORATION. EIZO NANAO CORPORATION is under no obligation to hold any submitted material or information confidential unless prior arrangements are made pursuant to EIZO NANAO CORPORATION's receipt of said information. Although every effort has been made to ensure that this manual provides up-to-date information, please note that EIZO monitor specifications are subject to change without notice.

---

# Notice for this monitor

---

---

This product is suited to display medical images of such modalities as MRI, CT, PET, and operating room (RX430-FC only). It does not support the display of mammography images for diagnosis.

---

This product has been adjusted specifically for use in the region to which it was originally shipped. If the product is used outside the region, it may not operate as specified in the specifications.

---

This product may not be covered by warranty for uses other than those described in this manual.

---

The specifications noted in this manual are only applicable for power cords and signal cables specified by us.

---

Use optional products manufactured or specified by us with this product.

---

As it takes about 30 minutes for the performance of electrical parts to stabilize, adjust the monitor 30 minutes or more after the monitor power has been turned on.

---

In order to suppress the luminosity change by long-term use and to maintain the stable luminosity, use of a monitor in lower brightness is recommended.

---

When the screen image is changed after displaying the same image for extended periods of time, an afterimage may appear. Use the screen saver or power save function to avoid displaying the same image for extended periods of time.

---

Periodic cleaning is recommended to keep the monitor looking new and to prolong its operation lifetime (refer to [“Cleaning” \(page 4\)](#)).

---

The screen may have defective pixels or a small number of light dots on the screen. This is due to the characteristics of the panel itself, and not the product.

---

The backlight of the LCD panel has a fixed life span. When the screen becomes dark or begins to flicker, please contact your dealer.

---

Do not press on the panel or edge of the frame strongly, as this may result in the display malfunction, such as the interference patterns, etc. If pressure is continually applied to the panel, it may deteriorate or damage your panel. (If the pressure marks remain on the panel, leave the monitor with a white or black screen. The symptom may disappear.)

---

Do not scratch or press on the panel with any sharp objects, as this may result in damage to the panel. Do not attempt to brush with tissues as this may scratch the panel.

---

When the monitor is cold and brought into a room or the room temperature goes up quickly, dew condensation may occur inside and outside the monitor. In that case, do not turn the monitor on and wait until dew condensation disappears, otherwise it may cause some damages to the monitor.

---

## Cleaning

---

### Attention

- Never use any solvents or chemicals, such as thinner, benzene, wax, alcohol, and abrasive cleaner, which may damage the cabinet or panel.

### Note

- Optional ScreenCleaner is recommended for cleaning the panel surface. (“ScreenCleaner” is supplied with RX430-FC.)

### ● Panel

- Clean the panel with a soft cloth such as cotton cloth or lens cleaning paper.
- If necessary, stubborn stains can be removed by moistening part of a cloth with water to enhance its cleaning power. After that, clean the panel again with a dry cloth for better finishing.

### ● Cabinet

- Clean the cabinet with a soft cloth dampened with a little mild detergent.

## To use the monitor comfortably

---

- An excessively dark or bright screen may affect your eyes. Adjust the brightness of the monitor according to the environmental conditions.
- Staring at the monitor for a long time tires your eyes. Take a 10-minute rest every hour.

# CONTENTS

<b>Cover</b> .....	<b>1</b>		
<b>Notice for this monitor</b> .....	<b>3</b>		
<b>CONTENTS</b> .....	<b>5</b>		
<b>Chapter 1 Introduction</b> .....	<b>7</b>		
<b>1-1. Features</b> .....	<b>7</b>		
<b>1-2. EIZO LCD Utility Disk</b> .....	<b>8</b>		
● Disk contents and software overview .....	<b>8</b>		
● To use RadiCS LE/ScreenManager Pro for Medical .....	<b>8</b>		
<b>1-3. Basic Operations and Functions</b> .....	<b>9</b>		
● Basic Adjustment menu operations .....	<b>9</b>		
● Functions .....	<b>10</b>		
<b>Chapter 2 Adjusting Screens</b> .....	<b>11</b>		
<b>2-1. Setting the Resolution</b> .....	<b>11</b>		
● Display resolution .....	<b>11</b>		
● Setting resolution .....	<b>11</b>		
Windows 7 .....	<b>11</b>		
Windows Vista .....	<b>11</b>		
Windows XP .....	<b>11</b>		
Mac OS X .....	<b>11</b>		
<b>2-2. Adjusting Color</b> .....	<b>12</b>		
● To select the display mode (CAL Switch mode) .....	<b>12</b>		
● To perform advanced adjustments .....	<b>12</b>		
● Adjustable settings in each mode .....	<b>13</b>		
● To adjust brightness <Brightness> .....	<b>13</b>		
● To adjust contrast <Contrast> .....	<b>14</b>		
● To adjust color temperature <Temperature> ..	<b>14</b>		
● To adjust gamma <Gamma> .....	<b>15</b>		
● To adjust hue <Hue> .....	<b>15</b>		
● To adjust the color saturation <Saturation> ..	<b>15</b>		
● To adjust gain <Gain> .....	<b>16</b>		
● To set the mode in the monochrome display area <Hybrid Area> .....	<b>16</b>		
● To set the detection type in the monochrome image display area <Detection Type> .....	<b>17</b>		
● To set the highlight area in the monochrome display area <Highlight Area> ..	<b>17</b>		
<b>2-3. Screen Size Selection</b> .....	<b>18</b>		
● To change screen size <Screen Size> .....	<b>18</b>		
<b>Chapter 3 Setting Monitor</b> .....	<b>19</b>		
<b>3-1. Enabling/Disabling Mode Selection &lt;Mode Preset&gt;</b> .....	<b>19</b>		
<b>3-2. Setting Language &lt;Language&gt;</b> .....	<b>19</b>		
<b>3-3. Setting Adjustment Menu Display</b> .....	<b>19</b>		
● Changing Adjustment Menu Display Position <Menu Position> .....	<b>19</b>		
<b>3-4. Setting the EIZO Logo Display &lt;Logo&gt;</b> .....	<b>20</b>		
<b>3-5. Locking Buttons &lt;Key Lock&gt;</b> .....	<b>20</b>		
<b>3-6. Enabling/Disabling DDC communication</b> .....	<b>20</b>		
<b>3-7. Enabling/Disabling DC5V output</b> .....	<b>21</b>		
<b>3-8. Setting the Input Signals &lt;Signal Selection&gt;</b> .....	<b>21</b>		
<b>3-9. Return To Default Setting</b> .....	<b>22</b>		
● To reset the color adjustment value <Color Reset> .....	<b>22</b>		
● To reset all adjustments to the default settings <All Reset> .....	<b>22</b>		
<b>Chapter 4 Controlling Monitor Quality</b> .....	<b>23</b>		
<b>4-1. Executing Calibration &lt;SelfCalibration&gt;</b> ..	<b>23</b>		
● Executing SelfCalibration .....	<b>23</b>		
● Viewing SelfCalibration result .....	<b>23</b>		
<b>4-2. Checking Grayscale &lt;Grayscale Check&gt;</b> ..	<b>24</b>		
● Executing Grayscale Check .....	<b>24</b>		
● Viewing Grayscale Check result .....	<b>24</b>		
<b>4-3. Setting On/Off for Warning and QC History &lt;Settings&gt;</b> .....	<b>24</b>		
<b>Chapter 5 Power Saving Functions</b> .....	<b>25</b>		
<b>5-1. Setting Power Saving &lt;Power Save&gt;</b> .....	<b>25</b>		
<b>5-2. Setting Power Indicator &lt;Power Indicator&gt;</b> .....	<b>25</b>		
<b>5-3. Setting the power saving mode when a person leaves the monitor &lt;Presence Sensor&gt;</b> .....	<b>26</b>		
<b>Chapter 6 Troubleshooting</b> .....	<b>27</b>		
Error Code table .....	<b>29</b>		
<b>Chapter 7 Reference</b> .....	<b>31</b>		
<b>7-1. How to Attach the Optional Arm</b> .....	<b>31</b>		
<b>7-2. Connecting Multiple PCs</b> .....	<b>32</b>		
● To switch among input signals <Input> .....	<b>32</b>		
● To set input signal selection <Input Selection> .....	<b>33</b>		
<b>7-3. Making Use of USB (Universal Serial Bus)</b> .....	<b>34</b>		
● Required System Environment .....	<b>34</b>		
● Connection Procedure (Setup of USB Function) .....	<b>34</b>		
<b>7-4. Displaying monitor information</b> .....	<b>35</b>		
● Displaying signal information <Signal Info> ..	<b>35</b>		
● Displaying Monitor Information <Monitor Info> .....	<b>35</b>		
<b>7-5. Specifications</b> .....	<b>36</b>		
<b>7-6. Glossary</b> .....	<b>39</b>		

<b>Appendix</b> .....	<b>41</b>
Trademark .....	41
License .....	41
Medical Standard .....	42
FCC Declaration of Conformity .....	43
EMC Information .....	44
LIMITED WARRANTY .....	47
China Measures for RoHS Compliance in ChinaRoHS .....	54

# Chapter 1 Introduction

Thank you very much for choosing an EIZO color LCD monitor.

## 1-1. Features

- 29.8 inches
- Applicable to the resolution of 4M pixels (2560 × 1600 dots)
- Uses high-contrast panel (1100:1).  
Enables the display of sharp images.
- Applicable to DisplayPort (applicable to 8 bit or 10 bit, not applicable to audio signals)
- The Hybrid Gamma function automatically identifies the display area for the monochrome and color images on the same screen, and displays each set status.
  - \* The identification may fail depending on the displayed image. The software to be used needs to be verified.
- The RadiCS SelfQC function and the built-in Integrated Front Sensor allow the user to perform the calibration and Grayscale Check for the monitor independently.  
See “[Chapter 4 Controlling Monitor Quality](#)” (page 23)
- The quality control software “RadiCS LE (for Windows) used to calibrate the monitor and to manage the history is included  
See “[1-2. EIZO LCD Utility Disk](#)” (page 8)
- The software “ScreenManager Pro for Medical” to adjust the screen using the mouse and keyboard is included  
See “[1-2. EIZO LCD Utility Disk](#)” (page 8)
- CAL Switch function for selecting an optimal calibration mode  
See “[To select the display mode \(CAL Switch mode\)](#)” (page 12).
- Selectable DICOM (page 39) Part 14 complied screen.
- Frame Synchronous mode supported (29.5 to 30.5 Hz, 59 to 61 Hz)
- Power saving function  
This product is equipped with power saving function.
  - Power Consumption when main power switch is Off: 0 W  
Equipped with main power switch.  
Turning off the main power switch completely shuts off power supply to the monitor while the monitor is not used.
  - Presence Sensor  
The sensor on the front side of the monitor detects the movement of a person. When a person moves away from the monitor, it shifts to the power saving mode automatically and does not display the images on the screen. Therefore, the function reduces the power consumption.  
See “[5-3. Setting the power saving mode when a person leaves the monitor <Presence Sensor>](#)” (page 26).
- Built-in illuminance sensor
- HDCP (High-bandwidth Digital Content Interface)
- Panel protector is included (for RX430-FC only).

---

**Attention**

- Storing or using the monitor at a temperature of under 30°C and a humidity of under 70% is recommended, or it may affect the measurement accuracy of the built-in sensor. Avoid storing or using the sensor where it may be exposed to direct sunlight.
-

## 1-2. EIZO LCD Utility Disk

An “EIZO LCD Utility Disk” (CD-ROM) is supplied with this product. The following table shows the disk contents and the overview of the software programs.

### ● Disk contents and software overview

The disk includes software programs for adjustment, and User's Manual. Refer to Readme.txt file on the disk for software startup procedures or file access procedures.

Item	Overview
Readme.txt file	
RadiCS LE (for Windows)	RadiCS LE is quality control software used to calibrate the monitor and manage the calibration history.
ScreenManager Pro for Medical (for Windows)	A software for adjusting the screen using the mouse and keyboard.
User's Manual of this monitor (PDF file)	

### ● To use RadiCS LE/ScreenManager Pro for Medical

For the installation and use of “RadiCS LE/ScreenManager Pro for Medical”, refer to the respective User's Manual on the disk.

When using this software, you will need to connect a PC to the monitor with the supplied USB cable. For more information refer to the [“7-3. Making Use of USB \(Universal Serial Bus\)” \(page 34\)](#).



# 1-3. Basic Operations and Functions

## ● Basic Adjustment menu operations

### 1. Displaying Adjustment Menu

1. Press ENTER. The Adjustment menu appears.

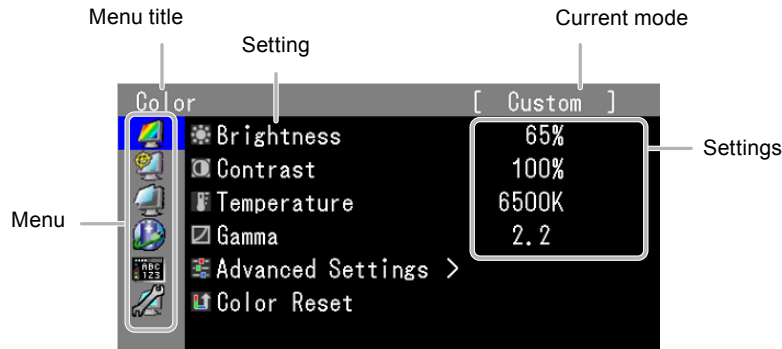

### 2. Adjusting/Setting

1. Choose a menu to adjust/set with ▲,▼, and then press ENTER.

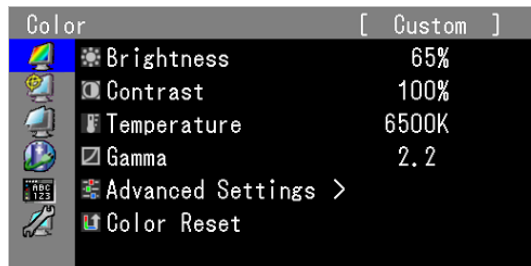

2. Choose a menu to adjust/set with ▲,▼, and then press ENTER.

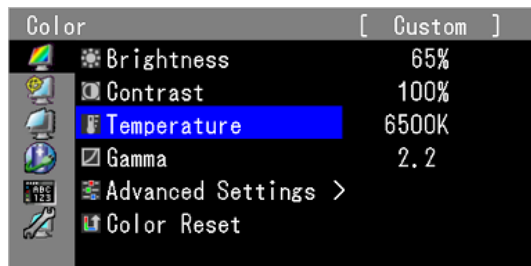

3. Adjust/set the selected item with ▲,▼, and then press ENTER.

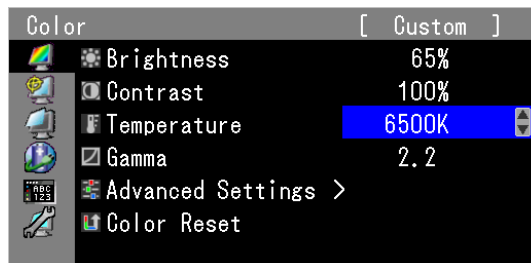







### 3. Exiting

1. Press RETURN a few times. The Adjustment menu finishes.

## ● Functions

The following table shows all the Adjustment menu's adjustment and setting menus.

Main menu	Setting	Reference	
Color 	Brightness	"2-2. Adjusting Color" (page 12)	
	Contrast		
	Temperature		
	Gamma		
	Advanced Settings		Hue
			Saturation
			Gain
	Hybrid Area		
	Detection Type		
Highlight Area	"3-9. Return To Default Setting" (page 22)		
Color Reset			
RadiCS SelfQC 	SelfCalibration	"4-1. Executing Calibration <SelfCalibration>" (page 23)	
	Grayscale Check	"4-2. Checking Grayscale <Grayscale Check>" (page 24)	
	Settings	"4-3. Setting On/Off for Warning and QC History <Settings>" (page 24)	
Screen 	Screen Size	"2-3. Screen Size Selection" (page 18)	
Power Manager 	Power Save	"5-1. Setting Power Saving <Power Save>" (page 25)	
	Presence Sensor	"5-3. Setting the power saving mode when a person leaves the monitor <Presence Sensor>" (page 26)	
	Power Indicator	"5-2. Setting Power Indicator <Power Indicator>" (page 25)	
Menu Settings 	Language	"3-2. Setting Language <Language>" (page 19)	
	Menu Position	"3-3. Setting Adjustment Menu Display" (page 19)	
Tools 	Input	"To switch among input signals <Input>" (page 32)	
	Input Selection	"To set input signal selection <Input Selection>" (page 33)	
	Mode Preset	"3-1. Enabling/Disabling Mode Selection <Mode Preset>" (page 19)	
	Signal Info	"7-4. Displaying monitor information" (page 35)	
	Monitor Info		
	All Reset	"3-9. Return To Default Setting" (page 22)	

\* The adjustment/settings available on <Color> depend on the selected mode. (See "2-2. Adjusting Color" (page 12))

# Chapter 2 Adjusting Screens

## 2-1. Setting the Resolution

### ● Display resolution

For details on compatible resolutions, refer to “Compatible Resolutions” in the Setup Manual.

### ● Setting resolution

When you connect the monitor to the PC and find that the resolution is improper, or when you want to change the resolution, follow the procedure below.

#### Windows 7

1. Right-click the mouse anywhere on the desktop except for icons.
2. From the displayed menu, click “Screen resolution”.
3. On the “Screen Resolution” dialog box, select the monitor.
4. Click “Resolution” to select the desired resolution.
5. Click the [OK] button.
6. When a confirmation dialog box is displayed, click [Keep changes].

#### Windows Vista

1. Right-click the mouse anywhere on the desktop except for icons.
2. From the displayed menu, click “Personalize”.
3. On the “Personalization” window, click “Display Settings”.
4. On the “Display Settings” dialog box, select the “Monitor” tab and select desired resolution in the “Resolution” field.
5. Click the [OK] button.
6. When a confirmation dialog box is displayed, click [Yes].

#### Windows XP

1. Right-click the mouse anywhere on the desktop except for icons.
2. From the displayed menu, click “Properties”.
3. When the “Display Properties” dialog box is displayed, click the “Settings” tab and select desired resolution for “Screen resolution” under “Display”.
4. Click the [OK] button to close the dialog box.

#### Mac OS X

1. Select “System Preferences” from the “Apple” menu.
2. When the “System Preferences” dialog box is displayed, click “Displays” for “Hardware”.
3. On the displayed dialog box, select the “Display” tab and select desired resolution in the “Resolutions” field.
4. Your selection will be reflected immediately. When you are satisfied with the selected resolution, close the window.

## 2-2. Adjusting Color

### ● To select the display mode (CAL Switch mode)

This function allows easy selection of a desired mode according to monitor application.

#### Display Modes

Mode	Purpose
1-DICOM	Available to display in DICOM mode.
2-Custom	Select one of these user modes to define a desired set of parameter settings.
3-CAL1	Displays the screen adjusted by calibration software.
4-CAL2	
5-CAL3	
6-Hybrid- $\gamma$	Automatically identifies the display area for the monochrome and color images on the same screen, and displays each set status.
7-sRGB	Suitable for color matching with sRGB compatible peripherals.
8-Text	Suitable for displaying texts for word processing or spreadsheets.

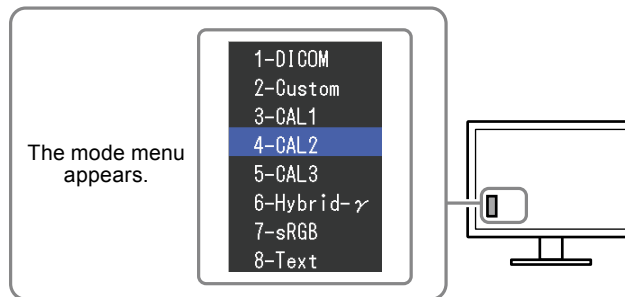

#### Procedure

1. Press MODE.

The mode menu appears at the bottom left of the screen.

2. The mode among the list is highlighted in turn each time MODE is pressed.

You can switch the mode with ▲ or ▼ while the mode menu is displayed.

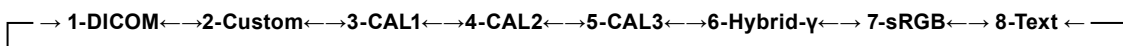

#### Note

- The Adjustment menu and the Mode menu cannot be displayed at the same time.

### ● To perform advanced adjustments

<Color> of the Adjustment menu allows you to configure and save a separate set of color settings for each mode.

#### Attention

- The monitor will take about 30 minutes before its internal electric components stabilize. Wait 30 minutes or more after turning the monitor power on before starting adjustment.
- The same image may be seen in different colors on multiple monitors due to their monitor-specific characteristics. Make fine color adjustment visually when matching colors on multiple monitors.











#### Note

- The values shown in “%” or “K” are available only as reference.

## ● Adjustable settings in each mode

The adjustable settings depend on the mode. (You cannot select any non-adjustable or non-settable function.)

√: Adjustable - : Not adjustable

Icon	Function	CAL Switch mode					
		1-DICOM*	2-Custom*	3-CAL1* 4-CAL2* 5-CAL3*	6-Hybrid-γ	7-sRGB	8-Text
	Brightness	√	√	√	-	√	√
	Contrast	-	√	-	-	-	√
	Temperature	-	√	-	-	√	√
	Gamma	-	√	-	-	-	√
	Hue	-	√	-	-	-	√
	Saturation	-	√	-	-	-	√
	Gain	-	√	-	-	-	-
	Hybrid Area	-	-	-	√	-	-
	Detection Type	-	-	-	√	-	-
	Highlight Area	-	-	-	√	-	-
	Color Reset	√	√	√	√	√	√

\* If you adjust the calibration in this mode using the calibration kit exclusive for to this monitor (see RadiCS LE / "Accessories" (page 38)), only <Brightness> and <Color Reset> are adjustable.

## ● To adjust brightness <Brightness>

The screen brightness is adjusted by changing the brightness of the backlight (light source from the LCD back panel).

### **Adjustable range**

0 to 100%

### **Procedure**

1. Choose <Color> from the Adjustment menu, and press ENTER.
2. Choose <Brightness> from <Color>, and press ENTER.
3. Use ▲ or ▼ for adjustment.
4. Press ENTER to exit.

### **Note**

- If you feel that the image is too bright even if the brightness is set to 0%, adjust the contrast.

## ● To adjust contrast <Contrast>

The luminance of the screen is adjusted by varying the video signal level.

### **Adjustable range**

0 to 100%

### **Procedure**

1. Choose <Color> from the Adjustment menu, and press ENTER.
2. Choose <Contrast> from <Color>, and press ENTER.  
The <Contrast> appears.
3. Use ▲ or ▼ for adjustment.
4. Press ENTER to exit.

---

#### **Note**

- In the contrast of 100%, every color gradation is displayed.
  - When adjusting the monitor, it is recommended to perform the brightness adjustment which may not lose the gradation characteristics, prior to the contrast adjustment.
  - Perform the contrast adjustment in the following cases.
    - When you feel the image is too bright even if the brightness is set to 0% (Set the contrast to lower than 100%)
- 

## ● To adjust color temperature <Temperature>

The color temperature can be adjusted.

The color temperature is normally used to express the hue of “White” and/or “Black” by a numerical value.

The value is expressed in degrees “K” (Kelvin).

The screen becomes reddish at a low color temperature, and bluish at a high color temperature, like the flame temperature. The gain preset values are set for each color temperature setting value.

### **Adjustable range**

Native, 6000K-15000K (specified every 100K), Standard

### **Procedure**

1. Choose <Color> from the Adjustment menu, and press ENTER.
2. Choose <Temperature> from <Color>, and press ENTER.
3. Use ▲ or ▼ for adjustment.
4. Press ENTER to exit.

---

#### **Note**

- <Gain> allows you to perform more advanced adjustment (see “To adjust gain <Gain>” (page 16)).
  - If you set “Native”, the image is displayed in the preset color of the monitor (Gain: 100% for each RGB).
  - When gain is changed, the color temperature is changed to “User”.
-

## ● To adjust gamma <Gamma>

Gamma can be adjusted. The brightness of the monitor varies depending on the input signal, however, the variation rate is not proportional to the input signal. To keep the balance between the input signal and the brightness of the monitor is called as “Gamma correction”.

### **Adjustable range**

1.6 to 2.7

### **Procedure**

1. Choose <Color> from the Adjustment menu, and press ENTER.
2. Choose <Gamma> from <Color>, and press ENTER.
3. Use ▲ or ▼ for adjustment.
4. Press ENTER to exit.

## ● To adjust hue <Hue>

This function allows you to adjust the hue.

### **Adjustable range**

-100 to 100

### **Procedure**

1. Choose <Color> from the Adjustment menu, and press ENTER.
2. Choose <Advanced Settings> from <Color>, and press ENTER.
3. Choose <Hue>, and press ENTER.
4. Use ▲ or ▼ for adjustment.
5. Press ENTER to exit.

---

#### **Attention**

- Using this function may make some color gradations unavailable for display.
- 

## ● To adjust the color saturation <Saturation>

This function allows you to adjust color saturation.

### **Adjustable range**

-100 to 100

### **Procedure**

1. Choose <Color> from the Adjustment menu, and press ENTER.
2. Choose <Advanced Settings> from <Color>, and press ENTER.
3. Choose <Saturation>, and press ENTER.
4. Use ▲ or ▼ for adjustment.
5. Press ENTER to exit.

---

#### **Attention**

- Using this function may make some color gradations unavailable for display.
- 

#### **Note**

- The minimum value (-100) changes the screen to monochrome.
-

## ● To adjust gain <Gain>

The brightness of each color component red, green, and blue is called “Gain”. You can change the hue of “white” by adjusting gain.

### **Adjustable range**

0 to 100%

### **Procedure**

1. Choose <Color> from the Adjustment menu, and press ENTER.
2. Choose <Advanced Settings> from <Color>, and press ENTER.
3. Choose <Gain>, and press ENTER.
4. Choose the color to adjust from <Red>, <Green>, and <Blue>, and then press ENTER.
5. Use ▲ or ▼ for adjustment.
6. Press ENTER to exit.

---

### **Attention**

- Using this function may make some color gradations unavailable for display.

### **Note**

- The value of gain changes with that of color temperature.
  - When gain is changed, the color temperature is changed to “User”.
- 

## ● To set the mode in the monochrome display area <Hybrid Area>

The mode suitable for the monochrome image display area can be set (see “[To select the display mode \(CAL Switch mode\)](#)” (page 12)).

### **Adjustable range**

DICOM, CAL1, CAL2, CAL3

### **Procedure**

1. Choose <Color> from the Adjustment menu, and press ENTER.
2. Choose <Hybrid Area> from <Color>, and press ENTER.
3. Use ▲ or ▼ for adjustment.
4. Press ENTER to exit.

---

### **Attention**

- You cannot select any mode for which Mode Preset is “Off” (see “[3-1. Enabling/Disabling Mode Selection <Mode Preset>](#)” (page 19)).
- If all <Mode Preset> for DICOM/CAL1/CAL2/CAL3 are set to “Off”, the mode selected last is set.

### **Note**

- The mode excluding the monochrome image display area is “Custom” mode.
  - The Brightness is the same as the value for the mode selected. To change the brightness, use the mode selected for adjustment.
-



● **To set the detection type in the monochrome image display area <Detection Type>**

You can set the detection type in the monochrome image display area.

**Attention**

- When the detection type is changed, the display area is highlighted for 5 seconds even if <Highlighted Area> is “Off”.

**Adjustable range**

Off, Type-1, Type-2, Type-3

**Procedure**

1. Choose <Color> from the Adjustment menu, and press ENTER.
2. Choose <Detection Type> from <Color>, and press ENTER.
3. Use ▲ or ▼ for adjustment.
4. Press ENTER to exit.

Detection Type	Purpose
Type-1	Select when the layout of the color and monochrome images on the screen is complicated.
Type-2	Select for a simple screen on which the monochrome images can be identified easily.
Type-3	Select when a color image with a color difference exists in the monochrome image displayed area.

● **To set the highlight area in the monochrome display area <Highlight Area>**

You can set On/Off for the highlight area in the monochrome image display area.

**Procedure**

1. Choose <Color> from the Adjustment menu, and press ENTER.
2. Choose <Highlight Area> from <Color>, and press ENTER.
3. Select “On” or “Off” with ▲ or ▼.
4. Press ENTER to exit.

## 2-3. Screen Size Selection

### ● To change screen size <Screen Size>

The image with the resolution other than the recommended resolution is displayed in full screen automatically. You can change the screen size by using the <Screen Size> function from <Screen>.

Setting	Function
Full	Displays an image in full screen. Images are distorted in some cases because the vertical rate is not equal to the horizontal rate.
Enlarged	Displays an image in full screen. In some cases, a blank horizontal or vertical border appears to equalize the vertical rate and the horizontal rate.
Normal	Displays images with the specified resolution.

Example: Image size  $1280 \times 1024$

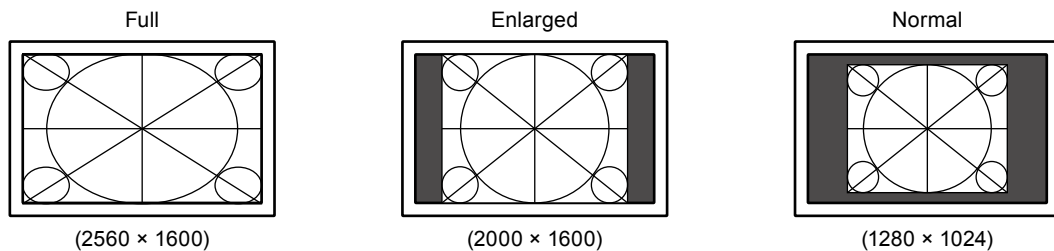

### Procedure

1. Choose <Screen> from the Adjustment menu, and press ENTER.
2. Choose <Screen Size> from <Screen>, and press ENTER.
3. Select “Full”, “Enlarged,” or “Normal” with ▲ or ▼.
4. Press ENTER to exit.

### Attention

- Selecting “Normal” may make some color gradations unavailable for display.

# Chapter 3 Setting Monitor

## 3-1. Enabling/Disabling Mode Selection <Mode Preset>

Allows you to select the specified modes only.

Use this function when all the display modes are not available or when keeping the display mode unchanged.

### **Procedure**

1. Choose <Tools> from the Adjustment menu, and press ENTER.
2. Choose <Mode Preset> from <Tools>, and press ENTER.
3. Use ▲ or ▼ to select the mode to change, and press ENTER.
4. Select “On” or “Off” with ▲ or ▼.
5. Press ENTER to exit.

---

### **Attention**

- You cannot set all the modes disable. Set at least one mode to “On”
- 

## 3-2. Setting Language <Language>

This function allows you to select a language for the Adjustment menu and messages.

### **Selectable languages**

English/German/French/Spanish/Italian/Swedish/Japanese/Simplified Chinese/Traditional Chinese

### **Procedure**

1. Choose <Menu Settings> from the Adjustment menu, and press ENTER.
2. Choose <Language> from <Menu Settings>, and press ENTER.
3. Select a language with ▲ or ▼.
4. Press ENTER to exit.

## 3-3. Setting Adjustment Menu Display

### ● **Changing Adjustment Menu Display Position <Menu Position>**

You can change the display position of the Adjustment menu.

### **Procedure**

1. Choose <Menu Settings> from the Adjustment menu, and press ENTER.
2. Choose <Menu Position> from <Menu Settings>, and press ENTER.
3. Choose the position with ▲ or ▼.
4. Press ENTER to exit.

## 3-4. Setting the EIZO Logo Display <Logo>

This function allows you to display, or not, the EIZO logo.

### Procedure

1. Press  $\mathcal{O}$  to turn off the monitor.
2. Holding MODE down, press  $\mathcal{O}$  for at least two seconds to turn on the monitor.  
The Optional Settings menu appears.
3. Choose <Logo> from <Optional Settings>, and press ENTER.
4. Select "On" or "Off" with  $\blacktriangle$  or  $\blacktriangledown$ , and press ENTER.
5. Select "Finish" with  $\blacktriangle$  or  $\blacktriangledown$ .
6. Press ENTER.  
The Optional Settings menu is closed.

## 3-5. Locking Buttons <Key Lock>

This function allows you to lock the adjusted/set status to prevent changing them.

### Procedure

1. Press  $\mathcal{O}$  to turn off the monitor.
2. Holding MODE down, press  $\mathcal{O}$  for at least two seconds to turn on the monitor.  
The Optional Settings menu appears.
3. Choose <Key Lock> from <Optional Settings>, and press ENTER.
4. Choose "Off", "Menu", or "All" with  $\blacktriangle$  or  $\blacktriangledown$ , and press ENTER.

Settings	Buttons that can be locked
OFF (Default setting)	None (All buttons are enabled)
Menu	ENTER button
All	All buttons excluding $\mathcal{O}$

5. Select "Finish" with  $\blacktriangle$  or  $\blacktriangledown$ .
6. Press ENTER.  
The Optional Settings menu is closed.

## 3-6. Enabling/Disabling DDC communication

This function allows you to enable/disable the DDC communication. (This is different from the DDC/CI communication.)

### Procedure

1. Press  $\mathcal{O}$  to turn off the monitor.
2. Holding MODE down, press  $\mathcal{O}$  for at least two seconds to turn on the monitor.  
The Optional Settings menu appears.
3. Choose <DDC> from <Optional Settings>, and press ENTER.
4. Select "On" or "Off" with  $\blacktriangle$  or  $\blacktriangledown$ , and press ENTER.
5. Select "Finish" with  $\blacktriangle$  or  $\blacktriangledown$ .
6. Press ENTER.  
The Optional Settings menu is closed.

## 3-7. Enabling/Disabling DC5V output

---

This function allows you to enable/disable the DC5V output.

### Procedure

1. Press **⏻** to turn off the monitor.
2. Holding **MODE** down, press **⏻** for at least two seconds to turn on the monitor.  
The Optional Settings menu appears.
3. Choose <DC5V Output> from <Optional Settings>, and press **ENTER**.
4. Select "On" or "Off" with **▲** or **▼**, and press **ENTER**.
5. Select "Finish" with **▲** or **▼**.
6. Press **ENTER**.  
The Optional Settings menu is closed.

## 3-8. Setting the Input Signals <Signal Selection>

---

Signals can be selected based on your operating environment (DVI signal input).

### Attention

- A supported graphics board is required to display.
  - Refer to the manual of the graphics board.
- 

### Procedure

1. Press **⏻** to turn off the monitor.
2. Holding **MODE** down, press **⏻** for at least two seconds to turn on the monitor.  
The Optional Settings menu appears.
3. Choose <Signal Selection> from <Optional Settings>, and press **ENTER**.
4. Select "Dual Link" or "Single Link" with **▲** or **▼** and press **ENTER**.
5. Select "Finish" with **▲** or **▼**.
6. Press **ENTER**.  
The Optional Settings menu is closed.

## 3-9. Return To Default Setting

---

There are two different Resets: Color Reset for only resetting the color adjustments to the default settings and All Reset for resetting all settings to the defaults.

---

**Attention**

- After resetting, you cannot undo the operation.

---

**Note**

- Regarding the default setting, see “[Main Default Settings](#)” (page 37).
- 

### ● To reset the color adjustment value <Color Reset>

This function only resets the color adjustment value for the currently selected mode to the default settings.

**Procedure**

1. Choose <Color> from the Adjustment menu, and press ENTER.
2. Choose <Color Reset> from <Color>, and press ENTER.
3. Choose “Execute” with ▲ or ▼.
4. Press ENTER.

The color adjustments revert to the default settings.

### ● To reset all adjustments to the default settings <All Reset>

This function resets all adjustments to the default settings (except the <Input> and <Optional Settings> menus).

**Procedure**

1. Choose <Tools> from the Adjustment menu, and press ENTER.
2. Choose <All Reset> from <Tools>, and press ENTER.
3. Select “Execute” with ▲ or ▼.
4. Press ENTER.

All settings excluding the <Input> and <Optional Settings> menus are reset to the default settings.

# Chapter 4 Controlling Monitor Quality

This product has the built-in Integrated Front Sensor, which allows the user to perform periodic calibration and Grayscale Check for the monitor independently.

---

**Note**

- To perform advanced quality control that conforms to medical standards, use the optional monitor quality control software kit “RadiCS UX1”.
  - “RadiCS UX1” allows you to set the adjustment target and schedule for the calibration and Grayscale Check.
  - The supplied “RadiCS LE” software also allows you to set the adjustment target and schedule for the calibration. For details, refer to RadiCS LE User’s Manual on the CD-ROM.
- 

## 4-1. Executing Calibration <SelfCalibration>

---

This function allows you to execute SelfCalibration and view the latest result. In addition, when the schedule is set using RadiCS/RadiCS LE, the next calibration schedule appears.

### ● Executing SelfCalibration

**Procedure**

1. Choose <RadiCS SelfQC> from the Adjustment menu, and press ENTER.
2. Choose <SelfCalibration> from <RadiCS SelfQC>, and press ENTER.
3. Select “Execute” with ▲ or ▼.
4. Press ENTER to exit.  
SelfCalibration is executed.

### ● Viewing SelfCalibration result

---

**Attention**

- The result can be viewed when “QC History” is “On”.
- 

**Procedure**

1. Choose <RadiCS SelfQC> from the Adjustment menu, and press ENTER.
2. Choose <SelfCalibration> from <RadiCS SelfQC>, and press ENTER.
3. Select “Result” with ▲ or ▼.
4. Select “DICOM”, “Custom”, “CAL1”, “CAL2” or “CAL3” with ▲ or ▼.
5. Press ENTER to exit.  
The SelfCalibration result (Max. Error Rate, Last Time, and Error Code) appears.

## 4-2. Checking Grayscale <Grayscale Check>

This function allows you to execute Grayscale Check and view the latest result. In addition, when the schedule is set using RadiCS, the next grayscale check schedule appears.

### ● Executing Grayscale Check

#### **Procedure**

1. Choose <RadiCS SelfQC> from the Adjustment menu, and press ENTER.
2. Choose <Grayscale Check> from <RadiCS SelfQC>, and press ENTER.
3. Select “Execute” with ▲ or ▼.
4. Press ENTER to exit.

Grayscale Check is executed.

### ● Viewing Grayscale Check result

---

#### **Attention**

- The result can be viewed when “QC History” is “On”.
- 

#### **Procedure**

1. Choose <RadiCS SelfQC> from the Adjustment menu, and press ENTER.
2. Choose <Grayscale Check> from <RadiCS SelfQC>, and press ENTER.
3. Select “Result” with ▲ or ▼.
4. Select “DICOM”, “Custom”, “CAL1”, “CAL2” or “CAL3” with ▲ or ▼.
5. Press ENTER to exit.

Up to the five latest Grayscale Check results (Passed/Failed/Canceled/ERR) appear.

## 4-3. Setting On/Off for Warning and QC History <Settings>

This function allows you to set On/Off for Warning and QC History when the Grayscale Check result is Failed.

#### **Procedure**

1. Choose <RadiCS SelfQC> from the Adjustment menu, and press ENTER.
2. Choose <Settings> from <RadiCS SelfQC>, and press ENTER.
3. Select “Warning” or “QC History” with ▲ or ▼.
4. Select “On” or “Off” with ▲ or ▼.
5. Press ENTER to exit.



# Chapter 5 Power Saving Functions

## 5-1. Setting Power Saving <Power Save>

This function allows you to set the monitor into the power saving mode according to the PC status. When the monitor has shifted to the power saving mode, the images on the screen are not displayed.

### Attention

- Turning off the main power switch or unplugging the power cord completely shuts off power supply to the monitor.
- Devices connected to the USB upstream port and USB downstream port work when the monitor is in power saving mode or when the power button of the monitor is Off. Therefore, power consumption of the monitor varies with connected devices even in the power saving mode.
- Five seconds before the monitor enters the power saving mode, it displays a preliminary message.

### Procedure

1. Choose <PowerManager> from the Adjustment menu, and press ENTER.
2. Choose <Power Save> from <PowerManager>, and press ENTER.
3. Select “Off” and either “High” or “Low” with ▲ or ▼.  
High: Turns off the backlight. The power saving effect is the greatest.  
Low: Turns down the backlight to the lowest setting. The time until the operation stabilizes after exiting the power saving mode next time can be reduced.
4. Press ENTER to exit.

### Power Saving System

#### At DVI signal input

This monitor complies with the “DVI DMPM” standard.

#### At DisplayPort signal input

This monitor complies with the “DisplayPort Standard V1.1a”.

The monitor enters the power saving mode after five seconds in connection with the PC setting.

PC	Monitor	Power Indicator
ON	Operating	Green
Power saving mode	Power saving mode	Orange

## 5-2. Setting Power Indicator <Power Indicator>

The brightness of the power indicator (green) when the screen is displayed can be adjusted (default setting is set to light up when power is turned on, and brightness is set to 4).

### Procedure

1. Choose <PowerManager> from the Adjustment menu, and press ENTER.
2. Choose <Power Indicator> from <PowerManager>, and press ENTER.
3. Select the indicator brightness “Off” or in the range from 1 to 7 with ▲ or ▼ as desired.
4. Press ENTER to exit.

## 5-3. Setting the power saving mode when a person leaves the monitor <Presence Sensor>

The sensor on the front side of the monitor detects the movement of a person by setting a value from “Level-1” to “Level-4” of the Presence Sensor function. When a person moves away from the monitor, it shifts to the power saving mode automatically and does not display the images on the screen to reduce the power consumption. When a person comes near the monitor again, it comes back from the power saving mode and displays the images. The detection level of the Presence Sensor can be changed according to the environment of usage.

---

**Note**

- At the time of shifting to Power Saving mode, the message that indicates shifting is displayed.

---

**Attention**

- This function cannot be used during portrait style installation or <RadiCS SelfQC> execution.
- 

**Procedure**

1. Choose <PowerManager> from the Adjustment menu, and press ENTER.
2. Choose <Presence Sensor> from <PowerManager>, and press ENTER.
3. Select “Off” and any of “Level-1”, “Level-2”, “Level-3”, or “Level-4” (sensor detection level) with ▲ or ▼.
4. Press ENTER to exit.

Level	Detection Area	Details
Level-1	90 cm (35.4 inch) or less	If the user leaves the detection area, the monitor shifts to the power saving mode. Still objects in the detection area will be interpreted as present user. This setting is recommended if the monitor frequently shifts to the power saving, even though a user is in front of the screen.
Level-2	70 cm (27.6 inch) or less	
Level-3	Automatic setting (90 cm [35.4 inch] or less)	The detection area is defined automatically by the user’s movement. If the user leaves this area, the monitor shifts to the power saving mode. Still objects in the detection area will be ignored.
Level-4	Automatic setting (70 cm [27.6 inch] or less)	

# Chapter 6 Troubleshooting

If a problem still remains after applying the suggested remedies, contact your local dealer.

## No picture

Problem	Possible cause and remedy
<b>1. No picture</b> <ul style="list-style-type: none"> <li>Power indicator does not light.</li> </ul>	<ul style="list-style-type: none"> <li>Check whether the power cord is connected properly.</li> <li>Turn off the main power, and then turn it on again a few minutes later.</li> <li>Turn the main power switch on.</li> <li>Press .</li> </ul>
<ul style="list-style-type: none"> <li>Power indicator is lighting green.</li> </ul>	<ul style="list-style-type: none"> <li>Increase &lt;Brightness&gt;, &lt;Contrast&gt;, and/or &lt;Gain&gt; in the Adjustment menu (see <a href="#">“To perform advanced adjustments”</a> (page 12)).</li> </ul>
<ul style="list-style-type: none"> <li>Power indicator is lighting orange.</li> </ul>	<ul style="list-style-type: none"> <li>Switch the input signal (see <a href="#">“To switch among input signals &lt;Input&gt;”</a> (page 32)).</li> <li>Operate the mouse or keyboard.</li> <li>Check whether the PC is turned on.</li> <li>When the Presence Sensor is set at a value from “Level-1” to “Level-4”, the monitor may have shifted to the power saving mode. Come near to the monitor.</li> </ul>
<ul style="list-style-type: none"> <li>Power indicator flashes orange and green.</li> </ul>	<ul style="list-style-type: none"> <li>There is a problem in the device that uses DisplayPort connection. Solve the problem, turn off the monitor, and then turn it on again. Refer to the user’s manual of the device that uses DisplayPort connection for details.</li> </ul>
<b>2. The message below appears.</b> <ul style="list-style-type: none"> <li>This message appears when no signal is input. Example:</li> </ul> <div data-bbox="320 1263 715 1518" data-label="Image"> </div>	<p>This message appears when the signal is not input correctly even when the monitor functions properly.</p> <ul style="list-style-type: none"> <li>The message shown left may appear, because some PCs do not output the signal soon after power-on.</li> <li>Check whether the PC is turned on.</li> <li>Check whether the signal cable is connected properly.</li> <li>Switch the input signal (see <a href="#">“To switch among input signals &lt;Input&gt;”</a> (page 32)).</li> </ul>

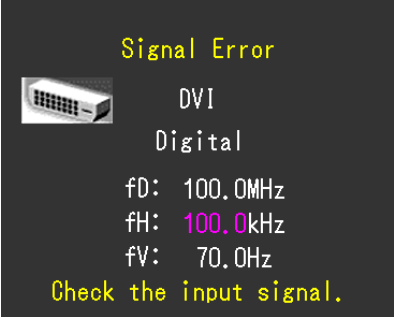
Problem	Possible cause and remedy
<ul style="list-style-type: none"> <li>The message shows that the input signal is out of the specified frequency range. (Such signal frequency is displayed in magenta.)</li> </ul> <p>Example:</p>  <p>fD: Dot clock fH: Horizontal scan frequency fV: Vertical scan frequency</p>	<ul style="list-style-type: none"> <li>Check whether the PC is configured to meet the resolution and vertical scan frequency requirements of the monitor (see “Compatible Resolutions” in the Setup Manual.).</li> <li>Reboot the PC.</li> <li>Select an appropriate display mode using the graphics board’s utility. Refer to the manual of the graphics board for details.</li> </ul>

## Imaging problems

Problem	Possible cause and remedy
<p><b>3. The screen is too bright or too dark.</b></p>	<ul style="list-style-type: none"> <li>Use &lt;Brightness&gt; or &lt;Contrast&gt; in the Adjustment menu to adjust it. (The LCD monitor backlight has a limited life span. When the screen becomes dark or begins to flicker, contact your local dealer.)</li> </ul>
<p><b>4. Characters are blurred.</b></p>	<ul style="list-style-type: none"> <li>Check whether the PC is configured to meet the resolution and vertical scan frequency requirements of the monitor (see “Compatible Resolutions” in the Setup Manual.).</li> </ul>
<p><b>5. Afterimages appear.</b></p>	<ul style="list-style-type: none"> <li>Afterimages are particular to LCD monitors. Avoid displaying the same image for a long time.</li> <li>Use the screen saver or power save function to avoid displaying the same image for extended periods of time.</li> </ul>
<p><b>6. Green/red/blue/white dots or defective dots remain on the screen.</b></p>	<ul style="list-style-type: none"> <li>This is due to LCD panel characteristics and is not a failure.</li> </ul>
<p><b>7. Interference patterns or pressure marks remain on the screen.</b></p>	<ul style="list-style-type: none"> <li>Leave the monitor with a white or black screen. The symptom may disappear.</li> </ul>

## Other problems

Problem	Possible cause and remedy
8. The adjustment menu does not appear.	<ul style="list-style-type: none"> <li>Check whether the operation lock function works (see “3-5. Locking Buttons &lt;Key Lock&gt;” (page 20)).</li> </ul>
9. No mode menu is displayed.	<ul style="list-style-type: none"> <li>Check whether the operation lock function works (see “3-5. Locking Buttons &lt;Key Lock&gt;” (page 20)).</li> </ul>
10. (When using Presence Sensor) The images remains to be displayed when you move away from the monitor. The images does not reappear when you come near it.	<ul style="list-style-type: none"> <li>Check the setting environment of the monitor. Presence Sensor may not work correctly in the following environments. <ul style="list-style-type: none"> <li>- There is something that reflects the light such as mirror or glass in front of the sensor.</li> <li>- The monitor is located in a place that receive direct sunlight.</li> <li>- There is some infrared device near the monitor.</li> <li>- There is some obstacle in front of the sensor.</li> </ul> </li> <li>Check whether any dirt on the sensor. Clean the sensor with a soft cloth.</li> <li>Check whether you are in front of the monitor. The infrared ray is emitted vertically from the sensor to detect a person.</li> </ul>
11. The monitor connected with the USB cable is not detected. / USB devices connected to the monitor does not work.	<ul style="list-style-type: none"> <li>Check whether the USB cable is connected correctly (see “7-3. Making Use of USB (Universal Serial Bus)” (page 34)).</li> <li>Change the USB port to another one. If the PC or peripheral devices works correctly by changing the USB port, contact your local dealer. (Refer to the manual of the PC for details.)</li> <li>Reboot the PC.</li> <li>If the peripheral devices work correctly when the PC and peripheral devices are connected directly, please contact your local dealer.</li> <li>Check whether the PC and OS are USB compliant. (For USB compliance of the respective devices, consult their manufacturers.)</li> <li>Check the PC’s BIOS setting for USB when using Windows. (Refer to the manual of the PC for details.)</li> </ul>
12. SelfCalibration/Grayscale Check failure	<ul style="list-style-type: none"> <li>SelfCalibration/Grayscale Check failed</li> <li>Refer to the error code table.</li> <li>If an error code that does not appear in the error code table is displayed, contact your local dealer.</li> </ul>

### Error Code table

Error Code	Details
0***	<ul style="list-style-type: none"> <li>Errors that occurred during SelfCalibration</li> </ul>
1***	<ul style="list-style-type: none"> <li>Errors that occurred during Grayscale Check</li> </ul>
*1**	<ul style="list-style-type: none"> <li>Errors that occurred during DICOM</li> </ul>
*2**	<ul style="list-style-type: none"> <li>Errors that occurred during Custom</li> </ul>
*3**	<ul style="list-style-type: none"> <li>Errors that occurred during CAL1</li> </ul>
*4**	<ul style="list-style-type: none"> <li>Errors that occurred during CAL2</li> </ul>
*5**	<ul style="list-style-type: none"> <li>Errors that occurred during CAL3</li> </ul>
**10	<ul style="list-style-type: none"> <li>The product maximum brightness may be lower than the target brightness.</li> <li>Lower the target brightness.</li> </ul>
**11	<ul style="list-style-type: none"> <li>The product minimum brightness may be higher than the target brightness.</li> <li>Raise the target brightness.</li> </ul>

Error Code	Details
**34	<ul style="list-style-type: none"> <li>• The sensor may not have worked correctly.</li> <li>• Turn off the main power, wait for a few minutes before turning the power back on, and then execute SelfCalibration/Grayscale Check again.</li> </ul>
**94	<ul style="list-style-type: none"> <li>• &lt;Screen Size&gt; is “Enlarged” or “Full”, and SelfCalibration or Grayscale Check cannot be executed.</li> <li>• Set &lt;Screen Size&gt; to “Normal”.</li> </ul>
**95	<ul style="list-style-type: none"> <li>• The execution conditions for SelfCalibration or Grayscale Check may not be appropriate.</li> <li>• Check the execution conditions and reset them if necessary.</li> </ul>

# Chapter 7 Reference

## 7-1. How to Attach the Optional Arm

An optional arm (or an optional stand) can be attached by removing the stand section. (The stand is not supplied with RX430-FC.)

### Attention

- When attaching an arm or stand, follow the instructions of their User's Manual.
- When using another manufacturer's arm or stand, confirm the following in advance and select one conforming to the VESA standard.
  - Clearance between the screw holes: 200 mm × 100 mm
  - Thickness of plate: 2.6 mm
  - Strong enough to support weight of the monitor unit (except the stand) and attachments such as cables.
- Use the screws as described below.
  - RX430/RX430-AR: The screws fixing the stand to the monitor and the screws supplied with this monitor.
  - RX430-FC: The screws supplied with this monitor (M4 × 12mm, 6 pcs.: black)
- When using an arm or stand, attach it to meet the following tilt angles of the monitor.
  - Up 45°, down 45°
- Connect the cables after attaching an arm or stand.
- Do not move the removed stand up and down. Doing so may result in injury or device damage.
- The monitor and arm or stand are heavy. Dropping them may result in injury or equipment damage.
- When setting the monitor to the portrait style, turn the monitor screen 90° in clockwise direction.

### Procedure

**1. Lay the LCD monitor on a soft cloth spread over on a stable surface with the panel surface facing down.**

**2. Remove the stand.**

Prepare a screwdriver. Loosen the screws (four) securing the unit and the stand with the screwdriver.

**3. Attach the arm or stand to the monitor.**

Secure the monitor to the arm or stand using the screws specified in the User's Manual of the arm or stand.

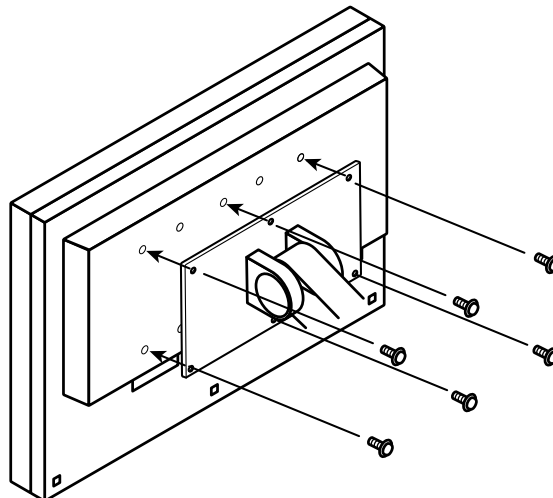

## 7-2. Connecting Multiple PCs

The product has multiple connections to PCs and allows you to switch to one of the connections for display.

### Connection examples

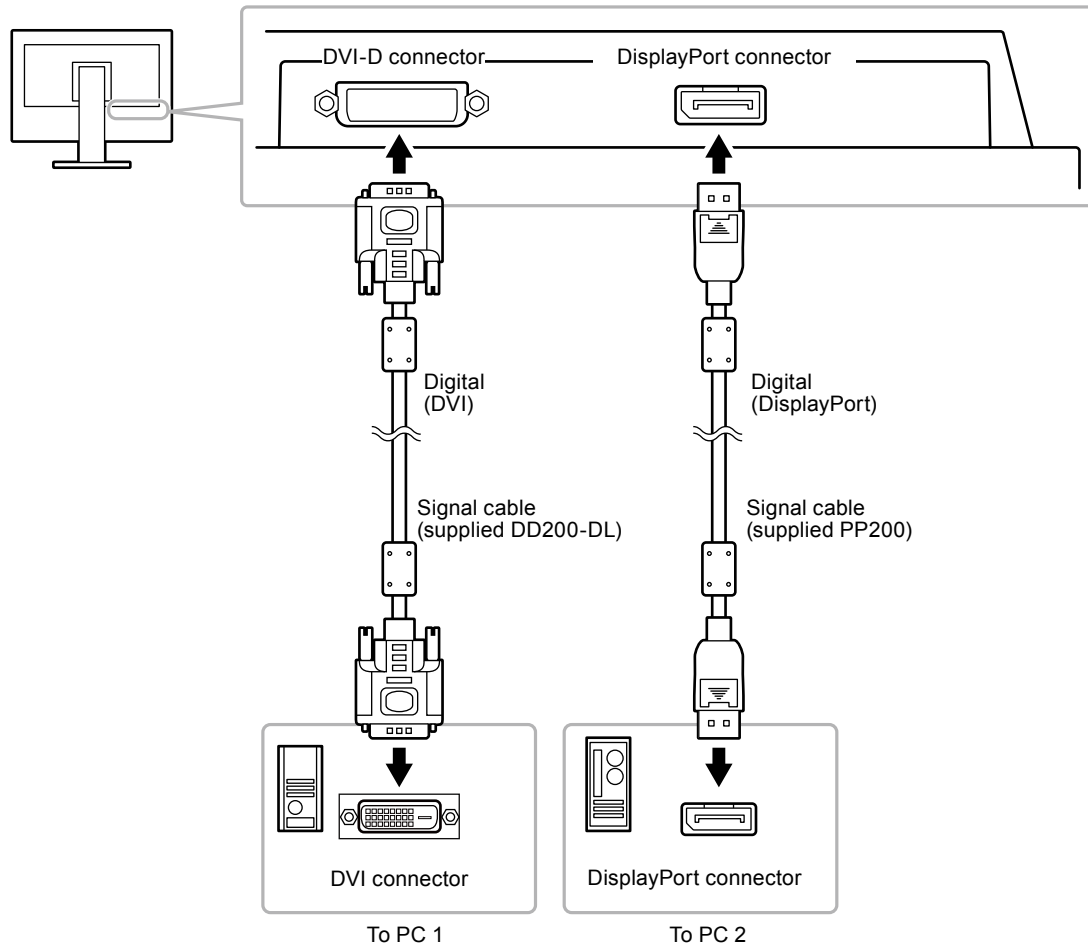

### ● To switch among input signals <Input>

#### Procedure

1. Choose <Tools> from the Adjustment menu, and press ENTER.
2. Choose <Input> from <Tools>, and press ENTER.
3. Select “DVI” or “DisplayPort” with ▲ or ▼.
4. Press ENTER to exit.

When the signal is switched, the active input port name appears at the top right corner of the screen.

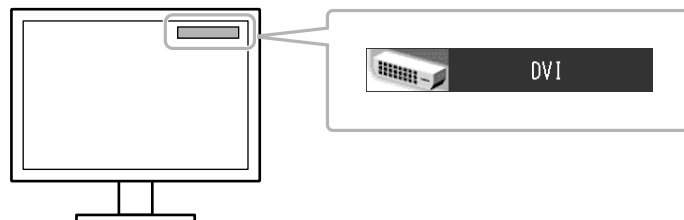



● To set input signal selection <Input Selection>

Setting	Function
Auto	The monitor recognizes the connector through which PC signals are input. When a PC is turned off or enters the powersaving mode, the monitor automatically displays another signal.
Manual	The monitor detects only the PC's signals currently displaying automatically. Select an active input signal with <Input>.

**Procedure**

1. Choose <Tools> from the Adjustment menu, and press ENTER.
2. Choose <Input Selection> from <Tools>, and press ENTER.
3. Select “Auto” or “Manual” with ▲ or ▼.
4. Press ENTER to exit.

---

**Note**

- When “Auto” is selected for <Input Selection>, the monitor's power saving function works only when all PCs are in the power saving mode.
-

## 7-3. Making Use of USB (Universal Serial Bus)

This monitor has a hub compatible with USB. Connected to a PC compatible with USB or another USB hub, this monitor functions as a USB hub allowing connection to peripheral USB devices.

### ● Required System Environment

1. A PC equipped with a USB port or another USB hub connected to a USB compatible PC
2. Windows 2000/XP/Vista/7 or Mac OS 9.2.2 and Mac OS X 10.2 or later
3. EIZO USB cable (MD-C93)

---

#### Attention

- This monitor may not work depending on PC, OS or peripheral devices to be used. For USB compatibility of peripheral devices, contact their manufactures.
  - Devices connected to the USB upstream port and USB downstream port work when the monitor is in power saving mode or when the power button of the monitor is Off. Therefore, power consumption of the monitor varies with connected devices even in the power saving mode.
  - When the main power switch is Off, device connected to the USB port will not operate.
- 

### ● Connection Procedure (Setup of USB Function)

1. Connect the monitor first to a PC using the signal cable, and run the PC.
2. Connect the supplied USB cable between the USB downstream port of a USB compatible PC (or another USB hub) and the monitor's USB upstream port.

The USB hub function is set up automatically upon connection of the USB cable.

3. Connect the peripheral USB device to the USB downstream port of the monitor.

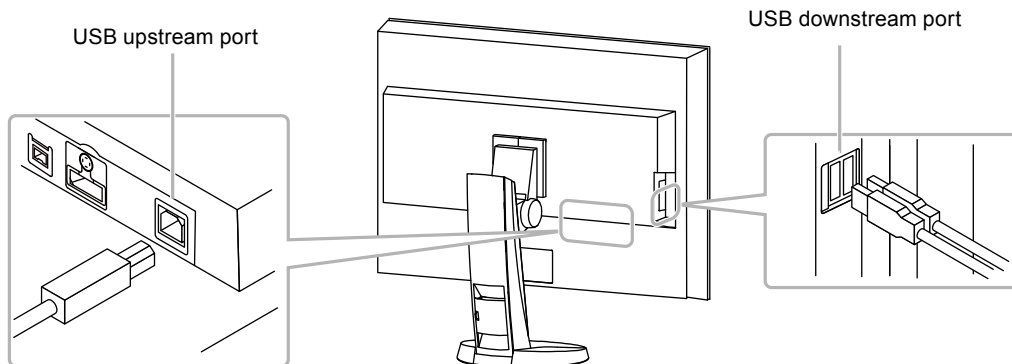

## 7-4. Displaying monitor information

### ● Displaying signal information <Signal Info>

This function displays the information about the current input signals displayed.

#### **Procedure**

1. Choose <Tools> from the Adjustment menu, and press ENTER.
2. Choose <Signal Info> from <Tools>, and press ENTER.

The Signal Info screen appears.

(Example)

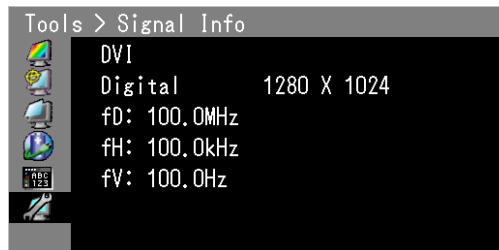

### ● Displaying Monitor Information <Monitor Info>

This function displays the information about the monitor.

#### **Procedure**

1. Choose <Tools> from the Adjustment menu, and press ENTER.
2. Choose <Monitor Info> from <Tools>, and press ENTER.

The Monitor Info screen appears.

This function allows you to display the model name, serial number, firmware version, and usage time.

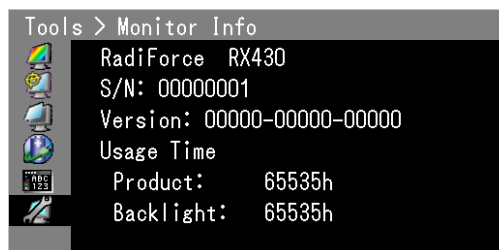

---

#### **Attention**

- The usage time is not always “0” when you purchase the monitor due to factory inspection.
-

## 7-5. Specifications

LCD Panel	Size	29.8-inch (756 mm) TFT color LCD	
	Surface treatment	RX430:	Anti-glare, hard coating
		RX430-AR:	Anti-reflection
		RX430-FC:	AR coating (both sides)
	Surface hardness	RX430:	2H
		RX430-AR:	2H
		RX430-FC:	3 H or more
	Visible reflectance	RX430-FC:	0.8% or less
Visible light transmittance	RX430-FC:	95% or more	
Viewing angles	Viewing angles: Horizontal 170°, vertical 170° (CR≥50)		
Dot pitch	0.2505 mm		
Response time	Black-white-black: Approx. 20 ms		
Horizontal scan frequency		31-100 kHz	
Vertical scan frequency		25.5-61 Hz (non-interlace)	
Resolution		2560 dots × 1600 lines	
Max. dot clock		290 MHz	
Max. display color		Approx. 1073.74 million colors (for DisplayPort 10 bit, DVI 10 bit input)	
Recommended brightness		400 cd/m <sup>2</sup> (approx. 35%) with color temperature of 6500K and 7500K	
Display area (H × V)		641.28 mm (25.5 inch) × 400.8 mm (16.1 inch)	
Power supply		100-120 Vac ±10%, 50/60 Hz 2.3-1.7A 200-240 Vac ±10%, 50/60 Hz 1.1-0.9A	
Power consumption	Screen display On	200 W or less (when a USB device is connected) 190 W or less (when no USB device is connected)	
	Power saving mode	1.0 W or less (when only the DVI signal connector is connected, no USB device is connected, <Input Selection> is set to "Manual", no 5 VDC output is connected, or <DC5V Output> is set to "Off")	
	Power Off	1.0 W or less (when no USB device is connected)	
	Main power Off	0 W	
Input signal connectors		DVI-D connector (Applicable to HDCP) DisplayPort (Standard V1.1a, applicable to HDCP)	
Digital Signal (DVI) Transmission System		TMDS (Single Link/Dual Link)	
DC5V Output		5.0V/1A	
Plug & Play		Digital (DVI-D) : VESA DDC 2B / EDID structure 1.3 Digital (DisplayPort) : VESA DisplayPort / EDID structure 1.4	
Dimensions (width) × (height) × (depth)	Main unit	720 mm (28.3 inch) × 496 - 661 mm (19.5 - 26 inch) × 348 - 281.5 mm (13.7 - 11.1 inch)	
	Main unit (without stand/RX430-FC)	720 mm (28.3 inch) × 498 mm (19.6 inch) × 119 mm (4.67 inch)	
Mass	Main unit	RX430/RX430-AR:	Approx. 19.2 kg (42.3 lbs.)
	Main unit (without stand)	RX430/RX430-AR:	Approx. 15.2 kg (33.5 lbs.)
		RX430-FC:	Approx. 16 kg (35.3 lbs.)
Movable range	FlexStand2	Tilt:	Up 25°, down 0°
		Swivel:	172° right, 172° left
		Adjustable height:	165 mm (Tilt: 25°), 114 mm (Tilt: 0°)

Environmental conditions	Temperature	Operating: 0°C to 35°C (32°F to 95°F) Storage: -20°C to 60°C (-4°F to 140°F)
	Humidity	Operating: 20% to 80% R.H. (no condensation) Storage: 10% to 80% R.H. (no condensation)
	Air pressure	Operating: 700 to 1,060 hPa Storage: 200 to 1,060 hPa
USB	Standard	USB Specification Revision 2.0
	Port	Upstream port × 1, Downstream port × 2
	Communication Speed	480 Mbps (high), 12 Mbps (full), 1.5 Mbps (low)
	Supply current	Downstream: Max. 500mA/1 port
Classification of Equipment		Type of protection against electric shock : Class I EMC class: EN60601-1-2:2007 Group 1 Class B Classification of medical device (MDD 93/42/EEC) : Class I

## Main Default Settings

**CAL Switch Mode : The default display mode setting is DICOM.**

Mode	Brightness	Temperature	Gamma value
DICOM	400 cd/m <sup>2</sup> (Approx. 35 %)	7,500K	DICOM
Custom	Approx. 400 cd/m <sup>2</sup> (35 %)	7,500K	2.2
CAL1	300 cd/m <sup>2</sup> (Approx. 25 %)	6,500K	DICOM
CAL2	300 cd/m <sup>2</sup> (Approx. 20 %)	6,500K	2.2
CAL3	400 cd/m <sup>2</sup> (Approx. 35 %)	7,500K	DICOM
sRGB	Approx. 250 cd/m <sup>2</sup> (0 %)	6,500K	2.2
Text	Approx. 100 cd/m <sup>2</sup> (50 %)	6,500K	2.2

## Others

Input*	DVI
Presence Sensor	Off
Power Save	High
Input Selection	Auto
Screen Size	Normal
Logo*	Off
DDC*	On
DC5V Output*	Off
Signal Selection*	Dual Link
Menu Position	Center
Language	English

\* These functions cannot be initialized with the <All Reset> function (see [page 22](#)).

## Outside Dimensions

unit : mm (inch)

### RX430/RX430-AR

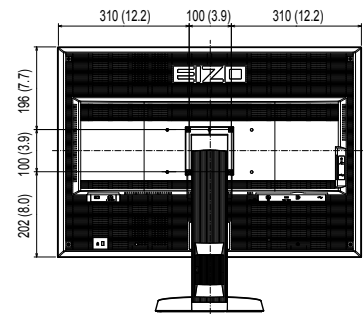
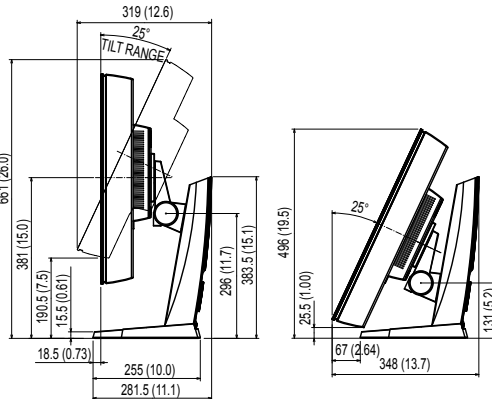
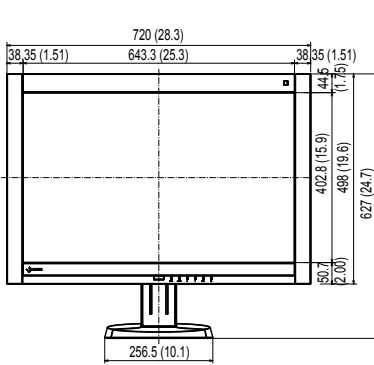
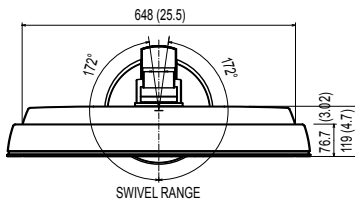

### RX430-FC

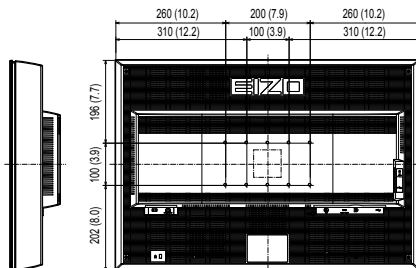
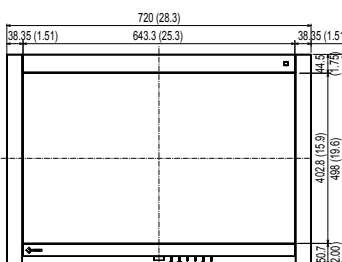
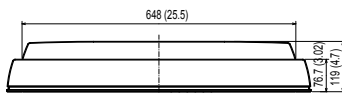

## Accessories

Calibration Kit	EIZO "RadiCS UX1" Ver. 3.6.0 or later EIZO "RadiCS Version Up Kit" Ver. 3.6.0 or later
Network QC Management Software	EIZO "RadiNET Pro" Ver. 3.6.0 or later EIZO "RadiNET Pro Lite" Ver. 3.6.0 or later
Cleaning Kit	EIZO "ScreenCleaner"

For the latest information about the accessories and information about the latest compatible graphics board, refer to our web site.

<http://www.radiforce.com>

## 7-6. Glossary

---

### **DDC (Display Data Channel)**

VESA provides the standardization for the interactive communication of the setting information, etc. between a PC and the monitor.

### **DICOM (Digital Imaging and Communication in Medicine)**

The DICOM standard was developed by the American College of Radiology and the National Electrical Manufacturer's Association of the USA.

The DICOM compatible device connection enables to transfer the medical image and information. The DICOM, Part 14 document defines the digital, grayscale medical image display.

### **DisplayPort**

VESA provides the digital interface standard for the digital display device. DisplayPort can transfer the video signal up to 16 bits for each channel of RGB, and the audio signal too. (This monitor supports the 8-bit or 10-bit video signals, but it does not support audio signals.)

### **DVI (Digital Visual Interface)**

DVI is a digital interface standard. DVI allows direct transmission of the PC's digital data without loss. This adopts the TMDS transmission system and DVI connectors. There are two types of DVI connectors. One is a DVI-D connector for digital signal input only. The other is a DVI-I connector for both digital and analog signal inputs.

### **DVI DMPM (DVI Digital Monitor Power Management)**

DVI DMPM is a digital interface power saving function. The "Monitor ON (operating mode)" and "Active Off (power saving mode)" are indispensable for DVI DMPM as the monitor's power mode.

### **Gain**

This is used to adjust each color parameter for red, green and blue. An LCD monitor displays the color by the light passing through the panel color filter. Red, green and blue are the three primary colors. All the colors on the screen are displayed by combining these three colors. The color tone can be changed by adjusting the light intensity (volume) passing through each color's filter.

### **Gamma**

Generally, the monitor brightness varies nonlinearly with the input signal level, which is called "Gamma Characteristic". A small gamma value produces a low-contrast image, while a large gamma value produces a high-contrast image.

## **HDCP (High-bandwidth Digital Content Protection)**

Digital signal coding system developed to copy-protect the digital contents, such as video, music, etc. This helps to transmit the digital contents safely by coding the digital contents sent via the DVI or HDMI connector on the output side and decoding them on the input side. Any digital contents cannot be reproduced if both of the equipments on the output and input sides are not applicable to HDCP system.

## **Resolution**

The LCD panel consists of numerous pixels of specified size, which are illuminated to form images. This monitor consists of horizontal 2560 pixels and 1600 vertical pixels. At a resolution of  $2560 \times 1600$ , all pixels are illuminated as a full screen (1:1).

## **sRGB (Standard RGB)**

International standard for color reproduction and color space among peripheral devices (such as monitors, printers, digital cameras, scanners). As a form of simple color matching for the Internet, colors can be displayed using tones close to those of the transmission and reception devices.

## **Temperature**

Color temperature is a method to measure the white color tone, generally indicated in degrees Kelvin. The screen becomes reddish at a low temperature, and bluish at a high temperature, like the flame temperature.

5000 K: Slightly reddish white

6500 K: White referred to as daylight-balanced color

9300 K: Slightly bluish white

## **TMDS (Transition Minimized Differential Signaling)**

A signal transmission system for digital interface.



# Appendix

## Trademark

The DisplayPort icon and VESA are trademarks and registered trademarks of the Video Electronics Standards Association in the United States and other countries.



Windows, Windows Vista, Windows Media, and Xbox 360 are registered trademarks of Microsoft Corporation in the United States and other countries.

Apple, Mac, Macintosh, iMac, eMac, Mac OS, MacBook, PowerBook, ColorSync, QuickTime, and iBook are registered trademarks of Apple Inc.

Acrobat, Adobe, Adobe AIR, and Photoshop are registered trademarks of Adobe Systems Incorporated in the United States and other countries.

PowerPC is a registered trademark of International Business Machines Corporation.

Pentium is a registered trademark of Intel Corporation in the United States and other countries.

AMD Athlon and AMD Opteron are trademarks of Advanced Micro Devices, Inc.

GRACoL and IDEAlliance are registered trademarks of International Digital Enterprise Alliance.

ColorVision, ColorVision Spyder2 are registered trademarks of DataColor Holding AG.

Spyder3 is a trademark of DataColor Holding AG.

Eye-One, ColorMunki, and X-Rite are registered trademarks or trademarks of X-Rite Incorporated.

TouchWare is a trademark of 3M Touch Systems, Inc.

NextWindow is a registered trademark of NextWindow Ltd.

RealPlayer is a registered trademark of RealNetworks, Inc.

NEC is a registered trademark of NEC Corporation. PC-9801 and PC-9821 are trademarks of NEC Corporation.

PlayStation is a registered trademark of Sony Computer Entertainment Inc.

PSP and PS3 are trademarks of Sony Computer Entertainment Inc.

EIZO, the EIZO Logo, ColorEdge, DuraVision, FlexScan, FORIS, RadiForce, RadiCS, RadiNET, and ScreenManager are registered trademarks of EIZO NANA O CORPORATION in Japan and other countries.

ColorNavigator, EIZO EasyPIX, EcoView NET, EIZO ScreenSlicer, i•Sound, Screen Administrator, UniColor Pro, and Raptor are trademarks of EIZO NANA O CORPORATION.

All other company and product names are trademarks or registered trademarks of their respective owners.

## License

The round gothic bold bit map font used for the characters displayed above this product is designed by Ricoh.

## Medical Standard

---

- It shall be assured that the final system is in compliance to IEC60601-1-1 requirement.
- Power supplied equipment can emit electromagnetic waves, that could influence, limit or result in malfunction of the monitor. Install the equipment in a controlled environment, where such effects are avoided.
- This is a monitor intended for use in a medical image system. It does not support the display of mammography images for diagnosis.

# FCC Declaration of Conformity

For U.S.A. , Canada, etc. (rated 100-120 Vac) Only

## FCC Declaration of Conformity

**We, the Responsible Party**

EIZO NANAOTECHNOLOGIES INC.

5710 Warland Drive, Cypress, CA 90630

Phone: (562) 431-5011

**declare that the product**

Trade name: EIZO

Model: RadiForce RX430

**is in conformity with Part 15 of the FCC Rules. Operation of this product is subject to the following two conditions: (1) this device may not cause harmful interference, and (2) this device must accept any interference received, including interference that may cause undesired operation.**

This equipment has been tested and found to comply with the limits for a Class B digital device, pursuant to Part 15 of the FCC Rules. These limits are designed to provide reasonable protection against harmful interference in a residential installation. This equipment generates, uses, and can radiate radio frequency energy and, if not installed and used in accordance with the instructions, may cause harmful interference to radio communications. However, there is no guarantee that interference will not occur in a particular installation. If this equipment does cause harmful interference to radio or television reception, which can be determined by turning the equipment off and on, the user is encouraged to try to correct the interference by one or more of the following measures.

- \* Reorient or relocate the receiving antenna.
- \* Increase the separation between the equipment and receiver.
- \* Connect the equipment into an outlet on a circuit different from that to which the receiver is connected.
- \* Consult the dealer or an experienced radio/TV technician for help.

Changes or modifications not expressly approved by the party responsible for compliance could void the user's authority to operate the equipment.

### Note

Use the attached specified cable below or EIZO signal cable with this monitor so as to keep interference within the limits of a Class B digital device.

- AC Cord
- Shielded Signal Cable (Enclosed)

## Canadian Notice

This Class B digital apparatus complies with Canadian ICES-003.

Cet appareil numérique de la classe B est conforme à la norme NMB-003 du Canada.

# EMC Information

Essential performance of RadiForce series is to display images and operate functions normally.



## CAUTION

The RadiForce series requires special precautions regarding EMC and need to be installed, put into service and used according to the following information.

Do not use any cables other than the cables that provided or specified by us.

Using other cables may cause the increase of emission or decrease of immunity.

Do not put any portable and mobile RF communications equipment close to the RadiForce series. Doing so may affect the RadiForce series.

The RadiForce series should not be used adjacent to or stacked with other equipment. If adjacent or stacked use is necessary, the equipment or system should be observed to verify normal operation in the configuration in which it will be used.

Anyone who connects additional equipment to the signal input part or signal output parts, configuring a medical system, is responsible that the system complies with the requirements of IEC/EN60601-1-2.

### Guidance and manufacturer's declaration - electromagnetic emissions

The RadiForce series is intended for use in the electromagnetic environment specified below.

The customer or the user of the RadiForce series should assure that it is used in such an environment.

Emission test	Compliance	Electromagnetic environment - guidance
RF emissions CISPR11/EN55011	Group 1	The RadiForce series uses RF energy only for its internal function. Therefore, its RF emission are very low and are not likely to cause any interference in nearby electronic equipment.
RF emissions CISPR11/EN55011	Class B	The RadiForce series is suitable for use in all establishments, including domestic establishments and those directly connected to the public low-voltage power supply network that supplies buildings used for domestic purposes.
Harmonic emissions IEC/EN61000-3-2	Class D	
Voltage fluctuations / flicker emissions IEC/EN61000-3-3	Complies	

### Guidance and manufacturer's declaration - electromagnetic immunity

The RadiForce series is intended for use in the electromagnetic environment specified below.

The customer or the user of the RadiForce series should assure that it is used in such an environment.

Immunity test	IEC/EN60601 test level	Compliance level	Electromagnetic environment - guidance
Electrostatic discharge (ESD) IEC/EN61000-4-2	±6kV contact ±8kV air	±6kV contact ±8kV air	Floors should be wood, concrete or ceramic tile. If floors are covered with synthetic material, the relative humidity should be at least 30%.
Electrical fast transient / burst IEC/EN61000-4-4	±2kV for power supply lines ±1kV for input/output lines	±2kV for power supply lines ±1kV for input/output lines	Mains power quality should be that of a typical commercial or hospital environment.
Surge IEC/EN61000-4-5	±1kV line(s) to line(s) ±2kV line(s) to earth	±1kV line(s) to line(s) ±2kV line(s) to earth	Mains power quality should be that of a typical commercial or hospital environment.
Voltage dips, short interruptions and voltage variations on power supply input lines IEC/EN61000-4-11	<5% $U_T$ (>95% dip in $U_T$ ) for 0.5 cycle 40% $U_T$ (60% dip in $U_T$ ) for 5 cycles 70% $U_T$ (30% dip in $U_T$ ) for 25 cycles <5% $U_T$ (>95% dip in $U_T$ ) for 5sec	<5% $U_T$ (>95% dip in $U_T$ ) for 0.5 cycle 40% $U_T$ (60% dip in $U_T$ ) for 5 cycles 70% $U_T$ (30% dip in $U_T$ ) for 25 cycles <5% $U_T$ (>95% dip in $U_T$ ) for 5sec	Mains power quality should be that of a typical commercial or hospital environment. If the user of the RadiForce series requires continued operation during power mains interruptions, it is recommended that the RadiForce series be powered from an uninterruptible power supply or a battery.
Power frequency (50/60Hz) magnetic field IEC/EN61000-4-8	3A/m	3A/m	Power frequency magnetic fields should be at levels characteristic of a typical location in a typical commercial or hospital environment.

NOTE  $U_T$  is the a.c. mains voltage prior to application of the test level.

**Guidance and manufacturer's declaration - electromagnetic immunity**

The RadiForce series is intended for use in the electromagnetic environment specified below. The customer or the user of the RadiForce series should assure that it is used in such an environment.

Immunity test	IEC/EN60601 test level	Compliance level	Electromagnetic environment - guidance
<p>Conducted RF IEC/EN61000-4-6</p> <p>Radiated RF IEC/EN61000-4-3</p>	<p>3Vrms 150kHz to 80MHz</p> <p>3V/m 80MHz to 2.5GHz</p>	<p>3Vrms</p> <p>3V/m</p>	<p>Portable and mobile RF communications equipment should be used no closer to any part of the RadiForce series, including cables, than the recommended separation distance calculated from the equation applicable to the frequency of the transmitter.</p> <p>Recommended Separation distance</p> $d = 1.2 \sqrt{P}$ <p><math>d = 1.2 \sqrt{P}</math>, 80MHz to 800MHz  <math>d = 2.3 \sqrt{P}</math>, 800MHz to 2.5GHz</p> <p>Where "P" is the maximum output power rating of the transmitter in watts (W) according to the transmitter manufacturer and "d" is the recommended separation distance in meters (m).</p> <p>Field strengths from fixed RF transmitters, as determined by an electromagnetic site survey<sup>a</sup>, should be less than the compliance level in each frequency range<sup>b</sup>.</p> <p>Interference may occur in the vicinity of equipment marked with the following symbol.</p> 

NOTE 1 At 80 MHz and 800 MHz, the higher frequency range applies.

NOTE 2 These guidelines may not apply in all situations. Electromagnetic propagation is affected by absorption and reflection from structures, objects and people.

<sup>a</sup> Field strengths from fixed transmitters, such as base stations for radio (cellular/cordless) telephones and land mobile radios, amateur radio, AM and FM radio broadcast and TV broadcast cannot be predicted theoretically with accuracy. To assess the electromagnetic environment due to fixed RF transmitters, an electromagnetic site survey should be considered. If the measured field strength in the location in which the RadiForce series is used exceeds the applicable RF compliance level above, the RadiForce series should be observed to verify normal operation. If abnormal performance is observed, additional measures may be necessary, such as reorienting or relocating the RadiForce series.

<sup>b</sup> Over the frequency range 150 kHz to 80 MHz, field strengths should be less than 3 V/m.

### Recommended separation distances between portable and mobile RF communications equipment and the RadiForce Series

The RadiForce series is intended for use in an electromagnetic environment in which radiated RF disturbances are controlled. The customer or the user of the RadiForce series can help prevent electromagnetic interference by maintaining a minimum distance between portable and mobile RF communications equipment (transmitters) and the RadiForce series as recommended below, according to the maximum output power of the communications equipment.

Rated maximum output power of transmitter  W	Separation distance according to frequency of transmitter m		
	150kHz to 80MHz $d = 1.2 \sqrt{P}$	80MHz to 800MHz $d = 1.2 \sqrt{P}$	800MHz to 2.5GHz $d = 2.3 \sqrt{P}$
0.01	0.12	0.12	0.23
0.1	0.38	0.38	0.73
1	1.2	1.2	2.3
10	3.8	3.8	7.3
100	12	12	23

For transmitters rated at a maximum output power not listed above, the recommended separation distance “d” in meters (m) can be estimated using the equation applicable to the frequency of the transmitter, where “P” is the maximum output power rating of the transmitter in watts (W) according to the transmitter manufacturer.

NOTE 1 At 80 MHz and 800 MHz, the separation distance for the higher frequency range applies.

NOTE 2 These guidelines may not apply in all situations. Electromagnetic propagation is affected by absorption and reflection from structures, objects and people.

Cable length		
Power Cord :	Accessory	2.0m
Signal Cable (DD200-DL) :	Accessory	2.0m
Signal Cable (PP200) :	Accessory	2.0m
USB Cable (MD-C93) :	Accessory	1.8m

# LIMITED WARRANTY

## LIMITED WARRANTY

EIZO NANA CORPORATION (hereinafter referred to as “EIZO”) and distributors authorized by EIZO (hereinafter referred to as the “Distributors”) warrant, subject to and in accordance with the terms of this limited warranty (hereinafter referred to as the “Warranty”), to the original purchaser (hereinafter referred to as the “Original Purchaser”) who purchased the product specified in this document (hereinafter referred to as the “Product”) from EIZO or Distributors, that EIZO and Distributors shall, at their sole discretion, either repair or replace the Product at no charge if the Original Purchaser becomes aware within the Warranty Period (defined below) that (i) the Product malfunctions or is damaged in the course of normal use of the Product in accordance with the description in the instruction manual attached to the Product (hereinafter referred to as the “User’s Manual”), or (ii) the LCD panel and brightness of the Product cannot maintain the recommended brightness specified in the User’s Manual in the course of normal use of the Product in accordance with the description of the User’s Manual.

The period of this Warranty is five (5) years from the date of purchase of the Product (hereinafter referred to as the “Warranty Period”), provided that the Warranty Period for the brightness is limited to five (5) years from the date of purchase of the Product subject to the usage time being less than or equal to 10,000 hours (the brightness is 400cd/m<sup>2</sup> and color temperature is 7500K) or less than or equal to 20,000 hours (the brightness is 300cd/m<sup>2</sup> and color temperature is 6500K). EIZO and Distributors shall bear no liability or obligation with regard to the Product in relation to the Original Purchaser or any third parties other than as provided under this Warranty.

EIZO and Distributors will cease to hold or store any parts of the Product upon expiration of seven (7) years after the production of such parts is discontinued. In repairing the monitor, EIZO and Distributors will use renewal parts which comply with our QC standards.

The Warranty is valid only in the countries or territories where the Distributors are located. The Warranty does not restrict any legal rights of the Original Purchaser.

Notwithstanding any other provision of this Warranty, EIZO and Distributors shall have no obligation under this Warranty whatsoever in any of the cases as set forth below:

- (a) Any defect of the Product caused by freight damage, modification, alteration, abuse, misuse, accident, incorrect installation, disaster, faulty maintenance and/or improper repair by third party other than EIZO and Distributors;
- (b) Any incompatibility of the Product due to possible technical innovations and/or regulations;
- (c) Any deterioration of the sensor;
- (d) Any deterioration of display performance caused by the deterioration of expendable parts such as the LCD panel and/or backlight, etc. (e.g. changes in brightness uniformity, changes in color, changes in color uniformity, defects in pixels including burnt pixels, etc.);
- (e) Any deterioration of the Product caused by the use at higher brightness than the recommended brightness described in the User’s Manual;
- (f) Any defect of the Product caused by external equipment;
- (g) Any defect of the Product on which the original serial number has been altered or removed;
- (h) Any normal deterioration of the product, particularly that of consumables, accessories, and/or attachments (e.g. buttons, rotating parts, cables, User’s Manual, etc.); and
- (i) Any deformation, discoloration, and/or warp of the exterior of the product including that of the surface of the LCD panel.

To obtain service under the Warranty, the Original Purchaser must deliver the Product, freight prepaid, in its original package or other adequate package affording an equal degree of protection, assuming the risk of damage and/or loss in transit, to the local Distributor. The Original Purchaser must present proof of purchase of the Product and the date of such purchase when requesting services under the Warranty.

The Warranty Period for any replaced and/or repaired product under this Warranty shall expire at the end of the original Warranty Period.

EIZO OR DISTRIBUTORS ARE NOT RESPONSIBLE FOR ANY DAMAGE TO, OR LOSS OF, DATA OR OTHER INFORMATION STORED IN ANY MEDIA OR ANY PART OF ANY PRODUCT RETURNED TO EIZO OR DISTRIBUTORS FOR REPAIR.

EIZO AND DISTRIBUTORS MAKE NO FURTHER WARRANTIES, EXPRESSED OR IMPLIED, WITH RESPECT TO THE PRODUCT AND ITS QUALITY, PERFORMANCE, MERCHANTABILITY OR FITNESS FOR ANY PARTICULAR USE. IN NO EVENT SHALL EIZO OR DISTRIBUTORS BE LIABLE FOR ANY INCIDENTAL, INDIRECT, SPECIAL, CONSEQUENTIAL OR OTHER DAMAGE WHATSOEVER (INCLUDING, WITHOUT LIMITATION, DAMAGES FOR LOSS OF PROFIT, BUSINESS INTERRUPTION, LOSS OF BUSINESS INFORMATION, OR ANY OTHER PECUNIARY LOSS) ARISING OUT OF THE USE OR INABILITY TO USE THE PRODUCT OR IN ANY CONNECTION WITH THE PRODUCT, WHETHER BASED ON CONTRACT, TORT, NEGLIGENCE, STRICT LIABILITY OR OTHERWISE, EVEN IF EIZO OR DISTRIBUTORS HAVE BEEN ADVISED OF THE POSSIBILITY OF SUCH DAMAGES. THIS EXCLUSION ALSO INCLUDES ANY LIABILITY WHICH MAY ARISE OUT OF THIRD PARTY CLAIMS AGAINST THE ORIGINAL PURCHASER. THE ESSENCE OF THIS PROVISION IS TO LIMIT THE POTENTIAL LIABILITY OF EIZO AND DISTRIBUTORS ARISING OUT OF THIS LIMITED WARRANTY AND/OR SALES.



## BEGRENZTE GARANTIE

EIZO NANA CORPORATION (im Weiteren als „EIZO“ bezeichnet) und die Vertragsimporteure von EIZO (im Weiteren als „Vertrieb(e)“ bezeichnet) garantieren dem ursprünglichen Käufer (im Weiteren als „Erstkäufer“ bezeichnet), der das in diesem Dokument vorgegebene Produkt (im Weiteren als „Produkt“ bezeichnet) von EIZO oder einem Vertrieb erworben hat, gemäß den Bedingungen dieser beschränkten Garantie (im Weiteren als „Garantie“ bezeichnet), dass EIZO und der Vertrieb nach eigenem Ermessen das Produkt entweder kostenlos reparieren oder austauschen, falls der Erstkäufer innerhalb der Garantiefrist (weiter unten festgelegt) entweder (i) eine Fehlfunktion bzw. Beschädigung des Produkts feststellt, die während des normalen Gebrauchs des Produkts gemäß den Anweisungen des zum Lieferumfang des Produkts gehörenden Benutzerhandbuchs (im Weiteren als „Benutzerhandbuch“ bezeichnet) aufgetreten ist, oder (ii) das LCD-Panel und die Helligkeit des Produkts während des normalen Gebrauchs des Produkts gemäß den Anweisungen des Benutzerhandbuchs nicht die im Benutzerhandbuch genannte empfohlene Helligkeit aufrecht erhalten können.

Die Dauer der Garantieleistung beträgt fünf (5) Jahre ab dem Kaufdatum des Produkts (im Weiteren als „Garantiefrist“ bezeichnet), dass die Garantiefrist für die Helligkeit auf fünf (5) Jahre ab dem Kaufdatum des Produkts beschränkt ist, wobei die Benutzungszeit des Produkts auf maximal 10.000 Betriebsstunden (bei einer Helligkeit von 400 cd/m<sup>2</sup> und Farbtemperatur 7500 K) oder maximal 20.000 Betriebsstunden (bei einer Helligkeit von 300 cd/m<sup>2</sup> und Farbtemperatur 6500 K) beschränkt ist. EIZO und die Vertriebe übernehmen über den Rahmen dieser Garantie hinaus hinsichtlich des Produkts keinerlei Haftung oder Verpflichtung dem Erstkäufer oder Dritten gegenüber.

EIZO und die Vertriebe verpflichten sich, Ersatzteile für das Produkt über einen Zeitraum von sieben (7) Jahren nach Einstellung der Produktion der Ersatzteile zu lagern bzw. anzubieten. EIZO und seine Vertriebspartner verpflichten sich, bei einer etwaigen Reparatur des Monitors ausschließlich Produkte gemäß den EIZO-Qualitätssicherungsstandards zu verwenden.

Diese Garantie gilt nur in Ländern oder Gebieten, in denen sich Vertriebe befinden. Die gesetzlichen Gewährleistungsrechte des Erstkäufers gegenüber dem Verkäufer werden durch diese Garantie nicht berührt.

EIZO und die Vertriebe besitzen im Rahmen dieser Garantie keinerlei Verpflichtung in den folgenden Fällen:

- (a) Produktdefekte, die auf Frachtschäden, Modifikation, Nachgestaltung, Missbrauch, Fehlbedienung, Unfälle, unsachgemäße Installation, Naturkatastrophen, fehlerhafte Wartung und/oder unsachgemäße Reparatur durch eine andere Partei als EIZO und die Vertriebe zurückzuführen sind.
- (b) Eine Inkompatibilität des Produkts aufgrund von technischen Neuerungen und/oder neuen Bestimmungen, die nach dem Kauf in Kraft treten.
- (c) Jegliche Verschlechterung des Sensors;
- (d) Jegliche Verschlechterung der Bildschirmleistung, die durch Verschleißteile wie den LCD-Panel und/oder die Hintergrundbeleuchtung usw. hervorgerufen werden (z.B. Veränderungen von Helligkeitsverteilung, Farben oder Farbverteilung, Pixeldefekte einschließlich ausgebrannter Pixel usw.).
- (e) Jegliche Abnutzung des Produkts, die auf einen Gebrauch mit einer höheren Helligkeit als die im Benutzerhandbuch genannte empfohlene Helligkeit zurückzuführen ist.
- (f) Produktdefekte, die durch externe Geräte verursacht werden.
- (g) Jeglicher Defekt eines Produkts, dessen ursprüngliche Seriennummer geändert oder entfernt wurde.
- (h) Normale Abnutzung des Produkts, insbesondere von Verbrauchsteilen, Zubehörteilen und/oder Beilagen (z.B. Tasten, drehbare Teile, Kabel, Benutzerhandbuch usw.); sowie
- (i) Verformungen, Verfärbungen und/oder Verziehungen am Produktäußeren, einschließlich der Oberfläche des LCD-Panels.

Bei Inanspruchnahme der Garantieleistung ist der Erstkäufer verpflichtet, das Produkt auf eigene Kosten und in der Originalverpackung bzw. einer anderen geeigneten Verpackung, die einen gleichwertigen Schutz gegen Transportschäden bietet, an den örtlichen Vertrieb zu übersenden, wobei der Erstkäufer das Transportrisiko gegenüber Schäden und/oder Verlust trägt. Zum Zeitpunkt der Inanspruchnahme der Garantieleistung muss der Erstkäufer einen Verkaufsbeleg vorweisen, auf dem das Kaufdatum angegeben ist.

Die Garantiefrist für ein im Rahmen dieser Garantie ausgetauschtes und/oder repariertes Produkt erlischt nach Ablauf der ursprünglichen Garantiefrist.

EIZO ODER DIE EIZO-VERTRAGSIMPORTEURE HAFTEN NICHT FÜR ZERSTÖRTE DATENBESTÄNDE ODER DIE KOSTEN DER WIEDERBESCHAFFUNG DIESER DATENBESTÄNDE AUF JEDLICHEN DATENTRÄGERN ODER TEILEN DES PRODUKTS, DIE IM RAHMEN DER GARANTIE BEI EIZO ODER DEN EIZO-VERTRAGSIMPORTEUREN ZUR REPARATUR EINGEREICHT WURDEN.

EIZO UND DIE EIZO-VERTRAGSIMPORTEURE GEBEN WEDER EXPLIZITE NOCH IMPLIZITE GARANTIE IN BEZUG AUF DIESES PRODUKT UND SEINE QUALITÄT, LEISTUNG, VERKÄUFLICHKEIT ODER EIGNUNG FÜR EINEN BESTIMMTEN ZWECK. AUF KEINEN FALL SIND EIZO ODER DIE EIZO-VERTRAGSIMPORTEURE VERANTWORTLICH FÜR JEDLICHE ZUFÄLLIGE, INDIREKTE, SPEZIELLE, FOLGE- ODER ANDERE SCHÄDEN JEDLICHER ART (EINSCHLIESSLICH OHNE JEDE BEGRENZUNG SCHÄDEN BEZÜGLICH PROFITVERLUST, GESCHÄFTSUNTERBRECHUNG, VERLUST VON GESCHÄFTSINFORMATION ODER JEDLICHE ANDEREN FINANZIELLEN EINBUSSEN), DIE DURCH DIE VERWENDUNG DES PRODUKTES ODER DIE UNFÄHIGKEIT ZUR VERWENDUNG DES PRODUKTES ODER IN JEDLICHER BEZIEHUNG MIT DEM PRODUKT, SEI ES BASIEREND AUF VERTRAG, SCHADENSERSATZ, NACHLAESSIGKEIT, STRIKTE HAFTPFLICHT ODER ANDEREN FORDERUNGEN ENTSTEHEN, AUCH WENN EIZO UND DIE EIZO-VERTRAGSIMPORTEURE IM VORAUS ÜBER DIE MÖGLICHKEIT SOLCHER SCHÄDEN INFORMIERT WURDEN. DIESER AUSSCHLUSS ENTHÄLT AUCH JEDE HAFTPFLICHT, DIE AUS FORDERUNGEN DRITTER GEGEN DEN ERSTKÄUFER ENTSTEHEN KANN. ZWECK DIESER KLAUSEL IST ES, DIE HAFTUNG VON EIZO UND DEN VERTRIEBEN GEGENÜBER FORDERUNGEN ZU BEGRENZEN, DIE AUS DIESER BESCHRÄNKTEN GARANTIE UND/ODER DEM VERKAUF ENTSTEHEN KÖNNEN.



## GARANTIE LIMITÉE

EIZO NANO CORPORATION (ci-après dénommé « **EIZO** ») et les distributeurs autorisés par EIZO (ci-après dénommés « **Distributeurs** »), sous réserve et conformément aux termes de cette garantie limitée (ci-après dénommée « **Garantie** »), garantissent à l'acheteur initial (ci-après dénommé « **Acheteur initial** ») du produit spécifié dans la présente (ci-après dénommé « **Produit** ») acheté auprès d'EIZO ou de Distributeurs agréés EIZO, que EIZO et ses Distributeurs auront pour option de réparer ou remplacer gratuitement le Produit si l'Acheteur initial constate, pendant la Période de garantie (définie ci-dessous), (i) qu'il y a un dysfonctionnement ou que le Produit a subi un dommage dans le cadre d'une utilisation normale du Produit conformément à la description du mode d'emploi qui accompagne le Produit (ci-après dénommé « **Manuel d'utilisateur** »), ou (ii) que le panneau LCD et la luminosité du Produit ne peuvent pas maintenir la luminosité recommandée spécifiée dans le Manuel d'utilisation dans le cadre d'une utilisation normale du Produit, conformément à la description du Manuel d'utilisation.

La période de cette Garantie est de cinq (5) ans à compter de la date d'achat du Produit (ci-après dénommée « Période de Garantie »), à condition que la Période de garantie concernant la luminosité soit limitée à cinq (5) ans à compter de la date d'achat du Produit sujet à une utilisation inférieure ou égale à 10 000 heures (la luminosité est de 400cd/m<sup>2</sup> et la température de la couleur à 7500K) ou inférieure ou égale à 20 000 heures (la luminosité est de 300cd/m<sup>2</sup> et la température de la couleur à 6500K). EIZO et ses Distributeurs déclinent toute responsabilité ou obligation concernant ce Produit face à l'Acheteur initial ou à toute autre personne à l'exception de celles stipulées dans la présente Garantie.

EIZO et ses Distributeurs cesseront de tenir ou conserver en stock toute pièce de ce Produit après l'expiration de la période de sept (7) ans suivant l'arrêt de la production de telles pièces. Pour réparer le moniteur, EIZO et ses distributeurs utiliseront des pièces de rechange conformes à nos normes de contrôle qualité.

La Garantie est valable uniquement dans les pays ou les territoires où se trouvent les Distributeurs. La Garantie ne limite aucun des droits reconnus par la loi à l'Acheteur initial.

Nonobstant toute autre clause de cette Garantie, EIZO et ses Distributeurs n'auront d'obligation dans le cadre de cette Garantie pour aucun des cas énumérés ci-dessous :

- (a) Tout défaut du Produit résultant de dommages occasionnés lors du transport, d'une modification, d'une altération, d'un abus, d'une mauvaise utilisation, d'un accident, d'une installation incorrecte, d'un désastre, d'un entretien et/ou d'une réparation incorrects effectués par une personne autre que EIZO ou ses Distributeurs ;
- (b) Toute incompatibilité du Produit résultant d'améliorations techniques et/ou réglementations possibles ;
- (c) Toute détérioration du capteur ;
- (d) Toute détérioration des performances d'affichage causée par la détérioration des éléments consommables tels que le panneau LCD et/ou le rétroéclairage, etc. (par exemple, des changements de l'uniformité de la luminosité, des changements de couleur, des changements de l'uniformité des couleurs, des défauts de pixels, y compris des pixels brûlés, etc.) ;
- (e) Toute détérioration du Produit causée par l'utilisation d'une luminosité plus élevée que la luminosité recommandée, telle que décrite dans le Manuel d'utilisation ;
- (f) Tout défaut du Produit causé par un appareil externe ;
- (g) Tout défaut d'un Produit sur lequel le numéro de série original a été altéré ou supprimé ;
- (h) Toute détérioration normale du Produit, particulièrement celle des consommables, des accessoires et/ou des pièces reliées au Produit (touches, éléments pivotants, câbles, Manuel d'utilisation etc.), et
- (i) Toute déformation, décoloration, et/ou gondolage de l'extérieur du Produit, y compris celle de la surface du panneau LCD.

Pour bénéficier d'un service dans le cadre de cette Garantie, l'Acheteur initial doit renvoyer le Produit port payé, dans son emballage d'origine ou tout autre emballage approprié offrant un degré de protection équivalent, au Distributeur local, et assumera la responsabilité des dommages et/ou perte possibles lors du transport. L'Acheteur initial doit présenter une preuve d'achat du Produit comprenant sa date d'achat pour bénéficier de ce service dans le cadre de la Garantie.

La Période de garantie pour tout Produit remplacé et/ou réparé dans le cadre de cette Garantie expirera à la fin de la Période de garantie initiale.

EIZO OU SES DISTRIBUTEURS NE SAURAIENT ÊTRE TENUS RESPONSABLES DES DOMMAGES OU PERTES DE DONNÉES OU D'AUTRES INFORMATIONS STOCKÉES DANS UN MÉDIA QUELCONQUE OU UNE AUTRE PARTIE DU PRODUIT RENVOYÉ À EIZO OU AUX DISTRIBUTEURS POUR RÉPARATION.

AUCUNE AUTRE GARANTIE, EXPLICITE OU TACITE, N'EST OFFERTE PAR EIZO ET SES DISTRIBUTEURS CONCERNANT LE PRODUIT ET SES QUALITÉS, PERFORMANCES, QUALITÉ MARCHANDE OU ADAPTATION À UN USAGE PARTICULIER. EN AUCUN CAS, EIZO OU SES DISTRIBUTEURS NE SERONT RESPONSABLES DES DOMMAGES FORTUITS, INDIRECTS, SPÉCIAUX, INDUITS, OU DE TOUT AUTRE DOMMAGE QUEL QU'IL SOIT (Y COMPRIS, SANS LIMITATION, LES DOMMAGES RÉSULTANT D'UNE PERTE DE PROFIT, D'UNE INTERRUPTION D'ACTIVITÉS, D'UNE PERTE DE DONNÉES COMMERCIALES, OU DE TOUT AUTRE MANQUE À GAGNER) RÉSULTANT DE L'UTILISATION OU DE L'INCAPACITÉ D'UTILISER LE PRODUIT OU AYANT UN RAPPORT QUELCONQUE AVEC LE PRODUIT, QUE CE SOIT SUR LA BASE D'UN CONTRAT, D'UN TORT, D'UNE NÉGLIGENCE, D'UNE RESPONSABILITÉ STRICTE OU AUTRE, MÊME SI EIZO OU SES DISTRIBUTEURS ONT ÉTÉ AVERTIS DE LA POSSIBILITÉ DE TELS DOMMAGES. CETTE LIMITATION INCLUT AUSSI TOUTE RESPONSABILITÉ QUI POURRAIT ÊTRE SOULEVÉE LORS DES RÉCLAMATIONS D'UN TIERS CONTRE L'ACHETEUR INITIAL. L'ESSENCE DE CETTE CLAUSE EST DE LIMITER LA RESPONSABILITÉ POTENTIELLE DE EIZO ET DE SES DISTRIBUTEURS RÉSULTANT DE CETTE GARANTIE LIMITÉE ET/OU DES VENTES.

## GARANTÍA LIMITADA

EIZO NANA CORPORATION (en lo sucesivo “EIZO”) y sus distribuidores autorizados por EIZO (en lo sucesivo los “Distribuidores”), con arreglo y de conformidad con los términos de esta garantía limitada (en lo sucesivo la “Garantía”), garantizan al comprador original (en lo sucesivo el “Comprador original”) que compró el producto especificado en este documento (en lo sucesivo el “Producto”) a EIZO o a sus Distribuidores, que EIZO y sus Distribuidores, a su propio criterio, repararán o sustituirán el Producto de forma gratuita si el Comprador original detecta dentro del periodo de la Garantía (indicado posteriormente) que: (i) el Producto no funciona correctamente o que se ha averiado durante el uso normal del mismo de acuerdo con las indicaciones del manual de instrucciones suministrado con el Producto (en lo sucesivo el “Manual del usuario”); o (ii) el panel LCD y el brillo del Producto no pueden mantener el brillo recomendado que se especifica en el Manual del usuario durante el uso normal del Producto de acuerdo con las descripciones del Manual del usuario.

El período de validez de esta Garantía es de cinco (5) años desde la fecha de compra del Producto (en adelante, “Período de garantía”), teniendo en cuenta que el Período de garantía del brillo del Producto está limitado a cinco (5) años a partir de la fecha de compra del Producto, siempre que el tiempo de uso sea inferior o igual a 10.000 horas (siendo el brillo de 400cd/m<sup>2</sup> y la temperatura de color de 7500K) o inferior o igual a 20.000 horas (siendo el brillo de 300cd/m<sup>2</sup> y la temperatura de color de 6500K). EIZO y sus Distribuidores no tendrán ninguna responsabilidad ni obligación con respecto al Producto para con el Comprador original ni con terceros que no sean las estipuladas en la presente Garantía.

EIZO y sus Distribuidores no estarán obligados a suministrar cualquier recambio del Producto una vez pasados siete (7) años desde que se deje de fabricar el mismo. Para la reparación del monitor, EIZO y los distribuidores utilizarán repuestos que cumplan con nuestros estándares de control de calidad.

La Garantía es válida sólo en los países y territorios donde están ubicados los Distribuidores. La Garantía no restringe ningún derecho legal del Comprador original.

A pesar de las estipulaciones de esta Garantía, EIZO y sus Distribuidores no tendrán obligación alguna bajo esta Garantía en ninguno de los casos expuestos a continuación:

- (a) Cualquier defecto del Producto causado por daños en el transporte, modificación, alteración, abuso, uso incorrecto, accidente, instalación incorrecta, desastre, mantenimiento incorrecto y/o reparación indebida realizada por un tercero que no sea EIZO o sus Distribuidores.
- (b) Cualquier incompatibilidad del Producto debida a posibles innovaciones técnicas y/o reglamentaciones.
- (c) Cualquier deterioro del sensor;
- (d) Cualquier deterioro en el rendimiento de la visualización causado por fallos en las piezas consumibles como el panel de cristal líquido y/o la luz de fondo, etc. (p.ej. cambios de uniformidad del brillo, cambios de color, cambios de uniformidad del color, defectos de píxeles, incluyendo píxeles muertos, etc.).
- (e) Cualquier deterioro del Producto causado por el uso continuado con un brillo superior al recomendado en el Manual del usuario.
- (f) Cualquier defecto del Producto causado por un equipo externo.
- (g) Cualquier defecto del Producto en el que haya sido alterado o borrado el número de serie original.
- (h) Cualquier deterioro normal del Producto, y en particular de las piezas consumibles, accesorios y demás (p. ej. botones, piezas giratorias, cables, Manual del usuario, etc.).
- (i) Cualquier deformación, decoloración y/o alabeo del exterior del Producto incluida la superficie del panel LCD.

Para obtener servicio en los términos de esta Garantía, el Producto deberá ser enviado por el Comprador original, a su Distribuidor local, con el transporte previamente pagado, en el embalaje original u otro embalaje adecuado que ofrezca el mismo grado de protección, asumiendo el riesgo de daños y/o pérdida del Producto durante el transporte. El Comprador original deberá presentar un comprobante de compra del Producto en el que se refleje la fecha de compra del mismo cuando lo solicite el servicio de Garantía.

El Período de garantía para cualquier Producto reemplazado y/o reparado en los términos de esta Garantía expirará al vencer el Período de garantía original.

EIZO O LOS DISTRIBUIDORES AUTORIZADOS DE EIZO NO SE RESPONSABILIZAN DE NINGÚN DAÑO O PÉRDIDA QUE PUEDAN SUFRIR LOS DATOS U OTRA INFORMACIÓN ALMACENADA EN CUALQUIER MEDIO O CUALQUIER PARTE DE CUALQUIER PRODUCTO DEVUELTO A EIZO O A LOS DISTRIBUIDORES DE EIZO PARA SU REPARACIÓN.

EIZO Y LOS DISTRIBUIDORES AUTORIZADOS DE EIZO NO OFRECEN NINGUNA OTRA GARANTÍA, IMPLÍCITA NI EXPLÍCITA, CON RESPECTO AL PRODUCTO Y A SU CALIDAD, RENDIMIENTO, COMERCIABILIDAD E IDONEIDAD PARA CUALQUIER USO EN PARTICULAR. EN NINGÚN CASO SERÁN EIZO O LOS DISTRIBUIDORES AUTORIZADOS DE EIZO RESPONSABLES DE NINGÚN DAÑO EMERGENTE, INDIRECTO, ESPECIAL, INHERENTE O CUALQUIERA QUE SEA (INCLUYENDO, SIN LIMITACIÓN, DAÑOS POR LUCRO CESANTE, INTERRUPCIÓN DE LA ACTIVIDAD COMERCIAL, PÉRDIDA DE INFORMACIÓN COMERCIAL O CUALQUIER OTRA PÉRDIDA PECUNIARIA) QUE SE DERIVE DEL USO O IMPOSIBILIDAD DE USO DEL PRODUCTO O EN RELACIÓN CON EL PRODUCTO, YA SEA BASADO EN CONTRATO, POR AGRAVIO, NEGLIGENCIA, ESTRICTA RESPONSABILIDAD O CUALQUIERA QUE SEA, AUN CUANDO SE HAYA ADVERTIDO A EIZO O A LOS DISTRIBUIDORES DE EIZO DE LA POSIBILIDAD DE TALES DAÑOS. ESTA EXCLUSIÓN TAMBIÉN ABARCA CUALQUIER RESPONSABILIDAD QUE PUEDA DERIVARSE DE RECLAMACIONES HECHAS POR UN TERCERO CONTRA EL COMPRADOR ORIGINAL. LA ESENCIA DE ESTA ESTIPULACIÓN ES LIMITAR LA RESPONSABILIDAD POTENCIAL DE EIZO Y LOS DISTRIBUIDORES QUE PUDIERA DERIVARSE DE ESTA GARANTÍA LIMITADA Y/O VENTAS.

## GARANZIA LIMITATA

EIZO NANO CORPORATION (a cui si farà riferimento da qui in poi con “EIZO”) ed i Distributori autorizzati da EIZO (a cui si farà riferimento da qui in poi con “Distributori”) garantiscono, secondo i termini di questa garanzia limitata (a cui si farà riferimento da qui in poi con “Garanzia”) all’acquirente originale (a cui si farà riferimento da qui in poi con “Acquirente originale”) che ha acquistato il prodotto specificato in questo documento (a cui si farà riferimento da qui in poi con “Prodotto”) da EIZO o dai suoi Distributori, che EIZO e i distributori, a loro discrezione, ripareranno o sostituiranno il Prodotto senza addebito se l’Acquirente originale trova, entro il periodo della Garanzia (definito sotto), che (i) il Prodotto malfunziona e si è danneggiato nel corso del suo normale utilizzo osservando le indicazioni del manuale di istruzioni allegato al Prodotto (a cui si farà riferimento da qui in poi con “Manuale utente”), o che (ii) il pannello LCD e la luminosità del Prodotto non possono mantenere la luminosità raccomandata specificata nel Manuale utente nel corso del normale utilizzo del Prodotto osservando le indicazioni del Manuale utente.

La presente Garanzia è limitata a cinque (5) anni dalla data di acquisto del prodotto (di qui in avanti “Periodo di Garanzia”), considerando che il Periodo di garanzia per la luminosità è limitato a cinque (5) anni dalla data di acquisto del Prodotto a condizione che il tempo di utilizzo sia inferiore o uguale a 10.000 ore (luminosità di 400cd/m<sup>2</sup> e il colore della temperatura di 7500K) o inferiore o uguale a 20.000 ore (luminosità di 300cd/m<sup>2</sup> e il colore della temperatura di 6500K). EIZO e i suoi Distributori non si assumono alcuna responsabilità e non hanno alcun obbligo riguardo al Prodotto verso l’Acquirente originale o terzi diversi da quelli relativi a questa Garanzia.

EIZO e i suoi Distributori cesseranno di tenere o di conservare qualsiasi ricambio del Prodotto allo scadere di sette (7) anni dopo che la produzione di tali ricambi è stata terminata. Per la riparazione del monitor, EIZO e i Distributori utilizzeranno parti di ricambio conformi ai nostri standard di controllo della qualità.

La Garanzia è valida soltanto nei paesi dove ci sono i Distributori EIZO. La Garanzia non limita alcun diritto legale dell’Acquirente originale.

Indipendentemente da qualsiasi altra condizione di questa Garanzia, EIZO e i suoi Distributori non avranno alcun obbligo derivante da questa Garanzia in ognuno dei casi elencati di seguito:

- (a) Qualsiasi difetto del Prodotto causato da danni di trasporto, modifiche, alterazioni, abusi, usi impropri, incidenti, installazione errata, calamità, manutenzione errata e/o riparazioni improprie eseguite da terze parti che non siano EIZO o i suoi Distributori.
- (b) Qualsiasi incompatibilità del Prodotto dovuta a possibili innovazioni tecniche e/o normative.
- (c) Qualsiasi deterioramento del sensore;
- (d) Qualsiasi deterioramento delle prestazioni dello schermo causato dal deterioramento delle parti consumabili, come il pannello LCD e/o la retroilluminazione, ecc. (per esempio: cambiamenti di uniformità della luminosità, cambiamenti di colore, cambiamenti di uniformità del colore, difetti dei pixel, inclusi i pixel bruciati, ecc.).
- (e) Qualsiasi deterioramento del Prodotto causato dal suo utilizzo ad una luminosità più alta di quella raccomandata nel Manuale utente.
- (f) Qualsiasi difetto del Prodotto causato da apparecchiature esterne.
- (g) Qualsiasi difetto del Prodotto in cui il numero di serie originale sia stato alterato o rimosso.
- (h) Qualsiasi normale deterioramento del Prodotto, in particolar modo nelle sue parti di consumo, accessori, e/o attacchi (per esempio: tasti, parti rotanti, cavi, Manuale dell’utente, ecc.).
- (i) Qualsiasi tipo di deformazione, scolorimento, e/o di involucro esterno del Prodotto inclusa la superficie del pannello LCD.

Per ricevere assistenza tecnica con questa Garanzia, l’Acquirente originale deve inviare il Prodotto, con trasporto pre-pagato, nella sua confezione originale o altra confezione adeguata che fornisce un livello analogo di protezione, assumendosi il rischio di danni e/o perdita in transito, al Distributore locale. L’Acquirente originale deve presentare la prova di acquisto che stabilisce la data di acquisto del Prodotto quando richiede servizio sotto Garanzia.

Il Periodo di garanzia per qualsiasi Prodotto sostituito e/o riparato sotto questa Garanzia scade alla fine del Periodo di garanzia originale.

EIZO O I SUOI DISTRIBUTORI NON SONO RESPONSABILI PER QUALSIASI DANNO O PERDITA DI DATI O ALTRE INFORMAZIONI MEMORIZZATI SU QUALSIASI SUPPORTO O QUALSIASI PARTE DI QUALSIASI PRODOTTO INVIATO A EIZO O I SUOI DISTRIBUTORI PER RIPARAZIONI.

EIZO E I SUOI DISTRIBUTORI NON OFFRONO ALCUNA GARANZIA ADDIZIONALE, IMPLICITA O ESPLICITA, RIGUARDO IL PRODOTTO E LA SUA QUALITÀ, PRESTAZIONI, VENDIBILITÀ O APPROPRIATEZZA PER QUALSIASI USO PARTICOLARE. IN NESSUN CASO EIZO O I DISTRIBUTORI EIZO AUTORIZZATI SARANNO RESPONSABILI PER QUALSIASI DANNO ACCIDENTALE, INDIRECTO, SPECIALE, CONSEGUENTE O DI QUALSIASI ALTRA NATURA (INCLUSI, SENZA LIMITI, DANNI PER PERDITA DI PROFITTI, INTERRUZIONE DELLE ATTIVITÀ, PERDITA DI INFORMAZIONI D’AFFARI O QUALSIASI ALTRA PERDITA PECUNIARIA) DERIVANTI DALL’USO O DALL’IMPOSSIBILITÀ DI USARE IL PRODOTTO O IN QUALSIASI RELAZIONE AL PRODOTTO, SIA SU BASE DI CONTRATTO, TORTO, NEGLIGENZA, STRETTA RESPONSABILITÀ O ALTRIMENTI, ANCHE SE EIZO O I DISTRIBUTORI EIZO AUTORIZZATI SONO STATI AVVERTITI DELLA POSSIBILITÀ DI TALI DANNI. QUESTA ESCLUSIONE INCLUDE ANCHE QUALSIASI RESPONSABILITÀ CHE POSSA INSORGERE DA RECLAMI DI TERZI CONTRO L’ACQUIRENTE ORIGINALE. L’ESSENZA DI QUESTO PROVVEDIMENTO È LIMITARE LA RESPONSABILITÀ POTENZIALE DI EIZO E DEI DISTRIBUTORI DERIVANTE DA QUESTA GARANZIA LIMITATA E/O DALLE VENDITE.

## BEGRÄNSAD GARANTI

EIZO NANO CORPORATION (nedan kallat "EIZO") och EIZOs auktoriserade distributörer (nedan kallade "Distributörer") garanterar i enlighet med villkoren i denna begränsade garanti (nedan kallad "Garantin") den ursprunglige köparen (nedan kallad den "Ursprunglige köparen") som köpte den i dokumentet specificerade produkten (nedan kallad "Produkten") från EIZO eller Distributörer, att EIZO eller Distributörer enligt eget gottfinnande kostnadsfritt antingen reparera eller byta ut den defekta Produkten om den Ursprunglige köparen inom Garantiperioden (definieras nedan) upptäcker att (i) Produkten fungerar felaktigt eller skadas under normal användning av Produkten i enlighet med beskrivningen i bruksanvisningen (nedan kallad "Bruksanvisning") eller att (ii) Produktens LCD-panel och ljusstyrka inte kan bibehålla den rekommenderade ljusstyrkan som anges i Bruksanvisningen under normal användning av Produkten i enlighet med beskrivningen i Bruksanvisningen.

Giltighetsperioden för denna garanti är fem (5) år från datumet för Produktens inköp (kallas här efter "Garantiperioden"), förutsatt att Garantiperioden för ljusstyrkan är begränsad till fem (5) år från produktens inköpsdatum såvida användningstiden är mindre än eller lika med 10 000 timmar (ljusstyrkan är 400cd/m<sup>2</sup> och färgtemperaturen är 7 500K) eller mindre än eller lika med 20 000 timmar (ljusstyrkan är 300cd/m<sup>2</sup> och färgtemperaturen är 6 500K). EIZO och Distributörer ska inte under några villkor ha något annat ansvar än vad som anges i denna garanti gällande Produkten i relation till den Ursprunglige köparen eller tredje part.

EIZO och Distributörer kommer att upphöra med lagerhållning av Produktens delar efter sju (7) år efter att produktionen av dessa delar upphört. Nät skärmen repareras använder EIZO och distributörer reservdelar som uppfyller våra kvalitetsstandarder.

Garantin är endast giltig i de länder där det finns Distributörer. Garantin begränsar inte några av den Ursprunglige köparens lagstadgade rättigheter.

Oavsett andra villkor i denna garanti ska inte EIZO Distributörer under några villkor ha något ansvar i något av de fall som beskrivs nedan:

- (a) När någon bristfällighet hos Produkten kan härledas till att ha uppstått vid frakt, modifiering, ändring, felaktigt handhavande, olycka, felaktig installation, katastrof, felaktigt underhåll och/eller felaktig reparation utförd av tredje part annan än EIZO och Distributörer.
- (b) Alla former av inkompatibilitet hos Produkten på grund av möjliga tekniska innovationer och/eller bestämmelser.
- (c) Alla försämringar av sensorn;
- (d) Alla försämringar av bildens prestanda beroende på förbrukningsdelar så som LCD-panel och/eller bakgrundsbelysning etc. (t.ex. ändringar i ljusstyrkans jämnhet, färg, färgjämnhet, defekta pixlar inklusive brända pixlar etc.).
- (e) Alla försämringar av Produkten orsakat av användning av en högre ljusstyrka än den i Bruksanvisningen rekommenderade ljusstyrkan.
- (f) Alla defekter hos Produkten som orsakats av extern utrustning.
- (g) Alla defekter hos Produkten på vilken det ursprungliga serienumret har ändrats eller avlägsnats.
- (h) All normal försämring av Produkten, speciellt förbrukningsartiklar, tillbehör och/eller yttre delar (t.ex. knappar, roterande delar, kablar, Bruksanvisningen etc.).
- (i) Varje deformation, missfärgning och/eller skevhet av Produktens yttre inklusive ytan på LCD-panelen.

För att erhålla service under denna garanti måste den Ursprunglige köparen (med hänseende till risken för skada och/eller förlust under transport) leverera Produkten till närmaste Distributör med förebetalad frakt, i dess ursprungliga förpackning eller annan fullgod förpackning som ger likvärdigt skydd. Den Ursprunglige köparen måste kunna visa inköpsbevis för Produkten som klargör Produktens inköpsdatum vid begäran av garantiservice.

Garantiperioden för alla utbytta och/eller reparerade produkter under denna garanti skall upphöra vid utgången av den ursprungliga Garantiperioden.

EIZO ELLER DISTRIBUTÖRER ÄR INTE ANSVARIGA FÖR NÅGON FORM AV SKADA ELLER FÖRLUST AV DATA ELLER ANNAN INFORMATION SOM HAR LAGRATS I NÅGON FORM AV MEDIA ELLER ANNAN DEL AV NÅGON PRODUKT SOM HAR RETURNERATS TILL EIZO ELLER DISTRIBUTÖRER FÖR REPARATION.

EIZO OCH DISTRIBUTÖRERNA GARANTERAR INGET, UTTRYCKLIGEN ELLER UNDERFÖRSTÅTT, VAD BETRÄFFAR PRODUKTEN OCH DESS KVALITET, PRESTANDA, SÄLJBARHET ELLER LÄMPLIGHET FÖR NÅGON FORM AV SPECIELL ANVÄNDNING. UNDER INGA OMSTÄNDIGHETER SKALL EIZO ELLER DISTRIBUTÖRERNA HÅLLAS ANSVARIGA FÖR NÅGRA SOM HELST UNDERORDNADE, INDIREKTA, SPECIELLA, DÄRAV FÖLJANDE ELLER ÖVRIGA SKADOR (INKLUSIVE, UTAN BEGRÄNSNING TILL, SKADOR FÖR FÖRLUST AV INKOMST, AVBRUTEN AFFÄRSRÖRELSE, FÖRLUST AV AFFÄRSINFORMATION ELLER ANNAN SÄRSKILD FÖRLUST) SOM UPPSTÅTT SOM ETT RESULTAT AV ANVÄNDNING ELLER OFÖRMÅGA ATT ANVÄNDA PRODUKTEN ELLER I NÅGON FORM AV ANSLUTNING TILL PRODUKTERNA, VARE SIG DETTA GRUNDAS PÅ KONTRAKT, ÅTALBAR HANDLING, FÖRSUMLIGHET, ANSVARSSKYLDIGHET ELLER ANNAT, ÄVEN OM EIZO ELLER DISTRIBUTÖRERNA HAR INFORMERATS BETRÄFFANDE MÖJLIGHET ATT SÅDANA SKADOR FÖRELIGGER. DETTA UNDANTAG OMFATTAR ÄVEN ALL FORM AV ANSVARSSKYLDIGHET SOM KAN UPPSTÅ GENOM EN TREDJE PARTS ANSPRÅK GENTEMOT DEN URSPRUNGLIGE KÖPAREN. GRUNDBESTÄNDSDELEN I BESTÄMMELEN ÄR ATT BEGRÄNSA DET EVENTUELLA ANSVARSTAGANDET FÖR EIZO OCH DISTRIBUTÖRERNA SOM KAN UPPSTÅ GENOM DENNA BEGRÄNSADE GARANTI OCH/ELLER FÖRSÄLJNING.



## 有限责任保证书

EIZO NANA O 有限公司（以下简称“EIZO”）和 EIZO 授权的经销商（以下简称“经销商”），接受并依照本有限责任保证书（以下简称“保证书”）之条款，向从 EIZO 和经销商购买本文中规定产品（以下简称“产品”）的原买方（以下称“原买方”）提供保证：在保证期内（规定如下），如果原买方发现 (i) 按本产品所附使用说明书（以下简称“用户手册”）所述方式正常使用本产品过程中，本产品出现故障或损坏 或 (ii) 按用户手册所述方式正常使用本产品过程中，本产品的液晶显示屏 (LCD) 及亮度未能达到用户手册中所述的推荐亮度时，EIZO 和经销商根据其各自的判断免费修理或更换该产品。

本保证期限定为自购买本产品之日起的五 (5) 年（以下简称“保证期限”），亮度的保证期限定为本产品的使用时间在 10000 小时以下 (含 10000 小时) (亮度为 400cd/m<sup>2</sup>，色温为开氏温度 7500) 或 20000 小时以下 (含 20000 小时) (亮度为 300cd/m<sup>2</sup>，色温为开氏温度 6500) 的条件下自购买本产品之日起五 (5) 年。EIZO 和经销商将不向原买方或任何第三方承担本保证书所规定之外的与本产品有关任何责任或义务。

本产品的任何部件停产七 (7) 年后，EIZO 和经销商将不再保留或保管任何这类部件。维修显示器时，EIZO 与经销商将使用符合我方质量控制标准的替换零件。

本保证书仅对于设有经销商的国家或地区有效。本保证书并不限定原买方的任何法律权利。

无论本保证书的任何其他条款如何规定，对于任何下列情况之一，EIZO 和经销商将不承担本保证书规定责任：

- (a) 由于运输损害、改装、改动、滥用、误用、意外事故、错误安装、灾害、维护不善和 / 或由除 EIZO 和经销商以外的第三方进行不适当的修理造成本产品的任何故障。
- (b) 由于可能发生的技术变更和 / 或调整造成本产品的任何不兼容性。
- (c) 传感器的任何劣化；
- (d) 由于诸如液晶显示屏 (LCD) 和 / 或背景照明等消耗品部件的老化造成的任何显示性能低劣（如亮度均一性变化、色彩变化、色彩均一性变化、包括烧伤像素在内的像素缺陷等）。
- (e) 由于在比用户手册所推荐亮度更高的亮度下使用对本产品所造成的任何老化。
- (f) 因外部设备造成本产品的任何故障。
- (g) 因本产品的原序号被改变或消除造成本产品的任何故障。
- (h) 本产品的任何正常老化，尤其是消耗品、附件和 / 或附加装置（如按钮、旋转部件、电缆、用户手册等）、以及
- (i) 本产品表面包括液晶显示屏 (LCD) 表面的任何变形、变色和 / 翘曲。

为了获得本保证书规定的服务，原买方必须使用原包装或其他具有同等保护程度的适当包装将本产品运送到当地的经销商，并且预付运费，承担运输中的损坏和 / 或损失的风险。要求提供本保证书规定的服务时，原买方必须提交购买本产品和标明此购买日期的证明。

按本保证书规定进行了更换和 / 或修理的任何产品的保证期限，将在原保证期限结束时终止。

在返回给 EIZO 和经销商进行修理后，任何产品的任何媒体或任何部件中储存的数据或其他信息发生任何损坏或损失，对此 EIZO 和经销商将不承担责任。

对于本产品及其质量、性能、可销售性以及对于特殊用途的适合性，EIZO 和经销商不提供其他任何明示或暗示的保证。因使用本产品或无法使用本产品或因与本产品有任何关系（无论是否根据合同）而造成：任何附带的、间接的、特殊的、随之发生的或其他的损害（包括但不限于 利润损失、业务中断、业务信息丢失或其他任何金钱损失）以及侵权行为、过失、严格赔偿责任或其他责任，即使已经向 EIZO 和经销商提出了发生这些损害的可能性，对此 EIZO 和经销商概不承担责任。本免责条款还包括因第三方向原买方提出索赔而可能发生的任何责任。本条款的本质是限定由于本有限责任保证书和 / 或销售本产品所发生的 EIZO 和经销商的潜在责任。

# China Measures for RoHS Compliance in ChinaRoHS

## 关于电子信息产品污染控制标识



本标识根据「电子信息产品污染控制管理办法」，适用于在中华人民共和国销售的电子信息产品。标识中央的数字为环保使用期限的年数。只要您遵守该产品相关的安全及使用注意事项，在自制造日起算的年限内，不会产生对环境污染或人体及财产的影响。上述标识粘贴在机器背面。

### • 有毒有害物质或元素的名称及含量

部件名称	有毒有害物质或元素					
	铅 (Pb)	汞 (Hg)	镉 (Cd)	六价铬 (Cr (VI))	多溴联苯 (PBB)	多溴二苯醚 (PBDE)
印刷电路板	×	○	○	○	○	○
机箱	○	○	○	○	○	○
液晶显示器	×	×	○	○	○	○
其他	×	○	○	○	○	○

○：表示该有毒有害物质在该部件所有均质材料中的含量均在 SJ/T 11363-2006 规定的限量要求以下。  
×：表示该有毒有害物质至少在该部件的某一均质材料中的含量超出 SJ/T 11363-2006 规定的限量要求。  
(企业可在此处，根据实际情况对上表中打“×”的技术原因进行进一步说明)



**EIZO NANA O CORPORATION**

153 Shimokashiwano, Hakusan, Ishikawa 924-8566 Japan  
Phone: +81 76 277 6792 Fax: +81 76 277 6793

**EIZO GmbH**

Siemensallee 84, 76187 Karlsruhe, Germany  
Phone: +49 721 20321 0 Fax: +49 721 20321 471

<http://www.radiforce.com>

2nd Edition-January, 2011

03V23405B1  
(U.M-RX430)