



INSTALLATION & OPERATION MANUAL

Versa Drawer™ Refrigeration Units



**Please read this manual completely
before attempting to install or operate
this equipment! Notify carrier of damage.
Inspect all components immediately.**

IMPORTANT WARNING AND SAFETY INFORMATION

Read this manual thoroughly before operating, installing, or performing maintenance on the equipment.

WARNING

FAILURE TO FOLLOW INSTRUCTIONS IN THIS MANUAL CAN CAUSE PROPERTY DAMAGE, INJURY OR DEATH.

DO NOT STORE OR USE GASOLINE OR OTHER FLAMMABLE VAPORS OR LIQUIDS IN THE VICINITY OF THIS OR ANY OTHER APPLIANCE.

UNLESS ALL COVER AND ACCESS PANELS ARE IN PLACE AND PROPERLY SECURED, DO NOT OPERATE THIS EQUIPMENT.

DAMP OR WET HANDS MAY STICK TO COLD SURFACES.

ALLOW HEATED EQUIPMENT TO COOL DOWN BEFORE ATTEMPTING TO CLEAN OR SERVICE.

DO NOT USE EXTENSION CORDS WITH THIS EQUIPMENT.

DO NOT USE ELECTRICAL APPLIANCES INSIDE THE FOOD STORAGE COMPARTMENTS OF THE APPLIANCE.

DO NOT USE MECHANICAL DEVICES OR OTHER MEANS TO ACCELERATE THE DEFROSTING PROCESS.

CAUTION

Observe the following:

- Keep the equipment area free and clear of combustible material.
- Maintain adequate clearance for air openings.
- Operate equipment only on the type of electricity indicated on the specification plate.
- Models 18682VDR-CE, 18682VDL-CE and F18VD82-CE did not pass the flicker test (IEC 61000-3-3). These models must not be connected to any electrical circuit with lights.

Table of Contents

SAFETY PRECAUTIONS	2
RECEIVING AND INSPECTING THE EQUIPMENT	4
SPECIFICATIONS	4
Serial Number	4
INSTALLATION	
Location	5
Inside Cabinet	5
Outside Cabinet	5
Leveling.....	5
Stabilizing.....	5
Plumbing	5
Electrical Connection	5
Refrigeration System	6
Temperature Monitoring	6
Controller	6
OPERATION	
Operating Controls.....	7
Setting the Drawer Mode.....	7
Setting Manual Defrost	7
MAINTENANCE	
General Maintenance	8
Stainless Steel Care and Cleaning	8
Cleaning the Condenser Coil	8
PREVENTIVE MAINTENANCE	
Gasket Maintenance	9
Drawer Maintenance	9
SCHEMATICS	10-14
VERSA DRAWER ALARM	15
STANDARD LABOR GUIDELINES TO REPAIR PARTS ON DELFIELD EQUIPMENT	16
STANDARD ONE-YEAR WARRANTY	17
SERVICE LABOR CONTRACT	18-19
ADDITIONAL FOUR-YEAR PROTECTION PLAN	20

RECEIVING AND INSPECTING THE EQUIPMENT

Even though most equipment is shipped crated, care should be taken during unloading so the equipment is not damaged while being moved into the building.

1. Visually inspect the exterior of the package and skid or container. Any damage should be noted and reported to the delivering carrier immediately.
2. If damaged, open and inspect contents with carrier.
3. In the event that the exterior is not damaged, yet upon opening, there is concealed damage to the equipment notify the carrier. Notification should be made verbally as well as in written form.

4. Request an inspection by the shipping company of the damaged equipment. This should be done within 10 days from receipt of the equipment.
5. Check the lower portion of the unit to be sure legs or casters are not bent.
6. Be sure to inspect the compressor compartment housing and visually inspect refrigeration package. Be sure lines are secure and base is still intact.
7. Freight carriers can supply the necessary damage forms upon request.
8. Retain all crating material until an inspection has been made or waived.

NOTE: This manual covers standard units only. If you have a custom unit, consult the technical service department.

SERIAL NUMBER

The serial number is located on the data plate mounted inside of Drawer 1. Always have the serial number of your unit available when calling for parts or service.

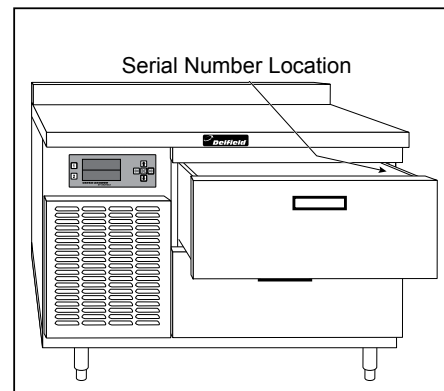

SPECIFICATIONS (115V/60Hz)

Freestanding Models												
Model	L	D	H	# of Drawers	Volts	HZ	Amps	HP	Plug	Ref. Charge	Ship Weight lbs.	
18650VDR	50" 127.0cm	31.5" 80.0cm	34" 86.4cm	2	115	60	6.0	1/3	5-15P	30oz.	520	
18650VDL	50" 127.0cm	31.5" 80.0cm	34" 86.4cm	2	115	60	6.0	1/3	5-15P	30oz.	520	
18682VDR	82" 208.3cm	31.5" 80.0cm	34" 86.4cm	4	115	60	12.0	(2) 1/3	5-15P	(2) 30oz.	720	
18682VDL	82" 208.3cm	31.5" 80.0cm	34" 86.4cm	4	115	60	12.0	(2) 1/3	5-15P	(2) 30oz.	720	
F2984VDR	84" 213.4cm	31.5" 80.0cm	26"	2	115	60	6.0	1/3	5-15P	30oz.	520	
F2984VDL	84" 213.4cm	31.5" 80.0cm	26"	2	115	60	6.0	1/3	5-15P	30oz.	520	
Component Crafted Models												
Model	L	D	H	# of Drawers	Volts	HZ	Amps	HP	Plug	Ref. Charge	Ship Weight lbs.	
F18VD50	50" 127.0cm	31.5" 80.0cm	36" 91.4cm	2	115	60	6.0	1/3	5-15P	30oz.	520	
F18VD82	82" 208.3cm	31.5" 80.0cm	36" 91.4cm	4	115	60	12.0	(2) 1/3	5-15P	(2) 30oz.	720	
F17VD84	84" 213.4cm	31.5" 80.0cm	36" 91.4cm	2	115	60	6.0	1/3	5-15P	30oz.	620	

SPECIFICATIONS (230-240V/50Hz)

Freestanding Models											
Model	L	D	H	# of Drawers	Volts	HZ	Amps	HP	Plug	Ref. Charge	Ship Weight
18650VDR-CE	50" 127.0cm	31.5" 80.0cm	34" 86.4cm	2	230-240	50	3.6	1/3	BS1373	850.5g	236kg
18650VDL-CE	50" 127.0cm	31.5" 80.0cm	34" 86.4cm	2	230-240	50	3.6	1/3	BS1373	850.5g	236kg
18682VDR-CE	82" 208.3cm	31.5" 80.0cm	34" 86.4cm	4	230-240	50	7.2	(2) 1/3	BS1373	(2) 850.5g	327kg
18682VDL-CE	82" 208.3cm	31.5" 80.0cm	34" 86.4cm	4	230-240	50	7.2	(2) 1/3	BS1373	(2) 850.5g	327kg
F2984VDR-CE	84" 213.4cm	31.5" 80.0cm	26" 66.0cm	2	230-240	50	3.6	1/3	BS1373	850.5g	236kg
F2984VDL-CE	84" 213.4cm	31.5" 80.0cm	26" 66.0cm	2	230-240	50	3.6	1/3	BS1373	850.5g	236kg
Component Crafted Models											
Model	L	D	H	# of Drawers	Volts	HZ	Amps	HP	Plug	Ref. Charge	Ship Weight
F18VD50-CE	50" 127.0cm	31.5" 80.0cm	36" 91.4cm	2	230-240	50	3.6	1/3	BS1373	850.5g	236kg
F18VD82-CE	82" 208.3cm	31.5" 80.0cm	36" 91.4cm	4	230-240	50	7.2	(2) 1/3	BS1373	(2) 850.5g	327kg
F17VD84-CE	84" 213.4cm	31.5" 80.0cm	36" 91.4cm	2	230-240	50	3.6	1/3	BS1373	850.5g	236kg

The plug for the above models must be accessible at all times or a switch must be provided in the fixed wiring in accordance with the wiring rules.

INSTALLATION

CAUTION

Never stand on the unit or its drawers! Doing so may result in bodily injury.

LOCATION

Units represented in this manual are intended for indoor use only. Be sure the location chosen has a floor strong enough to support the total weight of the cabinet and contents, which can be up to 1,200 pounds(550kg). Reinforce the floor as necessary to provide for maximum loading.

The location should be selected so that power cords can be connected without any extension cords.

For the most efficient operation, be sure to provide good air circulation inside and out. Avoid hot corners and locations near stoves and ovens.

CAUTION

Direct exposure to excessive amounts of steam in machine compartment will result in control board failure.

INSIDE CABINET

Do not pack drawer so full that air cannot circulate. Load product level with top of pans and keep all food covered.

OUTSIDE CABINET

The front louvers must be kept 24"(60cm) clear of any obstructions. Proper operation of these models is dependent on air being able to flow freely through the front louvers. Side louvers must have 24"(60cm) of clearance for service access.

CAUTION

Any restriction of the proper airflow outlined above, total or partial, will void the warranty on the unit.

LEVELING

The unit must be level so the drain pan will drain properly, drawers will line up with frames and the cabinet will not be subject to undue strain.

STABILIZING

All models are supplied with legs or casters installed for your convenience, for ease of cleaning underneath. The unit must be installed in a stable condition.

PLUMBING

All models are standard with a condensate evaporator pan.

ELECTRICAL CONNECTION

WARNING

ELECTRICAL CONNECTIONS AND GROUNDING CONNECTIONS MUST COMPLY WITH THE APPLICABLE PORTIONS OF THE NATIONAL ELECTRICAL CODE AND/OR OTHER LOCAL ELECTRICAL CODES.

WARNING

UNITS EQUIPPED WITH A FLEXIBLE ELECTRIC SUPPLY CORD ARE PROVIDED WITH A THREE-PRONG GROUNDING PLUG. THIS PLUG MUST BE CONNECTED INTO A PROPERLY GROUNDED THREE-PRONG RECEPTACLE. IF THE RECEPTACLE IS NOT THE PROPER GROUNDING TYPE, CONTACT AN ELECTRICIAN. DO NOT REMOVE THE GROUNDING PRONG FROM THIS PLUG.

A 7' (2.1 m) long grounded supply cord with three-pronged plug is provided with the standard units. Simply plug into a three-pronged wall outlet for proper grounding of the unit to begin operation.

Refer to the amperage data listed in the specifications, the serial number tag, your local code or the National Electrical Code to be sure the unit is connected to the proper power source. A protected circuit of the correct voltage and amperage must be installed for connection of the line cord or permanent connection to the unit.

Have the wall outlet checked by a qualified electrician to be sure a proper ground is present and that the outlet provides the correct voltage and required amperage to match the specifications. Do not use an adapter to connect to a two-pronged outlet. The three-pronged-outlet provides a ground connection that must be used to prevent a shock hazard.

Any power cord that is frayed or damaged should be replaced. When disconnecting the unit from the power source, do not pull on the cord. Firmly grip the plug and remove from outlet.

WARNING

The unit must be disconnected from the power source whenever performing service, maintenance functions or cleaning the refrigerated area.

OPERATION

GENERAL

Each drawer operates independently in one of four modes at any time:

Refrigerator mode The drawer operates at a set point of 37°F (3°C), maintaining a range between 34°F (1°C) and 40°F (4°C).

Freezer mode The drawer operates at a set point of -3°F (-19°C), maintaining a range between -6°F (-21°C) and 0°F (-17°C).

Thaw Cabinet mode The drawer maintains temperature between 36°F (2°C) and 41°F (5°C) for a minimum of 4 hours or longer if required. Once the thaw cycle is complete, the drawer mode is automatically changed to refrigerator mode.

Convenience Chiller mode The drawer operates as a chiller, maintaining the convenience chiller set point of 23°F (-5°C) for four hours. Once the convenience chiller cycle is complete, the drawer mode is changed to refrigerator mode.

Drawer gaskets are magnetic and mount to the drawer, snapping in place and are removable without tools.

REFRIGERATION SYSTEM

In a 4-drawer system there are two compressors; one operating drawers 1 and 2 and one operating drawers 3 and 4. In a 2-drawer system there is a single compressor.

TEMPERATURE MONITORING

Temperature sensors are located in each drawer. The drawer temperatures are displayed on the control panel.

CONTROL PANEL

The control panel provides information indicating the current mode of each individual drawer. In addition, the actual temperature of the drawer is displayed. See page 7 for control panel operation

DEFROST

An automatic defrost occurs every six hours in refrigerator and freezer mode.

Chiller product Info

Note: These results are based on chilling at a cabinet temperature of 5°F(-15°C) and 10 pounds(4.5kg) of product per drawer. The times are based on the duration to go from 140°F(60°C) to 40°F(4°C). The maximum limit of product to be chilled is no more than 10 pounds(4.5kg), not including pans. Product should be covered and no more than 2"(5cm) deep in the pan.

Internet Info

The Versa Drawer unit has the capability to be monitored remotely using the Internet. Using NAFEM protocol to monitor HACCP information such as cabinet and evaporator temperature as well as other key data can be view live or past data can be pulled up.



LAN line connection:



****Unplug unit before proceeding any further!**



Note: A user provided Ethernet cable is required

1. Disconnect power.
2. Remove access panel from end of machine compartment.
3. Thread Ethernet cable through hole in back of unit where power cable passes through. Connect to Ethernet port located on back of display board.
4. If necessary secure cable to prevent interference with condenser fan blades.
5. Connect other end of Ethernet cable to open port on store router/switch.
6. Attach access panel to end of unit.
7. Reconnect power to unit.
8. Contact Delfield service tech at 1-800-733-8829 with the following information:
 - Store Location
 - Mac Address (To obtain the MAC address. First, press the  button until "Program Menu" appears. Press  button until brackets are around "SW Version". Write down "Gateway Mac Address ## - ## - ## - ## - ##" displayed on screen. Press the  button twice to return to the main display screen.
 - After this information is received the Delfield service tech will inform you on Internet site access and a password to view your data.

Wireless connection:





Please contact Delfield for help with wireless connections.

Product	Chill Time
Mash Potatoes	3 hours 21 minutes
Scrambled Eggs	1 hour 53 minutes
Green Beans	2 hour 49 minutes
Soup (Vegetable)	2 hour 58
Spaghetti with Meat sauce	2 hours 32 minutes

OPERATION

OPERATING CONTROLS

All operating functions are accessible on the Versa Drawer control panel. Operators can select the drawer modes or activate the manual defrost. Access to all diagnostic functions require a qualified service technician.

CONTROL	FUNCTION
	Buttons are located next to the drawer display on the Control Panel. The drawer select buttons select the drawer to be configured.
	These arrows are used to change a drawer to operate in a desired mode (refrigerate, freezer, thaw or chill).
	Used to back up to the previous step.
	The i button is used to initiate the manual defrost mode.

Setting the drawer mode

Select the drawer mode as follows:

1. Press the button next to the drawer display to be changed.

NOTE: Current drawer mode text size will decrease.

2. Press the UP or DOWN arrow to select between refrigerate, freeze, chill or thaw until desired mode is reached.

3. Press the drawer display button again to lock the desired mode setting.

NOTE: Text size will return to original size.

Activating Manual Defrost

NOTE: The following two steps must be performed within 1 second.

1. Press the desired drawer display button.
2. Immediately press the  button.

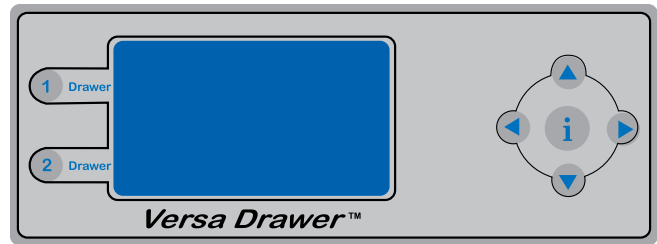



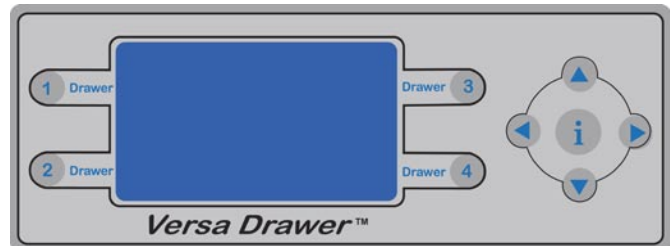

2-Drawer Interface Control





4-Drawer Interface Control

MAINTENANCE







Setting the Clock:

1. Press the  button until "Program Menu" appears.
2. Press the  button until brackets are around "Time & Date", then press .
3. Press   button to get to parameter to be adjusted.

NOTE: The [^] under the text show parameter to be adjusted.

4. Press the   buttons to adjust parameter.
5. Once correct time and date are set press the  button twice to return to the main display screen. (If no action is taken for 30 seconds control automatically returns to main display screen).

Fahrenheit to Celsius

1. Press the  button until "Service Menu" appears.
2. Press the  button until brackets are around "Configuration", then press .
3. Press  arrow to "System" and press .
4. In this menu will be "Metric", change to Yes.
5. Press  arrow until back to main menu.

 **WARNING**

THE UNIT MUST BE DISCONNECTED FROM THE POWER SOURCE WHENEVER PERFORMING SERVICE, MAINTENANCE FUNCTIONS OR CLEANING THE REFRIGERATED AREA.

GENERAL MAINTENANCE

Stainless Steel Care and Cleaning

To prevent discoloration or rust on stainless steel several important steps need to be taken. First, the properties of stainless steel need to be understood. Stainless steel contains 70-80% iron that will rust. It also contains 12-30% chromium that forms an invisible passive film over the steel's surface and acts as a shield against corrosion. As long as the protective layer is intact, the metal will not corrode, the metal is still stainless. If the film is broken or contaminated, outside elements can begin to break down the steel and begin to form rust or other discoloration.

 **CAUTION**

Never use steel pads, wire brushes or scrapers!

Do not use an abrasive cleaner because it will scratch the stainless steel and plastic and can damage the breaker strips and gaskets. Proper cleaning of stainless steel requires soft cloths or plastic scouring pads.

Cleaning solutions need to be alkaline based or non-chloride cleaners. Any cleaner containing chlorides will damage the protective film of the stainless steel. Chlorides are also commonly found in hard water, salts and household and industrial cleaners. If cleaners containing chlorides are used, be sure to rinse repeatedly and dry thoroughly upon completion.

Routine cleaning of the interior and exterior can be done with soap and warm water. Extreme stains or grease should be cleaned with a non-abrasive cleaner and plastic scrub pad. When cleaning the exterior, always rub with the grain of the stainless steel to avoid marring the finish. There are also stainless steel cleaners available which can restore and preserve the finish of the steels protective layer.

Early signs of stainless steel breakdown can consist of small pits and cracks. If this has begun, clean thoroughly and start to apply stainless steel cleaners in attempt to restore the passivity of the steel.

 **CAUTION**

Never use an acid based cleaning solution! Many food products have an acidic content that can deteriorate the finish. Be sure to clean ALL food products from any stainless steel surface. Common items include, tomatoes, peppers and other vegetables.

Cleaning the Condenser Coil

The condenser coil requires regular cleaning, recommended is every 90 days. In some instances you may find that there is a large amount of debris and dust or grease accumulated prior to the 90-day time frame. In these cases the condenser coil should be cleaned as needed.

If the build up on the coil consists of only light dust and debris the condenser coil can be cleaned with a simple brush. Heavier dust build up may require a vacuum or compressed air to blow through the condenser coil.

If heavy grease is present there are de-greasing agents available for refrigeration use and specifically for the condenser coils. The condenser coil may require a spray with the de-greasing agent and then blown through with compressed air.

Failure to maintain a clean condenser coil can initially cause high temperatures and excessive run times. Continuous operation with dirty or clogged condenser coils can result in compressor failures. Neglecting condenser coil cleaning procedures will void any warranties associated with the compressor or cost to replace the compressor.

 **CAUTION**

Never use a high-pressure water wash for this cleaning procedure as water can damage the electrical components located near or at the condenser coil.

If your freezer seems to vibrate excessively when the compressor is running, loosen (but do not remove) the bolts on the compressor. Semi hermetic models should be loosened before operating.

PREVENTIVE MAINTENANCE

Gasket Maintenance

Gaskets require regular cleaning to prevent mold and mildew build up and also to keep the elasticity of the gasket. Gasket cleaning can be done with the use of warm soapy water. Avoid full strength cleaning products on gaskets as this can cause them to become brittle and prevent proper seals. Also, never use sharp tools or knives to scrape or clean the gasket, which could possibly tear the gasket and rip the bellows.

Gaskets can easily be replaced and do not require the use of tools or authorized service persons. They can be pulled out of the groove in the door and new gaskets can be pressed back into place.

Drawer Maintenance

Drawer Assembly Cleaning

The drawer assembly is designed to be cleaned easily. Both drawer and tracks are removable without tools. The drawer tracks are dishwasher safe or can be cleaned in a sink with detergents and a soft bristle brush. Drawers and tracks should be cleaned on a weekly basis.

Remove Drawers

Pull the drawer box out until it stops. Lift up on the drawer front and pull the drawer box completely out. Using a soft bristle brush, clean the track on the bottom of the drawer box. When finished, it should be wiped clean of all food and debris.

Tracks

The drawer box assembly must be removed. Pull the drawer tracks out until they hit a stop. Locate blue safety clips towards the back of each drawer track. Blue safety clips have a tab on the top. Push the tab back until it clicks. Lift up and pull the drawer tracks all

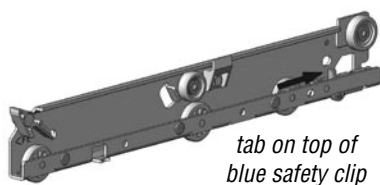

the way out of the drawer cage. The drawer tracks are dishwasher safe or can be cleaned in a sink with detergents and a soft bristle brush. Drawers and

tracks should be cleaned on a weekly basis. Using a soft bristle brush, wash the track making sure each roller is thoroughly cleaned. The drawer cage should be cleaned with a soft bristle brush, removing any food and debris gathered on the bottom ledge. Once it's cleaned thoroughly with a soft bristle brush, wipe remaining debris clean with a soft towel.

Reassembly

Push the drawer tracks into the drawer cage. The blue safety clip must remain pushed towards the back. Lift up and slide the drawer track all the way into the drawer cage. The blue safety clip will lock in place automatically. Once all tracks are replaced, insert the drawer box. Rest the drawer box bottom track on the front track roller. Then push the drawer back in place SLOWLY. When the drawer box is about half way in you will hit a STOP. You must lift the front of the drawer up approximately 1/2" (1.3cm) to continue inward. Clean tracks as often as possible. The cleaner the tracks are the better they will operate.

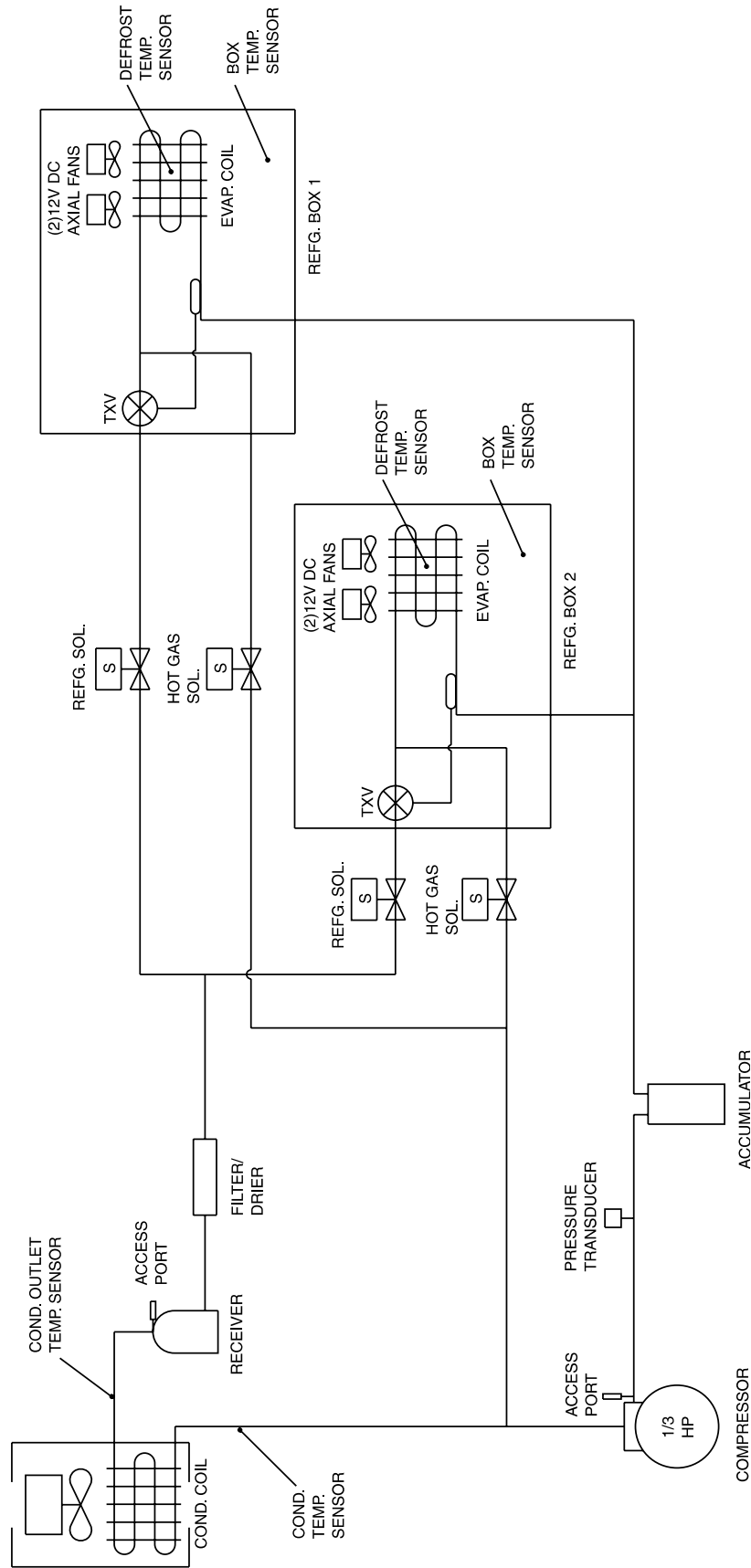

NOTE: The four drawer unit has two of these exact systems.

2-Drawer Refrigeration Schematic

2-Drawer Wiring Schematic

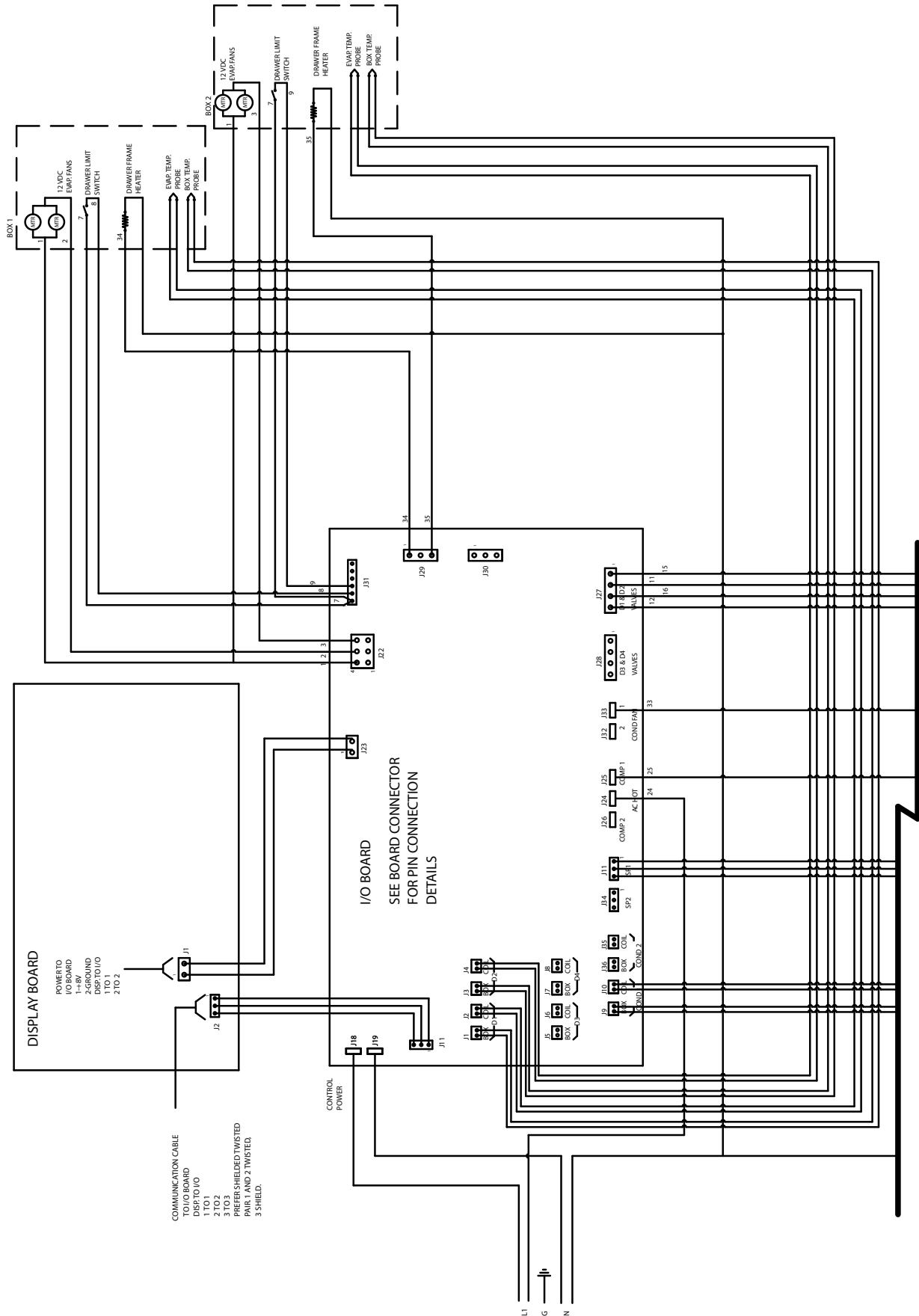

2-Drawer Wiring Schematic

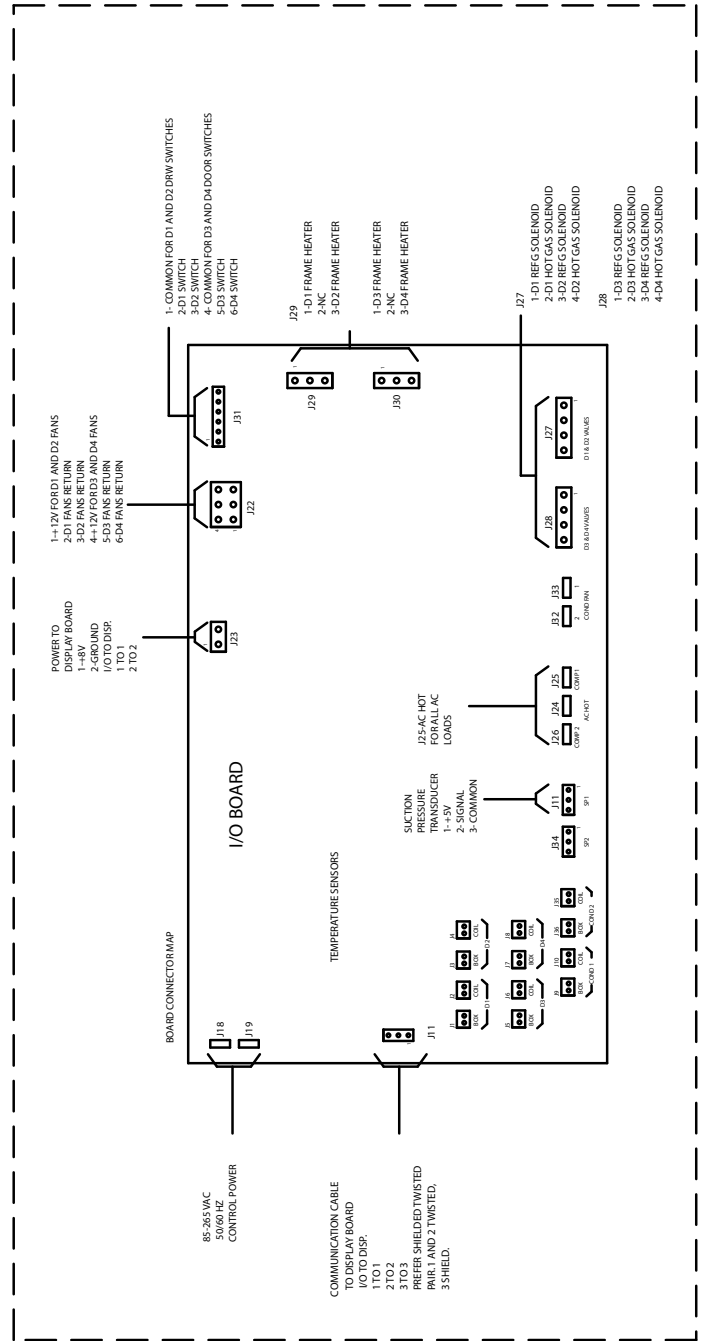
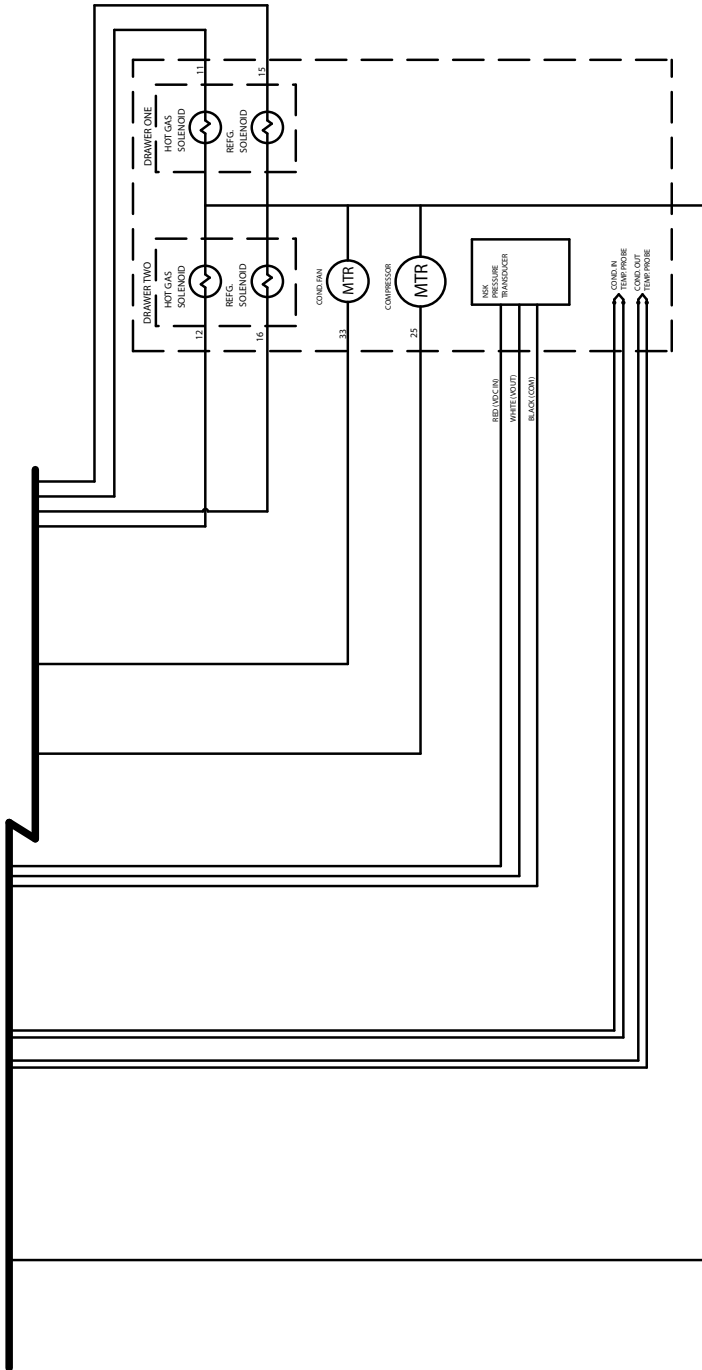

4-Drawer Wiring Schematic

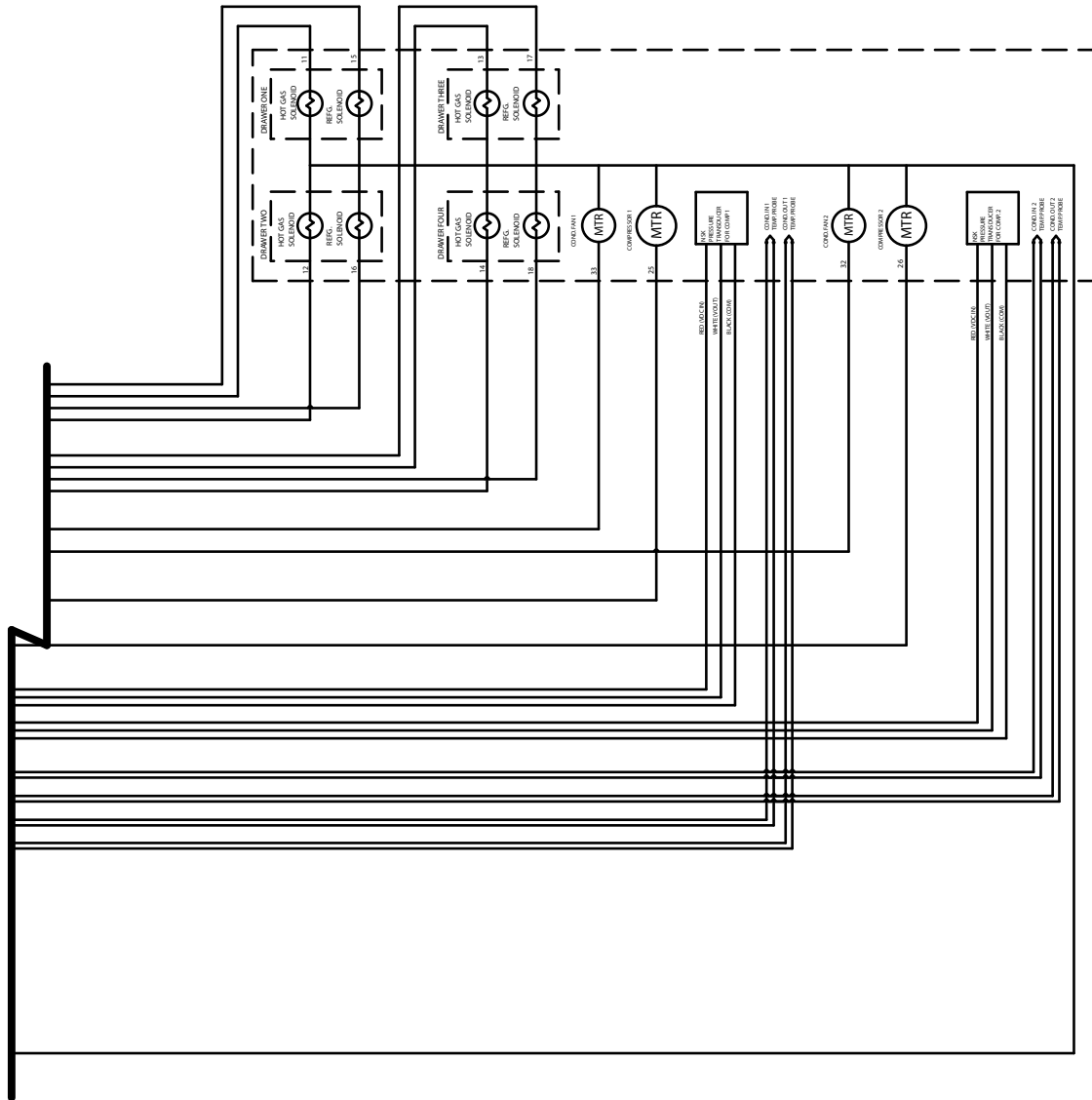
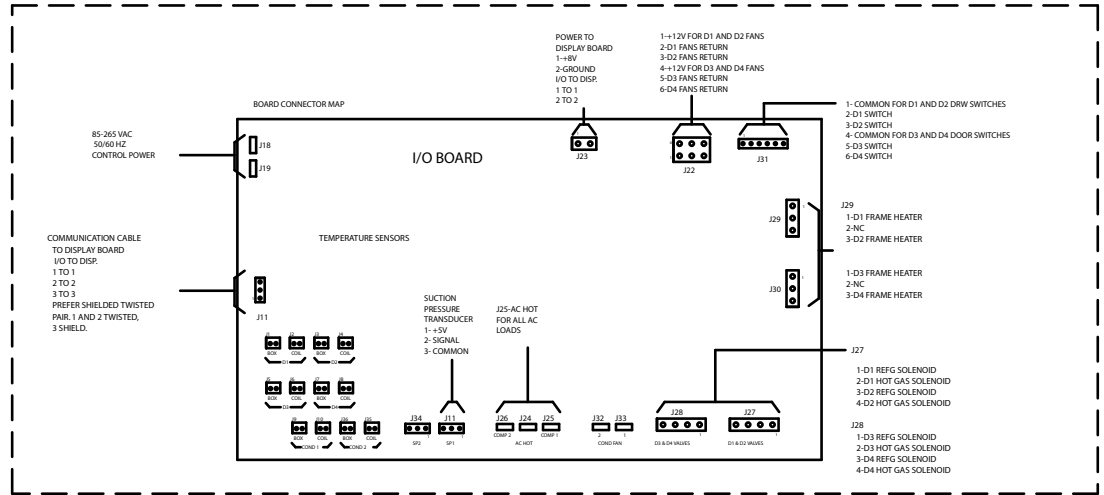

Versa Drawer™ Alarm

Alarm	Meaning	Action	Alternate Action
Thaw Finished	Thaw cycle is complete and unit is now in refrigeration mode.	Press corresponding drawer number to clear audio and screen.	
Chiller Finished	Chiller cycle has completed and unit is now in refrigeration mode.	Press corresponding drawer number to clear audio and screen.	
Drawer Open	Drawer's been open for greater than set time.	Close drawer.	
Drawer temperature Out of Range.	Drawer temperature's been 10 deg F above or below setpoint for more than 15 minutes.	Press corresponding drawer number to clear audio and screen.	
Loss of power	Power to unit was interrupted.	Press i button to stop audio alarm. Screen will change to display time power failed, time power was restored. Present time. Press i button once more to return to main screen	
Drawer temperature probe(s) out of range.	Temperature probe to drawer box or evaporator is damage or temperature is out of range.	Press i button to stop audio alarm, screen will clear once temperature drops into range or probe is repaired.	
Condenser temperature probe(s) out of range.	Temperature probe to condenser is damaged or temperature is out of range.	Press i button to stop audio alarm, screen will clear once temperature drops into range or probe is repaired.	
Compressor pressure transducer(s) out of range.	Pressure transducer damaged or pressure is higher than 150 psi	Press i button to stop audio alarm. If unit is started in high ambient temperature alarm will clear on pulldown. If diagnostics shows "open" for transducer, component must be repaired.	
Condenser fan(s) failure	Condenser fan has fail to pull down condenser outlet by 1 degree over two minutes. Condenser fan may not be operating or condenser coil is dirty.	Press i button to stop audio alarm. Alarm will remain on screen until service work is performed	The screen will clear if power to the unit is disconnected and reconnected. If alarm keeps reoccurring after power has been removed service is required.
Compressor(s) Failure	Compressor has failed to decrease suction pressure.	Press i button to stop audio alarm. Alarm will remain on screen until service work is performed	The screen will clear if power to the unit is disconnected and reconnected. If alarm keeps reoccurring after power has been removed service is required.

STANDARD LABOR GUIDELINES TO REPAIR OR REPLACE PARTS ON DELFIELD EQUIPMENT UNDER WARRANTY

Advice and recommendations given by Delfield Service Technicians do not constitute or guarantee any special coverage.

A maximum of 1-hour is allowed to diagnose a defective component.

A maximum of 1-hour is allowed for retrieval of parts not in stock.

A maximum travel distance of 100 miles round trip and 2-hours will be reimbursed.

Overtime, installation/start-up, normal control adjustments, general maintenance, glass breakage, freight damage, and/or correcting and end-user installation error will not be reimbursed under warranty unless pre-approved with a Service Work Authorization from Delfield. You must submit the number with the service claim.

LABOR OF 1 HOUR IS ALLOWED TO REPLACE:

- Solenoid Coil
- Hi-limit/Thermal Protector Switch
- Compressor Start Components and Overload Protector
- Evaporator/Condenser Fan Motor and Blade
- Door Hinges, Locks, and Gaskets

LABOR OF 2 HOURS TO REPLACE:

- Drawer Tracks/Cartridges
- Pressure Control
- Microprocessor Control
- Solenoid Valve
- Locate/Repair Leak

LABOR OF 3 HOURS TO REPLACE:

- Expansion Valve
- Condenser or Evaporator Coil

LABOR OF 4 HOURS TO REPLACE:

Compressor

This includes recovery of refrigerant and leak check.

\$55.00 (USD) maximum reimbursement for refrigerant recovery (includes recovery machine, pump, torch, oil, flux, minor fittings, solder, brazing rod, nitrogen, or similar fees.)

Refrigerants

R404A A maximum of \$16.00/lb.(0.43kg) (USD).

STANDARD ONE YEAR WARRANTY (ONE YEAR PARTS AND LABOR.)

The Delfield Company ("Delfield") warrants to the Original Purchaser of the Delfield product (herein called the "Unit") that such Unit, and all parts thereof, will be free from defects in material and workmanship under normal use and service for a period of one (1) year from the date of shipment of the Unit to the Original Purchaser or, if the Original Purchaser returns the warranty card completely filled out including the date of installation within thirty (30) days of receipt of the Unit, one (1) year from the date of installation. During this one year warranty period, Delfield will repair or replace any defective part or portion thereof returned to Delfield by the Original Purchaser which Delfield determines was defective due to faulty material or workmanship. The Original purchaser will pay all labor, crating, freight and related costs incurred in the removal of the Unit of defective component and shipment to Delfield, except that during a period of either ninety (90) days from the date of shipment of the Unit to the Original Purchaser or, if the Original Purchaser returns the warranty card completely filled out including the date of installation within thirty (30) days of receipt of the Unit, ninety (90) days from the date of installation Delfield will pay all related labor costs. Delfield will pay the return costs if the Unit or part thereof was defective.

The term "Original Purchaser" as used herein means that person, firm, association, or corporation for whom the Unit was originally installed.

This warranty does not apply to any Unit or part thereof that has been subjected to misuse, neglect, alteration, or accident, such as accidental damage to the exterior finish, operated contrary to the recommendations specified by Delfield; or repaired or altered by anyone other than Delfield in any way so as to, in Delfield's sole judgement, affect its quality or efficiency. This warranty does not apply to any Unit that has been moved from the location where it was originally installed. This warranty also does not cover the refrigerator drier or the light bulbs used in the Unit. The warranty is subject to the user's normal maintenance and care responsibility as set forth in the Service and Installation Manual, such as cleaning the condenser coil, and is in lieu of all other obligations of Delfield. Delfield neither assumes, nor authorizes any other person to assume for Delfield, any other liability in connection with Delfield's products.

Removal or defacement of the original Serial Number or Model Number from any Unit shall be deemed to release Delfield from all obligations hereunder or any other obligations, express or implied.

Parts furnished by suppliers to Delfield are guaranteed by Delfield only to the extent of the original manufacturer's express warranty to Delfield. Failure of the Original Purchaser to receive such manufacturer's express warranty to Delfield. Failure of the Original Purchaser to receive such manufacturer's warranty shall in no way create any warranty, expressed or implied, or any other obligation or liability on Delfield's part in respect thereof.

IF THE CUSTOMER IS USING A PART THAT RESULTS IN A VOIDED WARRANTY AND A DELFIELD AUTHORIZED REPRESENTATIVE TRAVELS TO THE INSTALLATION ADDRESS TO PERFORM WARRANTY SERVICE, THE SERVICE REPRESENTATIVE WILL ADVISE CUSTOMER THE WARRANTY IS VOID. SUCH SERVICE CALLS WILL BE BILLED TO CUSTOMER AT THE AUTHORIZED SERVICE CENTER'S THEN APPLICABLE TIME AND MATERIALS RATES. CONSIDER: CUSTOMER MAY INITIATE A SERVICE AGREEMENT WITHOUT PARTS COVERAGE.

Under no condition does this warranty give the Original Purchaser the right to replace the defective Unit with a complete Unit of the same manufacturer or of another make. Unless authorized by Delfield in writing, this warranty does not permit the replacement of any part, including the motor-compressor, to be made with the part of another make or manufacturer.

If shipment of a replacement part is requested prior to the arrival in the Delfield factory of the part claimed to be defective, the Original Purchaser must accept delivery of the replacement part of a C.O.D. basis, with credit being issued after the part has been received and inspected at Delfield's plant and determined by Delfield to be within this warranty.

No claims can be made under this warranty for spoilage of any products for any reason, including system failure.

The installation contractor shall be responsible for building access, entrance and field conditions to insure sufficient clearance to allow any hood(s), vent(s), or Unit(s) if necessary, to be brought into the building. Delfield will not be responsible for structural changes or damages incurred during installation of the Unit or any exhaust system.

Delfield shall not be liable in any manner for any default or delay in performance hereunder caused by or resulting from any contingency beyond Delfield's control, including, but not limited to, war, governmental restrictions or restraints, strike, lockouts, injunctions, fire, flood, acts of nature, short or reduced supply of raw materials, or discontinuance of the parts by the original part manufacturer.

Except as provided in any Additional Four Year Protection Plan, if applicable, and the Service Labor Contract, if applicable, the foregoing is exclusive and in lieu of all other warranties, whether written or oral, express or implied. This warranty supersedes and excludes any prior oral or written representations or warranties. Delfield expressly disclaims any implied warranties of merchantability, fitness for a particular purpose of compliance with any law, treaty, rule or regulation relating to the discharge of substances into the environment. The sole and exclusive remedies of any person relating to the Unit, and the full liability of Delfield for any breach of this warranty, will be as provided in this warranty.

Other than this Delfield Standard One Year Limited Warranty, any applicable Delfield Additional Four Year Protection Plan or applicable Delfield Service Labor Contract, the Original Purchaser agrees and acknowledges that no other warranties are offered or provided in connection with or for the unit or any other part thereof.

In no event will Delfield be liable for special, incidental or consequential damages, or for damages in the nature of penalties.

IF DURING THE WARRANTY PERIOD, CUSTOMER USES A PART FOR THIS DELFIELD EQUIPMENT OTHER THAN AN UNMODIFIED NEW OR RECYCLED PART PURCHASED DIRECTLY FROM DELFIELD OR ANY OF ITS AUTHORIZED SERVICE CENTERS AND/OR THE PART BEING USED IS MODIFIED FROM ITS ORIGINAL CONFIGURATION, THIS WARRANTY WILL BE VOID. FURTHER, DELFIELD AND ITS AFFILIATES WILL NOT BE LIABLE FOR ANY CLAIMS DAMAGES OR EXPENSES INCURRED BY THE CUSTOMER WHICH ARISE DIRECTLY OR INDIRECTLY, IN WHOLE OR IN PART, DUE TO THE INSTALLATION OF ANY MODIFIED PART AND/OR PART RECEIVED FROM AN UNAUTHORIZED SERVICE CENTER. If the warranty becomes void, Customer may purchase from Delfield, if available, a Service Agreement or service at the then current time and materials rate.

For more information on Delfield warranty's log on and check out the service section of our web site at www.delfield.com.

The Delfield Company

SERVICE LABOR CONTRACT

The Delfield Company (“Delfield”) offers this service labor contract (the “Service Labor Contract”), available at a nominal fee at the time of submission and acceptance of the order for the above listed Delfield unit (the “Unit”), in accordance with the following terms and conditions:

The Service Labor Contract is in addition to Delfield’s Standard One Year Limited Warranty (the “One Year Warranty”) and Delfield Additional Four Year Protection Plan (the “Four Year Warranty”). The terms and conditions of the One Year Warranty and the Four Year Warranty are set forth in their entirety in those warranties.

The Service Labor Contract covers the cost of labor where, in Delfield’s sole judgment, the Unit has proven to be defective in use and where recommended factory maintenance has been performed. The Service Labor Contract does not cover costs of initial installation or start-up, normal control adjustments or maintenance, food or business loss.

The one year Service Labor Contract shall cover those costs incurred by the Original Purchaser for a period of one (1) year from the date of shipment of the Unit to the Original Purchaser and the two year Service Labor Contract shall cover those costs incurred by the Original Purchaser for a period of two (2) years from date of shipment of the Unit to the Original Purchaser.

The term “Original Purchaser” as used herein means that person, firm, association, or corporation for whom the Unit was originally installed.

Any claims under this Service Labor Contract must be made in advance of the needed repairs. Delfield will not pay for repairs not authorized in advance. Upon completion of the repairs, an itemized statement must be submitted to Delfield’s Customer Service Department at the address below and must contain the following information:

- 1) Dealer name, invoice number, model number and serial number of the Unit.
- 2) Date the Unit was shipped.
- 3) Date the Unit failed, together with the name and address of the service agency called in to repair the Unit.
- 4) Full description of and circumstances surrounding the failure of the Unit.
- 5) Itemized bill of the repairs made to the Unit.

(continued)



The Delfield Company

(continued from previous page)

Upon review and approval of the claim by Delfield's Customer Service Department, payment will be made promptly only for the following costs:

- 1) Cost of service labor necessary to repair the Unit, provided that it is based on straight time only and the duration is, in the sole judgment of Delfield, within reason for the repair made.
- 2) Travel mileage of the service agency called upon to make the repair, provided the distance is, in the sole judgment of Delfield, with a reasonable radius of the installation site.
- 3) Cost of replacement parts, provided that permission to purchase locally was authorized by Delfield's Customer Service Department in advance of the purchase.

Delfield shall not be liable in any manner for any default or delay in performance hereunder caused by or resulting from any contingency beyond Delfield's control, including, but not limited to, war, governmental restrictions or restraints, strikes, lockouts, injunctions, fire, floods, acts of nature, short or reduced supply of raw materials, or discontinuance of the parts by the original part manufacturer.

This Service Labor Contract is offered on all Delfield units, except remote refrigerators, freezers and ventilation systems, installed in the United States and certain other pre-approved locations in Canada and Mexico (the "Approved Locations"). It is not available on cabinets supplied for remote installations nor on any units installed outside the Approved Locations. This Service Labor Contract does not cover repairs to any Unit that has been moved from the location where it was originally installed.

EXCEPT AS PROVIDED IN ANY APPLICABLE STANDARD ONE YEAR LIMITED WARRANTY OR APPLICABLE ADDITIONAL FOR YEAR PROTECTION PLAN, THE FOREGOING IS EXCLUSIVE AND IN LIEU OF ALL OTHER WARRANTIES, WHETHER WRITTEN OR ORAL, EXPRESS OR IMPLIED. THIS SERVICE LABOR CONTRACT SUPERSEDES AND EXCLUDES ANY PRIOR ORAL OR WRITTEN REPRESENTATIONS OR WARRANTIES. DELFIELD EXPRESSLY DISCLAIMS ANY IMPLIED WARRANTIES OF MERCHANTABILITY, FITNESS FOR A PARTICULAR PURPOSE OR COMPLIANCE WITH ANY LAW, TREATY, RULE OR REGULATION RELATING TO DISCHARGE OF SUBSTANCES INTO THE ENVIRONMENT. THE SOLE AND EXCLUSIVE REMEDIES OF ANY PERSON RELATING TO THE UNIT, AND THE FULL LIABILITY OF DELFIELD FOR ANY BREACH OF THE SERVICE LABOR CONTRACT, SHALL BE AS PROVIDED IN THIS SERVICE LABOR CONTRACT.

IN NO EVENT WILL DELFIELD BE LIABLE FOR SPECIAL, INCIDENTAL OR CONSEQUENTIAL DAMAGES, OR FOR DAMAGES IN THE NATURE OF PENALTIES.

ADDITIONAL FOUR YEAR PROTECTION PLAN (for motor-compressor only)

Delfield Model#	Serial #	Installation Date
<input type="text"/>	<input type="text"/>	<input type="text"/>

In addition to the Standard One Year Warranty on the Motor-Compressor contained in the above listed Delfield product (the "Unit"), The Delfield Company ("Delfield") also agrees to repair, or exchange with similar or interchangeable parts in design and capacity at Delfield's option, the defective Motor-Compressor contained in the Unit (the "Motor-Compressor"), or any part thereof, for the Original Purchaser only, at any time during the four (4) years following the initial one (1) year period commencing on the date of installation for the Original Purchaser. Failure of the Original Purchaser to register the registration card containing the Original Purchasers name, address, date of installation, model number and serial number of the Unit containing the Motor-Compressor within 30 days from the date of installation shall void this warranty. This additional warranty is only available if the Motor-Compressor is inoperative due to defects in material or factory workmanship, as determined by Delfield in its sole judgement and discretion. The Original Purchaser shall be responsible for returning the defective Motor-Compressor to Delfield prepaid, F.O.B. at the address shown on the back cover of this manual.

The term "Original Purchaser" as used herein means that person, firm, association, or corporation for whom the Unit was originally installed.

The term "Motor-Compressor" as used herein does not include unit base, air or water cooled condenser, receiver, electrical accessories such as relay, capacitors, refrigerant controls, or condenser fan/motor assembly. This warranty does not cover labor charges incidental to the replacement of parts. This warranty further does not include any equipment to which said condensing unit is connected, such as cooling coils, temperature controls or refrigerant metering devices. This warranty shall be void if the Motor-Compressor, in Delfield's sole judgement, has been subjected to misuse, neglect, alteration or accident, operated contrary to the recommendations specified by the Unit manufacturer, repaired or altered by anyone other than Delfield in any way so as, in Delfield's sole judgement, to affect its quality or efficiency or if the serial number has been altered, defaced or removed. This Warranty does not apply to a Motor-Compressor in any Unit that has been moved from the location where it was originally installed. The addition of methyl chloride to the condensing unit or refrigeration system shall void this warranty.

General Conditions

Delfield shall not be liable in any manner for any default or delay in performance hereunder caused by or resulting from any contingency beyond Delfield's control, including, but not limited to, war, governmental restrictions or restraints, strike, lockouts, injunctions, fire, flood, acts of nature, short or reduced supply of raw materials, or discontinuance of any part or the Motor-Compressor by the unit manufacturer.

Replacement of a defective Motor-Compressor is limited to one (1) Motor-Compressor by us during the four (4) year period. Delfield shall replace the Motor-Compressor at no charge.

This warranty does not give the Original Purchaser of the Motor-Compressor the right to purchase a complete replacement Motor-Compressor of the same make or of another make. It further does not permit the replacement to be made with a Motor-Compressor of another kind unless authorized by Delfield. In the event Delfield authorizes the Original Purchaser to purchase a replacement Motor-Compressor locally, only the wholesale cost of the Motor-Compressor is refundable.

Expressly excluded from this warranty are damages resulting from spoilage of goods.

Except as provided in any applicable Standard One Year Limited Warranty or applicable Service Labor Contract, the foregoing is exclusive and in lieu of all other warranties, whether written or oral, express or implied. This Warranty supersedes and excludes any prior oral or written representations or warranties. Delfield expressly disclaims any implied warranties of merchantability, fitness for a particular purpose or compliance with any law, treaty, rule or regulation relating to the Motor-Compressor, and the full liability of Delfield for any breach of this warranty, will be as provided in this warranty.

Other than any applicable Delfield Standard One year Limited Warranty, this Delfield Additional Four Year Protection Plan and any applicable Delfield Service Labor Contract, the Original Purchaser agrees and acknowledges that no other warranties are offered or provided in connection with or for the Motor-Compressor or any part thereof.

In no event will Delfield be liable for special, incidental or consequential damages, or for damages in the nature of penalties.



Mt. Pleasant, MI



Covington, TN

Thank you for choosing Delfield!

Help is a phone call away. Help our team of professional, courteous customer service reps by having your model number and serial number available at the time of your call (800) 733-8829.

Model: _____ S/N: _____

Installation Date: _____



For a list of Delfield's authorized parts depots, visit our website at www.delfield.com.

