



Installation, Start-Up and Service Instructions

50QT
— 112-130

Carrier Corporation • Syracuse, N.Y. 13221

Single-Package Heat Pumps

Chassis Only (Install ONLY after
50QT wall sleeve is in place)

CONTENTS

| | Page |
|---|------|
| SAFETY CONSIDERATIONS | 1 |
| INTRODUCTION | 1 |
| INSTALLATION | 1-4 |
| Step 1 — Check Equipment and Jobsite .. | 1 |
| • UNPACK UNIT | |
| • INSPECT EQUIPMENT | |
| • INSPECT WALL SLEEVE | |
| Step 2 — Install Chassis in Wall Sleeve | 3 |
| • SLIDE CHASSIS INTO SLEEVE | |
| Step 3 — Install Thermostat and | |
| Connect Thermostat Wiring | 3 |
| • TO MOUNT THERMOSTAT IN UNIT | |
| • TO MOUNT THERMOSTAT | |
| REMOTELY | |
| COLD CLIMATE ACCESSORY | 4 |
| START-UP | 4 |
| SERVICE | 4-14 |

SAFETY CONSIDERATIONS

Installation and servicing of air conditioning equipment can be hazardous due to system pressure and electrical components. Only trained and qualified service personnel should install, repair or service air conditioning equipment.

Untrained personnel can perform basic maintenance functions of cleaning indoor coil or replacing filter. All other operations should be performed by trained service personnel. When working on air conditioning equipment, observe precautions in the literature, tags and labels attached to the unit and other safety precautions that may apply.

Follow all safety codes. Wear safety glasses and work gloves. Use quenching cloth for brazing operations. Have fire extinguisher available for all brazing operations.

WARNING: Before performing service or maintenance operations on system, turn off main power switches to indoor unit and outdoor unit. Turn off accessory heater power switch if applicable. Electrical shock could cause personal injury.

IMPORTANT: Final wiring inspection by local authorities must be done before chassis is installed in sleeve.

WARNING: The 50QT chassis is an uncased unit and, therefore, requires special care in handling to prevent injury to installer and damage to unit. Avoid impact with walls or other standing objects when installing chassis. Be careful of sharp edges when handling chassis.

INTRODUCTION

Install Model 50QT112, 115 and 118 heat pump chassis in 50QT wall sleeve, Part No. 50QT900060; and Model 50QT124 and 130 chassis in 50QT wall sleeve, Part No. 50QT900080. Wall sleeves are shipped separately with accompanying installation instructions. All electrical power, ductwork and condensate drain hookups are made at time of wall sleeve installation.

IMPORTANT: Carrier standard outdoor grille Part No. 50QT900010 or deluxe outdoor grille Part No. 50QT900020 must be ordered separately and installed in wall sleeve before chassis is installed. *Do not run unit without proper outdoor grille in place.*

INSTALLATION

Step 1 — Check Equipment and Jobsite

UNPACK UNIT — Move to final location. Lift cardboard carton off chassis taking special care not to damage unit.

Table 1 — Electrical Data (60-Hz)

| MODEL 50QT | V/PH | OPER VOLTAGE* | | COMPR | | IFM OFM | | ELECTRIC HEATER AMPS | BRANCH CIRCUIT #1 (or Total Unit)† | | BRANCH CIRCUIT #2 (When Used)† | |
|-----------------------|-----------|------------------|-------|-------|------|---------|-----|-------------------------------------|---------------------------------------|-------------------------------------|--------------------------------------|-----|
| | | Max | Min** | LRA | RLA | FLA | FLA | | Max Fuse or HACR Ckt Bkr Amps‡ | MCA | Max Fuse or HACR Ckt Bkr Amps‡ | MCA |
| | | | | | | | | | | | | |
| 112300 AB AD | 208/230/1 | 254 | 187 | 37 | 6.8 | 1.5 | 1.0 | 9.4/12.5 18.0/20.8 | 25/30 35/40 | 22.8/26.6 33.5/37.0 | — | — |
| 115300 AB AD | 208/230/1 | 254 | 187 | 43 | 8.7 | 1.5 | 1.0 | 9.4/12.5 18.0/20.8 | 25/30 35/40 | 25.1/29.0 35.9/39.4 | — | — |
| 118300 AB AD AF | 208/230/1 | 254 | 187 | 49 | 10.3 | 1.7 | 1.0 | 9.4/12.5 18.0/20.8 26.8/31.3 | 30/35 40/45 50/55 | 27.3/31.2 38.1/41.6 49.1/54.7 | — | — |
| 124300 AD AF AG | 208/230/1 | 254 | 187 | 59 | 13.0 | 2.0 | 1.5 | 17.3/20.8 26.8/31.3 36.1/41.7 | 45/50 55/60 50/60 | 41.4/45.9 53.6/59.1 47.5/54.6 | — | — |
| 130300 AD AF AG | 208/230/1 | 254 | 187 | 79 | 16.9 | 2.4 | 1.5 | 17.4/20.8 26.8/31.3 36.0/41.7 | 50/55 35/40 50/55 | 47.5/52.1 33.5/39.1 45.0/52.1 | — | — |

*Permissible limits of the voltage range at which units will operate satisfactorily

†Field wiring to be sized for NEC or local codes. Use copper wire only

‡Maximum dual element fuse

**Minimum voltage is 197 when outdoor ambient temperature exceeds 105 F

NOTE: Dual values in this table (for example Electric Heater Amps 9.4/12.5) apply to 208- and 230-volt connections respectively

These units require 2 separate supply circuits. Refer to BOTH branch circuit charts for complete electrical data.

- FLA — Full Load Amps
- HACR — Heating, Air Conditioning and Refrigeration
- IFM — Indoor Fan Motor
- LRA — Locked Rotor Amps
- MCA — Minimum Circuit Amps
- OFM — Outdoor Fan Motor
- RLA — Rated Load Amps

→INSPECT EQUIPMENT for damage prior to installation. To remove plastic wrapper, grasp bottom and pull out until velcro strips separate. To remove metal cover plate, remove 6 screws. File claim with shipping company if shipment is damaged or incomplete.

Leave chassis bolted to skid and replace metal cover plate, plastic wrapper, and carton until ready for installation into wall sleeve.

INSPECT WALL SLEEVE installation for damage. Condensate drain pan must be free of debris and installed in accordance with local building regulations. Electrical connector on left side of sleeve should be free of dirt, grease, paint, etc. Connector must be properly wired before chassis installation. Duct connection panel must be level and duct connections complete. Do not rest weight of ductwork on duct connector panel. Inspect nameplate on sleeve to ensure wire and fuse sizing is correct for model size to be installed.

NOTE: If remote thermostat location is desired, location must be determined and accessory sub-base extension cord (Part No. 50QT900031) installed before wall completion.

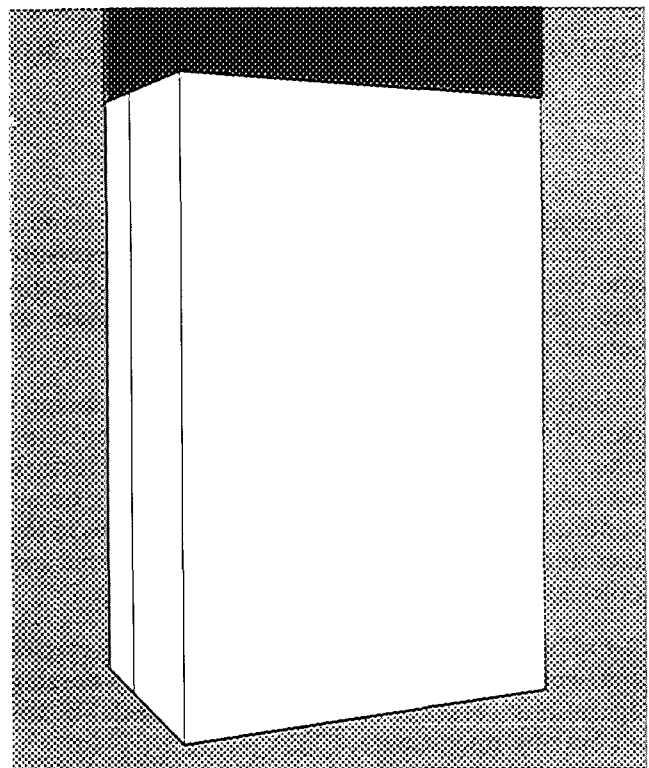

→ Fig. 1 — Chassis with Indoor Plastic Wrapper

Step 2 — Install Chassis in Wall Sleeve — Remove sleeve filler panel and save screws. Install outdoor grille using these screws. Remove indoor plastic wrapper as described in Step 1. Do not handle chassis with plastic wrapper in place.

IMPORTANT: Be sure disconnect per NEC installed with the wall sleeve is in OFF position before proceeding with chassis installation.

SLIDE CHASSIS INTO SLEEVE — Chassis is heavy. Portable lifting device must be used. Exercise caution to make sure forks do not damage chassis components (such as drain connections) while lifting and installing. Guide chassis into sleeve on indoor side by first placing chassis guide channels onto sleeve guide channels at bottom of sleeve. Slide chassis into sleeve until center partition perimeter meets gasket provided around outer edge of sleeve. Check electrical plugs for alignment as chassis is slid into place.

WARNING: Do not release chassis until installed completely into sleeve as it may fall out without warning.

Tighten chassis into place by driving 6 screws, provided in separate bag with chassis, into nuts provided on sleeve (see Fig. 3).

Electrical and condensate drain connections are complete when chassis is installed correctly into sleeve.

CAUTION: Tighten lag bolts uniformly. Failure to do so may cause misalignment and poor electrical connection.

Step 3 — Install Thermostat and Connect Thermostat Wiring — (Thermostat and subbase are packaged separately with unit shipment.) Thermostat can be installed in 50QT or in remote location.

TO MOUNT THERMOSTAT IN UNIT:

1. Remove metal cover plate by removing 6 screws.
2. Locate and install subbase onto thermostat bracket running between right and left coil partition (see Fig. 3). Push plug and wires through hole provided.
3. Connect plug from subbase to mating socket located on left coil partition (see Fig. 3).
4. Attach thermostat to subbase and snap on thermostat cover.
5. Cut hole in stenciled area on back side of wrapper with a sharp utility knife.
6. Cut and remove insulation from hole in metal cover plate.
7. Replace metal cover plate.

TO MOUNT THERMOSTAT REMOTELY:

1. Pull subbase extension cord, previously installed, up into the return air inlet. Plug cord into mating socket on the left-hand coil partition. (See Fig. 3.)

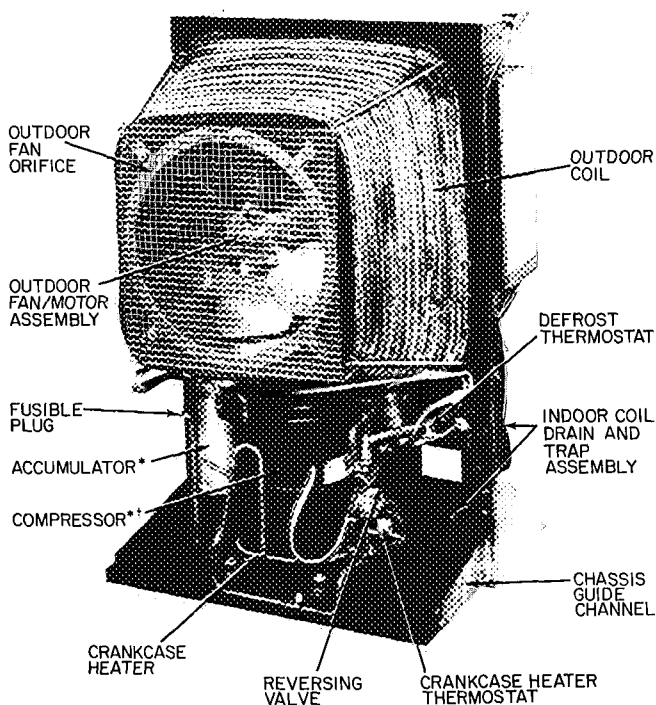

50QT112, 115, 118

*Accumulator and compressor location reversed on 50QT112
†Compressor guard removed

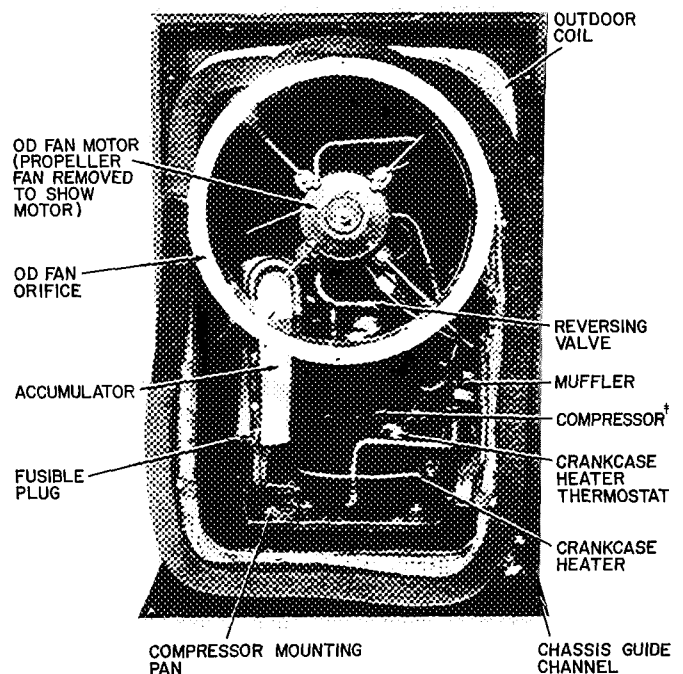

50QT124, 130

†Outdoor fan guard and compressor guard removed to show components

Fig. 2 — Outdoor Component Location

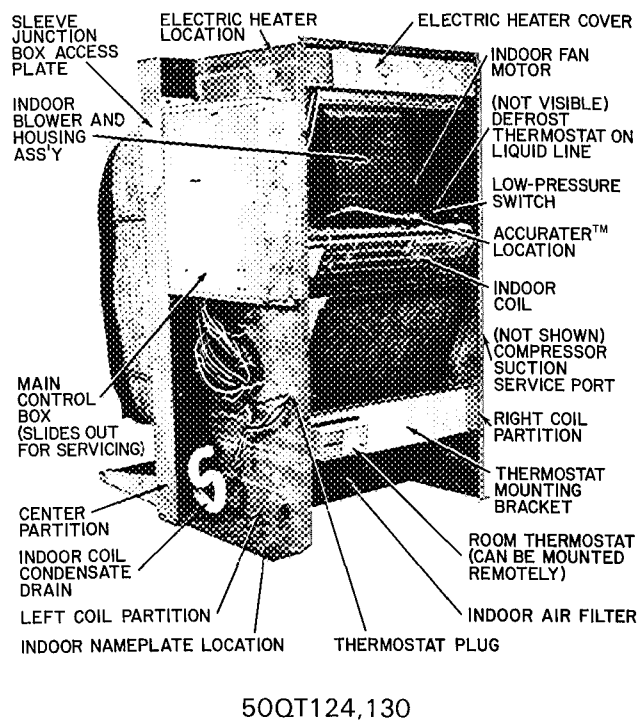
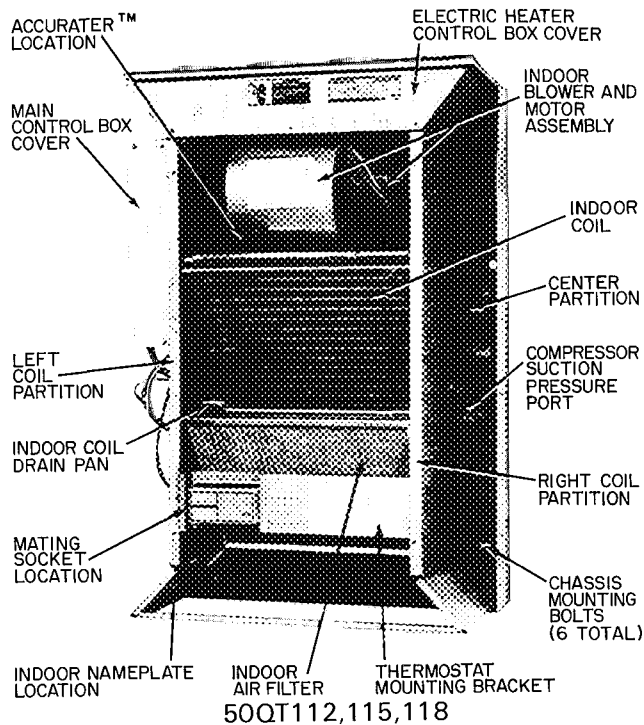

Fig. 3 — Indoor Component Location

2. Plug other end of cord, hanging from the wall at its remote location, securely into subbase.
3. Push plug and excess leads into wall hole. Cover hole appropriately to avoid incorrect thermostat readings.
4. Mount subbase onto wall.
5. Attach thermostat to subbase. Snap on cover and install chassis indoor cover.

→ COLD CLIMATE ACCESSORY

Cold climate accessory should be installed on 50QT100 units where the outdoor ambient temperature consistently falls below 30 F. Cold climate accessory is available in both six packs and single packs as indicated below: for 50QT112, 115, 118 — accessory part no. 50QT90016106 (six pack) or 50QT900160 (single pack); for 50QT124, 130 — accessory part no. 50QT90017106 (six pack) or 50QT900170 (single pack).

START-UP

Crankcase Heater — The 50QT compressor is equipped with a crankcase heater that is thermostatically activated in cold weather. (See Fig. 2 and 3.) If temperature is below 65 F, operate crankcase heater 24 hours before starting unit. To energize crankcase heater only, after chassis installation, set thermostat to $\leftarrow \bullet \rightarrow$ position and turn on unit power at disconnect switch.

Thermostat Anticipator — Room thermostat anticipator settings for all 50QT heat pumps is 0.20 amps. This setting may be changed slightly to

provide a greater degree of comfort for a particular installation.

To Start Unit — Check that main power is on and, if temperature is below 65 F, that compressor crankcase heater has been energized for at least 24 hours.

1. Set selector switch at $\leftarrow \bullet \rightarrow$.
2. Set fan switch as desired (FAN) (AUTO.).
3. Set thermostat lever at the desired temperature.
4. Set selector switch at HEAT or COOL. Check system refrigerant charge. See Refrigerant Charging.

SERVICE

Low-Pressure Switch (Safety Control) is located on liquid line downstream of AccuRater™ control during cooling mode (or upstream of AccuRater control during heating mode). Switch opens at 5 psig and shuts down compressor to protect it from overheating if refrigerant charge is too low. High and low side pressure connections are accessible from the indoor portion of the unit for charging. (See Fig. 3.)

High-Pressure Relief Valve (Safety Control) is located in compressor. Relief valve opens at a pressure differential of approximately 450 ± 50 psi between suction (low side) and discharge (high side) to allow pressure equalization.

Internal Current and Temperature Sensitive Overload (Safety Control) resets automatically when compressor motor temperature drops to a safe level (overloads may require up to one hour to reset).

When an internal overload is suspected of being open, check by using an ohmmeter or continuity tester. If necessary, refer to Carrier Standard Service Techniques Manual, Chapter 2, Electrical, for complete instructions.

Defrost Control, consisting of a defrost timer, defrost thermostat and defrost relay, interrupts normal system heating operation to remove frost and ice formation on outdoor coil. Frost impairs unit performance. Defrost control simultaneously stops outdoor fan, energizes reversing valve solenoid to switch system into cooling cycle (outdoor unit as condenser, indoor unit as evaporator), and activates electric heater. Unit can defrost every 90 minutes, but will do so only if outdoor temperatures are in the frosting temperature zone.

For heat pump to defrost, 2 conditions are necessary:

1. Defrost timer contacts must be closed.
2. Coil temperature must be cold enough to cause defrost thermostat contacts to close.

Contacts close at 28 ± 3 F (50QT112 - 118) and 35 ± 3 F (50QT124, 130). Every 90 minutes of elapsed running time, the defrost timer contacts close for 10 seconds. If the defrost thermostat contacts are closed, the unit defrosts. The defrost timer limits defrosting period to 10 minutes. Normally the frost is removed and the defrost thermostat contacts will open to terminate defrosting before 10 minutes have elapsed. Defrost thermostat contacts open at 65 ± 5 F (50QT112 - 118) and 75 ± 5 F (50QT124,130). When defrosting is terminated, the outdoor fan motor is energized and reversing valve solenoid is de-energized, returning unit to heating cycle.

HEAT PUMP CIRCUITS shown in Fig. 4 are refrigerant flow diagrams for heating and cooling cycles.

Refrigerant Charging

CAUTION: To prevent personal injury, wear safety glasses and gloves when handling refrigerant.

Do not overcharge system. An overcharge can cause compressor flooding.

Unit refrigerant system is factory charged. When recharging is necessary, weigh in total charge indicated in Table 2. (Charge must be weighed in during heating season.) Remove any refrigerant remaining in system before recharging. If system has lost complete charge, triple-evacuate system to 5000 microns (29.7 in. vacuum) before recharging. Service port connections are provided on unit suction and discharge lines for evacuation and charging. (See Fig. 4 for service port location.) Dial-a-charge charging cylinder is an accurate device used to recharge systems by weight. These cylinders are available at refrigeration supply firms.

Table 2 — Service Data

| UNIT 50QT | 112 | 115 | 118 | 124 | 130 |
|-------------------|---|-------------|-------------|-------------|--------------|
| MODEL | 300 | 300 | 300 | 300 | 300 |
| R-22 CHARGE* (lb) | 2.7 | 2.7 | 3.2 | 4.5 | 4.7 |
| Refrig Control | AccuRater™ Bypass Type | | | | |
| INDOOR FAN | Centrifugal Blower, Direct Drive, 2-Speed | | | | |
| Rotation† | CW | CW | CW | CCW | CCW |
| Rpm | 1580 | 1550 | 1570 | 1675 | 1675 |
| Diameter (in.) | 6 | 6 | 6 | 7 | 7 |
| Width (in.) | 8 | | | | |
| Range (cfm) | 430/ 375 | 550/ 475 | 575/ 480 | 885/ 800 | 1025/ 960 |
| Motor Hp | 1/5 | 1/5 | 1/5 | 1/4 | 1/4 |
| OUTDOOR FAN | Propeller, Direct Drive, Single Speed | | | | |
| Cfm | 1700 | 1700 | 1700 | 2000 | 2000 |
| Rpm | 1125 | | | | |
| Diameter (in.) | 15 | | | | |
| Motor Hp | 1/8 | | | | |

CCW — Counterclockwise
CW — Clockwise

*Factory refrigerant charge
†Looking at fan motor shaft

To check and/or adjust charge during cooling season, use Cooling Cycle Charging Charts (Fig. 5, 7, 9, 11, 13) and follow Charging Chart Method below. The charging chart may also be used as an alternate method of recharging system.

To check *system operation* during heating cycle, use Heating Cycle Operation Check Chart (Fig. 6, 8, 10, 12, 14). These charts indicate whether a correct relationship exists between system operating pressures and air temperatures entering unit. If pressure and temperature lines do not intersect on chart, the system refrigerant charge may not be correct or other system abnormalities may exist. Do not use Operating Check Charts to adjust refrigerant charge. Weigh charge into system.

COOLING CYCLE CHARGING CHART METHOD

1. Operate unit a minimum of 10 minutes before checking charge, and after each charge adjustment.
2. Measure suction pressure by attaching a gage to unit suction service port. (See Fig. 4 for correct service port location.)
3. Measure outdoor (coil inlet) air dry-bulb temperature. Use service thermometer.
4. Using a sling psychrometer, measure wet-bulb temperature of air entering indoor fan coil.
5. Refer to Charging Chart. Locate on curves where outdoor air dry-bulb and indoor air wet-bulb temperature lines intersect.
6. From intersect point, project vertically downward to chart suction pressure line. Compare chart suction pressure to unit suction pressure (Step 2).
7. If unit suction pressure is lower than chart pressure, add refrigerant to system until chart pressure is reached. If unit suction pressure is higher than chart pressure, remove refrigerant until chart pressure is reached.

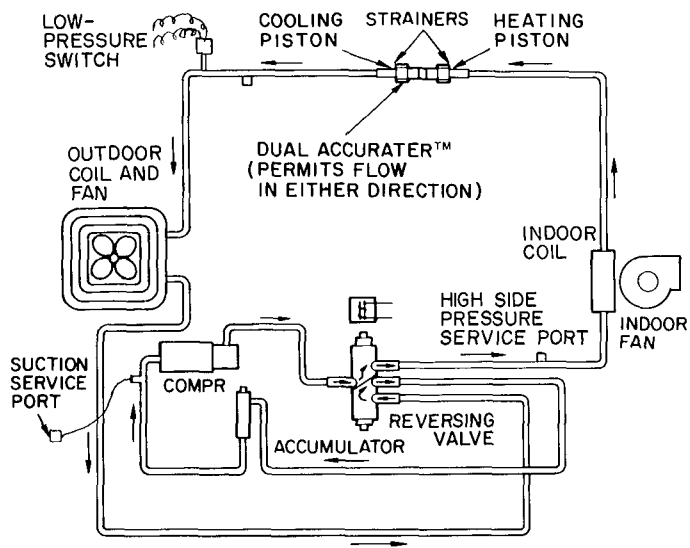

HEATING CYCLE

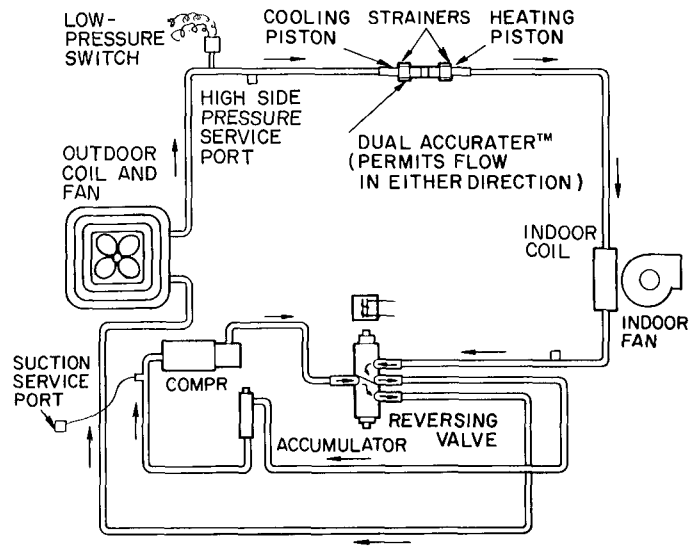

COOLING CYCLE

Unit Piping

Fig. 4 — 50QT Refrigerant Flow Diagrams

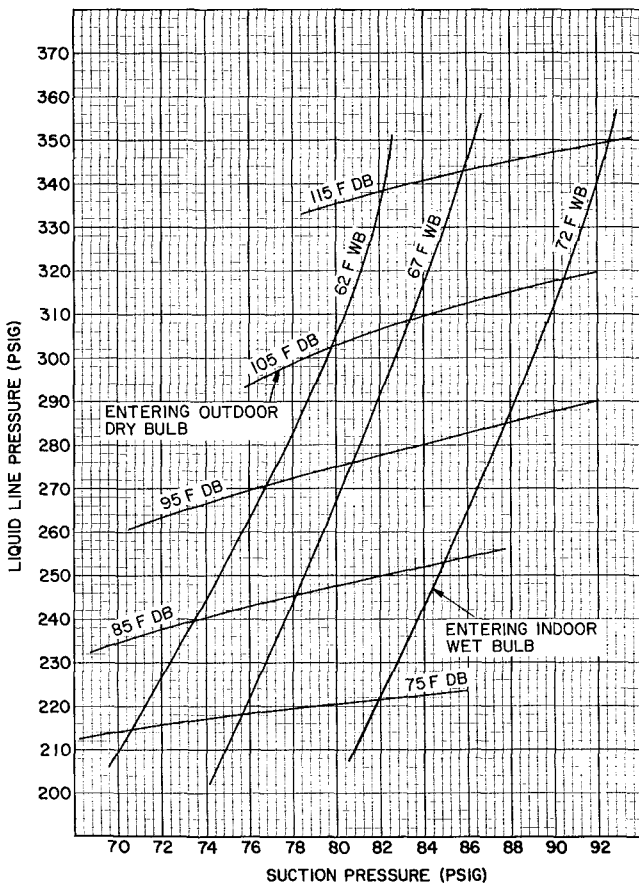

Fig. 5 — 50QT112 Cooling Cycle Charging Chart

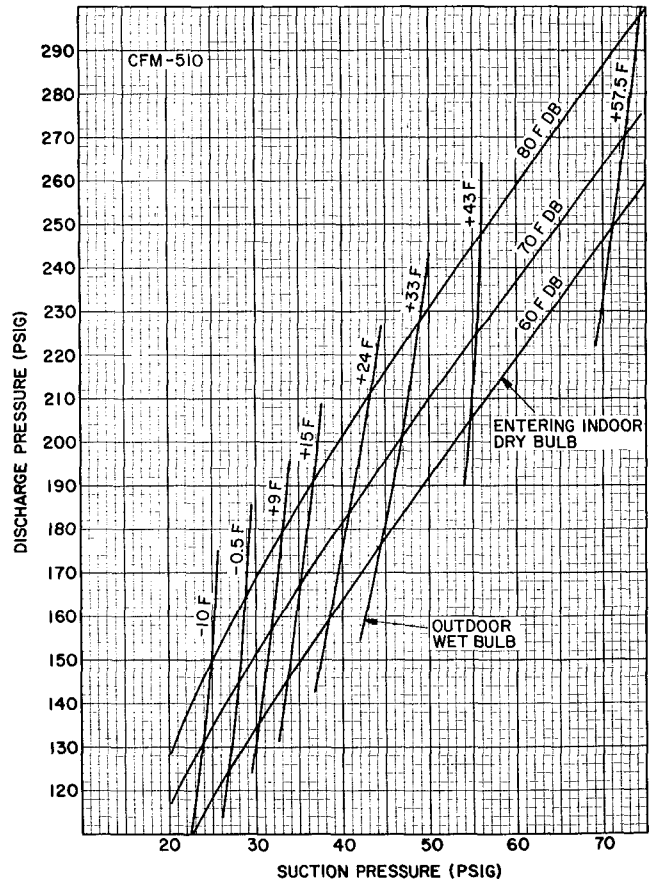

Fig. 6 — 50QT112 Heating Operation Check Chart

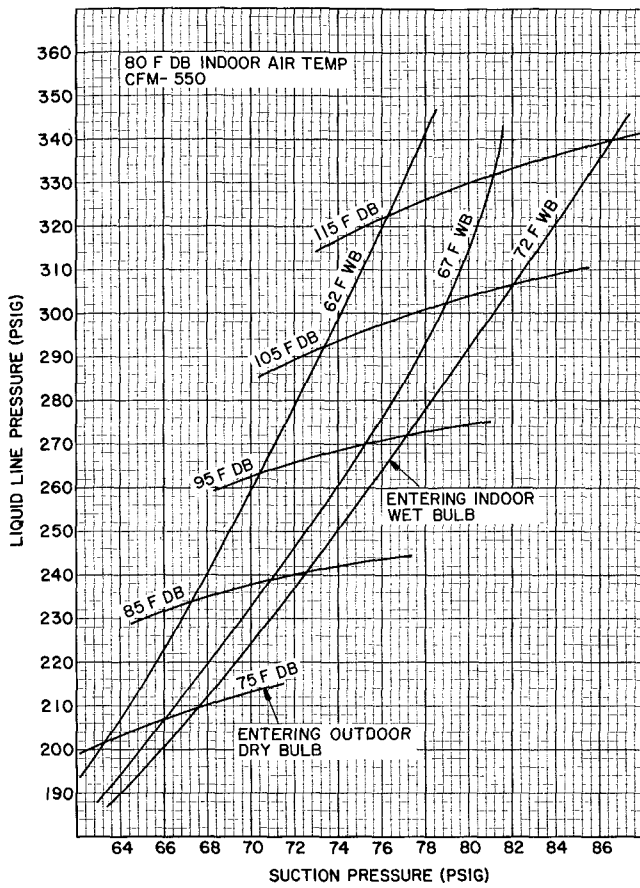

Fig. 7 — 50QT115 Cooling Cycle Charging Chart

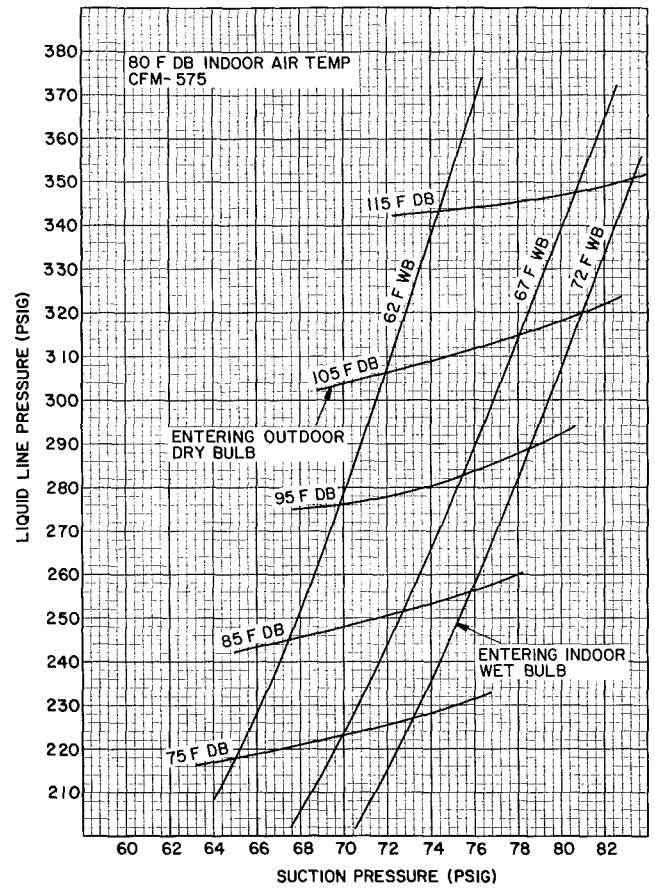

Fig. 9 — 50QT118 Cooling Cycle Charging Chart

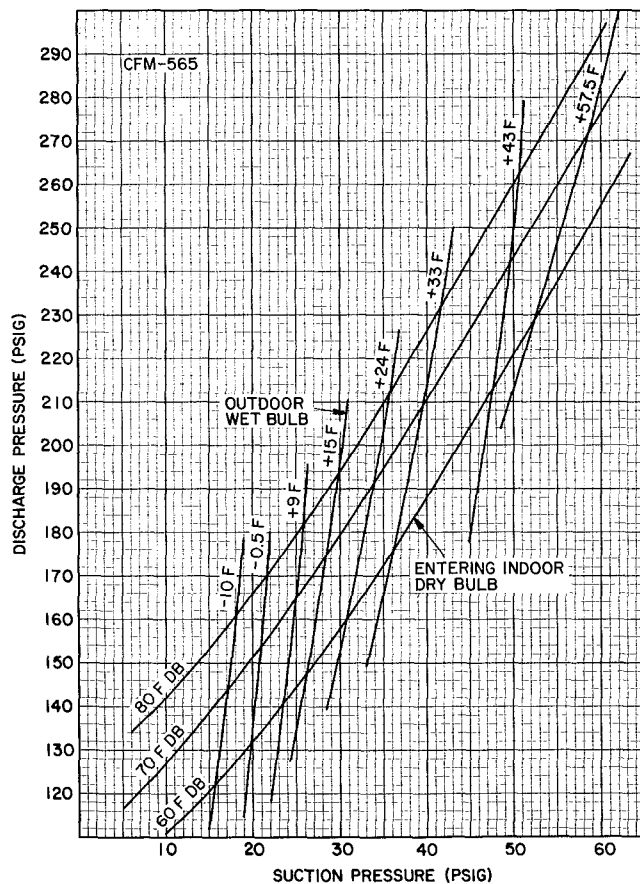

Fig. 8 — 50QT115 Heating Operation Check Chart

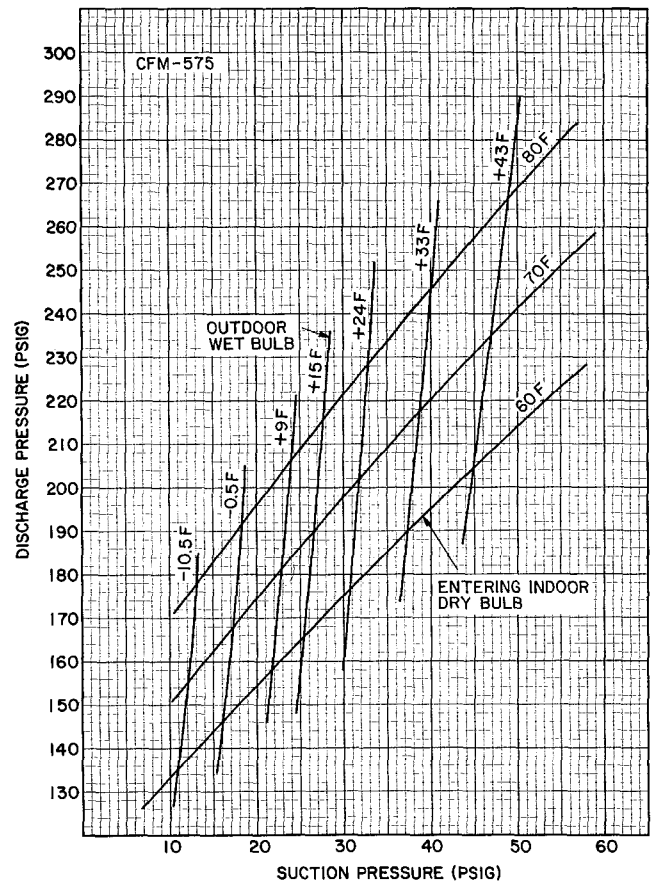

Fig. 10 — 50QT118 Heating Operation Check Chart

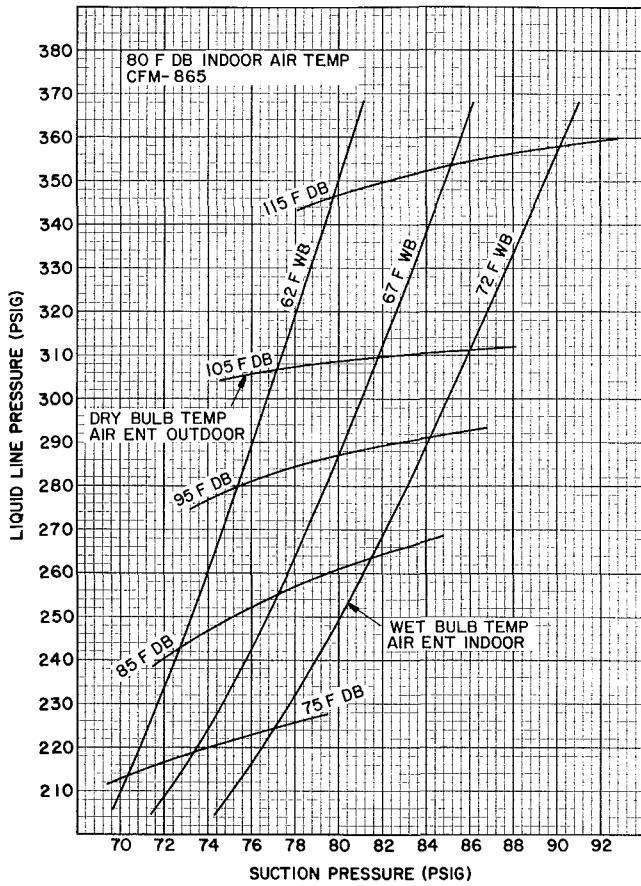

Fig. 11 — 50QT124 Cooling Cycle Charging Chart

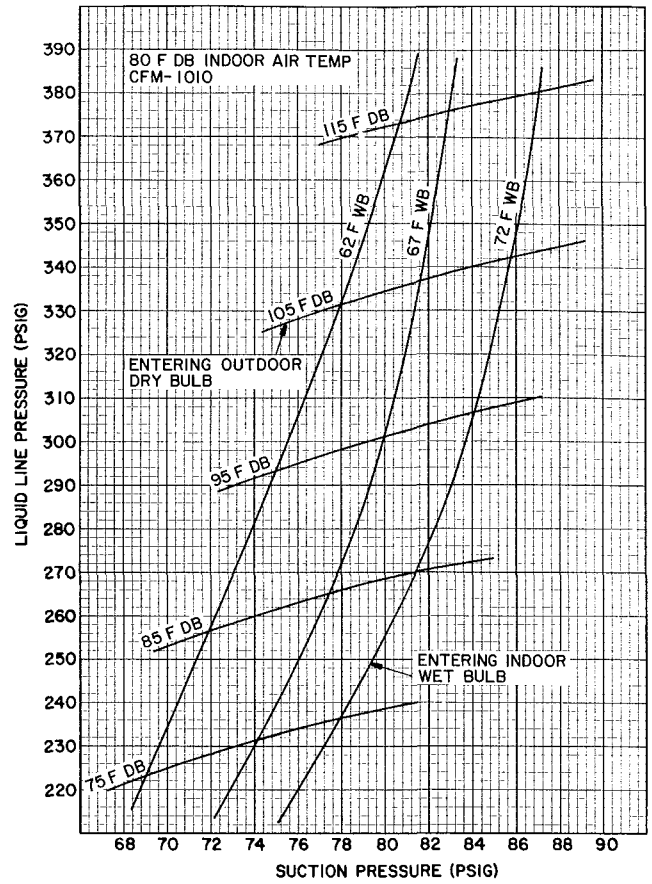

Fig. 13 — 50QT130 Cooling Cycle Charging Chart

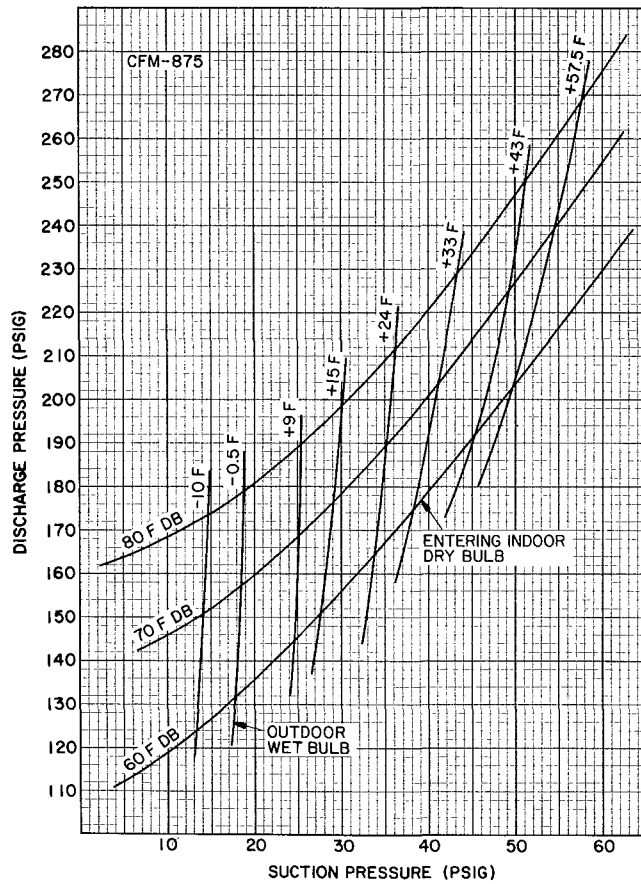

Fig. 12 — 50QT124 Heating Operation Check Chart

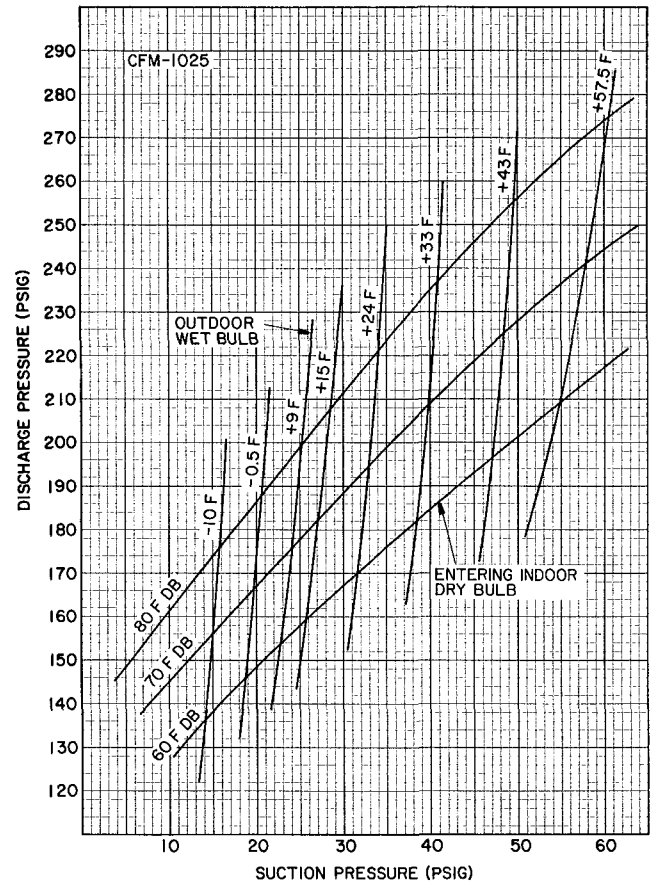

Fig. 14 — 50QT130 Heating Operation Check Chart

AccuRater™ Device (Dual-Piston Type) Servicing — See Fig. 15 for dual-piston AccuRater components. The pistons have a refrigerant metering orifice through them. The retainers form a stop for the pistons in the refrigerant bypass mode, and a sealing surface for liquid line flare connection. To clean or replace piston:

1. Shut off power to unit.
2. Protect area around unit to prevent damage to interior, furnishings, etc.
3. Remove refrigerant from unit.
4. Remove liquid line flare connections from AccuRater. See Fig. 3 for AccuRater location.
5. Note position of arrow on AccuRater body in relation to unit.
6. Pull retainer out of body. Be careful not to scratch flare sealing surface. If retainer does not pull out easily, carefully use locking pliers to remove retainer. Replace scratched or damaged retainer.
7. Slide piston out by inserting a small soft wire through metering hole (18-gage thermostat wire). Check that metering hole, sealing surface around piston cones and fluted portion of piston are not damaged.
8. See chart on indoor blower scroll for illustration of proper arrangement and sizes of pistons.
9. Clean piston refrigerant metering orifice.
10. Replace retainer O-ring before reassembling AccuRater. Carrier O-ring Part No. is 99CC501052.

LIQUID LINE STRAINERS (protect AccuRater), are made of wire mesh and located in the liquid line on each side of the AccuRater. The strainers are pressed into the line. Remove strainer by threading a #10 sheet metal screw into strainer and pulling the screw with pliers.

Compressor Removal — (Refer to Fig. 2.)

IMPORTANT: Compressor cannot be removed from an installed chassis. Remove chassis from sleeve, then bring to service truck or dealer shop before removing compressor.

See Table 3 for compressor information. Follow safety codes and wear safety glasses and work gloves. Have quenching cloth available.

CAUTION: Aluminum tubing is used in 50QT coils. Do not overheat or place excessive strain on tubing or damage may result.

Table 3 — Compressor Data

| UNIT 50QT | COMPRESSOR | OIL RECHARGE (oz) |
|-----------|-------------------------|-------------------|
| 112 | Copeland RE-Z3-0150-PFV | 20 |
| 115 | Tecumseh AB5515H | 32 |
| 118 | Copeland CRB1-0175-PFV | 51 |
| 124 | Copeland CRD-10200-PFV | 51 |
| 130 | Copeland CRF1-0250-PFV | 51 |

Compressor Removal — 50QT112, 115, 118

1. Shut off power to unit. Remove chassis indoor cover, Fig. 1.
2. Remove chassis to truck or shop.
3. Remove refrigerant from unit using refrigerant removal methods described in Carrier Standard Service Techniques Manual, Chapter 1, Refrigerants.
4. Remove core from suction and discharge line Schrader valves.
5. Remove compressor guard.

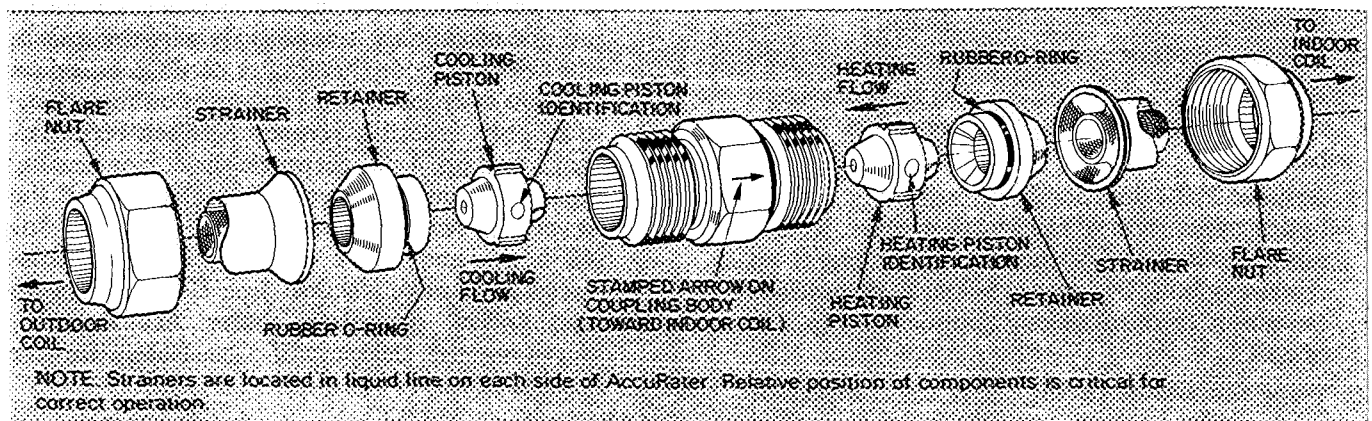

Fig. 15 — AccuRater Device (Dual-Piston) Components

6. Disconnect compressor wiring at compressor terminal box.
7. Using a tubing cutter, cut suction and discharge lines at convenient place near compressor for easy reassembly to new compressor with copper slip couplings.

CAUTION: Excessive movement of copper lines at compressor may cause a break where lines connect to other system components.

8. Remove crankcase heater from compressor base.
9. Remove clamp holding accumulator to shell.
10. Remove compressor holddown bolts and lift compressor out, sliding and tipping it towards the outside.
11. Carefully unbraid suction and discharge line piping stubs from compressor. If oil vapor in piping stubs ignites, use quenching cloth.
12. Braze piping stubs (removed in step 11) on new compressor, in same position as before.
13. Install new compressor in unit. Braze suction and discharge lines to compressor piping using field-supplied copper couplings. Ensure compressor holddown bolts are in place. Reinstall crankcase heater. Connect wiring.
14. Triple-evacuate to 5000 microns and recharge unit. See Refrigerant Charging section.
15. Refer to NOTE at the end of this section for important information.

Compressor Removal — 50QT124, 130

1. Shut off power to unit. Remove chassis indoor cover, Fig. 1.
2. Remove chassis to truck or shop.
3. Remove refrigerant from unit using refrigerant removal methods described in Carrier Standard Service Techniques Manual, Chapter 1, Refrigerants.
4. Remove core from suction and discharge line Schrader valves.
5. Remove outdoor fan guard.
6. Remove outdoor compressor guard.
7. Remove outdoor propeller fan.
8. Remove outdoor fan orifice ring by removing 4 screws attaching it to outdoor fan motor bracket.
9. Remove 3 of 4 outdoor fan motor bolts, leaving bolt at upper right of fan motor in place. Rotate motor up and out of the way by hinging it on remaining bolt. Use wire or solder to tie outdoor fan motor to outdoor coil support on top side of coil.
10. Using a miniature tubing cutter, cut compressor suction tube on short vertical run as tube enters compressor.

11. Cut compressor discharge tube on horizontal tubing run approximately 6 to 12 in. from where it leaves the compressor. Keep crankcase heater thermostat on right side of cut so it stays in place when compressor is removed.
12. Disconnect compressor wiring at compressor terminal box. Remove compressor wires and crankcase heater splice from box.
13. Using an 18-in. long extension on ratchet wrench, remove 4 compressor holddown bolts.
14. Slide compressor out to edge of pan. Remove crankcase heater by loosening worm drive clamp and sliding over top of compressor.
15. Remove compressor from pan.
16. Carefully unbraid suction and discharge line piping stubs from compressor. If oil vapor in piping stubs ignites, use quenching cloth.
17. Braze piping stubs (removed in step 11) on new compressor, in same direction as before.
18. Using field-supplied copper couplings, install new compressor in unit.
19. Reassembly is reverse of above procedure.
20. Triple-evacuate to 5000 microns and recharge unit. See Refrigerant Charging section.

NOTE: If a compressor failure was caused by motor winding burnout, the by-products of the burnout must be separated from the circulating refrigerant. This must be done before the by-products enter the reversing valve or accumulator and render parts inoperative. Burnout by-products can cause future system operating problems if left in the system.

Clean the system by installing a suction line drier in the refrigerant line where the suction gas enters the reversing valve. During the cooling cycle, this is the line from the indoor coil running to the compressor compartment; during heating cycle, install drier in line between outdoor coil and reversing valve. If possible, run unit in cooling mode when cleaning system as no defrosting occurs.

To provide protection for the 4-way valve, do not place filter drier between 4-way valve and accumulator. Since the suction drier works on one mode only, temporarily wire the unit in the selected mode (heating or cooling, based on suction drier location). To insure cooling operation only, install a jumper between terminals no. 1 and no. 4 on receptacle no. 3. For heating operation only, remove and insulate one of the reversing valve solenoid leads. Run unit for 48 hours and check oil for acidity. If satisfactory, remove suction line drier. Refer to and follow procedure under AccuRater™ Servicing for cleaning of AccuRater. Rewire unit to normal condition.

Lubrication — Compressor contains factory oil charge. Replace oil when lost. See Table 3 for oil

recharge. If necessary, refer to Carrier Standard Service Techniques Manual, Chapter 1, Refrigerants, page 1-21, for oil recharging procedure. Use Carrier PP33-1, Texaco WF-32 or Suniso 3GS oil.

FAN MOTOR BEARINGS — Oiling holes are provided at each end of condenser fan motor. Remove fan motor and lubricate motor with 32 drops (16 drops per hole) of SAE 10 nondetergent oil at intervals described below:

- Annually, when environment is very dirty, ambient temperature is higher than 105 F and average unit operating time exceeds 15 hours a day.
- Every 3 years when environment is reasonably clean, ambient temperature is less than 105 F and unit operating time averages 8 to 15 hours a day.
- Every 5 years when environment is clean, ambient temperature is less than 105 F and unit operating time averages less than 8 hours a day.

INDOOR MOTOR — To oil indoor motor, remove dust caps or plugs from oil holes located at each end of the motor. Use a teaspoon, 5 cc (5 ml), 3/16 oz or 16 to 25 drops of a good grade of SAE 20 nondetergent motor oil in each oil hole. Allow time for total quantity of oil to be absorbed into each bearing. After oiling motor, be sure to wipe off excess oil from housing and replace cap or plugs on oil port.

Outdoor Coil Cleaning — To be done at the beginning of each cooling season or more often if required.

CAUTION: Fin damage or removal can result in higher operating costs or compressor damage. Do not use flame, high-pressure water, steam, or volatile or corrosive cleaners on fins and tubing. Follow these instructions carefully. Contact your dealer if you encounter problems.

- Shut off power to unit.
- Remove chassis from sleeve by removing 6 bolts and sliding chassis out. Transport chassis to an appropriate cleaning location.
- Clean coil using vacuum cleaner and its crevice tool (see Fig. 16). Work crevice tool perpendicularly to coil tubes, making sure tool only touches dirt on fins. To prevent fin removal, do not "scrub" fins with tool or move tool parallel to coil tube configuration.

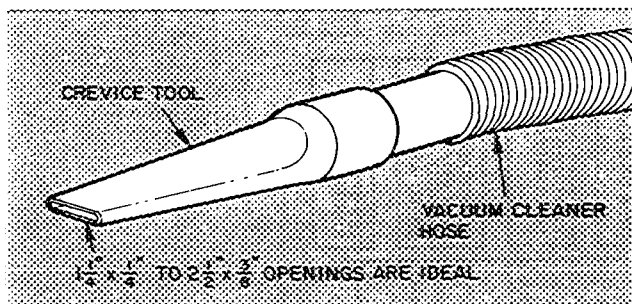

Fig. 16 — Crevice Cleaning Tool

- If oil deposits are present, spray coil with liquid household detergent. Wait 10 minutes, then proceed to step 5.
- Using garden hose, spray coil perpendicularly to coil tubes with a constant stream of water at moderate pressure (see Fig. 17). Keep nozzle at a 15 to 20 degree angle, about 3 in. from coil face and 18 in. from tube. Spray so debris is washed out and away from coil making sure water does not contact components on side of chassis.

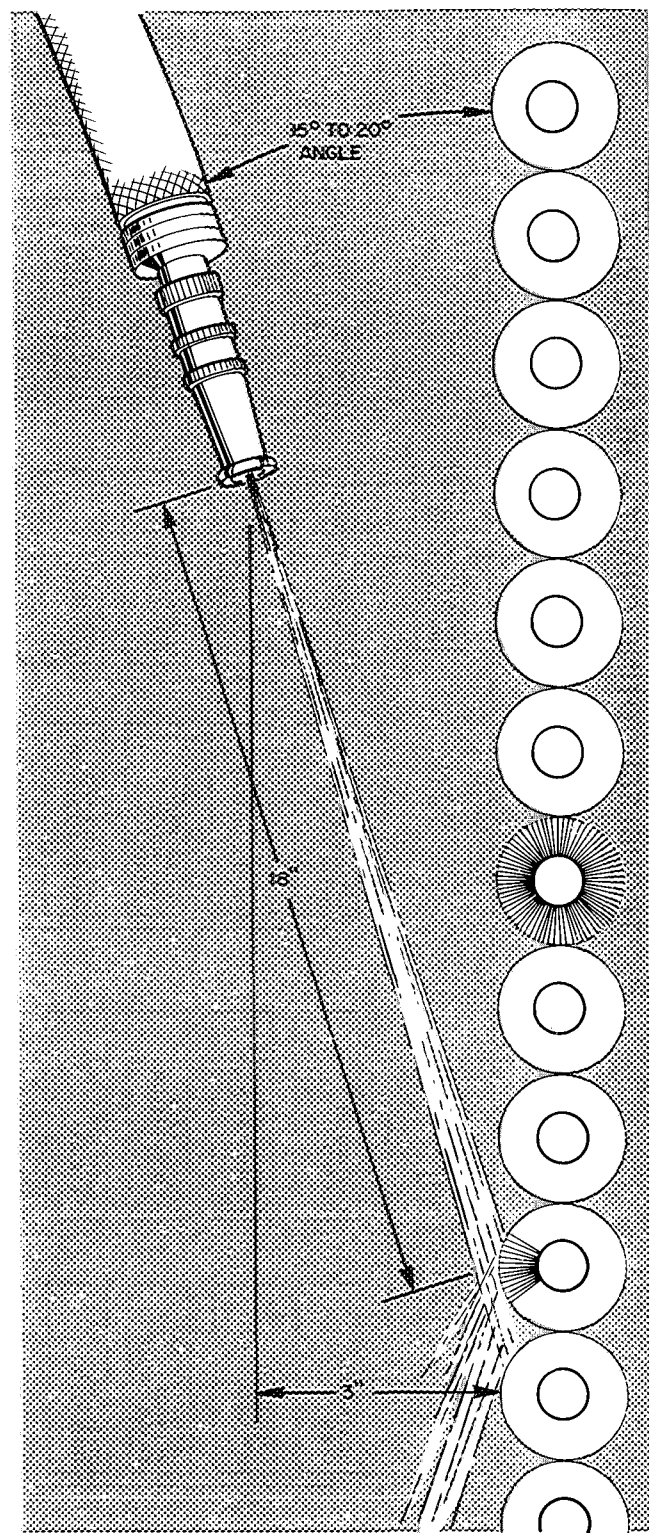

Fig. 17 — Positioning Hose to Spray Coil

6. Make sure condensate pan drain is not clogged with debris.
7. Reinstall chassis in sleeve.
8. Restore power to unit.

Indoor Coil and Condensate Pan Cleaning — Clean and inspect indoor coil, condensate pan and drain at same time outdoor coil is cleaned.

1. Use vacuum cleaner nozzle to clean the face of coil.
2. Clean condensate pan with a brush similar to that shown.



3. Hold pail under condensate pan drain connection and flush pan by slowly pouring water on coil. Do not overflow pan.

Indoor Air Filter Replacement (Refer to Fig. 3.) — Replace filters at least 4 times per year especially at the beginning of the heating and cooling seasons.

On 50QT112, 115 and 118, slide filter through slots at bottom of left and right coil partitions. Slide filter upward until top of filter reaches top of filter brackets. Then, rest bottom of filter on bottom flanges of left and right coil partitions.

On 50QT124 and 130, slide filter upward until top of filter reaches top of filter brackets. Then, rest bottom of filter on horizontal sheet metal shelf between left and right coil partitions making sure tabs at bottom of filter brackets hold filter in place.

Outdoor Fan Adjustment — Required fan position is shown in Fig. 18. Adjust position by loosening setscrew on fan hub and moving in or out of orifice.

Outdoor Fan/Motor Removal

1. Shut off power to unit.
2. Remove chassis from sleeve as described previously in Outdoor Coil Cleaning section.

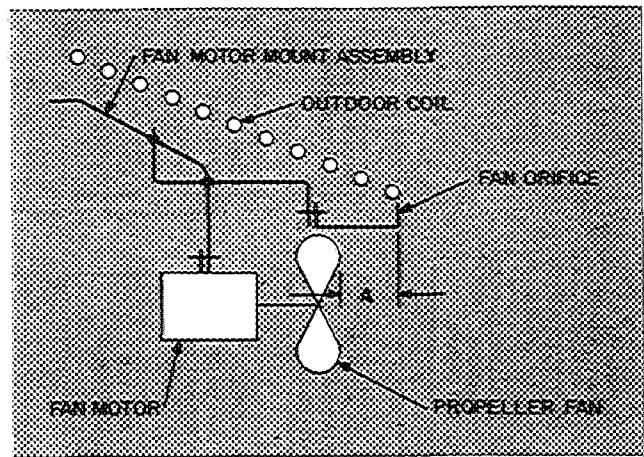

| UNIT 50QT | DIMENSION A (in.) |
|---------------|----------------------|
| 112, 115, 118 | 2½ |
| 124, 130 | 2 |

Fig. 18 — Outdoor Fan Position

3. Remove 4 nuts from outer tip of coil support rods and remove wire mesh guard.
4. Remove fan blade from motor shaft by loosening hub setscrews and slipping it off shaft.
5. Remove fan motor leads from electrical components in indoor side control box and pull through bulkhead so they are loose in outdoor machine compartment.
6. Remove nuts and bolts connecting 4 motor ears to motor support struts.
7. Remove motor and leads.
8. Reassembly is reverse of above procedure. Make sure guard is replaced and fan is positioned correctly as in Fig. 2.

TROUBLESHOOTING CHART — COOLING CYCLE

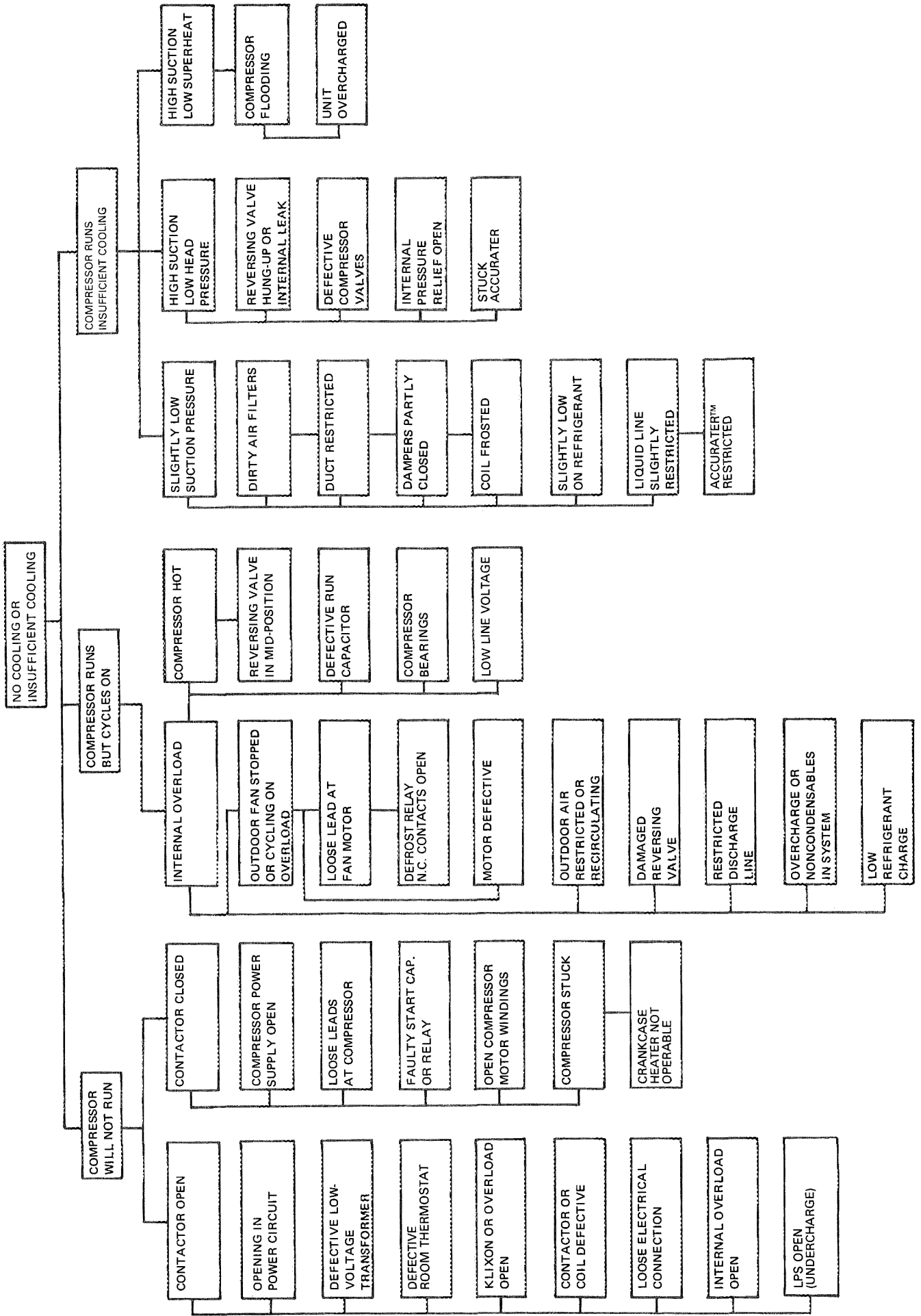

TROUBLESHOOTING CHART — HEATING CYCLE

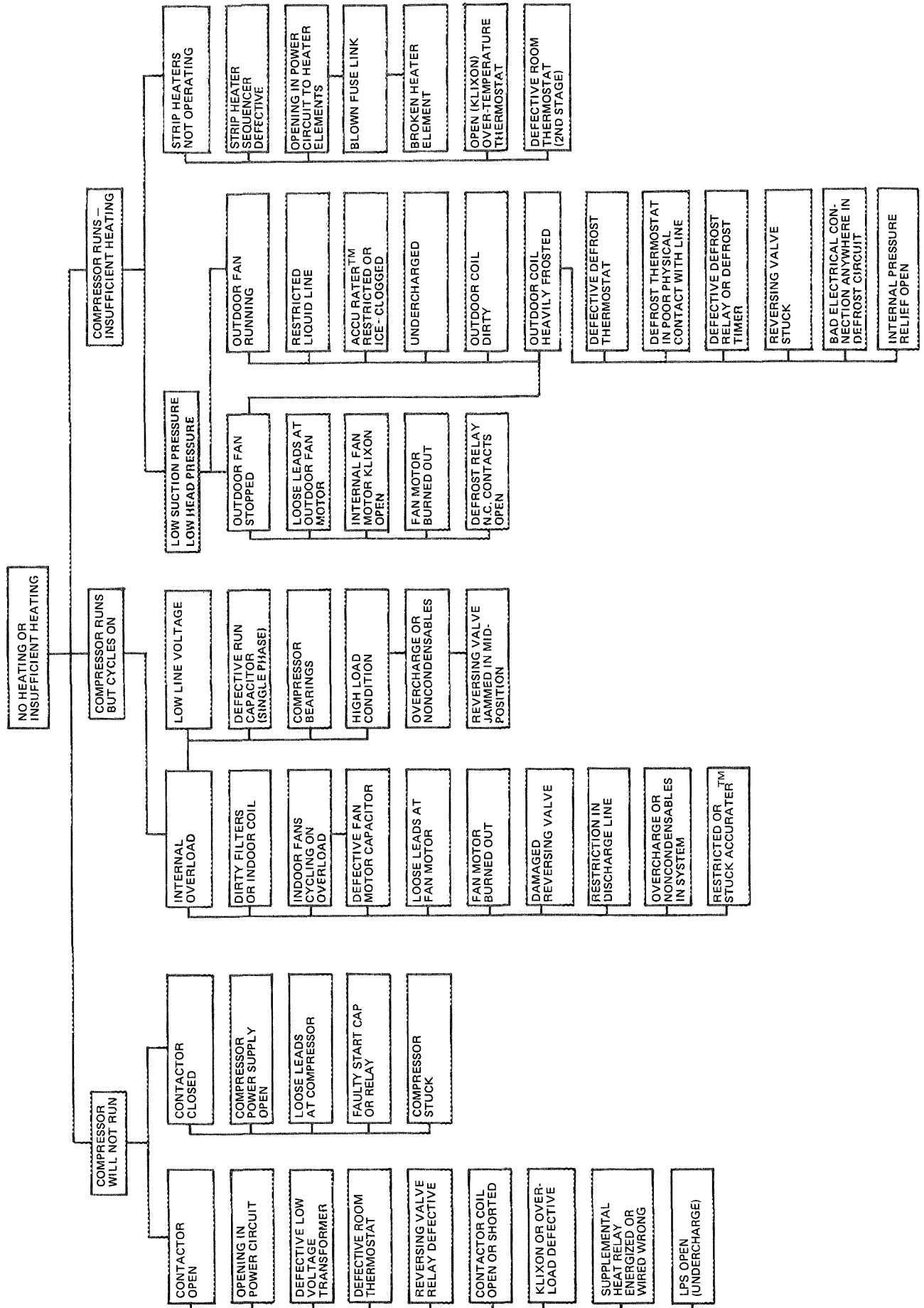

For replacement items use Carrier Specified Parts

Manufacturer reserves the right to discontinue, or change at any time, specifications or designs without notice and without incurring obligations.

| | | |
|------|----|----|
| Book | 1 | 4 |
| Tab | 5a | 5a |